

AIR CONDITIONING SYSTEMS

CITY MULTI



DATA BOOK

MODEL

PQRY-P72-336T(S)LMU-A1

PQRY-P72-336Y(S)LMU-A1



Water Cooled WR2-Series - 208-230V



Type(BTU/h)	72K	96K	120K
Model Name	PQRY-P72TLMU-A1	PQRY-P96TLMU-A1	PQRY-P120TLMU-A1



Type(BTU/h)	144K	168K	192K
Model Name	PQRY-P144TLMU-A1	PQRY-P168TLMU-A1	PQRY-P192TLMU-A1
Type(BTU/h)	216K	240K	
Model Name	PQRY-P216TLMU-A1	PQRY-P240TLMU-A1	



Type(BTU/h)	144K	168K	192K
Model Name	PQRY-P144TSLMU-A1	PQRY-P168TSLMU-A1	PQRY-P192TSLMU-A1
Type(BTU/h)	216K	240K	
Model Name	PQRY-P216TSLMU-A1	PQRY-P240TSLMU-A1	



Type(BTU/h)	288K	312K	336K
Model Name	PQRY-P288TSLMU-A1	PQRY-P312TSLMU-A1	PQRY-P336TSLMU-A1

Water Cooled WR2-Series - 460V



Type(BTU/h)	72K	96K	120K
Model Name	PQRY-P72YLMU-A1	PQRY-P96YLMU-A1	PQRY-P120YLMU-A1



Type(BTU/h)	144K	168K	192K
Model Name	PQRY-P144YLMU-A1	PQRY-P168YLMU-A1	PQRY-P192YLMU-A1
Type(BTU/h)	216K	240K	
Model Name	PQRY-P216YLMU-A1	PQRY-P240YLMU-A1	



Type(BTU/h)	144K	168K	192K
Model Name	PQRY-P144YSLMU-A1	PQRY-P168YSLMU-A1	PQRY-P192YSLMU-A1
Type(BTU/h)	216K	240K	
Model Name	PQRY-P216YSLMU-A1	PQRY-P240YSLMU-A1	



Type(BTU/h)	288K	312K	336K
Model Name	PQRY-P288YSLMU-A1	PQRY-P312YSLMU-A1	PQRY-P336YSLMU-A1

PQRY-P-T(S)LMU-A1, PQRY-P-Y(S)LMU-A1

1. SPECIFICATIONS	2
1-1. AHRI 1230-2014 condition.....	2
1-2. AHRI 1230-2021 condition.....	34
2. EXTERNAL DIMENSIONS	66
3. CENTER OF GRAVITY	76
4. ELECTRICAL WIRING DIAGRAMS	77
5. SOUND LEVELS	81
6. OPERATION TEMPERATURE RANGE.....	85
7. CAPACITY TABLES	86
7-1. Correction by temperature	86
7-2. Correction by total indoor.....	118
7-3. Correction by refrigerant piping length.....	124
8. SYSTEM DESIGN GUIDE.....	128
8-1. Designing of water circuit system	128
8-2. Water piping work	146
9. OPTIONAL PARTS.....	150
9-1. JOINT and REDUCER.....	150
9-2. OUTDOOR TWINNING KIT.....	154
9-3. JOINT KIT "CMY-R160-J1" FOR BC CONTROLLER	155
10.ELECTRICAL WORK	156
10-1.General cautions	156
10-2.Power supply for Heat source unit.....	157
10-3.Power cable specifications	158
10-4.Power supply examples.....	159
11.M-NET CONTROL	161
11-1.Transmission cable length limitation.....	161
11-2.Transmission cable specifications	162
11-3.System configuration restrictions.....	163
11-4.Address setting.....	167
12.PIPING DESIGN	178
12-1.R410A Piping material.....	178
12-2.Piping Design	179
12-3.Refrigerant charging calculation	185
12-4.Compatibility	189
13.INSTALLATION	190
13-1.General requirements for installation.....	190
13-2.Spacing.....	190
13-3.Piping direction	191

1-1. AHRI 1230-2014 condition

PQRY-P-T(S)LMU-A1, Y(S)LMU-A1

Heat Source Model			PQRY-P72TLMU-A1		
Indoor Model			Non-Ducted	Ducted	
Power source			3-phase 3-wire 208-230 V ±10% 60 Hz		
Cooling capacity (Nominal)	*1	BTU/h	72,000		
		kW	21.1		
	(208-230)	Power input	3.61		
		Current input	11.1-10.0		
	(Rated)	BTU/h	69,000		
		kW	20.2		
	(208-230)	Power input	3.34	3.12	
		Current input	10.3-9.3	9.6-8.7	
	Temp. range of cooling	Indoor	W.B.	59~75°F (15~24°C)	
		Inlet water	°F	50~113°F (10~45°C)	
Heating capacity (Nominal)	*2	BTU/h	80,000		
		kW	23.4		
	(208-230)	Power input	4.04		
		Current input	12.4-11.2		
	(Rated)	BTU/h	76,000		
		kW	22.3		
	(208-230)	Power input	3.74	3.36	
		Current input	11.5-10.4	10.3-9.3	
	Temp. range of heating	Indoor	D.B.	59~81°F (15~27°C)	
		Inlet water	°F	50~113°F (10~45°C)	
Indoor unit connectable	Total capacity	50~150% of heat source unit capacity			
	Model/Quantity	P04-P96/1~18			
Sound pressure level (measured in anechoic room)	dB <A>	46.0			
Refrigerant piping diameter	High pressure	in. (mm)	5/8 (15.88) Brazed		
	Low pressure	in. (mm)	3/4 (19.05) Brazed		
Minimum Circuit Ampacity	A	13-12			
Maximum Overcurrent Protection	A	20-20			
Circulating water	Water flow rate	G/h	1,522		
		G/min	25.4		
		m ³ /h	5.76		
		L/min	96		
		cfm	3.4		
	Pressure drop	psi	3.48		
		kPa	24		
	Operating volume range	G/h	793 ~ 1,902		
		G/min	13.2 ~ 31.7		
		m ³ /h	3.0 ~ 7.2		
Compressor	Type x Quantity	Inverter scroll hermetic compressor x 1			
	Starting method	Inverter			
	Motor output	kW	4.3		
	Case heater	kW	-		
	Lubricant	MEL32			
External finish	Galvanized steel sheets				
External dimension H x W x D	in.	43-5/16 x 34-11/16 x 21-11/16			
	mm	1,100 x 880 x 550			
Protection devices	High pressure protection	High pressure sensor, High pressure switch at 4.15 MPa (601 psi)			
	Inverter circuit	Over-heat protection, Over-current protection			
	Compressor	Over-heat protection			
Refrigerant	Type x original charge	R410A x 11 lbs + 1 oz (5.0 kg)			
	Control	Indoor LEV and BC controller			
Net weight	lbs (kg)	382 (173)			
Heat exchanger	plate type				
	Water volume in plate	G	1.32		
		l	5.0		
	Water pressure Max.	psi	290		
MPa		2.0			
HIC circuit (HIC: Heat Inter-Changer)	-				
Drawing	External	KL94C207			
	Wiring	KE94G422			
Standard attachment	Document	Installation Manual			
	Accessory	Details refer to External Drw			
Optional parts	joint: CMY-Y102SS-G2,CMY-Y102LS-G2,CMY-R160-J1 BC controller: CMB-P104,106,108,1012,1016NU-J1 Main BC controller: CMB-P108,1012,1016NU-JA1,CMB-P1016NU-KA1 Sub BC controller: CMB-P104,108NU-KB1				
Remarks	Details on foundation work, duct work, insulation work, electrical wiring, power source switch, and other items shall be referred to the Installation Manual. Due to continuing improvement, above specifications may be subject to change without notice. The ambient temperature of the Heat Source Unit needs to be kept below 104°F.D.B. (40°C.D.B.) The ambient relative humidity of the Heat Source Unit needs to be kept below 80%. The Heat Source Unit should not be installed at outdoor. Be sure to mount a strainer (more than 50 meshes) at the water inlet piping of the unit. Be sure to provide interlocking for the unit operation and water circuit. Install the supplied insulation material to the unused drain-socket. When installing insulation material around both water and refrigerant piping, follow the installation manual. The cooling tower and the water circuit must be a closed circuit (water is not exposed to the atmosphere).				

Notes:	Unit converter
1.Nominal cooling conditions (Test conditions are based on AHRI 1230) Indoor: 81°F.D.B./66°F.W.B. (27°C.D.B./19°C.W.B.), Inlet water temperature: 86°F (30°C)	BTU/h =kW x 3,412
2.Nominal heating conditions (Test conditions are based on AHRI 1230) Indoor: 68°F.D.B. (20°C.D.B.), Inlet water temperature: 68°F (20°C)	cfm =m ³ /min x 35.31
	lbs =kg/0.4536
	*Above specification data is subject to rounding variation.

1. SPECIFICATIONS

Heat Source Model		PQR-Y-P96TLMU-A1		
Indoor Model		Non-Ducted	Ducted	
Power source		3-phase 3-wire 208-230 V ±10% 60 Hz		
Cooling capacity (Nominal)	*1	BTU/h	96,000	
		kW	28.1	
	Power input	kW	5.21	
		A	16.0-14.5	
	(Rated)	(208-230)	BTU/h	92,000
			kW	27.0
Current input	kW	4.82	5.19	
	A	14.8-13.4	16.0-14.4	
Temp. range of cooling	Indoor	W.B.	59~75°F (15~24°C)	
	Inlet water	°F	50~113°F (10~45°C)	
Heating capacity (Nominal)	*2	BTU/h	108,000	
		kW	31.7	
	Power input	kW	5.64	
		A	17.3-15.7	
	(Rated)	(208-230)	BTU/h	103,000
			kW	30.2
Current input	kW	5.21	4.48	
	A	16.0-14.5	13.8-12.4	
Temp. range of heating	Indoor	D.B.	59~81°F (15~27°C)	
	Inlet water	°F	50~113°F (10~45°C)	
Indoor unit connectable	Total capacity	50~150% of heat source unit capacity		
	Model/Quantity	P04~P96/1~24		
Sound pressure level (measured in anechoic room)	dB <A>	48.0		
Refrigerant piping diameter	High pressure	in. (mm)	3/4 (19.05) Brazed	
	Low pressure	in. (mm)	7/8 (22.2) Brazed	
Minimum Circuit Ampacity	A	19-17		
Maximum Overcurrent Protection	A	30-25		
Circulating water	Water flow rate	G/h	1,522	
		G/min	25.4	
		m ³ /h	5.76	
		L/min	96	
		cfm	3.4	
	Pressure drop	psi	3.48	
		kPa	24	
	Operating volume range	G/h	793 ~ 1,902	
		G/min	13.2 ~ 31.7	
		m ³ /h	3.0 ~ 7.2	
Compressor	Type x Quantity	Inverter scroll hermetic compressor x 1		
	Starting method	Inverter		
	Motor output	kW	6.0	
	Case heater	kW	-	
	Lubricant	MEL32		
External finish	Galvanized steel sheets			
External dimension H x W x D	in.	43-5/16 x 34-11/16 x 21-11/16		
	mm	1,100 x 880 x 550		
Protection devices	High pressure protection	High pressure sensor, High pressure switch at 4.15 MPa (601 psi)		
	Inverter circuit	Over-heat protection, Over-current protection		
	Compressor	Over-heat protection		
Refrigerant	Type x original charge	R410A x 11 lbs + 1 oz (5.0 kg)		
	Control	Indoor LEV and BC controller		
Net weight	lbs (kg)	382 (173)		
Heat exchanger	Water volume in plate	G	plate type	
		l	1.32	
	Water pressure Max.	psi	5.0	
		MPa	290	
HIC circuit (HIC: Heat Inter-Changer)		2.0		
Drawing	External	KL94C207		
	Wiring	KE94G422		
Standard attachment	Document	Installation Manual		
	Accessory	Details refer to External Drw		
Optional parts	joint: CMY-Y102SS-G2, CMY-Y102LS-G2, CMY-R160-J1 BC controller: CMB-P104, 106, 108, 1012, 1016NU-J1 Main BC controller: CMB-P108, 1012, 1016NU-JA1, CMB-P1016NU-KA1 Sub BC controller: CMB-P104, 108NU-KB1			
Remarks	Details on foundation work, duct work, insulation work, electrical wiring, power source switch, and other items shall be referred to the Installation Manual. Due to continuing improvement, above specifications may be subject to change without notice. The ambient temperature of the Heat Source Unit needs to be kept below 104°F.D.B. (40°C.D.B.) The ambient relative humidity of the Heat Source Unit needs to be kept below 80%. The Heat Source Unit should not be installed at outdoor. Be sure to mount a strainer (more than 50 meshes) at the water inlet piping of the unit. Be sure to provide interlocking for the unit operation and water circuit. Install the supplied insulation material to the unused drain-socket. When installing insulation material around both water and refrigerant piping, follow the installation manual. The cooling tower and the water circuit must be a closed circuit (water is not exposed to the atmosphere).			

Notes: 1.Nominal cooling conditions (Test conditions are based on AHRI 1230) Indoor: 81°F.D.B./66°F.W.B. (27°C.D.B./19°C.W.B.), Inlet water temperature: 86°F (30°C) 2.Nominal heating conditions (Test conditions are based on AHRI 1230) Indoor: 68°F.D.B. (20°C.D.B.), Inlet water temperature: 68°F (20°C)	Unit converter
	BTU/h =kW x 3,412
	cfm =m ³ /min x 35.31
	lbs =kg/0.4536
*Above specification data is subject to rounding variation.	

1. SPECIFICATIONS

PQRY-P-T(S)LMU-A1, Y(S)LMU-A1

Heat Source Model		PQRY-P120TLMU-A1		
Indoor Model		Non-Ducted	Ducted	
Power source		3-phase 3-wire 208-230 V ±10% 60 Hz		
Cooling capacity (Nominal)	*1	BTU/h	120,000	
		kW	35.2	
	Power input	kW	7.51	
		A	23.1-20.9	
	(Rated) (208-230)		BTU/h	114,000
			kW	33.4
Power input		kW	6.95	
		A	21.4-19.3	
Temp. range of cooling	Indoor	W.B.	59~75°F (15~24°C)	
	Inlet water	°F	50~113°F (10~45°C)	
Heating capacity (Nominal)	*2	BTU/h	135,000	
		kW	39.6	
	Power input	kW	7.09	
		A	21.8-19.7	
	(Rated) (208-230)		BTU/h	129,000
			kW	37.8
Power input		kW	6.55	
		A	20.2-18.2	
Temp. range of heating	Indoor	D.B.	59~81°F (15~27°C)	
	Inlet water	°F	50~113°F (10~45°C)	
Indoor unit connectable	Total capacity	50~150% of heat source unit capacity		
	Model/Quantity	P04~P96/1~30		
Sound pressure level (measured in anechoic room)	dB <A>	54.0		
Refrigerant piping diameter	High pressure	in. (mm)	3/4 (19.05) Brazed	
	Low pressure	in. (mm)	7/8 (22.2) Brazed	
Minimum Circuit Ampacity	A	29-26		
Maximum Overcurrent Protection	A	50-45		
Circulating water	Water flow rate	G/h	1,522	
		G/min	25.4	
		m ³ /h	5.76	
		L/min	96	
		cfm	3.4	
	Pressure drop	psi	3.48	
		kPa	24	
	Operating volume range	G/h	793 ~ 1,902	
G/min		13.2 ~ 31.7		
m ³ /h		3.0 ~ 7.2		
Compressor	Type x Quantity	Inverter scroll hermetic compressor x 1		
	Starting method	Inverter		
	Motor output	kW	7.7	
	Case heater	kW	-	
	Lubricant	MEL32		
External finish	Galvanized steel sheets			
External dimension H x W x D	in.	43-5/16 x 34-11/16 x 21-11/16		
	mm	1,100 x 880 x 550		
Protection devices	High pressure protection	High pressure sensor, High pressure switch at 4.15 MPa (601 psi)		
	Inverter circuit	Over-heat protection, Over-current protection		
	Compressor	Over-heat protection		
Refrigerant	Type x original charge	R410A x 11 lbs + 1 oz (5.0 kg)		
	Control	Indoor LEV and BC controller		
Net weight	lbs (kg)	382 (173)		
Heat exchanger	Water volume in plate	G	1.32	
		l	5.0	
	Water pressure Max.	psi	290	
		MPa	2.0	
HIC circuit (HIC: Heat Inter-Changer)	-			
Drawing	External	KL94C207		
	Wiring	KE94G422		
Standard attachment	Document	Installation Manual		
	Accessory	Details refer to External Drw		
Optional parts	joint: CMY-Y102SS-G2, CMY-Y102LS-G2, CMY-R160-J1 BC controller: CMB-P104, 106, 108, 1012, 1016NU-J1 Main BC controller: CMB-P108, 1012, 1016NU-JA1, CMB-P1016NU-KA1 Sub BC controller: CMB-P104, 108NU-KB1			
Remarks	Details on foundation work, duct work, insulation work, electrical wiring, power source switch, and other items shall be referred to the Installation Manual. Due to continuing improvement, above specifications may be subject to change without notice. The ambient temperature of the Heat Source Unit needs to be kept below 104°F.D.B. (40°C.D.B.) The ambient relative humidity of the Heat Source Unit needs to be kept below 80%. The Heat Source Unit should not be installed at outdoor. Be sure to mount a strainer (more than 50 meshes) at the water inlet piping of the unit. Be sure to provide interlocking for the unit operation and water circuit. Install the supplied insulation material to the unused drain-socket. When installing insulation material around both water and refrigerant piping, follow the installation manual. The cooling tower and the water circuit must be a closed circuit (water is not exposed to the atmosphere).			

Notes:	Unit converter
1.Nominal cooling conditions (Test conditions are based on AHRI 1230) Indoor: 81°F.D.B./66°F.W.B. (27°C.D.B./19°C.W.B.), Inlet water temperature: 86°F (30°C)	BTU/h =kW x 3,412
2.Nominal heating conditions (Test conditions are based on AHRI 1230) Indoor: 68°F.D.B. (20°C.D.B.), Inlet water temperature: 68°F (20°C)	cfm =m ³ /min x 35.31
	lbs =kg/0.4536
	*Above specification data is subject to rounding variation.

1. SPECIFICATIONS

Heat Source Model		PQRY-P144TLMU-A1		
Indoor Model		Non-Ducted	Ducted	
Power source		3-phase 3-wire 208-230 V ±10% 60 Hz		
Cooling capacity (Nominal)	*1	BTU/h	144,000	
		kW	42.2	
	Power input	kW	8.78	
		A	27.0-24.4	
	(Rated)	(208-230)	BTU/h	137,000
			kW	40.2
Current input	kW	8.07	9.98	
	A	24.8-22.5	30.7-27.8	
Temp. range of cooling	Indoor	W.B.	59~75°F (15~24°C)	
	Inlet water	°F	50~113°F (10~45°C)	
Heating capacity (Nominal)	*2	BTU/h	160,000	
		kW	46.9	
	Power input	kW	8.11	
		A	25.0-22.6	
	(Rated)	(208-230)	BTU/h	152,000
			kW	44.5
Current input	kW	7.47	7.90	
	A	23.0-20.8	24.3-22.0	
Temp. range of heating	Indoor	D.B.	59~81°F (15~27°C)	
	Inlet water	°F	50~113°F (10~45°C)	
Indoor unit connectable	Total capacity	50~150% of heat source unit capacity		
	Model/Quantity	P04~P96/1~36		
Sound pressure level (measured in anechoic room)	dB <A>	54.0		
Refrigerant piping diameter	High pressure	in. (mm)		
	Low pressure	in. (mm)		
Minimum Circuit Ampacity	A	35-32		
Maximum Overcurrent Protection	A	60-50		
Circulating water	Water flow rate	G/h	1,902	
		G/min	31.7	
		m ³ /h	7.20	
		L/min	120	
		cfm	4.2	
	Pressure drop	psi	6.38	
		kPa	44	
	Operating volume range	G/h	1,189 ~ 3,054	
G/min		19.8 ~ 50.9		
m ³ /h		4.5 ~ 11.6		
Compressor	Type x Quantity	Inverter scroll hermetic compressor x 1		
	Starting method	Inverter		
	Motor output	kW	9.5	
	Case heater	kW	-	
	Lubricant	MEL32		
External finish	Galvanized steel sheets			
External dimension H x W x D	in.	57-1/8 x 34-11/16 x 21-11/16		
	mm	1,450 x 880 x 550		
Protection devices	High pressure protection	High pressure sensor, High pressure switch at 4.15 MPa (601 psi)		
	Inverter circuit	Over-heat protection, Over-current protection		
	Compressor	Over-heat protection		
Refrigerant	Type x original charge	R410A x 13 lbs + 4 oz (6.0 kg)		
	Control	Indoor LEV and BC controller		
Net weight	lbs (kg)	481 (218)		
Heat exchanger	Water volume in plate	G	1.32	
		l	5.0	
	Water pressure Max.	psi	290	
		MPa	2.0	
HIC circuit (HIC: Heat Inter-Changer)	-			
Drawing	External	KL94C208		
	Wiring	KE94G423		
Standard attachment	Document	Installation Manual		
	Accessory	Details refer to External Drw		
Optional parts	joint: CMY-Y102SS-G2,CMY-Y102LS-G2,CMY-R160-J1 Main BC controller: CMB-P108,1012,1016NU-JA1,CMB-P1016NU-KA1 Sub BC controller: CMB-P104,108NU-KB1			
Remarks	Details on foundation work, duct work, insulation work, electrical wiring, power source switch, and other items shall be referred to the Installation Manual. Due to continuing improvement, above specifications may be subject to change without notice. The ambient temperature of the Heat Source Unit needs to be kept below 104°F.D.B. (40°C.D.B.) The ambient relative humidity of the Heat Source Unit needs to be kept below 80%. The Heat Source Unit should not be installed at outdoor. Be sure to mount a strainer (more than 50 meshes) at the water inlet piping of the unit. Be sure to provide interlocking for the unit operation and water circuit. Install the supplied insulation material to the unused drain-socket. When installing insulation material around both water and refrigerant piping, follow the installation manual. The cooling tower and the water circuit must be a closed circuit (water is not exposed to the atmosphere).			

Notes:	Unit converter
1.Nominal cooling conditions (Test conditions are based on AHRI 1230) Indoor: 81°F.D.B./66°F.W.B. (27°C.D.B./19°C.W.B.), Inlet water temperature: 86°F (30°C)	BTU/h =kW x 3,412
2.Nominal heating conditions (Test conditions are based on AHRI 1230) Indoor: 68°F.D.B. (20°C.D.B.), Inlet water temperature: 68°F (20°C)	cfm =m ³ /min x 35.31
	lbs =kg/0.4536
	*Above specification data is subject to rounding variation.

1. SPECIFICATIONS

WR2-Series

PQRY-P-T(S)LMU-A1, Y(S)LMU-A1

Heat Source Model			PQRY-P168TLMU-A1	
Indoor Model			Non-Ducted	Ducted
Power source			3-phase 3-wire 208-230 V ±10% 60 Hz	
Cooling capacity (Nominal)	*1	BTU/h	168,000	
		kW	49.2	
	(208-230)	Power input	12.05	
		Current input	37.1-33.6	
	(Rated)	BTU/h	161,000	
		kW	47.2	
(208-230)	Power input	11.10	11.88	
	Current input	34.2-30.9	36.6-33.1	
Temp. range of cooling	Indoor	W.B.	59~75°F (15~24°C)	
	Inlet water	°F	50~113°F (10~45°C)	
Heating capacity (Nominal)	*2	BTU/h	188,000	
		kW	55.1	
	(208-230)	Power input	9.86	
		Current input	30.4-27.5	
	(Rated)	BTU/h	179,000	
		kW	52.5	
(208-230)	Power input	9.09	9.72	
	Current input	28.0-25.3	29.9-27.1	
Temp. range of heating	Indoor	D.B.	59~81°F (15~27°C)	
	Inlet water	°F	50~113°F (10~45°C)	
Indoor unit connectable	Total capacity	50~150% of heat source unit capacity		
	Model/Quantity	P04~P96/1~42		
Sound pressure level (measured in anechoic room)	dB <A>	56.0		
Refrigerant piping diameter	High pressure	in. (mm)	7/8 (22.2) Brazed	
	Low pressure	in. (mm)	1-1/8 (28.58) Brazed	
Minimum Circuit Ampacity	A	44-39		
Maximum Overcurrent Protection	A	70-70		
Circulating water	Water flow rate	G/h	1,902	
		G/min	31.7	
		m ³ /h	7.20	
		L/min	120	
		cfm	4.2	
	Pressure drop	psi	6.38	
		kPa	44	
	Operating volume range	G/h	1,189 ~ 3,054	
G/min		19.8 ~ 50.9		
m ³ /h		4.5 ~ 11.6		
Compressor	Type x Quantity	Inverter scroll hermetic compressor x 1		
	Starting method	Inverter		
	Motor output	kW	11.0	
	Case heater	kW	-	
	Lubricant	MEL32		
External finish	Galvanized steel sheets			
External dimension H x W x D	in.	57-1/8 x 34-11/16 x 21-11/16		
	mm	1,450 x 880 x 550		
Protection devices	High pressure protection	High pressure sensor, High pressure switch at 4.15 MPa (601 psi)		
	Inverter circuit	Over-heat protection, Over-current protection		
	Compressor	Over-heat protection		
Refrigerant	Type x original charge	R410A x 13 lbs + 4 oz (6.0 kg)		
	Control	Indoor LEV and BC controller		
Net weight	lbs (kg)	481 (218)		
Heat exchanger	Water volume in plate	G	plate type	
		l	1.32	
	Water pressure Max.	psi	5.0	
		MPa	290	
HIC circuit (HIC: Heat Inter-Changer)	-			
Drawing	External	KL94C208		
	Wiring	KE94G423		
Standard attachment	Document	Installation Manual		
	Accessory	Details refer to External Drw		
Optional parts	joint: CMY-Y102SS-G2, CMY-Y102LS-G2, CMY-R160-J1 Main BC controller: CMB-P108, 1012, 1016NU-JA1, CMB-P1016NU-KA1 Sub BC controller: CMB-P104, 108NU-KB1			
Remarks	Details on foundation work, duct work, insulation work, electrical wiring, power source switch, and other items shall be referred to the Installation Manual. Due to continuing improvement, above specifications may be subject to change without notice. The ambient temperature of the Heat Source Unit needs to be kept below 104°F.D.B. (40°C.D.B.) The ambient relative humidity of the Heat Source Unit needs to be kept below 80%. The Heat Source Unit should not be installed at outdoor. Be sure to mount a strainer (more than 50 meshes) at the water inlet piping of the unit. Be sure to provide interlocking for the unit operation and water circuit. Install the supplied insulation material to the unused drain-socket. When installing insulation material around both water and refrigerant piping, follow the installation manual. The cooling tower and the water circuit must be a closed circuit (water is not exposed to the atmosphere).			

Notes:	Unit converter
1.Nominal cooling conditions (Test conditions are based on AHRI 1230) Indoor: 81°F.D.B./66°F.W.B. (27°C.D.B./19°C.W.B.), Inlet water temperature: 86°F (30°C)	BTU/h =kW x 3,412
2.Nominal heating conditions (Test conditions are based on AHRI 1230) Indoor: 68°F.D.B. (20°C.D.B.), Inlet water temperature: 68°F (20°C)	cfm =m ³ /min x 35.31
	lbs =kg/0.4536
	*Above specification data is subject to rounding variation.

1. SPECIFICATIONS

Heat Source Model		PQR-Y-P192TLMU-A1		
Indoor Model		Non-Ducted	Ducted	
Power source		3-phase 3-wire 208-230 V ±10% 60 Hz		
Cooling capacity (Nominal)	*1	BTU/h	192,000	
		kW	56.3	
	(208-230)	Power input	15.05	
		Current input	46.4-41.9	
	(Rated)	BTU/h	183,000	
		kW	53.6	
(208-230)	Power input	13.87	14.19	
	Current input	42.7-38.6	43.7-39.5	
Temp. range of cooling	Indoor	W.B.	59~75°F (15~24°C)	
	Inlet water	°F	50~113°F (10~45°C)	
Heating capacity (Nominal)	*2	BTU/h	215,000	
		kW	63.0	
	(208-230)	Power input	11.90	
		Current input	36.7-33.1	
	(Rated)	BTU/h	205,000	
		kW	60.1	
(208-230)	Power input	10.97	11.56	
	Current input	33.8-30.5	35.6-32.2	
Temp. range of heating	Indoor	D.B.	59~81°F (15~27°C)	
	Inlet water	°F	50~113°F (10~45°C)	
Indoor unit connectable	Total capacity	50~150% of heat source unit capacity		
	Model/Quantity	P04~P96/1~48		
Sound pressure level (measured in anechoic room)		dB <A>	58.0	
Refrigerant piping diameter	High pressure	in. (mm)	7/8 (22.2) Brazed	
	Low pressure	in. (mm)	1-1/8 (28.58) Brazed	
Minimum Circuit Ampacity		A	54-49	
Maximum Overcurrent Protection		A	90-80	
Circulating water	Water flow rate	G/h	1,902	
		G/min	31.7	
		m ³ /h	7.20	
		L/min	120	
		cfm	4.2	
	Pressure drop	psi	6.38	
		kPa	44	
	Operating volume range	G/h	1,189 ~ 3,054	
G/min		19.8 ~ 50.9		
m ³ /h		4.5 ~ 11.6		
Compressor	Type x Quantity	Inverter scroll hermetic compressor x 1		
	Starting method	Inverter		
	Motor output	kW	12.4	
	Case heater	kW	-	
	Lubricant	MEL32		
External finish		Galvanized steel sheets		
External dimension H x W x D	in.	57-1/8 x 34-11/16 x 21-11/16		
	mm	1,450 x 880 x 550		
Protection devices	High pressure protection	High pressure sensor, High pressure switch at 4.15 MPa (601 psi)		
	Inverter circuit	Over-heat protection, Over-current protection		
	Compressor	Over-heat protection		
Refrigerant	Type x original charge	R410A x 13 lbs + 4 oz (6.0 kg)		
	Control	Indoor LEV and BC controller		
Net weight	lbs (kg)	481 (218)		
Heat exchanger			plate type	
	Water volume in plate	G	1.32	
		l	5.0	
	Water pressure Max.	psi	290	
MPa		2.0		
HIC circuit (HIC: Heat Inter-Changer)		-		
Drawing	External	KL94C208		
	Wiring	KE94G423		
Standard attachment	Document	Installation Manual		
	Accessory	Details refer to External Drw		
Optional parts		joint: CMY-Y102SS-G2, CMY-Y102LS-G2, CMY-R160-J1 Main BC controller: CMB-P108, 1012, 1016NU-JA1, CMB-P1016NU-KA1 Sub BC controller: CMB-P104, 108NU-KB1		
Remarks	Details on foundation work, duct work, insulation work, electrical wiring, power source switch, and other items shall be referred to the Installation Manual. Due to continuing improvement, above specifications may be subject to change without notice. The ambient temperature of the Heat Source Unit needs to be kept below 104°F D.B. (40°C D.B.). The ambient relative humidity of the Heat Source Unit needs to be kept below 80%. The Heat Source Unit should not be installed at outdoor. Be sure to mount a strainer (more than 50 meshes) at the water inlet piping of the unit. Be sure to provide interlocking for the unit operation and water circuit. Install the supplied insulation material to the unused drain-socket. When installing insulation material around both water and refrigerant piping, follow the installation manual. The cooling tower and the water circuit must be a closed circuit (water is not exposed to the atmosphere).			

Notes:	Unit converter
1. Nominal cooling conditions (Test conditions are based on AHRI 1230) Indoor: 81°F D.B./66°F W.B. (27°C D.B./19°C W.B.), Inlet water temperature: 86°F (30°C)	BTU/h = kW x 3,412
2. Nominal heating conditions (Test conditions are based on AHRI 1230) Indoor: 68°F D.B. (20°C D.B.), Inlet water temperature: 68°F (20°C)	cfm = m ³ /min x 35.31
	lbs = kg/0.4536
	*Above specification data is subject to rounding variation.

1. SPECIFICATIONS

WR2-Series

PQRY-P-T(S)LMU-A1, Y(S)LMU-A1

Heat Source Model			PQRY-P216TLMU-A1		
Indoor Model			Non-Ducted	Ducted	
Power source			3-phase 3-wire 208-230 V ±10% 60 Hz		
Cooling capacity (Nominal)	*1	BTU/h	216,000		
		kW	63.3		
	(208-230)	Power input	kW	19.23	
		Current input	A	59.3-53.6	
	(Rated)	BTU/h	206,000		
		kW	60.4		
	(208-230)	Power input	kW	17.72	16.10
		Current input	A	54.6-49.4	49.6-44.9
Temp. range of cooling	Indoor	W.B.	59~75°F (15~24°C)		
	Inlet water	°F	50~113°F (10~45°C)		
Heating capacity (Nominal)	*2	BTU/h	243,000		
		kW	71.2		
	(208-230)	Power input	kW	13.04	
		Current input	A	40.2-36.3	
	(Rated)	BTU/h	232,000		
		kW	68.0		
	(208-230)	Power input	kW	12.01	12.34
		Current input	A	37.0-33.4	38.0-34.4
Temp. range of heating	Indoor	D.B.	59~81°F (15~27°C)		
	Inlet water	°F	50~113°F (10~45°C)		
Indoor unit connectable	Total capacity	50~150% of heat source unit capacity			
	Model/Quantity	P04~P96/2~50 (Connectable branch pipe number is max. 48.)			
Sound pressure level (measured in anechoic room)		dB <A>	58.0		
Refrigerant piping diameter	High pressure	in. (mm)	7/8 (22.2) Braze (1-1/8 (28.58) Braze for the part that exceeds 65 m)		
	Low pressure	in. (mm)	1-1/8 (28.58) Braze		
Minimum Circuit Ampacity		A	69-63		
Maximum Overcurrent Protection		A	110-110		
Circulating water	Water flow rate	G/h	3,044		
		G/min	50.7		
		m ³ /h	11.52		
		L/min	192		
		cfm	6.8		
	Pressure drop	psi	6.53		
		kPa	45		
	Operating volume range	G/h	1,585 ~ 3,804		
G/min		26.4 ~ 63.4			
m ³ /h		6.0 ~ 14.4			
Compressor	Type x Quantity	Inverter scroll hermetic compressor x 1			
	Starting method	Inverter			
	Motor output	kW	14.5		
	Case heater	kW	0.045		
	Lubricant	MEL32			
External finish		Galvanized steel sheets			
External dimension H x W x D		in.	57-1/8 x 34-11/16 x 21-11/16		
		mm	1,450 x 880 x 550		
Protection devices	High pressure protection	High pressure sensor, High pressure switch at 4.15 MPa (601 psi)			
	Inverter circuit	Over-heat protection, Over-current protection			
	Compressor	Over-heat protection			
Refrigerant	Type x original charge	R410A x 25 lbs + 13 oz (11.7 kg)			
	Control	Indoor LEV and BC controller			
Net weight		lbs (kg)	558 (253)		
Heat exchanger	Water volume in plate	G	plate type		
		l	2.64		
	Water pressure Max.	psi	290		
		MPa	2.0		
HIC circuit (HIC: Heat Inter-Changer)		-			
Drawing	External	KL94C209			
	Wiring	KE94G426			
Standard attachment	Document	Installation Manual			
	Accessory	Details refer to External Drw			
Optional parts		joint: CMY-Y102SS-G2, CMY-Y102LS-G2, CMY-R160-J1 Main BC controller: CMB-P108, 1012, 1016NU-JA1, CMB-P1016NU-KA1 Sub BC controller: CMB-P104, 108NU-KB1			
Remarks		<p>Details on foundation work, duct work, insulation work, electrical wiring, power source switch, and other items shall be referred to the Installation Manual.</p> <p>Due to continuing improvement, above specifications may be subject to change without notice.</p> <p>The ambient temperature of the Heat Source Unit needs to be kept below 104°F.D.B. (40°C.D.B.)</p> <p>The ambient relative humidity of the Heat Source Unit needs to be kept below 80%.</p> <p>The Heat Source Unit should not be installed at outdoor.</p> <p>Be sure to mount a strainer (more than 50 meshes) at the water inlet piping of the unit.</p> <p>Be sure to provide interlocking for the unit operation and water circuit.</p> <p>Install the supplied insulation material to the unused drain-socket.</p> <p>When installing insulation material around both water and refrigerant piping, follow the installation manual.</p> <p>When the high pressure piping length is 65 m or less, use 7/8 (22.2) pipe. When the high pressure piping length exceeds 65 m, use 1-1/8 (28.58) pipe until 65 m, use 1-1/8 (28.58) pipe for the part that exceeds 65 m.</p> <p>The cooling tower and the water circuit must be a closed circuit (water is not exposed to the atmosphere).</p>			

Notes:	1.Nominal cooling conditions (Test conditions are based on AHRI 1230) Indoor: 81°F.D.B./66°F.W.B. (27°C.D.B./19°C.W.B.), Inlet water temperature: 86°F (30°C)	Unit converter
	2.Nominal heating conditions (Test conditions are based on AHRI 1230) Indoor: 68°F.D.B. (20°C.D.B.), Inlet water temperature: 68°F (20°C)	BTU/h =kW x 3.412
		cfm =m ³ /min x 35.31
		lbs =kg/0.4536
		*Above specification data is subject to rounding variation.

1. SPECIFICATIONS

Heat Source Model		PQR-P240TLMU-A1		
Indoor Model		Non-Ducted	Ducted	
Power source		3-phase 3-wire 208-230 V ±10% 60 Hz		
Cooling capacity (Nominal)	*1	BTU/h	224,000	
		kW	65.7	
	(208-230)	Power input	kW	21.14
		Current input	A	65.1-58.9
	(Rated)	BTU/h		228,000
		kW		66.8
(208-230)	Power input	kW	19.49	
	Current input	A	60.1-54.3	
Temp. range of cooling	Indoor	W.B.	59~75°F (15~24°C)	
	Inlet water	°F	50~113°F (10~45°C)	
Heating capacity (Nominal)	*2	BTU/h	270,000	
		kW	79.1	
	(208-230)	Power input	kW	15.12
		Current input	A	46.6-42.1
	(Rated)	BTU/h		258,000
		kW		75.6
(208-230)	Power input	kW	13.93	
	Current input	A	42.9-38.8	
Temp. range of heating	Indoor	D.B.	59~81°F (15~27°C)	
	Inlet water	°F	50~113°F (10~45°C)	
Indoor unit connectable	Total capacity	50~150% of heat source unit capacity		
	Model/Quantity	P04~P96/2~50 (Connectable branch pipe number is max. 48.)		
Sound pressure level (measured in anechoic room)		dB <A>		
Refrigerant piping diameter	High pressure	in. (mm)		
	Low pressure	in. (mm)		
Minimum Circuit Ampacity		A		
Maximum Overcurrent Protection		A		
Circulating water	Water flow rate	G/h	3,044	
		G/min	50.7	
		m ³ /h	11.52	
		L/min	192	
		cfm	6.8	
	Pressure drop	psi	6.53	
kPa		45		
Operating volume range	G/h	1,585 ~ 3,804		
	G/min	26.4 ~ 63.4		
	m ³ /h	6.0 ~ 14.4		
Compressor	Type x Quantity		Inverter scroll hermetic compressor x 1	
	Starting method		Inverter	
	Motor output	kW	16.1	
	Case heater	kW	0.045	
	Lubricant		MEL32	
External finish		Galvanized steel sheets		
External dimension H x W x D	in.		57-1/8 x 34-11/16 x 21-11/16	
	mm		1,450 x 880 x 550	
Protection devices	High pressure protection		High pressure sensor, High pressure switch at 4.15 MPa (601 psi)	
	Inverter circuit		Over-heat protection, Over-current protection	
	Compressor		Over-heat protection	
Refrigerant	Type x original charge		R410A x 25 lbs + 13 oz (11.7 kg)	
	Control		Indoor LEV and BC controller	
Net weight	lbs (kg)	558 (253)		
Heat exchanger	Water volume in plate		plate type	
	G		2.64	
	l		10.0	
	Water pressure Max.	psi		290
MPa		2.0		
HIC circuit (HIC: Heat Inter-Changer)		-		
Drawing	External		KL94C209	
	Wiring		KE94G426	
Standard attachment	Document		Installation Manual	
	Accessory		Details refer to External Drw	
Optional parts		joint: CMY-Y102SS-G2, CMY-Y102LS-G2, CMY-R160-J1 Main BC controller: CMB-P108, 1012, 1016NU-JA1, CMB-P1016NU-KA1 Sub BC controller: CMB-P104, 108NU-KB1		
Remarks		Details on foundation work, duct work, insulation work, electrical wiring, power source switch, and other items shall be referred to the Installation Manual. Due to continuing improvement, above specifications may be subject to change without notice. The ambient temperature of the Heat Source Unit needs to be kept below 104°F D.B. (40°C D.B.) The ambient relative humidity of the Heat Source Unit needs to be kept below 80%. The Heat Source Unit should not be installed at outdoor. Be sure to mount a strainer (more than 50 meshes) at the water inlet piping of the unit. Be sure to provide interlocking for the unit operation and water circuit. Install the supplied insulation material to the unused drain-socket. When installing insulation material around both water and refrigerant piping, follow the installation manual. When the high pressure piping length is 65 m or less, use 7/8 (22.2) pipe. When the high pressure piping length exceeds 65 m, use 1-1/8 (28.58) pipe for the part that exceeds 65 m. The cooling tower and the water circuit must be a closed circuit (water is not exposed to the atmosphere).		

Notes: 1.Nominal cooling conditions (Test conditions are based on AHRI 1230) Indoor: 81°F D.B./66°F W.B. (27°C D.B./19°C W.B.), Inlet water temperature: 86°F (30°C) 2.Nominal heating conditions (Test conditions are based on AHRI 1230) Indoor: 68°F D.B. (20°C D.B.), Inlet water temperature: 68°F (20°C)	Unit converter	
	BTU/h	=kW x 3,412
	cfm	=m ³ /min x 35.31
	lbs	=kg/0.4536
*Above specification data is subject to rounding variation.		

1. SPECIFICATIONS

WR2-Series

PQRY-P-T(S)LMU-A1, Y(S)LMU-A1

Heat Source Model			PQRY-P144TSLMU-A1		
Indoor Model			Non-Ducted	Ducted	
Power source			3-phase 3-wire 208-230 V ±10% 60 Hz		
Cooling capacity (Nominal)	(208-230)	*1 BTU/h	144,000		
		kW	42.2		
	(Rated)	Power input	7.11		
		Current input	21.9-19.8		
	(208-230)	*2	BTU/h	137,000	
			kW	40.2	
(208-230)	*2	Power input	6.53	7.72	
		Current input	20.1-18.2	23.8-21.5	
Temp. range of cooling	Indoor	W.B.	59~75°F (15~24°C)		
	Inlet water	°F	50~113°F (10~45°C)		
Heating capacity (Nominal)	(208-230)	*2 BTU/h	160,000		
		kW	46.9		
	(Rated)	Power input	7.45		
		Current input	22.9-20.7		
	(208-230)	*2	BTU/h	152,000	
			kW	44.5	
(208-230)	*2	Power input	6.86	7.22	
		Current input	21.1-19.1	22.2-20.1	
Temp. range of heating	Indoor	D.B.	59~81°F (15~27°C)		
	Inlet water	°F	50~113°F (10~45°C)		
Indoor unit connectable	Total capacity	50~150% of heat source unit capacity			
	Model/Quantity	P04~P96/1~36			
Sound pressure level (measured in anechoic room)			dB <A>		
Refrigerant piping diameter	High pressure	in. (mm)	7/8 (22.2) Brazed		
	Low pressure	in. (mm)	1-1/8 (28.58) Brazed		

Set Model			PQRY-P72TLMU-A1	PQRY-P72TLMU-A1
Minimum Circuit Ampacity			A	13-12
Maximum Overcurrent Protection			A	20-20
Circulating water	Water flow rate	G/h	1,522 + 1,522	
		G/min	25.4 + 25.4	
		m ³ /h	5.76 + 5.76	
		L/min	96 + 96	
		cfm	3.4 + 3.4	
	Pressure drop	psi	3.48	3.48
Operating volume range	kPa		24	24
		G/h	793 + 793 ~ 1,902 + 1,902	
		G/min	13.2 + 13.2 ~ 31.7 + 31.7	
		m ³ /h	3.0 + 3.0 ~ 7.2 + 7.2	
Compressor	Type x Quantity		Inverter scroll hermetic compressor x 1	
	Starting method		Inverter	
	Motor output	kW	4.3	4.3
	Case heater	kW	-	-
	Lubricant		MEL32	MEL32
External finish			Galvanized steel sheets	
External dimension H x W x D	in.		43-5/16 x 34-11/16 x 21-11/16	
		mm	1,100 x 880 x 550	
Protection devices	High pressure protection		High pressure sensor, High pressure switch at 4.15 MPa (601 psi)	
	Inverter circuit		Over-heat protection, Over-current protection	
	Compressor		Over-heat protection	
Refrigerant	Type x original charge		R410A x 11 lbs + 1 oz (5.0 kg)	
	Control		Indoor LEV and BC controller	
Net weight		lbs (kg)	382 (173)	382 (173)
Heat exchanger			plate type	
	Water volume in plate	G	1.32	1.32
		l	5.0	5.0
	Water pressure Max.	psi	290	290
MPa		2.0	2.0	
HIC circuit (HIC: Heat Inter-Changer)				
Pipe between unit and distributor	High pressure	in. (mm)	5/8 (15.88) Brazed	5/8 (15.88) Brazed
	Low pressure	in. (mm)	-	3/4 (19.05) Brazed
Drawing	External		KL94C219	
	Wiring		KE94G422	
Standard attachment	Document		Installation Manual	
	Accessory		Details refer to External Drw	
Optional parts			Heat Source Twinning kit: CMY-Q100CBK2 joint: CMY-Y102SS-G2, CMY-Y102LS-G2, CMY-R160-J1 Main BC controller: CMB-P108, 1012, 1016NU-JA1, CMB-P1016NU-KA1 Sub BC controller: CMB-P104, 108NU-KB1	
Remarks			<p>Details on foundation work, duct work, insulation work, electrical wiring, power source switch, and other items shall be referred to the Installation Manual.</p> <p>Due to continuing improvement, above specifications may be subject to change without notice.</p> <p>The ambient temperature of the Heat Source Unit needs to be kept below 104°F.D.B. (40°C.D.B.)</p> <p>The ambient relative humidity of the Heat Source Unit needs to be kept below 80%.</p> <p>The Heat Source Unit should not be installed at outdoor.</p> <p>Be sure to mount a strainer (more than 50 meshes) at the water inlet piping of the unit.</p> <p>Be sure to provide interlocking for the unit operation and water circuit.</p> <p>The Heat Source twinning kit (low pressure) should be connected to the low pressure side of the heat source unit.</p> <p>Install the supplied insulation material to the unused drain-socket.</p> <p>When installing insulation material around both water and refrigerant piping, follow the installation manual.</p> <p>The cooling tower and the water circuit must be a closed circuit (water is not exposed to the atmosphere).</p>	

Notes:	Unit converter
1.Nominal cooling conditions (Test conditions are based on AHRI 1230) Indoor: 81°F.D.B./66°F.W.B. (27°C.D.B./19°C.W.B.), Inlet water temperature: 86°F (30°C)	BTU/h =kW x 3.412
2.Nominal heating conditions (Test conditions are based on AHRI 1230) Indoor: 68°F.D.B. (20°C.D.B.), Inlet water temperature: 68°F (20°C)	cfm =m ³ /min x 35.31
	lbs =kg/0.4536
	*Above specification data is subject to rounding variation.

1. SPECIFICATIONS

Heat Source Model		PQR-Y-P168TSLMU-A1		
Indoor Model		Non-Ducted	Ducted	
Power source		3-phase 3-wire 208-230 V ±10% 60 Hz		
Cooling capacity (Nominal)	*1	BTU/h	168,000	
		kW	49.2	
	(208-230)	Power input	kW	9.33
		Current input	A	28.7-26.0
	(Rated)		BTU/h	161,000
			kW	47.2
(208-230)	Power input	kW	8.58	
	Current input	A	26.4-23.9	
Temp. range of cooling	Indoor	W.B.	59~75°F (15~24°C)	
	Inlet water	°F	50~113°F (10~45°C)	
Heating capacity (Nominal)	*2	BTU/h	188,000	
		kW	55.1	
	(208-230)	Power input	kW	9.34
		Current input	A	28.8-26.0
	(Rated)		BTU/h	179,000
			kW	52.5
(208-230)	Power input	kW	8.60	
	Current input	A	26.5-23.9	
Temp. range of heating	Indoor	D.B.	59~81°F (15~27°C)	
	Inlet water	°F	50~113°F (10~45°C)	
Indoor unit connectable	Total capacity	50~150% of heat source unit capacity		
	Model/Quantity	P04~P96/1~42		
Sound pressure level (measured in anechoic room)	dB <A>	50.0		
Refrigerant piping diameter	High pressure	in. (mm)	7/8 (22.2) Braze	
	Low pressure	in. (mm)	1-1/8 (28.58) Braze	

Set Model		PQR-Y-P96TLMU-A1		PQR-Y-P72TLMU-A1		
Model		PQR-Y-P96TLMU-A1		PQR-Y-P72TLMU-A1		
Minimum Circuit Ampacity		A		19-17		
Maximum Overcurrent Protection		A		30-25		
Circulating water	Water flow rate	G/h	1,522 + 1,522			
		G/min	25.4 + 25.4			
		m ³ /h	5.76 + 5.76			
		L/min	96 + 96			
		cfm	3.4 + 3.4			
	Pressure drop	psi	3.48			
	kPa	24				
Operating volume range		G/h	793 + 793 ~ 1,902 + 1,902			
		G/min	13.2 + 13.2 ~ 31.7 + 31.7			
		m ³ /h	3.0 + 3.0 ~ 7.2 + 7.2			
Compressor	Type x Quantity	Inverter scroll hermetic compressor x 1		Inverter scroll hermetic compressor x 1		
	Starting method	Inverter		Inverter		
	Motor output	kW	6.0		4.3	
	Case heater	kW	-		-	
	Lubricant		MEL32		MEL32	
External finish		Galvanized steel sheets		Galvanized steel sheets		
External dimension H x W x D	in.	43-5/16 x 34-11/16 x 21-11/16		43-5/16 x 34-11/16 x 21-11/16		
	mm	1,100 x 880 x 550		1,100 x 880 x 550		
Protection devices	High pressure protection	High pressure sensor, High pressure switch at 4.15 MPa (601 psi)		High pressure sensor, High pressure switch at 4.15 MPa (601 psi)		
	Inverter circuit	Over-heat protection, Over-current protection		Over-heat protection, Over-current protection		
	Compressor	Over-heat protection		Over-heat protection		
Refrigerant	Type x original charge	R410A x 11 lbs + 1 oz (5.0 kg)		R410A x 11 lbs + 1 oz (5.0 kg)		
	Control	Indoor LEV and BC controller				
Net weight	lbs (kg)	382 (173)		382 (173)		
Heat exchanger	Water volume in plate	plate type		plate type		
		G	1.32		1.32	
	l	5.0		5.0		
	Water pressure Max.	psi	290		290	
MPa		2.0		2.0		
HIC circuit (HIC: Heat Inter-Changer)						
Pipe between unit and distributor	High pressure	in. (mm)	3/4 (19.05) Braze		3/4 (19.05) Braze	
	Low pressure	in. (mm)	-		7/8 (22.2) Braze	
Drawing	External	KL94C219		KL94C219		
	Wiring	KE94G422		KE94G422		
Standard attachment	Document	Installation Manual				
	Accessory	Details refer to External Drw				
Optional parts	Heat Source Twinning kit: CMY-Q100CBK2 joint: CMY-Y102SS-G2, CMY-Y102LS-G2, CMY-R160-J1 Main BC controller: CMB-P108, 1012, 1016NU-JA1, CMB-P1016NU-KA1 Sub BC controller: CMB-P104, 108NU-KB1					
Remarks	Details on foundation work, duct work, insulation work, electrical wiring, power source switch, and other items shall be referred to the Installation Manual. Due to continuing improvement, above specifications may be subject to change without notice. The ambient temperature of the Heat Source Unit needs to be kept below 104°F.D.B. (40°C.D.B.) The ambient relative humidity of the Heat Source Unit needs to be kept below 80%. The Heat Source Unit should not be installed at outdoor. Be sure to mount a strainer (more than 50 meshes) at the water inlet piping of the unit. Be sure to provide interlocking for the unit operation and water circuit. The Heat Source twinning kit (low pressure) should be connected to the low pressure side of the heat source unit. Install the supplied insulation material to the unused drain-socket. When installing insulation material around both water and refrigerant piping, follow the installation manual. The cooling tower and the water circuit must be a closed circuit (water is not exposed to the atmosphere).					

Notes:	Unit converter
1.Nominal cooling conditions (Test conditions are based on AHRI 1230) Indoor: 81°F.D.B./66°F.W.B. (27°C.D.B./19°C.W.B.), Inlet water temperature: 86°F (30°C)	BTU/h =kW x 3,412
2.Nominal heating conditions (Test conditions are based on AHRI 1230) Indoor: 68°F.D.B. (20°C.D.B.), Inlet water temperature: 68°F (20°C)	cfm =m ³ /min x 35.31
	lbs =kg/0.4536
	*Above specification data is subject to rounding variation.

1. SPECIFICATIONS

PQRY-P-T(S)LMU-A1, Y(S)LMU-A1

Heat Source Model			PQRY-P192TSLMU-A1		
Indoor Model			Non-Ducted	Ducted	
Power source			3-phase 3-wire 208-230 V ±10% 60 Hz		
Cooling capacity (Nominal)	*1	BTU/h	192,000		
		kW	56.3		
	(208-230)	Power input	kW	11.30	
		Current input	A	34.8-31.5	
	(Rated)		BTU/h	183,000	
			kW	53.6	
(208-230)	Power input	kW	10.40	10.98	
	Current input	A	32.0-29.0	33.8-30.6	
Temp. range of cooling	Indoor	W.B.	59~75°F (15~24°C)		
	Inlet water	°F	50~113°F (10~45°C)		
Heating capacity (Nominal)	*2	BTU/h	215,000		
		kW	63.0		
	(208-230)	Power input	kW	11.02	
		Current input	A	33.9-30.7	
	(Rated)		BTU/h	205,000	
			kW	60.1	
(208-230)	Power input	kW	10.16	8.90	
	Current input	A	31.3-28.3	27.4-24.8	
Temp. range of heating	Indoor	D.B.	59~81°F (15~27°C)		
	Inlet water	°F	50~113°F (10~45°C)		
Indoor unit connectable	Total capacity	50~150% of heat source unit capacity			
	Model/Quantity	P04-P96/1-48			
Sound pressure level (measured in anechoic room)	dB <A>	51.0			
Refrigerant piping diameter	High pressure	in. (mm)	7/8 (22.2) Brazed		
	Low pressure	in. (mm)	1-1/8 (28.58) Brazed		

Set Model			PQRY-P96TLMU-A1	PQRY-P96TLMU-A1
Model			PQRY-P96TLMU-A1	PQRY-P96TLMU-A1
Minimum Circuit Ampacity			A	19-17
Maximum Overcurrent Protection			A	30-25
Circulating water	Water flow rate	G/h	1,522 + 1,522	
		G/min	25.4 + 25.4	
		m ³ /h	5.76 + 5.76	
		L/min	96 + 96	
		cfm	3.4 + 3.4	
	Pressure drop	psi	3.48	3.48
	kPa	24	24	
Operating volume range	G/h	793 + 793 ~ 1,902 + 1,902		
	G/min	13.2 + 13.2 ~ 31.7 + 31.7		
	m ³ /h	3.0 + 3.0 ~ 7.2 + 7.2		
Compressor	Type x Quantity	Inverter scroll hermetic compressor x 1		Inverter scroll hermetic compressor x 1
	Starting method	Inverter		Inverter
	Motor output	kW	6.0	6.0
	Case heater	kW	-	-
	Lubricant		MEL32	MEL32
External finish			Galvanized steel sheets	Galvanized steel sheets
External dimension H x W x D	in.	43-5/16 x 34-11/16 x 21-11/16		43-5/16 x 34-11/16 x 21-11/16
	mm	1,100 x 880 x 550		1,100 x 880 x 550
Protection devices	High pressure protection	High pressure sensor, High pressure switch at 4.15 MPa (601 psi)	High pressure sensor, High pressure switch at 4.15 MPa (601 psi)	
	Inverter circuit	Over-heat protection, Over-current protection		Over-heat protection, Over-current protection
	Compressor	Over-heat protection		Over-heat protection
Refrigerant	Type x original charge	R410A x 11 lbs + 1 oz (5.0 kg)		R410A x 11 lbs + 1 oz (5.0 kg)
	Control	Indoor LEV and BC controller		
Net weight	lbs (kg)	382 (173)		382 (173)
Heat exchanger	Water volume in plate	plate type	plate type	
		G	1.32	
	I	5.0		
	Water pressure Max.	psi	290	
MPa		2.0		
HIC circuit (HIC: Heat Inter-Changer)			-	-
Pipe between unit and distributor	High pressure	in. (mm)	3/4 (19.05) Brazed	
	Low pressure	in. (mm)	-	
Drawing	External	KL94C219		KL94C219
	Wiring	KE94G422		KE94G422
Standard attachment	Document	Installation Manual		
	Accessory	Details refer to External Drw		
Optional parts	Heat Source Twinning kit: CMY-Q100CBK2 joint: CMY-Y102SS-G2, CMY-Y102LS-G2, CMY-R160-J1 Main BC controller: CMB-P108, 1012, 1016NU-JA1, CMB-P1016NU-KA1 Sub BC controller: CMB-P104, 108NU-KB1			

Remarks

Details on foundation work, duct work, insulation work, electrical wiring, power source switch, and other items shall be referred to the Installation Manual.

Due to continuing improvement, above specifications may be subject to change without notice.

The ambient temperature of the Heat Source Unit needs to be kept below 104°F.D.B. (40°C.D.B.)

The ambient relative humidity of the Heat Source Unit needs to be kept below 80%.

The Heat Source Unit should not be installed at outdoor.

Be sure to mount a strainer (more than 50 meshes) at the water inlet piping of the unit.

Be sure to provide interlocking for the unit operation and water circuit.

The Heat Source twinning kit (low pressure) should be connected to the low pressure side of the heat source unit.

Install the supplied insulation material to the unused drain-socket.

When installing insulation material around both water and refrigerant piping, follow the installation manual.

The cooling tower and the water circuit must be a closed circuit (water is not exposed to the atmosphere).

Notes:	Unit converter
1.Nominal cooling conditions (Test conditions are based on AHRI 1230) Indoor: 81°F.D.B./66°F.W.B. (27°C.D.B./19°C.W.B.), Inlet water temperature: 86°F (30°C)	BTU/h =kW x 3,412
2.Nominal heating conditions (Test conditions are based on AHRI 1230) Indoor: 68°F.D.B. (20°C.D.B.), Inlet water temperature: 68°F (20°C)	cfm =m ³ /min x 35.31
	lbs =kg/0.4536
	*Above specification data is subject to rounding variation.

1. SPECIFICATIONS

PQRY-P-T(S)LMU-A1, Y(S)LMU-A1

Heat Source Model		PQRY-P216TSLMU-A1		
Indoor Model		Non-Ducted	Ducted	
Power source		3-phase 3-wire 208-230 V ±10% 60 Hz		
Cooling capacity (Nominal)	*1	BTU/h	216,000	
		kW	63.3	
	(208-230)	Power input	14.03	
		Current input	43.2-39.1	
	(Rated)		BTU/h	206,000
			kW	60.4
(208-230)	Power input	12.93	13.24	
	Current input	39.8-36.0	40.8-36.9	
Temp. range of cooling	Indoor	W.B.	59~75°F (15~24°C)	
	Inlet water	°F	50~113°F (10~45°C)	
Heating capacity (Nominal)	*2	BTU/h	243,000	
		kW	71.2	
	(208-230)	Power input	12.88	
		Current input	39.7-35.9	
	(Rated)		BTU/h	232,000
			kW	68.0
(208-230)	Power input	11.88	10.35	
	Current input	36.6-33.1	31.9-28.8	
Temp. range of heating	Indoor	D.B.	59~81°F (15~27°C)	
	Inlet water	°F	50~113°F (10~45°C)	
Indoor unit connectable	Total capacity	50~150% of heat source unit capacity		
	Model/Quantity	P04~P96/2~50 (Connectable branch pipe number is max. 48.)		
Sound pressure level (measured in anechoic room)	dB <A>	55.0		
Refrigerant piping diameter	High pressure	7/8 (22.2) Brazed (1-1/8 (28.58) Brazed for the part that exceeds 65 m)		
	Low pressure	1-1/8 (28.58) Brazed		

Set Model		PQRY-P120TLMU-A1		PQRY-P96TLMU-A1	
Minimum Circuit Ampacity		A	29-26	19-17	
Maximum Overcurrent Protection		A	50-45	30-25	
Circulating water	Water flow rate	G/h	1,522 + 1,522		
		G/min	25.4 + 25.4		
		m ³ /h	5.76 + 5.76		
		L/min	96 + 96		
		cfm	3.4 + 3.4		
	Pressure drop	psi	3.48	3.48	
	kPa	24	24		
Operating volume range		G/h	793 + 793 ~ 1,902 + 1,902		
		G/min	13.2 + 13.2 ~ 31.7 + 31.7		
		m ³ /h	3.0 + 3.0 ~ 7.2 + 7.2		
Compressor	Type x Quantity	Inverter scroll hermetic compressor x 1		Inverter scroll hermetic compressor x 1	
	Starting method	Inverter		Inverter	
	Motor output	kW	7.7	6.0	
	Case heater	kW	-	-	
	Lubricant		MEL32	MEL32	
External finish		Galvanized steel sheets		Galvanized steel sheets	
External dimension H x W x D	in.	43-5/16 x 34-11/16 x 21-11/16		43-5/16 x 34-11/16 x 21-11/16	
	mm	1,100 x 880 x 550		1,100 x 880 x 550	
Protection devices	High pressure protection	High pressure sensor, High pressure switch at 4.15 MPa (601 psi)		High pressure sensor, High pressure switch at 4.15 MPa (601 psi)	
	Inverter circuit	Over-heat protection, Over-current protection		Over-heat protection, Over-current protection	
	Compressor	Over-heat protection		Over-heat protection	
Refrigerant	Type x original charge	R410A x 11 lbs + 1 oz (5.0 kg)		R410A x 11 lbs + 1 oz (5.0 kg)	
	Control	Indoor LEV and BC controller			
Net weight	lbs (kg)	382 (173)		382 (173)	
Heat exchanger	Water volume in plate	plate type	plate type		
		G	1.32		
	l	5.0			
	Water pressure Max.	psi	290		
MPa		2.0			
HIC circuit (HIC: Heat Inter-Changer)		-		-	
Pipe between unit and distributor	High pressure	in. (mm)	3/4 (19.05) Brazed		
	Low pressure	in. (mm)	-		
Drawing	External	KL94C219			
	Wiring	KE94G422	KE94G422		
Standard attachment	Document	Installation Manual			
	Accessory	Details refer to External Drw			
Optional parts	Heat Source Twinning kit: CMY-Q100CBK2 joint: CMY-Y102SS-G2, CMY-Y102LS-G2, CMY-R160-J1 Main BC controller: CMB-P108, 1012, 1016NU-JA1, CMB-P1016NU-KA1 Sub BC controller: CMB-P104, 108NU-KB1				
Remarks	Details on foundation work, duct work, insulation work, electrical wiring, power source switch, and other items shall be referred to the Installation Manual. Due to continuing improvement, above specifications may be subject to change without notice. The ambient temperature of the Heat Source Unit needs to be kept below 104°F.D.B. (40°C.D.B.) The ambient relative humidity of the Heat Source Unit needs to be kept below 80%. The Heat Source Unit should not be installed at outdoor. Be sure to mount a strainer (more than 50 meshes) at the water inlet piping of the unit. Be sure to provide interlocking for the unit operation and water circuit. The Heat Source twinning kit (low pressure) should be connected to the low pressure side of the heat source unit. Install the supplied insulation material to the unused drain-socket. When installing insulation material around both water and refrigerant piping, follow the installation manual. When the high pressure piping length is 65 m or less, use 7/8 (22.2) pipe. When the high pressure piping length exceeds 65 m, use 1-1/8 (28.58) pipe until 65 m, use 1-1/8 (28.58) pipe for the part that exceeds 65 m. The cooling tower and the water circuit must be a closed circuit (water is not exposed to the atmosphere).				

Notes:	Unit converter
1. Nominal cooling conditions (Test conditions are based on AHRI 1230) Indoor: 81°F.D.B./66°F.W.B. (27°C.D.B./19°C.W.B.), Inlet water temperature: 86°F (30°C)	BTU/h =kW x 3,412
2. Nominal heating conditions (Test conditions are based on AHRI 1230) Indoor: 68°F.D.B. (20°C.D.B.), Inlet water temperature: 68°F (20°C)	cfm =m ³ /min x 35.31
	lbs =kg/0.4536
	*Above specification data is subject to rounding variation.

1. SPECIFICATIONS

WR2-Series

PQRY-P-T(S)LMU-A1, Y(S)LMU-A1

Heat Source Model			PQRY-P240TSLMU-A1		
Indoor Model			Non-Ducted	Ducted	
Power source			3-phase 3-wire 208-230 V ±10% 60 Hz		
Cooling capacity (Nominal)	*1	BTU/h	240,000		
		kW	70.3		
	(208-230)	Power input	kW	16.89	
		Current input	A	52.0-47.1	
	(Rated)	BTU/h	228,000		
		kW	66.8		
	(208-230)	Power input	kW	15.57	16.15
		Current input	A	48.0-43.4	49.8-45.0
Temp. range of cooling	Indoor	W.B.	59~75°F (15~24°C)		
	Inlet water	°F	50~113°F (10~45°C)		
Heating capacity (Nominal)	*2	BTU/h	270,000		
		kW	79.1		
	(208-230)	Power input	kW	14.58	
		Current input	A	44.9-40.6	
	(Rated)	BTU/h	258,000		
		kW	75.6		
	(208-230)	Power input	kW	13.45	12.02
		Current input	A	41.4-37.5	37.0-33.5
Temp. range of heating	Indoor	D.B.	59~81°F (15~27°C)		
	Inlet water	°F	50~113°F (10~45°C)		
Indoor unit connectable	Total capacity	50~150% of heat source unit capacity			
Indoor unit connectable	Model/Quantity	P04~P96/2~50 (Connectable branch pipe number is max. 48.)			
Sound pressure level (measured in anechoic room)	dB <A>	57.0			
Refrigerant piping diameter	High pressure	in. (mm)	7/8 (22.2) Brazed (1-1/8 (28.58) Brazed for the part that exceeds 65 m)		
	Low pressure	in. (mm)	1-3/8 (34.93) Brazed		

Set Model			PQRY-P120TLMU-A1		
Model			PQRY-P120TLMU-A1	PQRY-P120TLMU-A1	
Minimum Circuit Ampacity			A	29-26	
Maximum Overcurrent Protection			A	50-45	
Circulating water	Water flow rate	G/h	1,522 + 1,522		
		G/min	25.4 + 25.4		
		m ³ /h	5.76 + 5.76		
		L/min	96 + 96		
		cfm	3.4 + 3.4		
	Pressure drop	psi	3.48	3.48	
		kPa	24	24	
Operating volume range	G/h	793 + 793 ~ 1,902 + 1,902			
	G/min	13.2 + 13.2 ~ 31.7 + 31.7			
	m ³ /h	3.0 + 3.0 ~ 7.2 + 7.2			
Compressor	Type x Quantity	Inverter scroll hermetic compressor x 1		Inverter scroll hermetic compressor x 1	
	Starting method	Inverter		Inverter	
	Motor output	kW	7.7	7.7	
	Case heater	kW	-	-	
	Lubricant	MEL32		MEL32	
External finish			Galvanized steel sheets		
External dimension H x W x D	in.	43-5/16 x 34-11/16 x 21-11/16		43-5/16 x 34-11/16 x 21-11/16	
	mm	1,100 x 880 x 550		1,100 x 880 x 550	
Protection devices	High pressure protection	High pressure sensor, High pressure switch at 4.15 MPa (601 psi)		High pressure sensor, High pressure switch at 4.15 MPa (601 psi)	
	Inverter circuit	Over-heat protection, Over-current protection		Over-heat protection, Over-current protection	
	Compressor	Over-heat protection		Over-heat protection	
Refrigerant	Type x original charge	R410A x 11 lbs + 1 oz (5.0 kg)		R410A x 11 lbs + 1 oz (5.0 kg)	
	Control	Indoor LEV and BC controller			
Net weight	lbs (kg)	382 (173)		382 (173)	
Heat exchanger	Water volume in plate	plate type	plate type		
		G	1.32	1.32	
	l	5.0	5.0		
	Water pressure Max.	psi	290	290	
MPa		2.0	2.0		
HIC circuit (HIC: Heat Inter-Changer)			-		
Pipe between unit and distributor	High pressure	in. (mm)	3/4 (19.05) Brazed		
	Low pressure	in. (mm)	-		
Drawing	External	KL94C219			
	Wiring	KE94G422	KE94G422		
Standard attachment	Document	Installation Manual			
	Accessory	Details refer to External Drw			
Optional parts	Heat Source Twinning kit: CMY-Q100CBK2 joint: CMY-Y102SS-G2, CMY-Y102LS-G2, CMY-R160-J1 Main BC controller: CMB-P108, 1012, 1016NU-JA1, CMB-P1016NU-KA1 Sub BC controller: CMB-P104, 108NU-KB1				
Remarks	<p>Details on foundation work, duct work, insulation work, electrical wiring, power source switch, and other items shall be referred to the Installation Manual.</p> <p>Due to continuing improvement, above specifications may be subject to change without notice.</p> <p>The ambient temperature of the Heat Source Unit needs to be kept below 104°F D.B. (40°C D.B.)</p> <p>The ambient relative humidity of the Heat Source Unit needs to be kept below 80%.</p> <p>The Heat Source Unit should not be installed at outdoor.</p> <p>Be sure to mount a strainer (more than 50 meshes) at the water inlet piping of the unit.</p> <p>Be sure to provide interlocking for the unit operation and water circuit.</p> <p>The Heat Source twinning kit (low pressure) should be connected to the low pressure side of the heat source unit.</p> <p>Install the supplied insulation material to the unused drain-socket.</p> <p>When installing insulation material around both water and refrigerant piping, follow the installation manual.</p> <p>When the high pressure piping length is 65 m or less, use 7/8 (22.2) pipe. When the high pressure piping length exceeds 65 m, use 1-1/8 (28.58) pipe until 65 m, use 1-1/8 (28.58) pipe for the part that exceeds 65 m.</p> <p>The cooling tower and the water circuit must be a closed circuit (water is not exposed to the atmosphere).</p>				

Notes:	Unit converter
1. Nominal cooling conditions (Test conditions are based on AHRI 1230) Indoor: 81°F D.B./66°F W.B. (27°C D.B./19°C W.B.), Inlet water temperature: 86°F (30°C)	BTU/h = kW x 3.412
2. Nominal heating conditions (Test conditions are based on AHRI 1230) Indoor: 68°F D.B. (20°C D.B.), Inlet water temperature: 68°F (20°C)	cfm = m ³ /min x 35.31
	lbs = kg/0.4536
	*Above specification data is subject to rounding variation.

1. SPECIFICATIONS

Heat Source Model		PQRY-P288TSLMU-A1		
Indoor Model		Non-Ducted	Ducted	
Power source		3-phase 3-wire 208-230 V ±10% 60 Hz		
Cooling capacity (Nominal)	*1	BTU/h	288,000	
		kW	84.4	
	(208-230)	Power input	kW	20.42
		Current input	A	62.9-56.9
	(Rated)		BTU/h	275,000
			kW	80.6
(208-230)	Power input	kW	18.82	
	Current input	A	58.0-52.4	
Temp. range of cooling	Indoor	W.B.	59~75°F (15~24°C)	
	Inlet water	°F	50~113°F (10~45°C)	
Heating capacity (Nominal)	*2	BTU/h	323,000	
		kW	94.7	
	(208-230)	Power input	kW	17.50
		Current input	A	53.9-48.8
	(Rated)		BTU/h	308,000
			kW	90.3
(208-230)	Power input	kW	16.13	
	Current input	A	49.7-44.9	
Temp. range of heating	Indoor	D.B.	59~81°F (15~27°C)	
	Inlet water	°F	50~113°F (10~45°C)	
Indoor unit connectable	Total capacity	50~150% of heat source unit capacity		
	Model/Quantity	P04~P96/2~50 (Connectable branch pipe number is max. 48.)		
Sound pressure level (measured in anechoic room)	dB <A>	57.0		
Refrigerant piping diameter	High pressure	in. (mm)	1-1/8 (28.58) Braze	
	Low pressure	in. (mm)	1-3/8 (34.93) Braze	

Set Model		PQRY-P144TLMU-A1		PQRY-P144TLMU-A1	
Minimum Circuit Ampacity		A	35-32	35-32	
Maximum Overcurrent Protection		A	60-50	60-50	
Circulating water	Water flow rate	G/h	1,902 + 1,902		
		G/min	31.7 + 31.7		
		m ³ /h	7.20 + 7.20		
		L/min	120 + 120		
		cfm	4.2 + 4.2		
	Pressure drop	psi	6.38	6.38	
	kPa	44	44		
Operating volume range	G/h	1,189 + 1,189 ~ 3,054 + 3,054			
	G/min	19.8 + 19.8 ~ 50.9 + 50.9			
	m ³ /h	4.5 + 4.5 ~ 11.6 + 11.6			
Compressor	Type x Quantity	Inverter scroll hermetic compressor x 1		Inverter scroll hermetic compressor x 1	
	Starting method	Inverter		Inverter	
	Motor output	kW	9.5	9.5	
	Case heater	kW	-	-	
	Lubricant		MEL32	MEL32	
External finish		Galvanized steel sheets		Galvanized steel sheets	
External dimension H x W x D	in.	57-1/8 x 34-11/16 x 21-11/16		57-1/8 x 34-11/16 x 21-11/16	
	mm	1,450 x 880 x 550		1,450 x 880 x 550	
Protection devices	High pressure protection	High pressure sensor, High pressure switch at 4.15 MPa (601 psi)		High pressure sensor, High pressure switch at 4.15 MPa (601 psi)	
	Inverter circuit	Over-heat protection, Over-current protection		Over-heat protection, Over-current protection	
	Compressor	Over-heat protection		Over-heat protection	
Refrigerant	Type x original charge	R410A x 13 lbs + 4 oz (6.0 kg)		R410A x 13 lbs + 4 oz (6.0 kg)	
	Control	Indoor LEV and BC controller			
Net weight	lbs (kg)	481 (218)		481 (218)	
Heat exchanger	Water volume in plate	plate type			plate type
		G	1.32		1.32
	l	5.0		5.0	
	Water pressure Max.	psi	290		290
MPa		2.0		2.0	
HIC circuit (HIC: Heat Inter-Changer)		-		-	
Pipe between unit and distributor	High pressure	in. (mm)	7/8 (22.2) Braze		7/8 (22.2) Braze
	Low pressure	in. (mm)	-		1-1/8 (28.58) Braze
Drawing	External	KL94C220		KL94C220	
	Wiring	KE94G423		KE94G423	
Standard attachment	Document	Installation Manual			
	Accessory	Details refer to External Drw			
Optional parts	Heat Source Twinning kit: CMY-Q200CBK joint: CMY-Y102SS-G2, CMY-Y102LS-G2, CMY-R160-J1 Main BC controller: CMB-P108, 1012, 1016NU-JA1, CMB-P1016NU-KA1 Sub BC controller: CMB-P104, 108NU-KB1				
Remarks	Details on foundation work, duct work, insulation work, electrical wiring, power source switch, and other items shall be referred to the Installation Manual. Due to continuing improvement, above specifications may be subject to change without notice. The ambient temperature of the Heat Source Unit needs to be kept below 104°F D.B. (40°C D.B.) The ambient relative humidity of the Heat Source Unit needs to be kept below 80%. The Heat Source Unit should not be installed at outdoor. Be sure to mount a strainer (more than 50 meshes) at the water inlet piping of the unit. Be sure to provide interlocking for the unit operation and water circuit. The Heat Source twinning kit (low pressure) should be connected to the low pressure side of the heat source unit. Install the supplied insulation material to the unused drain-socket. When installing insulation material around both water and refrigerant piping, follow the installation manual. The cooling tower and the water circuit must be a closed circuit (water is not exposed to the atmosphere).				

Notes:	Unit converter
1. Nominal cooling conditions (Test conditions are based on AHRI 1230) Indoor: 81°F D.B./66°F W.B. (27°C D.B./19°C W.B.), Inlet water temperature: 86°F (30°C)	BTU/h = kW x 3,412
2. Nominal heating conditions (Test conditions are based on AHRI 1230) Indoor: 68°F D.B. (20°C D.B.), Inlet water temperature: 68°F (20°C)	cfm = m ³ /min x 35.31
	lbs = kg/0.4536
	*Above specification data is subject to rounding variation.

1. SPECIFICATIONS

WR2-Series

PQRY-P-T(S)LMU-A1, Y(S)LMU-A1

Heat Source Model			PQRY-P312TSLMU-A1	
Indoor Model			Non-Ducted	Ducted
Power source			3-phase 3-wire 208-230 V ±10% 60 Hz	
Cooling capacity (Nominal)	*1	BTU/h	312,000	
		kW	91.4	
	(208-230)	Power input	23.41	
		Current input	72.1-65.2	
	(Rated)	BTU/h	297,000	
		kW	87.0	
(208-230)	Power input	21.59	23.67	
	Current input	66.5-60.2	73.0-66.0	
Temp. range of cooling	Indoor	W.B.	59~75°F (15~24°C)	
	Inlet water	°F	50~113°F (10~45°C)	
Heating capacity (Nominal)	*2	BTU/h	350,000	
		kW	102.6	
	(208-230)	Power input	19.11	
		Current input	58.9-53.3	
	(Rated)	BTU/h	334,000	
		kW	97.9	
(208-230)	Power input	17.62	17.96	
	Current input	54.3-49.1	55.3-50.0	
Temp. range of heating	Indoor	D.B.	59~81°F (15~27°C)	
	Inlet water	°F	50~113°F (10~45°C)	
Indoor unit connectable	Total capacity	50~150% of heat source unit capacity		
	Model/Quantity	P04~P96/2~50 (Connectable branch pipe number is max. 48.)		
Sound pressure level (measured in anechoic room)	dB <A>	58.0		
Refrigerant piping diameter	High pressure	in. (mm)	1-1/8 (28.58) Brazed	
	Low pressure	in. (mm)	1-3/8 (34.93) Brazed	

Set Model			PQRY-P168TLMU-A1		PQRY-P144TLMU-A1	
Minimum Circuit Ampacity			A		44-39	
Maximum Overcurrent Protection			A		70-70	
Circulating water	Water flow rate	G/h	1,902 + 1,902			
		G/min	31.7 + 31.7			
		m ³ /h	7.20 + 7.20			
		L/min	120 + 120			
		cfm	4.2 + 4.2			
	Pressure drop	psi	6.38		6.38	
	kPa	44		44		
Operating volume range	G/h	1,189 + 1,189 ~ 3,054 + 3,054				
	G/min	19.8 + 19.8 ~ 50.9 + 50.9				
	m ³ /h	4.5 + 4.5 ~ 11.6 + 11.6				
Compressor	Type x Quantity	Inverter scroll hermetic compressor x 1		Inverter scroll hermetic compressor x 1		
	Starting method	Inverter		Inverter		
	Motor output	kW	11.0		9.5	
	Case heater	kW	-		-	
	Lubricant		MEL32		MEL32	
External finish			Galvanized steel sheets		Galvanized steel sheets	
External dimension H x W x D	in.	57-1/8 x 34-11/16 x 21-11/16		57-1/8 x 34-11/16 x 21-11/16		
		mm		1,450 x 880 x 550		
Protection devices	High pressure protection	High pressure sensor, High pressure switch at 4.15 MPa (601 psi)		High pressure sensor, High pressure switch at 4.15 MPa (601 psi)		
	Inverter circuit	Over-heat protection, Over-current protection		Over-heat protection, Over-current protection		
	Compressor	Over-heat protection		Over-heat protection		
Refrigerant	Type x original charge	R410A x 13 lbs + 4 oz (6.0 kg)		R410A x 13 lbs + 4 oz (6.0 kg)		
	Control	Indoor LEV and BC controller				
Net weight	lbs (kg)	481 (218)		481 (218)		
Heat exchanger	Water volume in plate	G	1.32		1.32	
		l	5.0		5.0	
	Water pressure Max.	psi	290		290	
		MPa	2.0		2.0	
HIC circuit (HIC: Heat Inter-Changer)			-		-	
Pipe between unit and distributor	High pressure	in. (mm)	7/8 (22.2) Brazed		7/8 (22.2) Brazed	
	Low pressure	in. (mm)	-		1-1/8 (28.58) Brazed	
Drawing	External	KL94C220				
	Wiring	KE94G423		KE94G423		
Standard attachment	Document	Installation Manual				
	Accessory	Details refer to External Drw				
Optional parts		Heat Source Twinning kit: CMY-Q200CBK joint: CMY-Y102SS-G2, CMY-Y102LS-G2, CMY-R160-J1 Main BC controller: CMB-P108, 1012, 1016NU-JA1, CMB-P1016NU-KA1 Sub BC controller: CMB-P104, 108NU-KB1				
Remarks		<p>Details on foundation work, duct work, insulation work, electrical wiring, power source switch, and other items shall be referred to the Installation Manual.</p> <p>Due to continuing improvement, above specifications may be subject to change without notice.</p> <p>The ambient temperature of the Heat Source Unit needs to be kept below 104°F.D.B. (40°C.D.B.)</p> <p>The ambient relative humidity of the Heat Source Unit needs to be kept below 80%.</p> <p>The Heat Source Unit should not be installed at outdoor.</p> <p>Be sure to mount a strainer (more than 50 meshes) at the water inlet piping of the unit.</p> <p>Be sure to provide interlocking for the unit operation and water circuit.</p> <p>The Heat Source twinning kit (low pressure) should be connected to the low pressure side of the heat source unit.</p> <p>Install the supplied insulation material to the unused drain-socket.</p> <p>When installing insulation material around both water and refrigerant piping, follow the installation manual.</p> <p>The cooling tower and the water circuit must be a closed circuit (water is not exposed to the atmosphere).</p>				

Notes:	Unit converter
1.Nominal cooling conditions (Test conditions are based on AHRI 1230) Indoor: 81°F.D.B./66°F.W.B. (27°C.D.B./19°C.W.B.), Inlet water temperature: 86°F (30°C)	BTU/h =kW x 3,412
2.Nominal heating conditions (Test conditions are based on AHRI 1230) Indoor: 68°F.D.B. (20°C.D.B.), Inlet water temperature: 68°F (20°C)	cfm =m ³ /min x 35.31
	lbs =kg/0.4536
	*Above specification data is subject to rounding variation.

1. SPECIFICATIONS

Heat Source Model		PQR-Y-P336TSLMU-A1		
Indoor Model		Non-Ducted	Ducted	
Power source		3-phase 3-wire 208-230 V ±10% 60 Hz		
Cooling capacity (Nominal)	*1	BTU/h	336,000	
		kW	98.5	
	(208-230)	Power input	kW	26.84
		Current input	A	82.7-74.8
	(Rated)		BTU/h	320,000
			kW	93.8
(208-230)	Power input	kW	24.76	
	Current input	A	76.3-69.0	
Temp. range of cooling	Indoor	W.B.	59~75°F (15~24°C)	
	Inlet water	°F	50~113°F (10~45°C)	
Heating capacity (Nominal)	*2	BTU/h	378,000	
		kW	110.8	
	(208-230)	Power input	kW	20.77
		Current input	A	64.0-57.9
	(Rated)		BTU/h	361,000
			kW	105.8
(208-230)	Power input	kW	19.16	
	Current input	A	59.0-53.4	
Temp. range of heating	Indoor	D.B.	59~81°F (15~27°C)	
	Inlet water	°F	50~113°F (10~45°C)	
Indoor unit connectable	Total capacity	50~150% of heat source unit capacity		
	Model/Quantity	P04~P96/2~50 (Connectable branch pipe number is max. 48.)		
Sound pressure level (measured in anechoic room)	dB <A>	59.0		
Refrigerant piping diameter	High pressure	in. (mm)	1-1/8 (28.58) Braze	
	Low pressure	in. (mm)	1-5/8 (41.28) Braze	

Set Model		PQR-Y-P168TLMU-A1	
Model		PQR-Y-P168TLMU-A1	PQR-Y-P168TLMU-A1
Minimum Circuit Ampacity	A	44-39	44-39
Maximum Overcurrent Protection	A	70-70	70-70
Circulating water	Water flow rate	G/h	1,902 + 1,902
		G/min	31.7 + 31.7
		m ³ /h	7.20 + 7.20
		L/min	120 + 120
		cfm	4.2 + 4.2
	Pressure drop	psi	6.38
	kPa	44	
Operating volume range	G/h	1,189 + 1,189 ~ 3,054 + 3,054	
	G/min	19.8 + 19.8 ~ 50.9 + 50.9	
	m ³ /h	4.5 + 4.5 ~ 11.6 + 11.6	
Compressor	Type x Quantity	Inverter scroll hermetic compressor x 1	
	Starting method	Inverter	
	Motor output	kW	
	Case heater	kW	
	Lubricant	MEL32	
External finish		Galvanized steel sheets	
External dimension H x W x D	in.	57-1/8 x 34-11/16 x 21-11/16	
	mm	1,450 x 880 x 550	
Protection devices	High pressure protection	High pressure sensor, High pressure switch at 4.15 MPa (601 psi)	
	Inverter circuit	Over-heat protection, Over-current protection	
	Compressor	Over-heat protection	
Refrigerant	Type x original charge	R410A x 13 lbs + 4 oz (6.0 kg)	
	Control	Indoor LEV and BC controller	
Net weight	lbs (kg)	481 (218)	
Heat exchanger	Water volume in plate	plate type	plate type
		G	1.32
	l	5.0	
	Water pressure Max.	psi	290
MPa		2.0	
HIC circuit (HIC: Heat Inter-Changer)		-	
Pipe between unit and distributor	High pressure	in. (mm)	7/8 (22.2) Braze
	Low pressure	in. (mm)	-
Drawing	External	KL94C220	
	Wiring	KE94G423	KE94G423
Standard attachment	Document	Installation Manual	
	Accessory	Details refer to External Drw	
Optional parts		Heat Source Twinning kit: CMY-Q200CBK joint: CMY-Y102SS-G2, CMY-Y102LS-G2, CMY-R160-J1 Main BC controller: CMB-P108, 1012, 1016NU-JA1, CMB-P1016NU-KA1 Sub BC controller: CMB-P104, 108NU-KB1	
Remarks		Details on foundation work, duct work, insulation work, electrical wiring, power source switch, and other items shall be referred to the Installation Manual. Due to continuing improvement, above specifications may be subject to change without notice. The ambient temperature of the Heat Source Unit needs to be kept below 104°F (40°C). The ambient relative humidity of the Heat Source Unit needs to be kept below 80%. The Heat Source Unit should not be installed at outdoor. Be sure to mount a strainer (more than 50 meshes) at the water inlet piping of the unit. Be sure to provide interlocking for the unit operation and water circuit. The Heat Source twinning kit (low pressure) should be connected to the low pressure side of the heat source unit. Install the supplied insulation material to the unused drain-socket. When installing insulation material around both water and refrigerant piping, follow the installation manual. The cooling tower and the water circuit must be a closed circuit (water is not exposed to the atmosphere).	

Notes:	Unit converter
1. Nominal cooling conditions (Test conditions are based on AHRI 1230) Indoor: 81°F D.B./66°F W.B. (27°C D.B./19°C W.B.), Inlet water temperature: 86°F (30°C)	BTU/h = kW x 3,412
2. Nominal heating conditions (Test conditions are based on AHRI 1230) Indoor: 68°F D.B. (20°C D.B.), Inlet water temperature: 68°F (20°C)	cfm = m ³ /min x 35.31
	lbs = kg/0.4536
	*Above specification data is subject to rounding variation.

1. SPECIFICATIONS

WR2-Series

PQRY-P-T(S)LMU-A1, Y(S)LMU-A1

Heat Source Model		PQRY-P72YLMU-A1			
Indoor Model		Non-Ducted	Ducted		
Power source		3-phase 3-wire 460 V ±10% 60 Hz			
Cooling capacity (Nominal)	*1	BTU/h	72,000		
		kW	21.1		
		kW	3.61		
	(460)	Current input	A	5.0	
	(Rated)		BTU/h	69,000	
			kW	20.2	
	(460)	Power input	kW	3.34	3.12
		Current input	A	4.6	4.3
	Temp. range of cooling	Indoor	W.B.	59~75°F (15~24°C)	
		Inlet water	°F	50~113°F (10~45°C)	
Heating capacity (Nominal)	*2	BTU/h	80,000		
		kW	23.4		
		kW	4.04		
	(460)	Current input	A		5.6
	(Rated)		BTU/h	76,000	
			kW	22.3	
	(460)	Power input	kW	3.74	3.36
		Current input	A	5.2	4.6
	Temp. range of heating	Indoor	D.B.	59~81°F (15~27°C)	
		Inlet water	°F	50~113°F (10~45°C)	
Indoor unit connectable	Total capacity	50~150% of heat source unit capacity			
	Model/Quantity	P04~P96/1~18			
Sound pressure level (measured in anechoic room)		dB <A>	46.0		
Refrigerant piping diameter	High pressure	in. (mm)	5/8 (15.88) Brazed		
	Low pressure	in. (mm)	3/4 (19.05) Brazed		
Minimum Circuit Ampacity		A	6		
Maximum Overcurrent Protection		A	15		
Circulating water	Water flow rate	G/h	1,522		
		G/min	25.4		
		m ³ /h	5.76		
		L/min	96		
		cfm	3.4		
	Pressure drop	psi	3.48		
		kPa	24		
	Operating volume range	G/h	793 ~ 1,902		
		G/min	13.2 ~ 31.7		
		m ³ /h	3.0 ~ 7.2		
Compressor	Type x Quantity		Inverter scroll hermetic compressor x 1		
	Starting method		Inverter		
	Motor output	kW	4.3		
	Case heater	kW	-		
	Lubricant		MEL32		
External finish		Galvanized steel sheets			
External dimension H x W x D		in.	43-5/16 x 34-11/16 x 21-11/16		
		mm	1,100 x 880 x 550		
Protection devices	High pressure protection		High pressure sensor, High pressure switch at 4.15 MPa (601 psi)		
	Inverter circuit		Over-heat protection, Over-current protection		
	Compressor		Over-heat protection		
Refrigerant	Type x original charge		R410A x 11 lbs + 1 oz (5.0 kg)		
	Control		Indoor LEV and BC controller		
Net weight		lbs (kg)	406 (184)		
Heat exchanger			plate type		
	Water volume in plate	G	1.32		
		l	5.0		
	Water pressure Max.	psi	290		
MPa		2.0			
HIC circuit (HIC: Heat Inter-Changer)		-			
Drawing	External		KL94C210		
	Wiring		KE94G419		
Standard attachment	Document		Installation Manual		
	Accessory		Details refer to External Drw		
Optional parts		joint: CMY-Y102SS-G2, CMY-Y102LS-G2, CMY-R160-J1 BC controller: CMB-P104, 106, 108, 1012, 1016NU-J1 Main BC controller: CMB-P108, 1012, 1016NU-JA1, CMB-P1016NU-KA1 Sub BC controller: CMB-P104, 108NU-KB1			
Remarks		Details on foundation work, duct work, insulation work, electrical wiring, power source switch, and other items shall be referred to the Installation Manual. Due to continuing improvement, above specifications may be subject to change without notice. The ambient temperature of the Heat Source Unit needs to be kept below 104°F.D.B. (40°C.D.B.) The ambient relative humidity of the Heat Source Unit needs to be kept below 80%. The Heat Source Unit should not be installed at outdoor. Be sure to mount a strainer (more than 50 meshes) at the water inlet piping of the unit. Be sure to provide interlocking for the unit operation and water circuit. Install the supplied insulation material to the unused drain-socket. When installing insulation material around both water and refrigerant piping, follow the installation manual. The cooling tower and the water circuit must be a closed circuit (water is not exposed to the atmosphere).			

Notes:		Unit converter
1.Nominal cooling conditions (Test conditions are based on AHRI 1230) Indoor: 81°F.D.B./66°F.W.B. (27°C.D.B./19°C.W.B.), Inlet water temperature: 86°F (30°C)		BTU/h =kW x 3,412
2.Nominal heating conditions (Test conditions are based on AHRI 1230) Indoor: 68°F.D.B. (20°C.D.B.), Inlet water temperature: 68°F (20°C)		cfm =m ³ /min x 35.31
		lbs =kg/0.4536
		*Above specification data is subject to rounding variation.

1. SPECIFICATIONS

Heat Source Model		PQRY-P96YLMU-A1		
Indoor Model		Non-Ducted	Ducted	
Power source		3-phase 3-wire 460 V ±10% 60 Hz		
Cooling capacity (Nominal)	*1	BTU/h	96,000	
		kW	28.1	
	(460)	Power input	kW	5.21
		Current input	A	7.2
	(Rated)		BTU/h	92,000
			kW	27.0
(460)	Power input	kW	4.82	
	Current input	A	6.7	
Temp. range of cooling	Indoor	W.B.	59~75°F (15~24°C)	
	Inlet water	°F	50~113°F (10~45°C)	
Heating capacity (Nominal)	*2	BTU/h	108,000	
		kW	31.7	
	(460)	Power input	kW	5.64
		Current input	A	7.8
	(Rated)		BTU/h	103,000
			kW	30.2
(460)	Power input	kW	5.21	
	Current input	A	7.2	
Temp. range of heating	Indoor	D.B.	59~81°F (15~27°C)	
	Inlet water	°F	50~113°F (10~45°C)	
Indoor unit connectable	Total capacity	50~150% of heat source unit capacity		
	Model/Quantity	P04-P96/1~24		
Sound pressure level (measured in anechoic room)	dB <A>	48.0		
Refrigerant piping diameter	High pressure	in. (mm)	3/4 (19.05) Brazed	
	Low pressure	in. (mm)	7/8 (22.2) Brazed	
Minimum Circuit Ampacity	A	9		
Maximum Overcurrent Protection	A	15		
Circulating water	Water flow rate	G/h	1,522	
		G/min	25.4	
		m ³ /h	5.76	
		L/min	96	
		cfm	3.4	
	Pressure drop	psi	3.48	
		kPa	24	
	Operating volume range	G/h	793 ~ 1,902	
G/min		13.2 ~ 31.7		
m ³ /h		3.0 ~ 7.2		
Compressor	Type x Quantity	Inverter scroll hermetic compressor x 1		
	Starting method	Inverter		
	Motor output	kW	6.0	
	Case heater	kW	-	
	Lubricant	MEL32		
External finish	Galvanized steel sheets			
External dimension H x W x D	in.	43-5/16 x 34-11/16 x 21-11/16		
	mm	1,100 x 880 x 550		
Protection devices	High pressure protection	High pressure sensor, High pressure switch at 4.15 MPa (601 psi)		
	Inverter circuit	Over-heat protection, Over-current protection		
	Compressor	Over-heat protection		
Refrigerant	Type x original charge	R410A x 11 lbs + 1 oz (5.0 kg)		
	Control	Indoor LEV and BC controller		
Net weight	lbs (kg)	406 (184)		
Heat exchanger	Water volume in plate	G	1.32	
		l	5.0	
	Water pressure Max.	psi	290	
		MPa	2.0	
HIC circuit (HIC: Heat Inter-Changer)	-			
Drawing	External	KL94C210		
	Wiring	KE94G419		
Standard attachment	Document	Installation Manual		
	Accessory	Details refer to External Drw		
Optional parts	joint: CMY-Y102SS-G2, CMY-Y102LS-G2, CMY-R160-J1 BC controller: CMB-P104, 106, 108, 1012, 1016NU-J1 Main BC controller: CMB-P108, 1012, 1016NU-JA1, CMB-P1016NU-KA1 Sub BC controller: CMB-P104, 108NU-KB1			
Remarks	Details on foundation work, duct work, insulation work, electrical wiring, power source switch, and other items shall be referred to the Installation Manual. Due to continuing improvement, above specifications may be subject to change without notice. The ambient temperature of the Heat Source Unit needs to be kept below 104°F.D.B. (40°C.D.B.) The ambient relative humidity of the Heat Source Unit needs to be kept below 80%. The Heat Source Unit should not be installed at outdoor. Be sure to mount a strainer (more than 50 meshes) at the water inlet piping of the unit. Be sure to provide interlocking for the unit operation and water circuit. Install the supplied insulation material to the unused drain-socket. When installing insulation material around both water and refrigerant piping, follow the installation manual. The cooling tower and the water circuit must be a closed circuit (water is not exposed to the atmosphere).			

Notes: 1.Nominal cooling conditions (Test conditions are based on AHRI 1230) Indoor: 81°F.D.B./66°F.W.B. (27°C.D.B./19°C.W.B.), Inlet water temperature: 86°F (30°C) 2.Nominal heating conditions (Test conditions are based on AHRI 1230) Indoor: 68°F.D.B. (20°C.D.B.), Inlet water temperature: 68°F (20°C)	Unit converter
	BTU/h =kW x 3,412
	cfm =m ³ /min x 35.31
	lbs =kg/0.4536
	*Above specification data is subject to rounding variation.

1. SPECIFICATIONS

PQRY-P-T(S)LMU-A1, Y(S)LMU-A1

Heat Source Model			PQRY-P120YLMU-A1	
Indoor Model			Non-Ducted	Ducted
Power source			3-phase 3-wire 460 V ±10% 60 Hz	
Cooling capacity (Nominal)	*1	BTU/h	120,000	
		kW	35.2	
	(460)	Power input	7.51	
		Current input	10.4	
	(Rated)	BTU/h	114,000	
		kW	33.4	
(460)	Power input	6.95	7.35	
	Current input	9.6	10.2	
Temp. range of cooling	Indoor	W.B.	59~75°F (15~24°C)	
	Inlet water	°F	50~113°F (10~45°C)	
Heating capacity (Nominal)	*2	BTU/h	135,000	
		kW	39.6	
	(460)	Power input	7.09	
		Current input	9.8	
	(Rated)	BTU/h	129,000	
		kW	37.8	
(460)	Power input	6.55	5.92	
	Current input	9.1	8.2	
Temp. range of heating	Indoor	D.B.	59~81°F (15~27°C)	
	Inlet water	°F	50~113°F (10~45°C)	
Indoor unit connectable	Total capacity	50~150% of heat source unit capacity		
	Model/Quantity	P04~P96/1~30		
Sound pressure level (measured in anechoic room)	dB <A>	54.0		
Refrigerant piping diameter	High pressure	in. (mm)	3/4 (19.05) Brazed	
	Low pressure	in. (mm)	7/8 (22.2) Brazed	
Minimum Circuit Ampacity	A	13		
Maximum Overcurrent Protection	A	20		
Circulating water	Water flow rate	G/h	1,522	
		G/min	25.4	
		m ³ /h	5.76	
		L/min	96	
		cfm	3.4	
	Pressure drop	psi	3.48	
		kPa	24	
Operating volume range	G/h	793 ~ 1,902		
	G/min	13.2 ~ 31.7		
	m ³ /h	3.0 ~ 7.2		
Compressor	Type x Quantity	Inverter scroll hermetic compressor x 1		
	Starting method	Inverter		
	Motor output	kW	7.7	
	Case heater	kW	-	
	Lubricant	MEL32		
External finish	Galvanized steel sheets			
External dimension H x W x D	in.	43-5/16 x 34-11/16 x 21-11/16		
	mm	1,100 x 880 x 550		
Protection devices	High pressure protection	High pressure sensor, High pressure switch at 4.15 MPa (601 psi)		
	Inverter circuit	Over-heat protection, Over-current protection		
	Compressor	Over-heat protection		
Refrigerant	Type x original charge	R410A x 11 lbs + 1 oz (5.0 kg)		
	Control	Indoor LEV and BC controller		
Net weight	lbs (kg)	406 (184)		
Heat exchanger	Water volume in plate	G	plate type	
		L	1.32	
	Water pressure Max.	psi	5.0	
		MPa	290	
HIC circuit (HIC: Heat Inter-Changer)		2.0		
Drawing	External	KL94C210		
	Wiring	KE94G419		
Standard attachment	Document	Installation Manual		
	Accessory	Details refer to External Drw		
Optional parts	joint: CMY-Y102SS-G2, CMY-Y102LS-G2, CMY-R160-J1 BC controller: CMB-P104, 106, 108, 1012, 1016NU-J1 Main BC controller: CMB-P108, 1012, 1016NU-JA1, CMB-P1016NU-KA1 Sub BC controller: CMB-P104, 108NU-KB1			
Remarks	Details on foundation work, duct work, insulation work, electrical wiring, power source switch, and other items shall be referred to the Installation Manual. Due to continuing improvement, above specifications may be subject to change without notice. The ambient temperature of the Heat Source Unit needs to be kept below 104°F.D.B. (40°C.D.B.) The ambient relative humidity of the Heat Source Unit needs to be kept below 80%. The Heat Source Unit should not be installed at outdoor. Be sure to mount a strainer (more than 50 meshes) at the water inlet piping of the unit. Be sure to provide interlocking for the unit operation and water circuit. Install the supplied insulation material to the unused drain-socket. When installing insulation material around both water and refrigerant piping, follow the installation manual. The cooling tower and the water circuit must be a closed circuit (water is not exposed to the atmosphere).			

Notes:	Unit converter
1.Nominal cooling conditions (Test conditions are based on AHRI 1230) Indoor: 81°F.D.B./66°F.W.B. (27°C.D.B./19°C.W.B.), Inlet water temperature: 86°F (30°C)	BTU/h =kW x 3,412
2.Nominal heating conditions (Test conditions are based on AHRI 1230) Indoor: 68°F.D.B. (20°C.D.B.), Inlet water temperature: 68°F (20°C)	cfm =m ³ /min x 35.31
	lbs =kg/0.4536
	*Above specification data is subject to rounding variation.

1. SPECIFICATIONS

Heat Source Model		PQR-Y-P144YLMU-A1		
Indoor Model		Non-Ducted	Ducted	
Power source		3-phase 3-wire 460 V ±10% 60 Hz		
Cooling capacity (Nominal)	*1	BTU/h	144,000	
		kW	42.2	
	(460)	Power input	kW	8.78
		Current input	A	12.2
	(Rated)		BTU/h	137,000
			kW	40.2
(460)	Power input	kW	8.07	
	Current input	A	11.2	
Temp. range of cooling	Indoor	W.B.	59~75°F (15~24°C)	
	Inlet water	°F	50~113°F (10~45°C)	
Heating capacity (Nominal)	*2	BTU/h	160,000	
		kW	46.9	
	(460)	Power input	kW	8.11
		Current input	A	11.3
	(Rated)		BTU/h	152,000
			kW	44.5
(460)	Power input	kW	7.47	
	Current input	A	10.4	
Temp. range of heating	Indoor	D.B.	59~81°F (15~27°C)	
	Inlet water	°F	50~113°F (10~45°C)	
Indoor unit connectable	Total capacity	50~150% of heat source unit capacity		
	Model/Quantity	P04~P96/1~36		
Sound pressure level (measured in anechoic room)		dB <A>	54.0	
Refrigerant piping diameter	High pressure	in. (mm)	7/8 (22.2) Brazed	
	Low pressure	in. (mm)	1-1/8 (28.58) Brazed	
Minimum Circuit Ampacity		A	16	
Maximum Overcurrent Protection		A	25	
Circulating water	Water flow rate	G/h	1,902	
		G/min	31.7	
		m ³ /h	7.20	
		L/min	120	
		cfm	4.2	
	Pressure drop	psi	6.38	
		kPa	44	
	Operating volume range	G/h	1,189 ~ 3,054	
G/min		19.8 ~ 50.9		
m ³ /h		4.5 ~ 11.6		
Compressor	Type x Quantity	Inverter scroll hermetic compressor x 1		
	Starting method	Inverter		
	Motor output	kW	9.5	
	Case heater	kW	-	
	Lubricant	MEL32		
External finish	Galvanized steel sheets			
External dimension H x W x D	in.	57-1/8 x 34-11/16 x 21-11/16		
	mm	1,450 x 880 x 550		
Protection devices	High pressure protection	High pressure sensor, High pressure switch at 4.15 MPa (601 psi)		
	Inverter circuit	Over-heat protection, Over-current protection		
	Compressor	Over-heat protection		
Refrigerant	Type x original charge	R410A x 13 lbs + 4 oz (6.0 kg)		
	Control	Indoor LEV and BC controller		
Net weight	lbs (kg)	508 (230)		
Heat exchanger	Water volume in plate	G	1.32	
		l	5.0	
	Water pressure Max.	psi	290	
		MPa	2.0	
HIC circuit (HIC: Heat Inter-Changer)	-			
Drawing	External	KL94C211		
	Wiring	KE94G419		
Standard attachment	Document	Installation Manual		
	Accessory	Details refer to External Drw		
Optional parts	joint: CMY-Y102SS-G2, CMY-Y102LS-G2, CMY-R160-J1 Main BC controller: CMB-P108, 1012, 1016NU-JA1, CMB-P1016NU-KA1 Sub BC controller: CMB-P104, 108NU-KB1			
Remarks	Details on foundation work, duct work, insulation work, electrical wiring, power source switch, and other items shall be referred to the Installation Manual. Due to continuing improvement, above specifications may be subject to change without notice. The ambient temperature of the Heat Source Unit needs to be kept below 104°F D.B. (40°C D.B.). The ambient relative humidity of the Heat Source Unit needs to be kept below 80%. The Heat Source Unit should not be installed at outdoor. Be sure to mount a strainer (more than 50 meshes) at the water inlet piping of the unit. Be sure to provide interlocking for the unit operation and water circuit. Install the supplied insulation material to the unused drain-socket. When installing insulation material around both water and refrigerant piping, follow the installation manual. The cooling tower and the water circuit must be a closed circuit (water is not exposed to the atmosphere).			

Notes:	Unit converter
1.Nominal cooling conditions (Test conditions are based on AHRI 1230) Indoor: 81°F D.B./66°F W.B. (27°C D.B./19°C W.B.), Inlet water temperature: 86°F (30°C)	BTU/h =kW x 3,412
2.Nominal heating conditions (Test conditions are based on AHRI 1230) Indoor: 68°F D.B. (20°C D.B.), Inlet water temperature: 68°F (20°C)	cfm =m ³ /min x 35.31
	lbs =kg/0.4536
	*Above specification data is subject to rounding variation.

1. SPECIFICATIONS

WR2-Series

PQRY-P-T(S)LMU-A1, Y(S)LMU-A1

Heat Source Model		PQRY-P168YLMU-A1		
Indoor Model		Non-Ducted	Ducted	
Power source		3-phase 3-wire 460 V ±10% 60 Hz		
Cooling capacity (Nominal)	*1	BTU/h	168,000	
		kW	49.2	
	(460)	Power input	kW	12.05
		Current input	A	16.8
	(Rated)		BTU/h	161,000
			kW	47.2
(460)	Power input	kW	11.10	
	Current input	A	15.4	
Temp. range of cooling	Indoor	W.B.	59~75°F (15~24°C)	
	Inlet water	°F	50~113°F (10~45°C)	
Heating capacity (Nominal)	*2	BTU/h	188,000	
		kW	55.1	
	(460)	Power input	kW	9.86
		Current input	A	13.7
	(Rated)		BTU/h	179,000
			kW	52.5
(460)	Power input	kW	9.09	
	Current input	A	12.6	
Temp. range of heating	Indoor	D.B.	59~81°F (15~27°C)	
	Inlet water	°F	50~113°F (10~45°C)	
Indoor unit connectable	Total capacity	50~150% of heat source unit capacity		
	Model/Quantity	P04-P96/1~42		
Sound pressure level (measured in anechoic room)	dB <A>	56.0		
Refrigerant piping diameter	High pressure	in. (mm)	7/8 (22.2) Brazed	
	Low pressure	in. (mm)	1-1/8 (28.58) Brazed	
Minimum Circuit Ampacity	A	20		
Maximum Overcurrent Protection	A	35		
Circulating water	Water flow rate	G/h	1,902	
		G/min	31.7	
		m ³ /h	7.20	
		L/min	120	
		cfm	4.2	
	Pressure drop	psi	6.38	
		kPa	44	
	Operating volume range	G/h	1,189 ~ 3,054	
G/min		19.8 ~ 50.9		
m ³ /h		4.5 ~ 11.6		
Compressor	Type x Quantity	Inverter scroll hermetic compressor x 1		
	Starting method	Inverter		
	Motor output	kW	11.0	
	Case heater	kW	-	
	Lubricant	MEL32		
External finish	Galvanized steel sheets			
External dimension H x W x D	in.	57-1/8 x 34-11/16 x 21-11/16		
	mm	1,450 x 880 x 550		
Protection devices	High pressure protection	High pressure sensor, High pressure switch at 4.15 MPa (601 psi)		
	Inverter circuit	Over-heat protection, Over-current protection		
	Compressor	Over-heat protection		
Refrigerant	Type x original charge	R410A x 13 lbs + 4 oz (6.0 kg)		
	Control	Indoor LEV and BC controller		
Net weight	lbs (kg)	508 (230)		
Heat exchanger	Water volume in plate	G	plate type	
		L	1.32	
	Water pressure Max.	psi	5.0	
		MPa	290	
		2.0		
HIC circuit (HIC: Heat Inter-Changer)		-		
Drawing	External	KL94C211		
	Wiring	KE94G419		
Standard attachment	Document	Installation Manual		
	Accessory	Details refer to External Drw		
Optional parts		joint: CMY-Y102SS-G2, CMY-Y102LS-G2, CMY-R160-J1 Main BC controller: CMB-P108, 1012, 1016NU-JA1, CMB-P1016NU-KA1 Sub BC controller: CMB-P104, 108NU-KB1		
Remarks	<p>Details on foundation work, duct work, insulation work, electrical wiring, power source switch, and other items shall be referred to the Installation Manual.</p> <p>Due to continuing improvement, above specifications may be subject to change without notice.</p> <p>The ambient temperature of the Heat Source Unit needs to be kept below 104°F.D.B. (40°C.D.B.)</p> <p>The ambient relative humidity of the Heat Source Unit needs to be kept below 80%.</p> <p>The Heat Source Unit should not be installed at outdoor.</p> <p>Be sure to mount a strainer (more than 50 meshes) at the water inlet piping of the unit.</p> <p>Be sure to provide interlocking for the unit operation and water circuit.</p> <p>Install the supplied insulation material to the unused drain-socket.</p> <p>When installing insulation material around both water and refrigerant piping, follow the installation manual.</p> <p>The cooling tower and the water circuit must be a closed circuit (water is not exposed to the atmosphere).</p>			

Notes:	Unit converter
1.Nominal cooling conditions (Test conditions are based on AHRI 1230) Indoor: 81°F.D.B./66°F.W.B. (27°C.D.B./19°C.W.B.), Inlet water temperature: 86°F (30°C)	BTU/h =kW x 3.412
2.Nominal heating conditions (Test conditions are based on AHRI 1230) Indoor: 68°F.D.B. (20°C.D.B.), Inlet water temperature: 68°F (20°C)	cfm =m ³ /min x 35.31
	lbs =kg/0.4536
	*Above specification data is subject to rounding variation.

1. SPECIFICATIONS

Heat Source Model		PQR-Y-P192YLMU-A1	
Indoor Model		Non-Ducted	Ducted
Power source		3-phase 3-wire 460 V ±10% 60 Hz	
Cooling capacity (Nominal)	*1	BTU/h	192,000
		kW	56.3
	(460)	Power input	15.05
		Current input	20.9
	(Rated)	BTU/h	183,000
		kW	53.6
(460)		Power input	13.87
		Current input	19.3
		BTU/h	19.7
		kW	14.19
		BTU/h	19.7
		kW	14.19
Temp. range of cooling	Indoor	W.B.	59~75°F (15~24°C)
	Inlet water	°F	50~113°F (10~45°C)
Heating capacity (Nominal)	*2	BTU/h	215,000
		kW	63.0
	(460)	Power input	11.90
		Current input	16.5
	(Rated)	BTU/h	205,000
		kW	60.1
(460)		Power input	10.97
		Current input	15.2
		BTU/h	16.1
		kW	11.56
		BTU/h	16.1
		kW	11.56
Temp. range of heating	Indoor	D.B.	59~81°F (15~27°C)
	Inlet water	°F	50~113°F (10~45°C)
Indoor unit connectable	Total capacity	50~150% of heat source unit capacity	
	Model/Quantity	P04~P96/1~48	
Sound pressure level (measured in anechoic room)		dB <A>	58.0
Refrigerant piping diameter	High pressure	in. (mm)	7/8 (22.2) Brazed
	Low pressure	in. (mm)	1-1/8 (28.58) Brazed
Minimum Circuit Ampacity		A	25
Maximum Overcurrent Protection		A	40
Circulating water	Water flow rate	G/h	1,902
		G/min	31.7
		m ³ /h	7.20
		L/min	120
		cfm	4.2
	Pressure drop	psi	6.38
		kPa	44
	Operating volume range	G/h	1,189 ~ 3,054
		G/min	19.8 ~ 50.9
		m ³ /h	4.5 ~ 11.6
Compressor	Type x Quantity	Inverter scroll hermetic compressor x 1	
	Starting method	Inverter	
	Motor output	kW	12.4
	Case heater	kW	-
	Lubricant	MEL32	
External finish		Galvanized steel sheets	
External dimension H x W x D	in.	57-1/8 x 34-11/16 x 21-11/16	
	mm	1,450 x 880 x 550	
Protection devices	High pressure protection	High pressure sensor, High pressure switch at 4.15 MPa (601 psi)	
	Inverter circuit	Over-heat protection, Over-current protection	
	Compressor	Over-heat protection	
Refrigerant	Type x original charge	R410A x 13 lbs + 4 oz (6.0 kg)	
	Control	Indoor LEV and BC controller	
Net weight		lbs (kg)	508 (230)
Heat exchanger		plate type	
	Water volume in plate	G	1.32
		l	5.0
	Water pressure Max.	psi	290
		MPa	2.0
HIC circuit (HIC: Heat Inter-Changer)		-	
Drawing	External	KL94C211	
	Wiring	KE94G419	
Standard attachment	Document	Installation Manual	
	Accessory	Details refer to External Drw	
Optional parts		joint: CMY-Y102SS-G2, CMY-Y102LS-G2, CMY-R160-J1 Main BC controller: CMB-P108, 1012, 1016NU-JA1, CMB-P1016NU-KA1 Sub BC controller: CMB-P104, 108NU-KB1	
Remarks		<p>Details on foundation work, duct work, insulation work, electrical wiring, power source switch, and other items shall be referred to the Installation Manual.</p> <p>Due to continuing improvement, above specifications may be subject to change without notice.</p> <p>The ambient temperature of the Heat Source Unit needs to be kept below 104°F D.B. (40°C D.B.).</p> <p>The ambient relative humidity of the Heat Source Unit needs to be kept below 80%.</p> <p>The Heat Source Unit should not be installed at outdoor.</p> <p>Be sure to mount a strainer (more than 50 meshes) at the water inlet piping of the unit.</p> <p>Be sure to provide interlocking for the unit operation and water circuit.</p> <p>Install the supplied insulation material to the unused drain-socket.</p> <p>When installing insulation material around both water and refrigerant piping, follow the installation manual.</p> <p>The cooling tower and the water circuit must be a closed circuit (water is not exposed to the atmosphere).</p>	

Notes:	Unit converter
1. Nominal cooling conditions (Test conditions are based on AHRI 1230) Indoor: 81°F D.B./66°F W.B. (27°C D.B./19°C W.B.), Inlet water temperature: 86°F (30°C)	BTU/h = kW x 3,412
2. Nominal heating conditions (Test conditions are based on AHRI 1230) Indoor: 68°F D.B. (20°C D.B.), Inlet water temperature: 68°F (20°C)	cfm = m ³ /min x 35.31
	lbs = kg/0.4536
	*Above specification data is subject to rounding variation.

1. SPECIFICATIONS

WR2-Series

PQRY-P-T(S)LMU-A1, Y(S)LMU-A1

Heat Source Model		PQRY-P216YLMU-A1	
Indoor Model		Non-Ducted	Ducted
Power source		3-phase 3-wire 460 V ±10% 60 Hz	
Cooling capacity (Nominal)	*1	BTU/h	216,000
		kW	63.3
(460)	Power input	kW	19.23
	Current input	A	26.8
(Rated)		BTU/h	206,000
		kW	60.4
(460)	Power input	kW	17.72
	Current input	A	24.7
Temp. range of cooling	Indoor	W.B.	59~75°F (15~24°C)
	Inlet water	°F	50~113°F (10~45°C)
Heating capacity (Nominal)	*2	BTU/h	243,000
		kW	71.2
(460)	Power input	kW	13.04
	Current input	A	18.1
(Rated)		BTU/h	232,000
		kW	68.0
(460)	Power input	kW	12.01
	Current input	A	16.7
Temp. range of heating	Indoor	D.B.	59~81°F (15~27°C)
	Inlet water	°F	50~113°F (10~45°C)
Indoor unit connectable	Total capacity	50~150% of heat source unit capacity	
	Model/Quantity	P04~P96/2~50 (Connectable branch pipe number is max. 48.)	
Sound pressure level (measured in anechoic room)	dB <A>	58.0	
Refrigerant piping diameter	High pressure	in. (mm)	7/8 (22.2) Brazed (1-1/8 (28.58) Brazed for the part that exceeds 65 m)
	Low pressure	in. (mm)	1-1/8 (28.58) Brazed
Minimum Circuit Ampacity	A	31	
Maximum Overcurrent Protection	A	50	
Circulating water	Water flow rate	G/h	3,044
		G/min	50.7
		m ³ /h	11.52
		L/min	192
		cfm	6.8
	Pressure drop	psi	6.53
		kPa	45
Operating volume range	G/h	1,585 ~ 3,804	
	G/min	26.4 ~ 63.4	
	m ³ /h	6.0 ~ 14.4	
Compressor	Type x Quantity	Inverter scroll hermetic compressor x 1	
	Starting method	Inverter	
	Motor output	kW	14.5
	Case heater	kW	0.045
	Lubricant	MEL32	
External finish	Galvanized steel sheets		
External dimension H x W x D	in.	57-1/8 x 34-11/16 x 21-11/16	
	mm	1,450 x 880 x 550	
Protection devices	High pressure protection	High pressure sensor, High pressure switch at 4.15 MPa (601 psi)	
	Inverter circuit	Over-heat protection, Over-current protection	
	Compressor	Over-heat protection	
Refrigerant	Type x original charge	R410A x 25 lbs + 13 oz (11.7 kg)	
	Control	Indoor LEV and BC controller	
Net weight	lbs (kg)	574 (260)	
Heat exchanger	Water volume in plate	G	2.64
		l	10.0
	Water pressure Max.	psi	290
		MPa	2.0
HIC circuit (HIC: Heat Inter-Changer)	-		
Drawing	External	KL94C212	
	Wiring	KE94G419	
Standard attachment	Document	Installation Manual	
	Accessory	Details refer to External Drw	
Optional parts	joint: CMY-Y102SS-G2, CMY-Y102LS-G2, CMY-R160-J1 Main BC controller: CMB-P108, 1012, 1016NU-JA1, CMB-P1016NU-KA1 Sub BC controller: CMB-P104, 108NU-KB1		
Remarks	Details on foundation work, duct work, insulation work, electrical wiring, power source switch, and other items shall be referred to the Installation Manual. Due to continuing improvement, above specifications may be subject to change without notice. The ambient temperature of the Heat Source Unit needs to be kept below 104°F D.B. (40°C D.B.) The ambient relative humidity of the Heat Source Unit needs to be kept below 80%. The Heat Source Unit should not be installed at outdoor. Be sure to mount a strainer (more than 50 meshes) at the water inlet piping of the unit. Be sure to provide interlocking for the unit operation and water circuit. Install the supplied insulation material to the unused drain-socket. When installing insulation material around both water and refrigerant piping, follow the installation manual. When the high pressure piping length is 65 m or less, use 7/8 (22.2) pipe. When the high pressure piping length exceeds 65 m, use 7/8 (22.2) pipe until 65 m, use 1-1/8 (28.58) pipe for the part that exceeds 65 m. The cooling tower and the water circuit must be a closed circuit (water is not exposed to the atmosphere).		

Notes:	Unit converter
1.Nominal cooling conditions (Test conditions are based on AHRI 1230) Indoor: 81°F D.B./66°F W.B. (27°C D.B./19°C W.B.), Inlet water temperature: 86°F (30°C)	BTU/h =kW x 3,412
2.Nominal heating conditions (Test conditions are based on AHRI 1230) Indoor: 68°F D.B. (20°C D.B.), Inlet water temperature: 68°F (20°C)	cfm =m ³ /min x 35.31
	lbs =kg/0.4536
	*Above specification data is subject to rounding variation.

1. SPECIFICATIONS

Heat Source Model		PQRY-P240YLMU-A1		
Indoor Model		Non-Ducted	Ducted	
Power source		3-phase 3-wire 460 V ±10% 60 Hz		
Cooling capacity (Nominal)	*1	BTU/h	224,000	
		kW	65.7	
	(460)	Power input	kW	21.14
		Current input	A	29.4
	(Rated)		BTU/h	228,000
			kW	66.8
(460)	Power input	kW	19.49	
	Current input	A	27.1	
Temp. range of cooling	Indoor	W.B.	59~75°F (15~24°C)	
	Inlet water	°F	50~113°F (10~45°C)	
Heating capacity (Nominal)	*2	BTU/h	270,000	
		kW	79.1	
	(460)	Power input	kW	15.12
		Current input	A	21.0
	(Rated)		BTU/h	258,000
			kW	75.6
(460)	Power input	kW	13.93	
	Current input	A	19.4	
Temp. range of heating	Indoor	D.B.	59~81°F (15~27°C)	
	Inlet water	°F	50~113°F (10~45°C)	
Indoor unit connectable	Total capacity	50~150% of heat source unit capacity		
	Model/Quantity	P04~P96/2~50 (Connectable branch pipe number is max. 48.)		
Sound pressure level (measured in anechoic room)	dB <A>	58.0		
Refrigerant piping diameter	High pressure	in. (mm)	7/8 (22.2) Brazed (1-1/8 (28.58) Brazed for the part that exceeds 65 m)	
	Low pressure	in. (mm)	1-3/8 (34.93) Brazed	
Minimum Circuit Ampacity	A	36		
Maximum Overcurrent Protection	A	60		
Circulating water	Water flow rate	G/h	3,044	
		G/min	50.7	
		m ³ /h	11.52	
		L/min	192	
		cfm	6.8	
	Pressure drop	psi	6.53	
		kPa	45	
	Operating volume range	G/h	1,585 ~ 3,804	
G/min		26.4 ~ 63.4		
m ³ /h		6.0 ~ 14.4		
Compressor	Type x Quantity	Inverter scroll hermetic compressor x 1		
	Starting method	Inverter		
	Motor output	kW	16.1	
	Case heater	kW	0.045	
	Lubricant	MEL32		
External finish	Galvanized steel sheets			
External dimension H x W x D	in.	57-1/8 x 34-11/16 x 21-11/16		
	mm	1,450 x 880 x 550		
Protection devices	High pressure protection	High pressure sensor, High pressure switch at 4.15 MPa (601 psi)		
	Inverter circuit	Over-heat protection, Over-current protection		
	Compressor	Over-heat protection		
Refrigerant	Type x original charge	R410A x 25 lbs + 13 oz (11.7 kg)		
	Control	Indoor LEV and BC controller		
Net weight	lbs (kg)	574 (260)		
Heat exchanger	Water volume in plate	G	2.64	
		l	10.0	
	Water pressure Max.	psi	290	
		MPa	2.0	
HIC circuit (HIC: Heat Inter-Changer)	-			
Drawing	External	KL94C212		
	Wiring	KE94G419		
Standard attachment	Document	Installation Manual		
	Accessory	Details refer to External Drw		
Optional parts	joint: CMY-Y102SS-G2, CMY-Y102LS-G2, CMY-R160-J1 Main BC controller: CMB-P108, 1012, 1016NU-JA1, CMB-P1016NU-KA1 Sub BC controller: CMB-P104, 108NU-KB1			
Remarks	Details on foundation work, duct work, insulation work, electrical wiring, power source switch, and other items shall be referred to the Installation Manual. Due to continuing improvement, above specifications may be subject to change without notice. The ambient temperature of the Heat Source Unit needs to be kept below 104°F D.B. (40°C D.B.). The ambient relative humidity of the Heat Source Unit needs to be kept below 80%. The Heat Source Unit should not be installed at outdoor. Be sure to mount a strainer (more than 50 meshes) at the water inlet piping of the unit. Be sure to provide interlocking for the unit operation and water circuit. Install the supplied insulation material to the unused drain-socket. When installing insulation material around both water and refrigerant piping, follow the installation manual. When the high pressure piping length is 65 m or less, use 7/8 (22.2) pipe. When the high pressure piping length exceeds 65 m, use 7/8 (22.2) pipe until 65 m, use 1-1/8 (28.58) pipe for the part that exceeds 65 m. The cooling tower and the water circuit must be a closed circuit (water is not exposed to the atmosphere).			

Notes: 1.Nominal cooling conditions (Test conditions are based on AHRI 1230) Indoor: 81°F D.B./66°F W.B. (27°C D.B./19°C W.B.), Inlet water temperature: 86°F (30°C) 2.Nominal heating conditions (Test conditions are based on AHRI 1230) Indoor: 68°F D.B. (20°C D.B.), Inlet water temperature: 68°F (20°C)	Unit converter
	BTU/h =kW x 3.412
	cfm =m ³ /min x 35.31
	lbs =kg/0.4536
	*Above specification data is subject to rounding variation.

1. SPECIFICATIONS

PQRY-P-T(S)LMU-A1, Y(S)LMU-A1

Heat Source Model			PQRY-P144YSLMU-A1	
Indoor Model			Non-Ducted	Ducted
Power source			3-phase 3-wire 460 V ±10% 60 Hz	
Cooling capacity (Nominal)	*1	BTU/h	144,000	
		kW	42.2	
	(460)	Power input	7.11	
		Current input	9.9	
	(Rated)	BTU/h	137,000	
		kW	40.2	
(460)	Power input	6.53	7.72	
	Current input	9.1	10.7	
Temp. range of cooling	Indoor	W.B.	59~75°F (15~24°C)	
	Inlet water	°F	50~113°F (10~45°C)	
Heating capacity (Nominal)	*2	BTU/h	160,000	
		kW	46.9	
	(460)	Power input	7.45	
		Current input	10.3	
	(Rated)	BTU/h	152,000	
		kW	44.5	
(460)	Power input	6.86	7.22	
	Current input	9.5	10.0	
Temp. range of heating	Indoor	D.B.	59~81°F (15~27°C)	
	Inlet water	°F	50~113°F (10~45°C)	
Indoor unit connectable	Total capacity	50~150% of heat source unit capacity		
	Model/Quantity	P04~P96/1~36		
Sound pressure level (measured in anechoic room)		dB <A>	49.0	
Refrigerant piping diameter	High pressure	in. (mm)	7/8 (22.2) Brazed	
	Low pressure	in. (mm)	1-1/8 (28.58) Brazed	

Set Model			PQRY-P72YLMU-A1		PQRY-P72YLMU-A1	
Model			PQRY-P72YLMU-A1		PQRY-P72YLMU-A1	
Minimum Circuit Ampacity			6		6	
Maximum Overcurrent Protection			15		15	
Circulating water	Water flow rate	G/h	1,522 + 1,522			
		G/min	25.4 + 25.4			
		m ³ /h	5.76 + 5.76			
		L/min	96 + 96			
		cfm	3.4 + 3.4			
	Pressure drop	psi	3.48		3.48	
kPa		24		24		
Operating volume range	G/h	793 + 793 ~ 1,902 + 1,902				
	G/min	13.2 + 13.2 ~ 31.7 + 31.7				
	m ³ /h	3.0 + 3.0 ~ 7.2 + 7.2				
Compressor	Type x Quantity		Inverter scroll hermetic compressor x 1		Inverter scroll hermetic compressor x 1	
	Starting method		Inverter		Inverter	
	Motor output	kW	4.3		4.3	
	Case heater	kW	-		-	
	Lubricant		MEL32		MEL32	
External finish			Galvanized steel sheets		Galvanized steel sheets	
External dimension H x W x D			in.		43-5/16 x 34-11/16 x 21-11/16	
			mm		1,100 x 880 x 550	
Protection devices	High pressure protection		High pressure sensor, High pressure switch at 4.15 MPa (601 psi)		High pressure sensor, High pressure switch at 4.15 MPa (601 psi)	
	Inverter circuit		Over-heat protection, Over-current protection		Over-heat protection, Over-current protection	
	Compressor		Over-heat protection		Over-heat protection	
Refrigerant	Type x original charge		R410A x 11 lbs + 1 oz (5.0 kg)		R410A x 11 lbs + 1 oz (5.0 kg)	
	Control		Indoor LEV and BC controller			
Net weight			lbs (kg)		406 (184)	
Heat exchanger	Water volume in plate		plate type		plate type	
			G		1.32	
	Water pressure Max.		I		5.0	
			psi		290	
		MPa		2.0		
HIC circuit (HIC: Heat Inter-Change)						
Pipe between unit and distributor	High pressure		in. (mm)		5/8 (15.88) Brazed	
	Low pressure		in. (mm)		3/4 (19.05) Brazed	
Drawing	External		KL94C221			
	Wiring		KE94G419		KE94G419	
Standard attachment	Document		Installation Manual			
	Accessory		Details refer to External Drw			
Optional parts			Heat Source Twinning kit: CMY-Q100CBK2 joint: CMY-Y102SS-G2, CMY-Y102LS-G2, CMY-R160-J1 Main BC controller: CMB-P108, 1012, 1016NU-JA1, CMB-P1016NU-KA1 Sub BC controller: CMB-P104, 108NU-KB1			
Remarks			<p>Details on foundation work, duct work, insulation work, electrical wiring, power source switch, and other items shall be referred to the Installation Manual.</p> <p>Due to continuing improvement, above specifications may be subject to change without notice.</p> <p>The ambient temperature of the Heat Source Unit needs to be kept below 104°F.D.B. (40°C.D.B.)</p> <p>The ambient relative humidity of the Heat Source Unit needs to be kept below 80%.</p> <p>The Heat Source Unit should not be installed at outdoor.</p> <p>Be sure to mount a strainer (more than 50 meshes) at the water inlet piping of the unit.</p> <p>Be sure to provide interlocking for the unit operation and water circuit.</p> <p>The Heat Source twinning kit (low pressure) should be connected to the low pressure side of the heat source unit.</p> <p>Install the supplied insulation material to the unused drain-socket.</p> <p>When installing insulation material around both water and refrigerant piping, follow the installation manual.</p> <p>The cooling tower and the water circuit must be a closed circuit (water is not exposed to the atmosphere).</p>			

Notes:	Unit converter
1.Nominal cooling conditions (Test conditions are based on AHRI 1230) Indoor: 81°F.D.B./66°F.W.B. (27°C.D.B./19°C.W.B.), Inlet water temperature: 86°F (30°C)	BTU/h =kW x 3.412
2.Nominal heating conditions (Test conditions are based on AHRI 1230) Indoor: 68°F.D.B. (20°C.D.B.), Inlet water temperature: 68°F (20°C)	cfm =m ³ /min x 35.31
	lbs =kg/0.4536
	*Above specification data is subject to rounding variation.

1. SPECIFICATIONS

Heat Source Model		PQRY-P168YSLMU-A1		
Indoor Model		Non-Ducted	Ducted	
Power source		3-phase 3-wire 460 V ±10% 60 Hz		
Cooling capacity (Nominal)	*1	BTU/h	168,000	
		kW	49.2	
	(460)	Power input	kW	9.33
		Current input	A	13.0
	(Rated)		BTU/h	161,000
			kW	47.2
(460)	Power input	kW	8.58	
	Current input	A	11.9	
Temp. range of cooling	Indoor	W.B.	59~75°F (15~24°C)	
	Inlet water	°F	50~113°F (10~45°C)	
Heating capacity (Nominal)	*2	BTU/h	188,000	
		kW	55.1	
	(460)	Power input	kW	9.34
		Current input	A	13.0
	(Rated)		BTU/h	179,000
			kW	52.5
(460)	Power input	kW	8.60	
	Current input	A	11.9	
Temp. range of heating	Indoor	D.B.	59~81°F (15~27°C)	
	Inlet water	°F	50~113°F (10~45°C)	
Indoor unit connectable	Total capacity	50~150% of heat source unit capacity		
	Model/Quantity	P04-P96/1~42		
Sound pressure level (measured in anechoic room)	dB <A>	50.0		
Refrigerant piping diameter	High pressure	in. (mm)	7/8 (22.2) Brazed	
	Low pressure	in. (mm)	1-1/8 (28.58) Brazed	

Set Model		PQRY-P96YLMU-A1		PQRY-P72YLMU-A1	
Model		PQRY-P96YLMU-A1		PQRY-P72YLMU-A1	
Minimum Circuit Ampacity		A		6	
Maximum Overcurrent Protection		A		15	
Circulating water	Water flow rate	G/h	1,522 + 1,522		
		G/min	25.4 + 25.4		
		m ³ /h	5.76 + 5.76		
		L/min	96 + 96		
		cfm	3.4 + 3.4		
	Pressure drop	psi	3.48	3.48	
	kPa	24	24		
Operating volume range	G/h	793 + 793 ~ 1,902 + 1,902			
	G/min	13.2 + 13.2 ~ 31.7 + 31.7			
	m ³ /h	3.0 + 3.0 ~ 7.2 + 7.2			
Compressor	Type x Quantity	Inverter scroll hermetic compressor x 1		Inverter scroll hermetic compressor x 1	
	Starting method	Inverter		Inverter	
	Motor output	kW	6.0	4.3	
	Case heater	kW	-	-	
	Lubricant		MEL32	MEL32	
External finish		Galvanized steel sheets		Galvanized steel sheets	
External dimension H x W x D	in.	43-5/16 x 34-11/16 x 21-11/16		43-5/16 x 34-11/16 x 21-11/16	
	mm	1,100 x 880 x 550		1,100 x 880 x 550	
Protection devices	High pressure protection	High pressure sensor, High pressure switch at 4.15 MPa (601 psi)		High pressure sensor, High pressure switch at 4.15 MPa (601 psi)	
	Inverter circuit	Over-heat protection, Over-current protection		Over-heat protection, Over-current protection	
	Compressor	Over-heat protection		Over-heat protection	
Refrigerant	Type x original charge	R410A x 11 lbs + 1 oz (5.0 kg)		R410A x 11 lbs + 1 oz (5.0 kg)	
	Control	Indoor LEV and BC controller			
Net weight	lbs (kg)	406 (184)		406 (184)	
Heat exchanger	Water volume in plate	plate type	plate type		
		G	1.32		
	l	5.0			
	Water pressure Max.	psi	290		
MPa		2.0			
HIC circuit (HIC: Heat Inter-Changer)		-		-	
Pipe between unit and distributor	High pressure	in. (mm)	3/4 (19.05) Brazed		
	Low pressure	in. (mm)	-		
Drawing	External	KL94C221		-	
	Wiring	KE94G419		KE94G419	
Standard attachment	Document	Installation Manual			
	Accessory	Details refer to External Drw			
Optional parts		Heat Source Twinning kit: CMY-Q100CBK2 joint: CMY-Y102SS-G2, CMY-Y102LS-G2, CMY-R160-J1 Main BC controller: CMB-P108, 1012, 1016NU-JA1, CMB-P1016NU-KA1 Sub BC controller: CMB-P104, 108NU-KB1			
Remarks		<p>Details on foundation work, duct work, insulation work, electrical wiring, power source switch, and other items shall be referred to the Installation Manual.</p> <p>Due to continuing improvement, above specifications may be subject to change without notice.</p> <p>The ambient temperature of the Heat Source Unit needs to be kept below 104°F.D.B. (40°C.D.B.)</p> <p>The ambient relative humidity of the Heat Source Unit needs to be kept below 80%.</p> <p>The Heat Source Unit should not be installed at outdoor.</p> <p>Be sure to mount a strainer (more than 50 meshes) at the water inlet piping of the unit.</p> <p>Be sure to provide interlocking for the unit operation and water circuit.</p> <p>The Heat Source twinning kit (low pressure) should be connected to the low pressure side of the heat source unit.</p> <p>Install the supplied insulation material to the unused drain-socket.</p> <p>When installing insulation material around both water and refrigerant piping, follow the installation manual.</p> <p>The cooling tower and the water circuit must be a closed circuit (water is not exposed to the atmosphere).</p>			

Notes:	Unit converter
1.Nominal cooling conditions (Test conditions are based on AHRI 1230) Indoor: 81°F.D.B./66°F.W.B. (27°C.D.B./19°C.W.B.), Inlet water temperature: 86°F (30°C)	BTU/h =kW x 3,412
2.Nominal heating conditions (Test conditions are based on AHRI 1230) Indoor: 68°F.D.B. (20°C.D.B.), Inlet water temperature: 68°F (20°C)	cfm =m ³ /min x 35.31
	lbs =kg/0.4536
	*Above specification data is subject to rounding variation.

1. SPECIFICATIONS

WR2-Series

PQRY-P-T(S)LMU-A1, Y(S)LMU-A1

Heat Source Model			PQRY-P192YSLMU-A1			
Indoor Model			Non-Ducted		Ducted	
Power source			3-phase 3-wire 460 V ±10% 60 Hz			
Cooling capacity (Nominal)	*1	BTU/h	192,000			
		kW	56.3			
	(460)	Power input	kW	11.30		
		Current input	A	15.7		
	(Rated)	(460)	BTU/h	183,000		
			kW	53.6		
(460)	Power input	kW	10.40	10.98		
	Current input	A	14.5	15.3		
Temp. range of cooling	Indoor	W.B.	59~75°F (15~24°C)			
	Inlet water	°F	50~113°F (10~45°C)			
Heating capacity (Nominal)	*2	BTU/h	215,000			
		kW	63.0			
	(460)	Power input	kW	11.02		
		Current input	A	15.3		
	(Rated)	(460)	BTU/h	205,000		
			kW	60.1		
(460)	Power input	kW	10.16	8.90		
	Current input	A	14.1	12.4		
Temp. range of heating	Indoor	D.B.	59~81°F (15~27°C)			
	Inlet water	°F	50~113°F (10~45°C)			
Indoor unit connectable	Total capacity	50~150% of heat source unit capacity				
	Model/Quantity	P04-P96/1-48				
Sound pressure level (measured in anechoic room)	dB <A>	51.0				
Refrigerant piping diameter	High pressure	in. (mm)	7/8 (22.2) Brazed			
	Low pressure	in. (mm)	1-1/8 (28.58) Brazed			

Set Model			PQRY-P96YLMU-A1		PQRY-P96YLMU-A1	
Model			PQRY-P96YLMU-A1		PQRY-P96YLMU-A1	
Minimum Circuit Ampacity	A	9		9		
Maximum Overcurrent Protection	A	15		15		
Circulating water	Water flow rate	G/h	1,522 + 1,522			
		G/min	25.4 + 25.4			
		m ³ /h	5.76 + 5.76			
		L/min	96 + 96			
		cfm	3.4 + 3.4			
	Pressure drop	psi	3.48	3.48		
	kPa	24	24			
Operating volume range	G/h	793 + 793 ~ 1,902 + 1,902				
	G/min	13.2 + 13.2 ~ 31.7 + 31.7				
	m ³ /h	3.0 + 3.0 ~ 7.2 + 7.2				
Compressor	Type x Quantity	Inverter scroll hermetic compressor x 1		Inverter scroll hermetic compressor x 1		
	Starting method	Inverter		Inverter		
	Motor output	kW	6.0		6.0	
	Case heater	kW	-		-	
	Lubricant	MEL32		MEL32		
External finish	Galvanized steel sheets		Galvanized steel sheets			
External dimension H x W x D	in.	43-5/16 x 34-11/16 x 21-11/16		43-5/16 x 34-11/16 x 21-11/16		
	mm	1,100 x 880 x 550		1,100 x 880 x 550		
Protection devices	High pressure protection	High pressure sensor, High pressure switch at 4.15 MPa (601 psi)		High pressure sensor, High pressure switch at 4.15 MPa (601 psi)		
	Inverter circuit	Over-heat protection, Over-current protection		Over-heat protection, Over-current protection		
	Compressor	Over-heat protection		Over-heat protection		
Refrigerant	Type x original charge	R410A x 11 lbs + 1 oz (5.0 kg)		R410A x 11 lbs + 1 oz (5.0 kg)		
	Control	Indoor LEV and BC controller				
Net weight	lbs (kg)	406 (184)		406 (184)		
Heat exchanger	Water volume in plate	plate type			plate type	
		G	1.32		1.32	
	I	5.0		5.0		
	Water pressure Max.	psi	290		290	
	MPa	2.0		2.0		
HIC circuit (HIC: Heat Inter-Changer)						
Pipe between unit and distributor	High pressure	in. (mm)	3/4 (19.05) Brazed		3/4 (19.05) Brazed	
	Low pressure	in. (mm)	-		7/8 (22.2) Brazed	
Drawing	External	KL94C221				
	Wiring	KE94G419		KE94G419		
Standard attachment	Document	Installation Manual				
	Accessory	Details refer to External Drw				
Optional parts	Heat Source Twinning kit: CMY-Q100CBK2 joint: CMY-Y102SS-G2, CMY-Y102LS-G2, CMY-R160-J1 Main BC controller: CMB-P108, 1012, 1016NU-JA1, CMB-P1016NU-KA1 Sub BC controller: CMB-P104, 108NU-KB1					
Remarks	Details on foundation work, duct work, insulation work, electrical wiring, power source switch, and other items shall be referred to the Installation Manual. Due to continuing improvement, above specifications may be subject to change without notice. The ambient temperature of the Heat Source Unit needs to be kept below 104°F.D.B. (40°C.D.B.) The ambient relative humidity of the Heat Source Unit needs to be kept below 80%. The Heat Source Unit should not be installed at outdoor. Be sure to mount a strainer (more than 50 meshes) at the water inlet piping of the unit. Be sure to provide interlocking for the unit operation and water circuit. The Heat Source twinning kit (low pressure) should be connected to the low pressure side of the heat source unit. Install the supplied insulation material to the unused drain-socket. When installing insulation material around both water and refrigerant piping, follow the installation manual. The cooling tower and the water circuit must be a closed circuit (water is not exposed to the atmosphere).					

Notes:	Unit converter
1.Nominal cooling conditions (Test conditions are based on AHRI 1230) Indoor: 81°F.D.B./66°F.W.B. (27°C.D.B./19°C.W.B.), Inlet water temperature: 86°F (30°C)	BTU/h =kW x 3.412
2.Nominal heating conditions (Test conditions are based on AHRI 1230) Indoor: 68°F.D.B. (20°C.D.B.), Inlet water temperature: 68°F (20°C)	cfm =m ³ /min x 35.31
	lbs =kg/0.4536
	*Above specification data is subject to rounding variation.

1. SPECIFICATIONS

Heat Source Model		PQRY-P216YSLMU-A1		
Indoor Model		Non-Ducted	Ducted	
Power source		3-phase 3-wire 460 V ±10% 60 Hz		
Cooling capacity (Nominal)	*1	BTU/h	216,000	
		kW	63.3	
	(460)	Power input	kW	14.03
		Current input	A	19.5
	(Rated)		BTU/h	206,000
			kW	60.4
(460)	Power input	kW	12.93	
	Current input	A	18.0	
Temp. range of cooling	Indoor	W.B.	59~75°F (15~24°C)	
	Inlet water	°F	50~113°F (10~45°C)	
Heating capacity (Nominal)	*2	BTU/h	243,000	
		kW	71.2	
	(460)	Power input	kW	12.88
		Current input	A	17.9
	(Rated)		BTU/h	232,000
			kW	68.0
(460)	Power input	kW	11.88	
	Current input	A	16.5	
Temp. range of heating	Indoor	D.B.	59~81°F (15~27°C)	
	Inlet water	°F	50~113°F (10~45°C)	
Indoor unit connectable	Total capacity	50~150% of heat source unit capacity		
	Model/Quantity	P04~P96/2~50 (Connectable branch pipe number is max. 48.)		
Sound pressure level (measured in anechoic room)	dB <A>	55.0		
Refrigerant piping diameter	High pressure	in. (mm) 7/8 (22.2) Brazed (1-1/8 (28.58) Brazed for the part that exceeds 65 m)		
	Low pressure	in. (mm) 1-1/8 (28.58) Brazed		

Set Model		PQRY-P120YLMU-A1		PQRY-P96YLMU-A1	
Model		PQRY-P120YLMU-A1		PQRY-P96YLMU-A1	
Minimum Circuit Ampacity		A 13		A 9	
Maximum Overcurrent Protection		A 20		A 15	
Circulating water	Water flow rate	G/h	1,522 + 1,522		
		G/min	25.4 + 25.4		
		m ³ /h	5.76 + 5.76		
		L/min	96 + 96		
		cfm	3.4 + 3.4		
	Pressure drop	psi	3.48	3.48	
	kPa	24	24		
Operating volume range		G/h	793 + 793 ~ 1,902 + 1,902		
		G/min	13.2 + 13.2 ~ 31.7 + 31.7		
		m ³ /h	3.0 + 3.0 ~ 7.2 + 7.2		
Compressor	Type x Quantity	Inverter scroll hermetic compressor x 1		Inverter scroll hermetic compressor x 1	
	Starting method	Inverter		Inverter	
	Motor output	kW	7.7	6.0	
	Case heater	kW	-	-	
	Lubricant		MEL32	MEL32	
External finish		Galvanized steel sheets		Galvanized steel sheets	
External dimension H x W x D	in.	43-5/16 x 34-11/16 x 21-11/16		43-5/16 x 34-11/16 x 21-11/16	
	mm	1,100 x 880 x 550		1,100 x 880 x 550	
Protection devices	High pressure protection	High pressure sensor, High pressure switch at 4.15 MPa (601 psi)		High pressure sensor, High pressure switch at 4.15 MPa (601 psi)	
	Inverter circuit	Over-heat protection, Over-current protection		Over-heat protection, Over-current protection	
	Compressor	Over-heat protection		Over-heat protection	
Refrigerant	Type x original charge	R410A x 11 lbs + 1 oz (5.0 kg)		R410A x 11 lbs + 1 oz (5.0 kg)	
	Control	Indoor LEV and BC controller			
Net weight	lbs (kg)	406 (184)		406 (184)	
Heat exchanger	Water volume in plate	plate type		plate type	
		G	1.32	1.32	
	l	5.0	5.0		
	Water pressure Max.	psi	290	290	
MPa		2.0	2.0		
HIC circuit (HIC: Heat Inter-Changer)		-		-	
Pipe between unit and distributor	High pressure	in. (mm) 3/4 (19.05) Brazed		3/4 (19.05) Brazed	
	Low pressure	in. (mm) -		7/8 (22.2) Brazed	
Drawing	External	KL94C221		KL94C221	
	Wiring	KE94G419		KE94G419	
Standard attachment	Document	Installation Manual			
	Accessory	Details refer to External Drw			
Optional parts	Heat Source Twinning kit: CMY-Q100CBK2 joint: CMY-Y102SS-G2, CMY-Y102LS-G2, CMY-R160-J1 Main BC controller: CMB-P108, 1012, 1016NU-JA1, CMB-P1016NU-KA1 Sub BC controller: CMB-P104, 108NU-KB1				
Remarks	Details on foundation work, duct work, insulation work, electrical wiring, power source switch, and other items shall be referred to the Installation Manual. Due to continuing improvement, above specifications may be subject to change without notice. The ambient temperature of the Heat Source Unit needs to be kept below 104°F.D.B. (40°C.D.B.) The ambient relative humidity of the Heat Source Unit needs to be kept below 80%. The Heat Source Unit should not be installed at outdoor. Be sure to mount a strainer (more than 50 meshes) at the water inlet piping of the unit. Be sure to provide interlocking for the unit operation and water circuit. The Heat Source twinning kit (low pressure) should be connected to the low pressure side of the heat source unit. Install the supplied insulation material to the unused drain-socket. When installing insulation material around both water and refrigerant piping, follow the installation manual. When the high pressure piping length is 65 m or less, use 7/8 (22.2) pipe. When the high pressure piping length exceeds 65 m, use 1-1/8 (28.58) pipe until 65 m, use 1-1/8 (28.58) pipe for the part that exceeds 65 m. The cooling tower and the water circuit must be a closed circuit (water is not exposed to the atmosphere).				

Notes:	Unit converter
1. Nominal cooling conditions (Test conditions are based on AHRI 1230) Indoor: 81°F.D.B./66°F.W.B. (27°C.D.B./19°C.W.B.), Inlet water temperature: 86°F (30°C)	BTU/h =kW x 3,412
2. Nominal heating conditions (Test conditions are based on AHRI 1230) Indoor: 68°F.D.B. (20°C.D.B.), Inlet water temperature: 68°F (20°C)	cfm =m ³ /min x 35.31
	lbs =kg/0.4536
	*Above specification data is subject to rounding variation.

1. SPECIFICATIONS

PQRY-P-T(S)LMU-A1, Y(S)LMU-A1

Heat Source Model			PQRY-P240YSLMU-A1		
Indoor Model			Non-Ducted	Ducted	
Power source			3-phase 3-wire 460 V ±10% 60 Hz		
Cooling capacity (Nominal)	*1	BTU/h	240,000		
		kW	70.3		
	(460)	Power input	kW	16.89	
		Current input	A	23.5	
	(Rated)	(460)	BTU/h	228,000	
			kW	66.8	
(460)	Power input	kW	15.57	16.15	
	Current input	A	21.7	22.5	
Temp. range of cooling	Indoor	W.B.	59~75°F (15~24°C)		
	Inlet water	°F	50~113°F (10~45°C)		
Heating capacity (Nominal)	*2	BTU/h	270,000		
		kW	79.1		
	(460)	Power input	kW	14.58	
		Current input	A	20.3	
	(Rated)	(460)	BTU/h	258,000	
			kW	75.6	
(460)	Power input	kW	13.45	12.02	
	Current input	A	18.7	16.7	
Temp. range of heating	Indoor	D.B.	59~81°F (15~27°C)		
	Inlet water	°F	50~113°F (10~45°C)		
Indoor unit connectable	Total capacity	50~150% of heat source unit capacity			
	Model/Quantity	P04~P96/2~50 (Connectable branch pipe number is max. 48.)			
Sound pressure level (measured in anechoic room)	dB <A>	57.0			
Refrigerant piping diameter	High pressure	in. (mm)	7/8 (22.2) Brazed (1-1/8 (28.58) Brazed for the part that exceeds 65 m)		
	Low pressure	in. (mm)	1-3/8 (34.93) Brazed		

Set Model			PQRY-P120YLMU-A1	
Model			PQRY-P120YLMU-A1	PQRY-P120YLMU-A1
Minimum Circuit Ampacity			A	13
Maximum Overcurrent Protection			A	20
Circulating water	Water flow rate	G/h	1,522 + 1,522	
		G/min	25.4 + 25.4	
		m ³ /h	5.76 + 5.76	
		L/min	96 + 96	
		cfm	3.4 + 3.4	
	Pressure drop	psi	3.48	3.48
Operating volume range	kPa	24	24	
	G/h	793 + 793 ~ 1,902 + 1,902		
	G/min	13.2 + 13.2 ~ 31.7 + 31.7		
Compressor	Type x Quantity	Inverter scroll hermetic compressor x 1		Inverter scroll hermetic compressor x 1
	Starting method	Inverter		Inverter
	Motor output	kW	7.7	7.7
	Case heater	kW	-	-
Lubricant	MEL32		MEL32	
	External finish			
External dimension H x W x D			Galvanized steel sheets	
Protection devices	High pressure protection	High pressure sensor, High pressure switch at 4.15 MPa (601 psi)		High pressure sensor, High pressure switch at 4.15 MPa (601 psi)
	Inverter circuit	Over-heat protection, Over-current protection		Over-heat protection, Over-current protection
Refrigerant	Compressor	Over-heat protection		Over-heat protection
	Type x original charge	R410A x 11 lbs + 1 oz (5.0 kg)		R410A x 11 lbs + 1 oz (5.0 kg)
	Control	Indoor LEV and BC controller		
Net weight	lbs (kg)	406 (184)		406 (184)
Heat exchanger	Water volume in plate	plate type	plate type	
		G	1.32	
	l	5.0		
	Water pressure Max.	psi	290	
	MPa	2.0		
HIC circuit (HIC: Heat Inter-Changer)				
Pipe between unit and distributor	High pressure	in. (mm)	3/4 (19.05) Brazed	
	Low pressure	in. (mm)	7/8 (22.2) Brazed	
Drawing	External	KL94C221		
	Wiring	KE94G419	KE94G419	
Standard attachment	Document	Installation Manual		
	Accessory	Details refer to External Drw		
Optional parts	Heat Source Twinning kit: CMY-Q100CBK2 joint: CMY-Y102SS-G2, CMY-Y102LS-G2, CMY-R160-J1 Main BC controller: CMB-P108, 1012, 1016NU-JA1, CMB-P1016NU-KA1 Sub BC controller: CMB-P104, 108NU-KB1			
Remarks	<p>Details on foundation work, duct work, insulation work, electrical wiring, power source switch, and other items shall be referred to the Installation Manual.</p> <p>Due to continuing improvement, above specifications may be subject to change without notice.</p> <p>The ambient temperature of the Heat Source Unit needs to be kept below 104°F D.B. (40°C D.B.)</p> <p>The ambient relative humidity of the Heat Source Unit needs to be kept below 80%.</p> <p>The Heat Source Unit should not be installed at outdoor.</p> <p>Be sure to mount a strainer (more than 50 meshes) at the water inlet piping of the unit.</p> <p>Be sure to provide interlocking for the unit operation and water circuit.</p> <p>The Heat Source twinning kit (low pressure) should be connected to the low pressure side of the heat source unit.</p> <p>Install the supplied insulation material to the unused drain-socket.</p> <p>When installing insulation material around both water and refrigerant piping, follow the installation manual.</p> <p>When the high pressure piping length is 65 m or less, use 7/8 (22.2) pipe. When the high pressure piping length exceeds 65 m, use 1-1/8 (28.58) pipe until 65 m, use 1-1/8 (28.58) pipe for the part that exceeds 65 m.</p> <p>The cooling tower and the water circuit must be a closed circuit (water is not exposed to the atmosphere).</p>			

Notes:	Unit converter
1. Nominal cooling conditions (Test conditions are based on AHRI 1230) Indoor: 81°F D.B./66°F W.B. (27°C D.B./19°C W.B.), Inlet water temperature: 86°F (30°C)	BTU/h = kW x 3.412
2. Nominal heating conditions (Test conditions are based on AHRI 1230) Indoor: 68°F D.B. (20°C D.B.), Inlet water temperature: 68°F (20°C)	cfm = m ³ /min x 35.31
	lbs = kg/0.4536
	*Above specification data is subject to rounding variation.

1. SPECIFICATIONS

Heat Source Model		PQRY-P288YSLMU-A1		
Indoor Model		Non-Ducted	Ducted	
Power source		3-phase 3-wire 460 V ±10% 60 Hz		
Cooling capacity (Nominal)	*1	BTU/h	288,000	
		kW	84.4	
	(460)	Power input	kW	20.42
		Current input	A	28.4
	(Rated)		BTU/h	275,000
			kW	80.6
(460)		Power input	kW	18.82
		Current input	A	26.2
Temp. range of cooling	Indoor	W.B.	59~75°F (15~24°C)	
	Inlet water	°F	50~113°F (10~45°C)	
Heating capacity (Nominal)	*2	BTU/h	323,000	
		kW	94.7	
	(460)	Power input	kW	17.50
		Current input	A	24.4
	(Rated)		BTU/h	308,000
			kW	90.3
(460)		Power input	kW	16.13
		Current input	A	22.4
Temp. range of heating	Indoor	D.B.	59~81°F (15~27°C)	
	Inlet water	°F	50~113°F (10~45°C)	
Indoor unit connectable	Total capacity	50~150% of heat source unit capacity		
	Model/Quantity	P04~P96/2~50 (Connectable branch pipe number is max. 48.)		
Sound pressure level (measured in anechoic room)	dB <A>	57.0		
Refrigerant piping diameter	High pressure	in. (mm)	1-1/8 (28.58) Brazed	
	Low pressure	in. (mm)	1-3/8 (34.93) Brazed	

Set Model		PQRY-P144YLMU-A1		PQRY-P144YLMU-A1	
Model		PQRY-P144YLMU-A1		PQRY-P144YLMU-A1	
Minimum Circuit Ampacity		A	16	16	
Maximum Overcurrent Protection		A	25	25	
Circulating water	Water flow rate	G/h	1,902 + 1,902		
		G/min	31.7 + 31.7		
		m ³ /h	7.20 + 7.20		
		L/min	120 + 120		
		cfm	4.2 + 4.2		
	Pressure drop	psi	6.38	6.38	
	kPa	44	44		
Operating volume range		G/h	1,189 + 1,189 ~ 3,054 + 3,054		
		G/min	19.8 + 19.8 ~ 50.9 + 50.9		
		m ³ /h	4.5 + 4.5 ~ 11.6 + 11.6		
Compressor	Type x Quantity	Inverter scroll hermetic compressor x 1		Inverter scroll hermetic compressor x 1	
	Starting method	Inverter		Inverter	
	Motor output	kW	9.5	9.5	
	Case heater	kW	-	-	
	Lubricant		MEL32	MEL32	
External finish		Galvanized steel sheets		Galvanized steel sheets	
External dimension H x W x D	in.	57-1/8 x 34-11/16 x 21-11/16		57-1/8 x 34-11/16 x 21-11/16	
	mm	1,450 x 880 x 550		1,450 x 880 x 550	
Protection devices	High pressure protection	High pressure sensor, High pressure switch at 4.15 MPa (601 psi)		High pressure sensor, High pressure switch at 4.15 MPa (601 psi)	
	Inverter circuit	Over-heat protection, Over-current protection		Over-heat protection, Over-current protection	
	Compressor	Over-heat protection		Over-heat protection	
Refrigerant	Type x original charge	R410A x 13 lbs + 4 oz (6.0 kg)		R410A x 13 lbs + 4 oz (6.0 kg)	
	Control	Indoor LEV and BC controller			
Net weight	lbs (kg)	508 (230)		508 (230)	
Heat exchanger	Water volume in plate	plate type			plate type
		G	1.32		1.32
	l	5.0		5.0	
	Water pressure Max.	psi	290		290
MPa		2.0		2.0	
HIC circuit (HIC: Heat Inter-Changer)		-		-	
Pipe between unit and distributor	High pressure	in. (mm)	7/8 (22.2) Brazed		7/8 (22.2) Brazed
	Low pressure	in. (mm)	-		1-1/8 (28.58) Brazed
Drawing	External	KL94C222		KL94C222	
	Wiring	KE94G419		KE94G419	
Standard attachment	Document	Installation Manual			
	Accessory	Details refer to External Drw			
Optional parts	Heat Source Twinning kit: CMY-Q200CBK joint: CMY-Y102SS-G2, CMY-Y102LS-G2, CMY-R160-J1 Main BC controller: CMB-P108, 1012, 1016NU-JA1, CMB-P1016NU-KA1 Sub BC controller: CMB-P104, 108NU-KB1				
Remarks	Details on foundation work, duct work, insulation work, electrical wiring, power source switch, and other items shall be referred to the Installation Manual. Due to continuing improvement, above specifications may be subject to change without notice. The ambient temperature of the Heat Source Unit needs to be kept below 104°F.D.B. (40°C.D.B.) The ambient relative humidity of the Heat Source Unit needs to be kept below 80%. The Heat Source Unit should not be installed at outdoor. Be sure to mount a strainer (more than 50 meshes) at the water inlet piping of the unit. Be sure to provide interlocking for the unit operation and water circuit. The Heat Source twinning kit (low pressure) should be connected to the low pressure side of the heat source unit. Install the supplied insulation material to the unused drain-socket. When installing insulation material around both water and refrigerant piping, follow the installation manual. The cooling tower and the water circuit must be a closed circuit (water is not exposed to the atmosphere).				

Notes:	Unit converter
1.Nominal cooling conditions (Test conditions are based on AHRI 1230) Indoor: 81°F.D.B./66°F.W.B. (27°C.D.B./19°C.W.B.), Inlet water temperature: 86°F (30°C)	BTU/h =kW x 3,412
2.Nominal heating conditions (Test conditions are based on AHRI 1230) Indoor: 68°F.D.B. (20°C.D.B.), Inlet water temperature: 68°F (20°C)	cfm =m ³ /min x 35.31
	lbs =kg/0.4536
	*Above specification data is subject to rounding variation.

1. SPECIFICATIONS

WR2-Series

PQRY-P-T(S)LMU-A1, Y(S)LMU-A1

Heat Source Model			PQRY-P312YSLMU-A1			
Indoor Model			Non-Ducted		Ducted	
Power source			3-phase 3-wire 460 V ±10% 60 Hz			
Cooling capacity (Nominal)	*1	BTU/h	312,000			
		kW	91.4			
		Power input kW	23.41			
		(460) Current input A	32.6			
		(Rated)	BTU/h	297,000		
			kW	87.0		
(460)	Power input kW	21.59	23.67			
	Current input A	30.1	33.0			
Temp. range of cooling	Indoor	W.B.	59~75°F (15~24°C)			
	Inlet water	°F	50~113°F (10~45°C)			
Heating capacity (Nominal)	*2	BTU/h	350,000			
		kW	102.6			
		Power input kW	19.11			
		(460) Current input A	26.6			
		(Rated)	BTU/h	334,000		
			kW	97.9		
(460)	Power input kW	17.62	17.96			
	Current input A	24.5	25.0			
Temp. range of heating	Indoor	D.B.	59~81°F (15~27°C)			
	Inlet water	°F	50~113°F (10~45°C)			
Indoor unit connectable	Total capacity	50~150% of heat source unit capacity				
	Model/Quantity	P04~P96/2~50 (Connectable branch pipe number is max. 48.)				
Sound pressure level (measured in anechoic room)	dB <A>	58.0				
Refrigerant piping diameter	High pressure	in. (mm)	1-1/8 (28.58) Brazed			
	Low pressure	in. (mm)	1-3/8 (34.93) Brazed			

Set Model			PQRY-P168YLMU-A1		PQRY-P144YLMU-A1
Model			PQRY-P168YLMU-A1		PQRY-P144YLMU-A1
Minimum Circuit Ampacity			A		16
Maximum Overcurrent Protection			A		25
Circulating water	Water flow rate	G/h	1,902 + 1,902		
		G/min	31.7 + 31.7		
		m ³ /h	7.20 + 7.20		
		L/min	120 + 120		
		cfm	4.2 + 4.2		
	Pressure drop	psi	6.38	6.38	
	kPa	44	44		
Operating volume range	G/h	1,189 + 1,189 ~ 3,054 + 3,054			
	G/min	19.8 + 19.8 ~ 50.9 + 50.9			
	m ³ /h	4.5 + 4.5 ~ 11.6 + 11.6			
Compressor	Type x Quantity	Inverter scroll hermetic compressor x 1		Inverter scroll hermetic compressor x 1	
	Starting method	Inverter		Inverter	
	Motor output kW	11.0		9.5	
	Case heater kW	-		-	
	Lubricant	MEL32		MEL32	
External finish			Galvanized steel sheets		Galvanized steel sheets
External dimension H x W x D	in.	57-1/8 x 34-11/16 x 21-11/16		57-1/8 x 34-11/16 x 21-11/16	
	mm	1,450 x 880 x 550		1,450 x 880 x 550	
Protection devices	High pressure protection	High pressure sensor, High pressure switch at 4.15 MPa (601 psi)		High pressure sensor, High pressure switch at 4.15 MPa (601 psi)	
	Inverter circuit	Over-heat protection, Over-current protection		Over-heat protection, Over-current protection	
	Compressor	Over-heat protection		Over-heat protection	
Refrigerant	Type x original charge	R410A x 13 lbs + 4 oz (6.0 kg)		R410A x 13 lbs + 4 oz (6.0 kg)	
	Control	Indoor LEV and BC controller			
Net weight	lbs (kg)	508 (230)		508 (230)	
Heat exchanger	Water volume in plate	plate type	plate type		plate type
		G	1.32		1.32
	I	5.0		5.0	
	Water pressure Max.	psi	290		290
	MPa	2.0		2.0	
HIC circuit (HIC: Heat Inter-Changer)			-		-
Pipe between unit and distributor	High pressure	in. (mm)	7/8 (22.2) Brazed		7/8 (22.2) Brazed
	Low pressure	in. (mm)	-		1-1/8 (28.58) Brazed
Drawing	External	KL94C222			
	Wiring	KE94G419		KE94G419	
Standard attachment	Document	Installation Manual			
	Accessory	Details refer to External Drw			
Optional parts			Heat Source Twinning kit: CMY-Q200CBK joint: CMY-Y102SS-G2, CMY-Y102LS-G2, CMY-R160-J1 Main BC controller: CMB-P108, 1012, 1016NU-JA1, CMB-P1016NU-KA1 Sub BC controller: CMB-P104, 108NU-KB1		
Remarks			<p>Details on foundation work, duct work, insulation work, electrical wiring, power source switch, and other items shall be referred to the Installation Manual.</p> <p>Due to continuing improvement, above specifications may be subject to change without notice.</p> <p>The ambient temperature of the Heat Source Unit needs to be kept below 104°F.D.B. (40°C.D.B.)</p> <p>The ambient relative humidity of the Heat Source Unit needs to be kept below 80%.</p> <p>The Heat Source Unit should not be installed at outdoor.</p> <p>Be sure to mount a strainer (more than 50 meshes) at the water inlet piping of the unit.</p> <p>Be sure to provide interlocking for the unit operation and water circuit.</p> <p>The Heat Source twinning kit (low pressure) should be connected to the low pressure side of the heat source unit.</p> <p>Install the supplied insulation material to the unused drain-socket.</p> <p>When installing insulation material around both water and refrigerant piping, follow the installation manual.</p> <p>The cooling tower and the water circuit must be a closed circuit (water is not exposed to the atmosphere).</p>		

Notes:	Unit converter
1.Nominal cooling conditions (Test conditions are based on AHRI 1230) Indoor: 81°F.D.B./66°F.W.B. (27°C.D.B./19°C.W.B.), Inlet water temperature: 86°F (30°C)	BTU/h =kW x 3.412
2.Nominal heating conditions (Test conditions are based on AHRI 1230) Indoor: 68°F.D.B. (20°C.D.B.), Inlet water temperature: 68°F (20°C)	cfm =m ³ /min x 35.31
	lbs =kg/0.4536
	*Above specification data is subject to rounding variation.

1. SPECIFICATIONS

Heat Source Model		PQRY-P336YSLMU-A1		
Indoor Model		Non-Ducted	Ducted	
Power source		3-phase 3-wire 460 V ±10% 60 Hz		
Cooling capacity (Nominal)	*1	BTU/h	336,000	
		kW	98.5	
	(460)	Power input	kW	26.84
		Current input	A	37.4
	(Rated)		BTU/h	320,000
			kW	93.8
(460)	Power input	kW	24.76	
	Current input	A	34.5	
Temp. range of cooling	Indoor	W.B.	59~75°F (15~24°C)	
	Inlet water	°F	50~113°F (10~45°C)	
Heating capacity (Nominal)	*2	BTU/h	378,000	
		kW	110.8	
	(460)	Power input	kW	20.77
		Current input	A	28.9
	(Rated)		BTU/h	361,000
			kW	105.8
(460)	Power input	kW	19.16	
	Current input	A	26.7	
Temp. range of heating	Indoor	D.B.	59~81°F (15~27°C)	
	Inlet water	°F	50~113°F (10~45°C)	
Indoor unit connectable	Total capacity	50~150% of heat source unit capacity		
	Model/Quantity	P04~P96/2~50 (Connectable branch pipe number is max. 48.)		
Sound pressure level (measured in anechoic room)	dB <A>	59.0		
Refrigerant piping diameter	High pressure	in. (mm)	1-1/8 (28.58) Brazed	
	Low pressure	in. (mm)	1-5/8 (41.28) Brazed	

Set Model		PQRY-P168YLMU-A1		PQRY-P168YLMU-A1	
Model		PQRY-P168YLMU-A1		PQRY-P168YLMU-A1	
Minimum Circuit Ampacity		A	20	20	
Maximum Overcurrent Protection		A	35	35	
Circulating water	Water flow rate	G/h	1,902 + 1,902		
		G/min	31.7 + 31.7		
		m ³ /h	7.20 + 7.20		
		L/min	120 + 120		
		cfm	4.2 + 4.2		
	Pressure drop	psi	6.38	6.38	
	kPa	44	44		
Operating volume range	G/h	1,189 + 1,189 ~ 3,054 + 3,054			
	G/min	19.8 + 19.8 ~ 50.9 + 50.9			
	m ³ /h	4.5 + 4.5 ~ 11.6 + 11.6			
Compressor	Type x Quantity	Inverter scroll hermetic compressor x 1		Inverter scroll hermetic compressor x 1	
	Starting method	Inverter		Inverter	
	Motor output	kW	11.0	11.0	
	Case heater	kW	-	-	
	Lubricant		MEL32	MEL32	
External finish		Galvanized steel sheets		Galvanized steel sheets	
External dimension H x W x D	in.	57-1/8 x 34-11/16 x 21-11/16		57-1/8 x 34-11/16 x 21-11/16	
	mm	1,450 x 880 x 550		1,450 x 880 x 550	
Protection devices	High pressure protection	High pressure sensor, High pressure switch at 4.15 MPa (601 psi)		High pressure sensor, High pressure switch at 4.15 MPa (601 psi)	
	Inverter circuit	Over-heat protection, Over-current protection		Over-heat protection, Over-current protection	
	Compressor	Over-heat protection		Over-heat protection	
Refrigerant	Type x original charge	R410A x 13 lbs + 4 oz (6.0 kg)		R410A x 13 lbs + 4 oz (6.0 kg)	
	Control	Indoor LEV and BC controller			
Net weight	lbs (kg)	508 (230)		508 (230)	
Heat exchanger	Water volume in plate	plate type	plate type		
		G	1.32		
	l	5.0			
	Water pressure Max.	psi	290		
MPa		2.0			
HIC circuit (HIC: Heat Inter-Changer)		-		-	
Pipe between unit and distributor	High pressure	in. (mm)	7/8 (22.2) Brazed		
	Low pressure	in. (mm)	-		
Drawing	External	KL94C222		KL94C222	
	Wiring	KE94G419		KE94G419	
Standard attachment	Document	Installation Manual			
	Accessory	Details refer to External Drw			
Optional parts	Heat Source Twinning kit: CMY-Q200CBK joint: CMY-Y102SS-G2, CMY-Y102LS-G2, CMY-R160-J1 Main BC controller: CMB-P108, 1012, 1016NU-JA1, CMB-P1016NU-KA1 Sub BC controller: CMB-P104, 108NU-KB1				
Remarks	Details on foundation work, duct work, insulation work, electrical wiring, power source switch, and other items shall be referred to the Installation Manual. Due to continuing improvement, above specifications may be subject to change without notice. The ambient temperature of the Heat Source Unit needs to be kept below 104°F.D.B. (40°C.D.B.) The ambient relative humidity of the Heat Source Unit needs to be kept below 80%. The Heat Source Unit should not be installed at outdoor. Be sure to mount a strainer (more than 50 meshes) at the water inlet piping of the unit. Be sure to provide interlocking for the unit operation and water circuit. The Heat Source twinning kit (low pressure) should be connected to the low pressure side of the heat source unit. Install the supplied insulation material to the unused drain-socket. When installing insulation material around both water and refrigerant piping, follow the installation manual. The cooling tower and the water circuit must be a closed circuit (water is not exposed to the atmosphere).				

Notes:	Unit converter
1.Nominal cooling conditions (Test conditions are based on AHRI 1230) Indoor: 81°F.D.B./66°F.W.B. (27°C.D.B./19°C.W.B.), Inlet water temperature: 86°F (30°C)	BTU/h =kW x 3,412
2.Nominal heating conditions (Test conditions are based on AHRI 1230) Indoor: 68°F.D.B. (20°C.D.B.), Inlet water temperature: 68°F (20°C)	cfm =m ³ /min x 35.31
	lbs =kg/0.4536
	*Above specification data is subject to rounding variation.

1-2. AHRI 1230-2021 condition

PQRY-P-T(S)LMU-A1, Y(S)LMU-A1

Heat Source Model			PQRY-P72TLMU-A1		
Indoor Model			Non-Ducted	Ducted	
Power source			3-phase 3-wire 208-230 V ±10% 60 Hz		
Cooling capacity (Nominal)	*1	BTU/h	72,000		
		kW	21.1		
	(208-230)	Power input	3.61		
		Current input	11.1-10.0		
	(Rated)	BTU/h	69,000		
		kW	20.2		
	(208-230)	Power input	3.60	3.59	
		Current input	11.1-10.0	11.0-10.0	
	Temp. range of cooling	Indoor	W.B.	59~75°F (15~24°C)	
		Inlet water	°F	50~113°F (10~45°C)	
Heating capacity (Nominal)	*2	BTU/h	80,000		
		kW	23.4		
	(208-230)	Power input	4.04		
		Current input	12.4-11.2		
	(Rated)	BTU/h	76,000		
		kW	22.3		
	(208-230)	Power input	3.78	3.36	
		Current input	11.6-10.5	10.3-9.3	
	Temp. range of heating	Indoor	D.B.	59~81°F (15~27°C)	
		Inlet water	°F	50~113°F (10~45°C)	
Indoor unit connectable	Total capacity	50~150% of heat source unit capacity			
	Model/Quantity	P04-P96/1~18			
Sound pressure level (measured in anechoic room)	dB <A>	46.0			
Refrigerant piping diameter	High pressure	in. (mm)	5/8 (15.88) Brazed		
	Low pressure	in. (mm)	3/4 (19.05) Brazed		
Minimum Circuit Ampacity	A	13-12			
Maximum Overcurrent Protection	A	20-20			
Circulating water	Water flow rate	G/h	1,440		
		G/min	24.0		
		m ³ /h	5.45		
		L/min	91		
		cfm	3.2		
	Pressure drop	psi	3.48		
		kPa	24		
	Operating volume range	G/h	793 ~ 1,902		
		G/min	13.2 ~ 31.7		
		m ³ /h	3.0 ~ 7.2		
Compressor	Type x Quantity	Inverter scroll hermetic compressor x 1			
	Starting method	Inverter			
	Motor output	kW	4.3		
	Case heater	kW	-		
	Lubricant	MEL32			
External finish	Galvanized steel sheets				
External dimension H x W x D	in.	43-5/16 x 34-11/16 x 21-11/16			
	mm	1,100 x 880 x 550			
Protection devices	High pressure protection	High pressure sensor, High pressure switch at 4.15 MPa (601 psi)			
	Inverter circuit	Over-heat protection, Over-current protection			
	Compressor	Over-heat protection			
Refrigerant	Type x original charge	R410A x 11 lbs + 1 oz (5.0 kg)			
	Control	Indoor LEV and BC controller			
Net weight	lbs (kg)	382 (173)			
Heat exchanger	plate type				
	Water volume in plate	G	1.32		
		l	5.0		
	Water pressure Max.	psi	290		
MPa		2.0			
HIC circuit (HIC: Heat Inter-Changer)	-				
Drawing	External	KL94C207			
	Wiring	KE94G422			
Standard attachment	Document	Installation Manual			
	Accessory	Details refer to External Drw			
Optional parts	joint: CMY-Y102SS-G2,CMY-Y102LS-G2,CMY-R160-J1 BC controller: CMB-P104,106,108,1012,1016NU-J1 Main BC controller: CMB-P108,1012,1016NU-JA1,CMB-P1016NU-KA1 Sub BC controller: CMB-P104,108NU-KB1				
Remarks	Details on foundation work, duct work, insulation work, electrical wiring, power source switch, and other items shall be referred to the Installation Manual. Due to continuing improvement, above specifications may be subject to change without notice. The ambient temperature of the Heat Source Unit needs to be kept below 104°F.D.B. (40°C.D.B.) The ambient relative humidity of the Heat Source Unit needs to be kept below 80%. The Heat Source Unit should not be installed at outdoor. Be sure to mount a strainer (more than 50 meshes) at the water inlet piping of the unit. Be sure to provide interlocking for the unit operation and water circuit. Install the supplied insulation material to the unused drain-socket. When installing insulation material around both water and refrigerant piping, follow the installation manual. The cooling tower and the water circuit must be a closed circuit (water is not exposed to the atmosphere).				

Notes:	Unit converter
1.Nominal cooling conditions (Test conditions are based on AHRI 1230) Indoor: 81°F.D.B./66°F.W.B. (27°C.D.B./19°C.W.B.), Inlet water temperature: 86°F (30°C)	BTU/h =kW x 3,412
2.Nominal heating conditions (Test conditions are based on AHRI 1230) Indoor: 68°F.D.B. (20°C.D.B.), Inlet water temperature: 68°F (20°C)	cfm =m ³ /min x 35.31
	lbs =kg/0.4536
	*Above specification data is subject to rounding variation.

1. SPECIFICATIONS

Heat Source Model		PQR-Y-P96TLMU-A1	
Indoor Model		Non-Ducted	Ducted
Power source		3-phase 3-wire 208-230 V ±10% 60 Hz	
Cooling capacity (Nominal)	*1	BTU/h	96,000
		kW	28.1
	Power input	kW	5.21
		A	16.0-14.5
	(Rated)	BTU/h	92,000
		kW	27.0
(208-230)	Power input	kW	5.22
	Current input	A	16.0-14.5
Temp. range of cooling	Indoor	W.B.	59~75°F (15~24°C)
	Inlet water	°F	50~113°F (10~45°C)
Heating capacity (Nominal)	*2	BTU/h	108,000
		kW	31.7
	Power input	kW	5.64
		A	17.3-15.7
	(Rated)	BTU/h	103,000
		kW	30.2
(208-230)	Power input	kW	5.34
	Current input	A	16.4-14.8
Temp. range of heating	Indoor	D.B.	59~81°F (15~27°C)
	Inlet water	°F	50~113°F (10~45°C)
Indoor unit connectable	Total capacity	50~150% of heat source unit capacity	
	Model/Quantity	P04~P96/1~24	
Sound pressure level (measured in anechoic room)	dB <A>	48.0	
Refrigerant piping diameter	High pressure	in. (mm)	3/4 (19.05) Brazed
	Low pressure	in. (mm)	7/8 (22.2) Brazed
Minimum Circuit Ampacity	A	19-17	
Maximum Overcurrent Protection	A	30-25	
Circulating water	Water flow rate	G/h	1,522
		G/min	25.4
		m ³ /h	5.76
		L/min	96
		cfm	3.4
	Pressure drop	psi	3.48
		kPa	24
	Operating volume range	G/h	793 ~ 1,902
G/min		13.2 ~ 31.7	
m ³ /h		3.0 ~ 7.2	
Compressor	Type x Quantity	Inverter scroll hermetic compressor x 1	
	Starting method	Inverter	
	Motor output	kW	6.0
	Case heater	kW	-
	Lubricant	MEL32	
External finish	Galvanized steel sheets		
External dimension H x W x D	in.	43-5/16 x 34-11/16 x 21-11/16	
	mm	1,100 x 880 x 550	
Protection devices	High pressure protection	High pressure sensor, High pressure switch at 4.15 MPa (601 psi)	
	Inverter circuit	Over-heat protection, Over-current protection	
	Compressor	Over-heat protection	
Refrigerant	Type x original charge	R410A x 11 lbs + 1 oz (5.0 kg)	
	Control	Indoor LEV and BC controller	
Net weight	lbs (kg)	382 (173)	
Heat exchanger	Water volume in plate	G	plate type
		l	1.32
	Water pressure Max.	psi	290
		MPa	2.0
HIC circuit (HIC: Heat Inter-Changer)	-		
Drawing	External	KL94C207	
	Wiring	KE94G422	
Standard attachment	Document	Installation Manual	
	Accessory	Details refer to External Drw	
Optional parts	joint: CMY-Y102SS-G2, CMY-Y102LS-G2, CMY-R160-J1 BC controller: CMB-P104, 106, 108, 1012, 1016NU-J1 Main BC controller: CMB-P108, 1012, 1016NU-JA1, CMB-P1016NU-KA1 Sub BC controller: CMB-P104, 108NU-KB1		
Remarks	Details on foundation work, duct work, insulation work, electrical wiring, power source switch, and other items shall be referred to the Installation Manual. Due to continuing improvement, above specifications may be subject to change without notice. The ambient temperature of the Heat Source Unit needs to be kept below 104°F D.B. (40°C D.B.) The ambient relative humidity of the Heat Source Unit needs to be kept below 80%. The Heat Source Unit should not be installed at outdoor. Be sure to mount a strainer (more than 50 meshes) at the water inlet piping of the unit. Be sure to provide interlocking for the unit operation and water circuit. Install the supplied insulation material to the unused drain-socket. When installing insulation material around both water and refrigerant piping, follow the installation manual. The cooling tower and the water circuit must be a closed circuit (water is not exposed to the atmosphere).		

Notes: 1. Nominal cooling conditions (Test conditions are based on AHRI 1230) Indoor: 81°F D.B./66°F W.B. (27°C D.B./19°C W.B.), Inlet water temperature: 86°F (30°C) 2. Nominal heating conditions (Test conditions are based on AHRI 1230) Indoor: 68°F D.B. (20°C D.B.), Inlet water temperature: 68°F (20°C)	Unit converter
	BTU/h = kW x 3,412
	cfm = m ³ /min x 35.31
	lbs = kg/0.4536
*Above specification data is subject to rounding variation.	

1. SPECIFICATIONS

PQRY-P-T(S)LMU-A1, Y(S)LMU-A1

Heat Source Model		PQRY-P120TLMU-A1		
Indoor Model		Non-Ducted	Ducted	
Power source		3-phase 3-wire 208-230 V ±10% 60 Hz		
Cooling capacity (Nominal)	*1	BTU/h	120,000	
		kW	35.2	
	Power input	kW	7.51	
	Current input	A	23.1-20.9	
	(Rated)	BTU/h	115,000	
	(208-230)	kW	33.7	
Temp. range of cooling	Indoor	W.B.	59~75°F (15~24°C)	
	Inlet water	°F	50~113°F (10~45°C)	
	Heating capacity (Nominal)	*2	BTU/h	135,000
			kW	39.6
		Power input	kW	7.09
	Temp. range of heating	(Rated)	BTU/h	129,000
(208-230)		kW	37.8	
Power input		kW	6.61	
Current input		A	20.3-18.4	
Indoor		D.B.	59~81°F (15~27°C)	
Inlet water		°F	50~113°F (10~45°C)	
Indoor unit connectable	Total capacity	50~150% of heat source unit capacity		
	Model/Quantity	P04~P96/1~30		
Sound pressure level (measured in anechoic room)	dB <A>	54.0		
Refrigerant piping diameter	High pressure	in. (mm)	3/4 (19.05) Brazed	
	Low pressure	in. (mm)	7/8 (22.2) Brazed	
Minimum Circuit Ampacity	A	29-26		
Maximum Overcurrent Protection	A	50-45		
Circulating water	Water flow rate	G/h	1,522	
		G/min	25.4	
		m ³ /h	5.76	
		L/min	96	
		cfm	3.4	
	Pressure drop	psi	3.48	
		kPa	24	
	Operating volume range	G/h	793 ~ 1,902	
		G/min	13.2 ~ 31.7	
		m ³ /h	3.0 ~ 7.2	
Compressor	Type x Quantity	Inverter scroll hermetic compressor x 1		
	Starting method	Inverter		
	Motor output	kW	7.7	
	Case heater	kW	-	
	Lubricant	MEL32		
External finish	Galvanized steel sheets			
External dimension H x W x D	in.	43-5/16 x 34-11/16 x 21-11/16		
	mm	1,100 x 880 x 550		
Protection devices	High pressure protection	High pressure sensor, High pressure switch at 4.15 MPa (601 psi)		
	Inverter circuit	Over-heat protection, Over-current protection		
	Compressor	Over-heat protection		
Refrigerant	Type x original charge	R410A x 11 lbs + 1 oz (5.0 kg)		
	Control	Indoor LEV and BC controller		
Net weight	lbs (kg)	382 (173)		
Heat exchanger	Water volume in plate	G	1.32	
		l	5.0	
	Water pressure Max.	psi	290	
		MPa	2.0	
HIC circuit (HIC: Heat Inter-Changer)	-			
Drawing	External	KL94C207		
	Wiring	KE94G422		
Standard attachment	Document	Installation Manual		
	Accessory	Details refer to External Drw		
Optional parts	joint: CMY-Y102SS-G2, CMY-Y102LS-G2, CMY-R160-J1 BC controller: CMB-P104, 106, 108, 1012, 1016NU-J1 Main BC controller: CMB-P108, 1012, 1016NU-JA1, CMB-P1016NU-KA1 Sub BC controller: CMB-P104, 108NU-KB1			
Remarks	Details on foundation work, duct work, insulation work, electrical wiring, power source switch, and other items shall be referred to the Installation Manual. Due to continuing improvement, above specifications may be subject to change without notice. The ambient temperature of the Heat Source Unit needs to be kept below 104°F.D.B. (40°C.D.B.) The ambient relative humidity of the Heat Source Unit needs to be kept below 80%. The Heat Source Unit should not be installed at outdoor. Be sure to mount a strainer (more than 50 meshes) at the water inlet piping of the unit. Be sure to provide interlocking for the unit operation and water circuit. Install the supplied insulation material to the unused drain-socket. When installing insulation material around both water and refrigerant piping, follow the installation manual. The cooling tower and the water circuit must be a closed circuit (water is not exposed to the atmosphere).			

Notes:	Unit converter
1.Nominal cooling conditions (Test conditions are based on AHRI 1230) Indoor: 81°F.D.B./66°F.W.B. (27°C.D.B./19°C.W.B.), Inlet water temperature: 86°F (30°C)	BTU/h =kW x 3,412
2.Nominal heating conditions (Test conditions are based on AHRI 1230) Indoor: 68°F.D.B. (20°C.D.B.), Inlet water temperature: 68°F (20°C)	cfm =m ³ /min x 35.31
	lbs =kg/0.4536
	*Above specification data is subject to rounding variation.

1. SPECIFICATIONS

Heat Source Model		PQRY-P144TLMU-A1	
Indoor Model		Non-Ducted	Ducted
Power source		3-phase 3-wire 208-230 V ±10% 60 Hz	
Cooling capacity (Nominal)	*1	BTU/h	144,000
		kW	42.2
	Power input	kW	8.78
		A	27.0-24.4
	(Rated)	BTU/h	138,000
		kW	40.4
(208-230)	Power input	kW	9.44
	Current input	A	29.1-26.3
Temp. range of cooling	Indoor	W.B.	59~75°F (15~24°C)
	Inlet water	°F	50~113°F (10~45°C)
Heating capacity (Nominal)	*2	BTU/h	160,000
		kW	46.9
	Power input	kW	8.11
		A	25.0-22.6
	(Rated)	BTU/h	152,000
		kW	44.5
(208-230)	Power input	kW	7.43
	Current input	A	22.9-20.7
Temp. range of heating	Indoor	D.B.	59~81°F (15~27°C)
	Inlet water	°F	50~113°F (10~45°C)
Indoor unit connectable	Total capacity	50~150% of heat source unit capacity	
	Model/Quantity	P04~P96/1~36	
Sound pressure level (measured in anechoic room)	dB <A>	54.0	
Refrigerant piping diameter	High pressure	in. (mm)	7/8 (22.2) Brazed
	Low pressure	in. (mm)	1-1/8 (28.58) Brazed
Minimum Circuit Ampacity	A	35-32	
Maximum Overcurrent Protection	A	60-50	
Circulating water	Water flow rate	G/h	1,902
		G/min	31.7
		m ³ /h	7.20
		L/min	120
		cfm	4.2
	Pressure drop	psi	6.38
		kPa	44
	Operating volume range	G/h	1,189 ~ 3,054
		G/min	19.8 ~ 50.9
		m ³ /h	4.5 ~ 11.6
Compressor	Type x Quantity	Inverter scroll hermetic compressor x 1	
	Starting method	Inverter	
	Motor output	kW	9.5
	Case heater	kW	-
	Lubricant	MEL32	
External finish	Galvanized steel sheets		
External dimension H x W x D	in.	57-1/8 x 34-11/16 x 21-11/16	
	mm	1,450 x 880 x 550	
Protection devices	High pressure protection	High pressure sensor, High pressure switch at 4.15 MPa (601 psi)	
	Inverter circuit	Over-heat protection, Over-current protection	
	Compressor	Over-heat protection	
Refrigerant	Type x original charge	R410A x 13 lbs + 4 oz (6.0 kg)	
	Control	Indoor LEV and BC controller	
Net weight	lbs (kg)	481 (218)	
Heat exchanger	Water volume in plate	G	plate type
		l	1.32
	Water pressure Max.	psi	5.0
		MPa	290
HIC circuit (HIC: Heat Inter-Changer)		2.0	
Drawing	External	KL94C208	
	Wiring	KE94G423	
Standard attachment	Document	Installation Manual	
	Accessory	Details refer to External Drw	
Optional parts	joint: CMY-Y102SS-G2,CMY-Y102LS-G2,CMY-R160-J1 Main BC controller: CMB-P108,1012,1016NU-JA1,CMB-P1016NU-KA1 Sub BC controller: CMB-P104,108NU-KB1		
Remarks	Details on foundation work, duct work, insulation work, electrical wiring, power source switch, and other items shall be referred to the Installation Manual. Due to continuing improvement, above specifications may be subject to change without notice. The ambient temperature of the Heat Source Unit needs to be kept below 104°F.D.B. (40°C.D.B.) The ambient relative humidity of the Heat Source Unit needs to be kept below 80%. The Heat Source Unit should not be installed at outdoor. Be sure to mount a strainer (more than 50 meshes) at the water inlet piping of the unit. Be sure to provide interlocking for the unit operation and water circuit. Install the supplied insulation material to the unused drain-socket. When installing insulation material around both water and refrigerant piping, follow the installation manual. The cooling tower and the water circuit must be a closed circuit (water is not exposed to the atmosphere).		

Notes:	Unit converter
1.Nominal cooling conditions (Test conditions are based on AHRI 1230) Indoor: 81°F.D.B./66°F.W.B. (27°C.D.B./19°C.W.B.), Inlet water temperature: 86°F (30°C)	BTU/h =kW x 3,412
2.Nominal heating conditions (Test conditions are based on AHRI 1230) Indoor: 68°F.D.B. (20°C.D.B.), Inlet water temperature: 68°F (20°C)	cfm =m ³ /min x 35.31
	lbs =kg/0.4536
	*Above specification data is subject to rounding variation.

1. SPECIFICATIONS

PQRY-P-T(S)LMU-A1, Y(S)LMU-A1

Heat Source Model		PQRY-P168TLMU-A1		
Indoor Model		Non-Ducted	Ducted	
Power source		3-phase 3-wire 208-230 V ±10% 60 Hz		
Cooling capacity (Nominal)	*1	BTU/h	168,000	
		kW	49.2	
	(208-230)	Power input	kW	
		Current input	A	
	(Rated)	BTU/h	160,000	
		kW	46.9	
(208-230)	Power input	kW		
	Current input	A		
Temp. range of cooling	Indoor	W.B.	59~75°F (15~24°C)	
	Inlet water	°F	50~113°F (10~45°C)	
Heating capacity (Nominal)	*2	BTU/h	188,000	
		kW	55.1	
	(208-230)	Power input	kW	
		Current input	A	
	(Rated)	BTU/h	178,000	
		kW	52.2	
(208-230)	Power input	kW		
	Current input	A		
Temp. range of heating	Indoor	D.B.	59~81°F (15~27°C)	
	Inlet water	°F	50~113°F (10~45°C)	
Indoor unit connectable	Total capacity	50~150% of heat source unit capacity		
	Model/Quantity	P04~P96/1~42		
Sound pressure level (measured in anechoic room)	dB <A>	56.0		
Refrigerant piping diameter	High pressure	in. (mm)	7/8 (22.2) Brazed	
	Low pressure	in. (mm)	1-1/8 (28.58) Brazed	
Minimum Circuit Ampacity	A	44-39		
Maximum Overcurrent Protection	A	70-70		
Circulating water	Water flow rate	G/h	1,902	
		G/min	31.7	
		m ³ /h	7.20	
		L/min	120	
		cfm	4.2	
	Pressure drop	psi	6.38	
		kPa	44	
	Operating volume range	G/h	1,189 ~ 3,054	
G/min		19.8 ~ 50.9		
m ³ /h		4.5 ~ 11.6		
Compressor	Type x Quantity	Inverter scroll hermetic compressor x 1		
	Starting method	Inverter		
	Motor output	kW		
	Case heater	kW		
	Lubricant	MEL32		
External finish	Galvanized steel sheets			
External dimension H x W x D	in.	57-1/8 x 34-11/16 x 21-11/16		
	mm	1,450 x 880 x 550		
Protection devices	High pressure protection	High pressure sensor, High pressure switch at 4.15 MPa (601 psi)		
	Inverter circuit	Over-heat protection, Over-current protection		
	Compressor	Over-heat protection		
Refrigerant	Type x original charge	R410A x 13 lbs + 4 oz (6.0 kg)		
	Control	Indoor LEV and BC controller		
Net weight	lbs (kg)	481 (218)		
Heat exchanger	Water volume in plate	G	plate type	
		L	1.32	
	Water pressure Max.	psi	290	
		MPa	2.0	
HIC circuit (HIC: Heat Inter-Changer)	-			
Drawing	External	KL94C208		
	Wiring	KE94G423		
Standard attachment	Document	Installation Manual		
	Accessory	Details refer to External Drw		
Optional parts	joint: CMY-Y102SS-G2, CMY-Y102LS-G2, CMY-R160-J1 Main BC controller: CMB-P108, 1012, 1016NU-JA1, CMB-P1016NU-KA1 Sub BC controller: CMB-P104, 108NU-KB1			
Remarks	Details on foundation work, duct work, insulation work, electrical wiring, power source switch, and other items shall be referred to the Installation Manual. Due to continuing improvement, above specifications may be subject to change without notice. The ambient temperature of the Heat Source Unit needs to be kept below 104°F.D.B. (40°C.D.B.) The ambient relative humidity of the Heat Source Unit needs to be kept below 80%. The Heat Source Unit should not be installed at outdoor. Be sure to mount a strainer (more than 50 meshes) at the water inlet piping of the unit. Be sure to provide interlocking for the unit operation and water circuit. Install the supplied insulation material to the unused drain-socket. When installing insulation material around both water and refrigerant piping, follow the installation manual. The cooling tower and the water circuit must be a closed circuit (water is not exposed to the atmosphere).			

Notes:	Unit converter
1.Nominal cooling conditions (Test conditions are based on AHRI 1230) Indoor: 81°F.D.B./66°F.W.B. (27°C.D.B./19°C.W.B.), Inlet water temperature: 86°F (30°C)	BTU/h =kW x 3,412
2.Nominal heating conditions (Test conditions are based on AHRI 1230) Indoor: 68°F.D.B. (20°C.D.B.), Inlet water temperature: 68°F (20°C)	cfm =m ³ /min x 35.31
	lbs =kg/0.4536
	*Above specification data is subject to rounding variation.

1. SPECIFICATIONS

Heat Source Model		PQR-Y-P192TLMU-A1		
Indoor Model		Non-Ducted	Ducted	
Power source		3-phase 3-wire 208-230 V ±10% 60 Hz		
Cooling capacity (Nominal)	*1	BTU/h	192,000	
		kW	56.3	
	(208-230)	Power input	kW	15.05
		Current input	A	46.4-41.9
	(Rated)		BTU/h	184,000
			kW	53.9
(208-230)	Power input	kW	15.17	
	Current input	A	46.7-42.3	
Temp. range of cooling	Indoor	W.B.	59~75°F (15~24°C)	
	Inlet water	°F	50~113°F (10~45°C)	
Heating capacity (Nominal)	*2	BTU/h	215,000	
		kW	63.0	
	(208-230)	Power input	kW	11.90
		Current input	A	36.7-33.1
	(Rated)		BTU/h	204,000
			kW	59.8
(208-230)	Power input	kW	10.84	
	Current input	A	33.4-30.2	
Temp. range of heating	Indoor	D.B.	59~81°F (15~27°C)	
	Inlet water	°F	50~113°F (10~45°C)	
Indoor unit connectable	Total capacity	50~150% of heat source unit capacity		
	Model/Quantity	P04~P96/1~48		
Sound pressure level (measured in anechoic room)		dB <A>	58.0	
Refrigerant piping diameter	High pressure	in. (mm)	7/8 (22.2) Brazed	
	Low pressure	in. (mm)	1-1/8 (28.58) Brazed	
Minimum Circuit Ampacity		A	54-49	
Maximum Overcurrent Protection		A	90-80	
Circulating water	Water flow rate	G/h	1,902	
		G/min	31.7	
		m ³ /h	7.20	
		L/min	120	
		cfm	4.2	
	Pressure drop	psi	6.38	
		kPa	44	
	Operating volume range	G/h	1,189 ~ 3,054	
G/min		19.8 ~ 50.9		
m ³ /h		4.5 ~ 11.6		
Compressor	Type x Quantity	Inverter scroll hermetic compressor x 1		
	Starting method	Inverter		
	Motor output	kW	12.4	
	Case heater	kW	-	
	Lubricant	MEL32		
External finish	Galvanized steel sheets			
External dimension H x W x D	in.	57-1/8 x 34-11/16 x 21-11/16		
	mm	1,450 x 880 x 550		
Protection devices	High pressure protection	High pressure sensor, High pressure switch at 4.15 MPa (601 psi)		
	Inverter circuit	Over-heat protection, Over-current protection		
	Compressor	Over-heat protection		
Refrigerant	Type x original charge	R410A x 13 lbs + 4 oz (6.0 kg)		
	Control	Indoor LEV and BC controller		
Net weight	lbs (kg)	481 (218)		
Heat exchanger	plate type			
	Water volume in plate	G	1.32	
		l	5.0	
	Water pressure Max.	psi	290	
MPa		2.0		
HIC circuit (HIC: Heat Inter-Changer)	-			
Drawing	External	KL94C208		
	Wiring	KE94G423		
Standard attachment	Document	Installation Manual		
	Accessory	Details refer to External Drw		
Optional parts	joint: CMY-Y102SS-G2, CMY-Y102LS-G2, CMY-R160-J1 Main BC controller: CMB-P108, 1012, 1016NU-JA1, CMB-P1016NU-KA1 Sub BC controller: CMB-P104, 108NU-KB1			
Remarks	Details on foundation work, duct work, insulation work, electrical wiring, power source switch, and other items shall be referred to the Installation Manual. Due to continuing improvement, above specifications may be subject to change without notice. The ambient temperature of the Heat Source Unit needs to be kept below 104°F.D.B. (40°C.D.B.) The ambient relative humidity of the Heat Source Unit needs to be kept below 80%. The Heat Source Unit should not be installed at outdoor. Be sure to mount a strainer (more than 50 meshes) at the water inlet piping of the unit. Be sure to provide interlocking for the unit operation and water circuit. Install the supplied insulation material to the unused drain-socket. When installing insulation material around both water and refrigerant piping, follow the installation manual. The cooling tower and the water circuit must be a closed circuit (water is not exposed to the atmosphere).			

Notes:	Unit converter
1.Nominal cooling conditions (Test conditions are based on AHRI 1230) Indoor: 81°F.D.B./66°F.W.B. (27°C.D.B./19°C.W.B.), Inlet water temperature: 86°F (30°C)	BTU/h =kW x 3,412
2.Nominal heating conditions (Test conditions are based on AHRI 1230) Indoor: 68°F.D.B. (20°C.D.B.), Inlet water temperature: 68°F (20°C)	cfm =m ³ /min x 35.31
	lbs =kg/0.4536
	*Above specification data is subject to rounding variation.

1. SPECIFICATIONS

WR2-Series

PQRY-P-T(S)LMU-A1, Y(S)LMU-A1

Heat Source Model			PQRY-P216TLMU-A1		
Indoor Model			Non-Ducted	Ducted	
Power source			3-phase 3-wire 208-230 V ±10% 60 Hz		
Cooling capacity (Nominal)	*1	BTU/h	216,000		
		kW	63.3		
	(208-230)	Power input	kW		19.23
		Current input	A		59.3-53.6
	(Rated)	BTU/h	206,000		
		kW	60.4		
	(208-230)	Power input	kW		18.12
		Current input	A		55.8-50.5
Temp. range of cooling	Indoor	W.B.	59~75°F (15~24°C)		
	Inlet water	°F	50~113°F (10~45°C)		
Heating capacity (Nominal)	*2	BTU/h	243,000		
		kW	71.2		
	(208-230)	Power input	kW		13.04
		Current input	A		40.2-36.3
	(Rated)	BTU/h	232,000		
		kW	68.0		
	(208-230)	Power input	kW		11.96
		Current input	A		36.8-33.3
Temp. range of heating	Indoor	D.B.	59~81°F (15~27°C)		
	Inlet water	°F	50~113°F (10~45°C)		
Indoor unit connectable	Total capacity	50~150% of heat source unit capacity			
	Model/Quantity	P04~P96/2~50 (Connectable branch pipe number is max. 48.)			
Sound pressure level (measured in anechoic room)			dB <A>		
Refrigerant piping diameter			58.0		
High pressure			7/8 (22.2) Brazed (1-1/8 (28.58) Brazed for the part that exceeds 65 m)		
Low pressure			1-1/8 (28.58) Brazed		
Minimum Circuit Ampacity			A		
Maximum Overcurrent Protection			A		
Circulating water	Water flow rate	G/h	3,044		
		G/min	50.7		
		m ³ /h	11.52		
		L/min	192		
		cfm	6.8		
	Pressure drop	psi	6.53		
		kPa	45		
	Operating volume range	G/h	1,585 ~ 3,804		
G/min		26.4 ~ 63.4			
m ³ /h		6.0 ~ 14.4			
Compressor	Type x Quantity		Inverter scroll hermetic compressor x 1		
	Starting method		Inverter		
	Motor output	kW	14.5		
	Case heater	kW	0.045		
	Lubricant		MEL32		
External finish			Galvanized steel sheets		
External dimension H x W x D			in.		
			mm		
			57-1/8 x 34-11/16 x 21-11/16		
			1,450 x 880 x 550		
Protection devices	High pressure protection		High pressure sensor, High pressure switch at 4.15 MPa (601 psi)		
	Inverter circuit		Over-heat protection, Over-current protection		
	Compressor		Over-heat protection		
Refrigerant	Type x original charge		R410A x 25 lbs + 13 oz (11.7 kg)		
	Control		Indoor LEV and BC controller		
Net weight			lbs (kg)		
			558 (253)		
Heat exchanger	Water volume in plate		plate type		
	G	2.64			
	l	10.0			
	Water pressure Max.	psi	290		
MPa		2.0			
HIC circuit (HIC: Heat Inter-Changer)					
-					
Drawing	External		KL94C209		
	Wiring		KE94G426		
Standard attachment	Document		Installation Manual		
	Accessory		Details refer to External Drw		
Optional parts			joint: CMY-Y102SS-G2, CMY-Y102LS-G2, CMY-R160-J1		
			Main BC controller: CMB-P108, 1012, 1016NU-JA1, CMB-P1016NU-KA1		
			Sub BC controller: CMB-P104, 108NU-KB1		
Remarks			<p>Details on foundation work, duct work, insulation work, electrical wiring, power source switch, and other items shall be referred to the Installation Manual.</p> <p>Due to continuing improvement, above specifications may be subject to change without notice.</p> <p>The ambient temperature of the Heat Source Unit needs to be kept below 104°F.D.B. (40°C.D.B.)</p> <p>The ambient relative humidity of the Heat Source Unit needs to be kept below 80%.</p> <p>The Heat Source Unit should not be installed at outdoor.</p> <p>Be sure to mount a strainer (more than 50 meshes) at the water inlet piping of the unit.</p> <p>Be sure to provide interlocking for the unit operation and water circuit.</p> <p>Install the supplied insulation material to the unused drain-socket.</p> <p>When installing insulation material around both water and refrigerant piping, follow the installation manual.</p> <p>When the high pressure piping length is 65 m or less, use 7/8 (22.2) pipe. When the high pressure piping length exceeds 65 m, use 1-1/8 (28.58) pipe until 65 m, use 1-1/8 (28.58) pipe for the part that exceeds 65 m.</p> <p>The cooling tower and the water circuit must be a closed circuit (water is not exposed to the atmosphere).</p>		

Notes:	Unit converter
1.Nominal cooling conditions (Test conditions are based on AHRI 1230) Indoor: 81°F.D.B./66°F.W.B. (27°C.D.B./19°C.W.B.), Inlet water temperature: 86°F (30°C)	BTU/h =kW x 3.412
2.Nominal heating conditions (Test conditions are based on AHRI 1230) Indoor: 68°F.D.B. (20°C.D.B.), Inlet water temperature: 68°F (20°C)	cfm =m ³ /min x 35.31
	lbs =kg/0.4536
	*Above specification data is subject to rounding variation.

1. SPECIFICATIONS

Heat Source Model		PQR-P240TLMU-A1		
Indoor Model		Non-Ducted	Ducted	
Power source		3-phase 3-wire 208-230 V ±10% 60 Hz		
Cooling capacity (Nominal)	*1	BTU/h	224,000	
		kW	65.7	
	(208-230)	Power input	kW	21.14
		Current input	A	65.1-58.9
	(Rated)		BTU/h	214,000
			kW	62.7
(208-230)	Power input	kW	18.67	
	Current input	A	57.5-52.0	
Temp. range of cooling	Indoor	W.B.	59~75°F (15~24°C)	
	Inlet water	°F	50~113°F (10~45°C)	
Heating capacity (Nominal)	*2	BTU/h	270,000	
		kW	79.1	
	(208-230)	Power input	kW	15.12
		Current input	A	46.6-42.1
	(Rated)		BTU/h	258,000
			kW	75.6
(208-230)	Power input	kW	13.93	
	Current input	A	42.9-38.8	
Temp. range of heating	Indoor	D.B.	59~81°F (15~27°C)	
	Inlet water	°F	50~113°F (10~45°C)	
Indoor unit connectable	Total capacity	50~150% of heat source unit capacity		
	Model/Quantity	P04~P96/2~50 (Connectable branch pipe number is max. 48.)		
Sound pressure level (measured in anechoic room)		dB <A>		
Refrigerant piping diameter	High pressure	in. (mm)		
	Low pressure	in. (mm)		
Minimum Circuit Ampacity		A		
Maximum Overcurrent Protection		A		
Circulating water	Water flow rate	G/h	3,044	
		G/min	50.7	
		m ³ /h	11.52	
		L/min	192	
		cfm	6.8	
	Pressure drop	psi	6.53	
kPa		45		
Operating volume range	G/h	1,585 ~ 3,804		
	G/min	26.4 ~ 63.4		
	m ³ /h	6.0 ~ 14.4		
Compressor	Type x Quantity		Inverter scroll hermetic compressor x 1	
	Starting method		Inverter	
	Motor output	kW	16.1	
	Case heater	kW	0.045	
	Lubricant		MEL32	
External finish		Galvanized steel sheets		
External dimension H x W x D		in.		
		mm		
Protection devices	High pressure protection	High pressure sensor, High pressure switch at 4.15 MPa (601 psi)		
	Inverter circuit	Over-heat protection, Over-current protection		
	Compressor	Over-heat protection		
Refrigerant	Type x original charge	R410A x 25 lbs + 13 oz (11.7 kg)		
	Control	Indoor LEV and BC controller		
Net weight		lbs (kg)	558 (253)	
Heat exchanger		plate type		
	Water volume in plate	G	2.64	
		l	10.0	
	Water pressure Max.	psi	290	
		MPa	2.0	
HIC circuit (HIC: Heat Inter-Changer)		-		
Drawing	External	KL94C209		
	Wiring	KE94G426		
Standard attachment	Document	Installation Manual		
	Accessory	Details refer to External Drw		
Optional parts		joint: CMY-Y102SS-G2, CMY-Y102LS-G2, CMY-R160-J1 Main BC controller: CMB-P108,1012,1016NU-JA1,CMB-P1016NU-KA1 Sub BC controller: CMB-P104,108NU-KB1		
Remarks		<p>Details on foundation work, duct work, insulation work, electrical wiring, power source switch, and other items shall be referred to the Installation Manual.</p> <p>Due to continuing improvement, above specifications may be subject to change without notice.</p> <p>The ambient temperature of the Heat Source Unit needs to be kept below 104°F D.B. (40°C D.B.)</p> <p>The ambient relative humidity of the Heat Source Unit needs to be kept below 80%.</p> <p>The Heat Source Unit should not be installed at outdoor.</p> <p>Be sure to mount a strainer (more than 50 meshes) at the water inlet piping of the unit.</p> <p>Be sure to provide interlocking for the unit operation and water circuit.</p> <p>Install the supplied insulation material to the unused drain-socket.</p> <p>When installing insulation material around both water and refrigerant piping, follow the installation manual.</p> <p>When the high pressure piping length is 65 m or less, use 7/8 (22.2) pipe. When the high pressure piping length exceeds 65 m, use 1-1/8 (28.58) pipe for the part that exceeds 65 m.</p> <p>The cooling tower and the water circuit must be a closed circuit (water is not exposed to the atmosphere).</p>		

Notes: 1.Nominal cooling conditions (Test conditions are based on AHRI 1230) Indoor: 81°F D.B./66°F W.B. (27°C D.B./19°C W.B.), Inlet water temperature: 86°F (30°C) 2.Nominal heating conditions (Test conditions are based on AHRI 1230) Indoor: 68°F D.B. (20°C D.B.), Inlet water temperature: 68°F (20°C)	Unit converter
	BTU/h =kW x 3,412
	cfm =m ³ /min x 35.31
	lbs =kg/0.4536
	*Above specification data is subject to rounding variation.

1. SPECIFICATIONS

WR2-Series

PQRY-P-T(S)LMU-A1, Y(S)LMU-A1

Heat Source Model			PQRY-P144TSLMU-A1		
Indoor Model			Non-Ducted	Ducted	
Power source			3-phase 3-wire 208-230 V ±10% 60 Hz		
Cooling capacity (Nominal)	(208-230)	*1 BTU/h	144,000		
		kW	42.2		
	Power input	kW		7.11	
	Current input	A		21.9-19.8	
	(Rated)	(208-230)	BTU/h	138,000	
			kW	40.4	
Power input	kW		6.96	8.34	
Current input	A		21.4-19.4	25.7-23.2	
Temp. range of cooling	Indoor	W.B.	59~75°F (15~24°C)		
	Inlet water	°F	50~113°F (10~45°C)		
Heating capacity (Nominal)	(208-230)	*2 BTU/h	160,000		
		kW	46.9		
	Power input	kW		7.45	
	Current input	A		22.9-20.7	
	(Rated)	(208-230)	BTU/h	152,000	
			kW	44.5	
Power input	kW		6.86	7.29	
Current input	A		21.1-19.1	22.4-20.3	
Temp. range of heating	Indoor	D.B.	59~81°F (15~27°C)		
	Inlet water	°F	50~113°F (10~45°C)		
Indoor unit connectable	Total capacity	50~150% of heat source unit capacity			
	Model/Quantity	P04~P96/1~36			
Sound pressure level (measured in anechoic room)			dB <A>		
Refrigerant			49.0		
piping diameter	High pressure	in. (mm)	7/8 (22.2) Brazed		
	Low pressure	in. (mm)	1-1/8 (28.58) Brazed		

Set Model			PQRY-P72TLMU-A1	PQRY-P72TLMU-A1
Model			PQRY-P72TLMU-A1	PQRY-P72TLMU-A1
Minimum Circuit Ampacity			A	13-12
Maximum Overcurrent Protection			A	20-20
Circulating water	Water flow rate	G/h	1,522 + 1,522	
		G/min	25.4 + 25.4	
		m ³ /h	5.76 + 5.76	
		L/min	96 + 96	
		cfm	3.4 + 3.4	
	Pressure drop	psi	3.48	3.48
	kPa	24	24	
Operating volume range	G/h	793 + 793 ~ 1,902 + 1,902		
	G/min	13.2 + 13.2 ~ 31.7 + 31.7		
	m ³ /h	3.0 + 3.0 ~ 7.2 + 7.2		
Compressor	Type x Quantity		Inverter scroll hermetic compressor x 1	
	Starting method		Inverter	
	Motor output	kW	4.3	
	Case heater	kW	-	
	Lubricant		MEL32	
External finish			Galvanized steel sheets	
External dimension H x W x D	in.		43-5/16 x 34-11/16 x 21-11/16	
	mm		1,100 x 880 x 550	
Protection devices	High pressure protection		High pressure sensor, High pressure switch at 4.15 MPa (601 psi)	
	Inverter circuit		Over-heat protection, Over-current protection	
	Compressor		Over-heat protection	
Refrigerant	Type x original charge		R410A x 11 lbs + 1 oz (5.0 kg)	
	Control		Indoor LEV and BC controller	
Net weight		lbs (kg)	382 (173)	
Heat exchanger			plate type	
	Water volume in plate	G	1.32	
		l	5.0	
	Water pressure Max.	psi	290	
MPa		2.0		
HIC circuit (HIC: Heat Inter-Changer)			-	
Pipe between unit and distributor	High pressure	in. (mm)	5/8 (15.88) Brazed	
	Low pressure	in. (mm)	-	
Drawing	External		KL94C219	
	Wiring		KE94G422	
Standard attachment	Document		Installation Manual	
	Accessory		Details refer to External Drw	
Optional parts			Heat Source Twinning kit: CMY-Q100CBK2 joint: CMY-Y102SS-G2, CMY-Y102LS-G2, CMY-R160-J1 Main BC controller: CMB-P108, 1012, 1016NU-JA1, CMB-P1016NU-KA1 Sub BC controller: CMB-P104, 108NU-KB1	
Remarks			<p>Details on foundation work, duct work, insulation work, electrical wiring, power source switch, and other items shall be referred to the Installation Manual.</p> <p>Due to continuing improvement, above specifications may be subject to change without notice.</p> <p>The ambient temperature of the Heat Source Unit needs to be kept below 104°F.D.B. (40°C.D.B.)</p> <p>The ambient relative humidity of the Heat Source Unit needs to be kept below 80%.</p> <p>The Heat Source Unit should not be installed at outdoor.</p> <p>Be sure to mount a strainer (more than 50 meshes) at the water inlet piping of the unit.</p> <p>Be sure to provide interlocking for the unit operation and water circuit.</p> <p>The Heat Source twinning kit (low pressure) should be connected to the low pressure side of the heat source unit.</p> <p>Install the supplied insulation material to the unused drain-socket.</p> <p>When installing insulation material around both water and refrigerant piping, follow the installation manual.</p> <p>The cooling tower and the water circuit must be a closed circuit (water is not exposed to the atmosphere).</p>	

Notes:	Unit converter
1.Nominal cooling conditions (Test conditions are based on AHRI 1230) Indoor: 81°F.D.B./66°F.W.B. (27°C.D.B./19°C.W.B.), Inlet water temperature: 86°F (30°C)	BTU/h =kW x 3.412
2.Nominal heating conditions (Test conditions are based on AHRI 1230) Indoor: 68°F.D.B. (20°C.D.B.), Inlet water temperature: 68°F (20°C)	cfm =m ³ /min x 35.31
	lbs =kg/0.4536
	*Above specification data is subject to rounding variation.

1. SPECIFICATIONS

Heat Source Model		PQR-Y-P168TSLMU-A1		
Indoor Model		Non-Ducted	Ducted	
Power source		3-phase 3-wire 208-230 V ±10% 60 Hz		
Cooling capacity (Nominal)	*1	BTU/h	168,000	
		kW	49.2	
	Power input	kW	9.33	
		A	28.7-26.0	
	(Rated)	(208-230)	BTU/h	160,000
			kW	46.9
Power input	kW	8.87	9.88	
	A	27.3-24.7	30.4-27.5	
Temp. range of cooling	Indoor	W.B.	59~75°F (15~24°C)	
	Inlet water	°F	50~113°F (10~45°C)	
Heating capacity (Nominal)	*2	BTU/h	188,000	
		kW	55.1	
	Power input	kW	9.34	
		A	28.8-26.0	
	(Rated)	(208-230)	BTU/h	178,000
			kW	52.2
Power input	kW	8.53	8.04	
	A	26.3-23.7	24.7-22.4	
Temp. range of heating	Indoor	D.B.	59~81°F (15~27°C)	
	Inlet water	°F	50~113°F (10~45°C)	
Indoor unit connectable	Total capacity	50~150% of heat source unit capacity		
	Model/Quantity	P04~P96/1~42		
Sound pressure level (measured in anechoic room)	dB <A>	50.0		
Refrigerant piping diameter	High pressure	in. (mm)	7/8 (22.2) Braze	
	Low pressure	in. (mm)	1-1/8 (28.58) Braze	

Set Model		PQR-Y-P96TLMU-A1		PQR-Y-P72TLMU-A1	
Minimum Circuit Ampacity		A	19-17	13-12	
Maximum Overcurrent Protection		A	30-25	20-20	
Circulating water	Water flow rate	G/h	1,522 + 1,522		
		G/min	25.4 + 25.4		
		m ³ /h	5.76 + 5.76		
		L/min	96 + 96		
		cfm	3.4 + 3.4		
	Pressure drop	psi	3.48	3.48	
	kPa	24	24		
Operating volume range	G/h	793 + 793 ~ 1,902 + 1,902			
	G/min	13.2 + 13.2 ~ 31.7 + 31.7			
	m ³ /h	3.0 + 3.0 ~ 7.2 + 7.2			
Compressor	Type x Quantity	Inverter scroll hermetic compressor x 1		Inverter scroll hermetic compressor x 1	
	Starting method	Inverter		Inverter	
	Motor output	kW	6.0	4.3	
	Case heater	kW	-	-	
	Lubricant		MEL32	MEL32	
External finish		Galvanized steel sheets		Galvanized steel sheets	
External dimension H x W x D	in.	43-5/16 x 34-11/16 x 21-11/16		43-5/16 x 34-11/16 x 21-11/16	
	mm	1,100 x 880 x 550		1,100 x 880 x 550	
Protection devices	High pressure protection	High pressure sensor, High pressure switch at 4.15 MPa (601 psi)		High pressure sensor, High pressure switch at 4.15 MPa (601 psi)	
	Inverter circuit	Over-heat protection, Over-current protection		Over-heat protection, Over-current protection	
	Compressor	Over-heat protection		Over-heat protection	
Refrigerant	Type x original charge	R410A x 11 lbs + 1 oz (5.0 kg)		R410A x 11 lbs + 1 oz (5.0 kg)	
	Control	Indoor LEV and BC controller			
Net weight	lbs (kg)	382 (173)		382 (173)	
Heat exchanger	Water volume in plate	G	1.32		1.32
		l	5.0		5.0
	Water pressure Max.	psi	290		290
		MPa	2.0		2.0
HIC circuit (HIC: Heat Inter-Changer)		-		-	
Pipe between unit and distributor	High pressure	in. (mm)	3/4 (19.05) Braze		3/4 (19.05) Braze
	Low pressure	in. (mm)	-		7/8 (22.2) Braze
Drawing	External	KL94C219		-	
	Wiring	KE94G422		KE94G422	
Standard attachment	Document	Installation Manual			
	Accessory	Details refer to External Drw			
Optional parts	Heat Source Twinning kit: CMY-Q100CBK2 joint: CMY-Y102SS-G2, CMY-Y102LS-G2, CMY-R160-J1 Main BC controller: CMB-P108, 1012, 1016NU-JA1, CMB-P1016NU-KA1 Sub BC controller: CMB-P104, 108NU-KB1				
Remarks	Details on foundation work, duct work, insulation work, electrical wiring, power source switch, and other items shall be referred to the Installation Manual. Due to continuing improvement, above specifications may be subject to change without notice. The ambient temperature of the Heat Source Unit needs to be kept below 104°F.D.B. (40°C.D.B.) The ambient relative humidity of the Heat Source Unit needs to be kept below 80%. The Heat Source Unit should not be installed at outdoor. Be sure to mount a strainer (more than 50 meshes) at the water inlet piping of the unit. Be sure to provide interlocking for the unit operation and water circuit. The Heat Source twinning kit (low pressure) should be connected to the low pressure side of the heat source unit. Install the supplied insulation material to the unused drain-socket. When installing insulation material around both water and refrigerant piping, follow the installation manual. The cooling tower and the water circuit must be a closed circuit (water is not exposed to the atmosphere).				

Notes:	Unit converter
1.Nominal cooling conditions (Test conditions are based on AHRI 1230) Indoor: 81°F.D.B./66°F.W.B. (27°C.D.B./19°C.W.B.), Inlet water temperature: 86°F (30°C)	BTU/h =kW x 3,412
2.Nominal heating conditions (Test conditions are based on AHRI 1230) Indoor: 68°F.D.B. (20°C.D.B.), Inlet water temperature: 68°F (20°C)	cfm =m ³ /min x 35.31
	lbs =kg/0.4536
	*Above specification data is subject to rounding variation.

1. SPECIFICATIONS

WR2-Series

PQRY-P-T(S)LMU-A1, Y(S)LMU-A1

Heat Source Model			PQRY-P192TSLMU-A1		
Indoor Model			Non-Ducted	Ducted	
Power source			3-phase 3-wire 208-230 V ±10% 60 Hz		
Cooling capacity (Nominal)	*1	BTU/h	192,000		
		kW	56.3		
	(208-230)	Power input	kW	11.30	
		Current input	A	34.8-31.5	
	(Rated)	BTU/h	184,000		
		kW	53.9		
	(208-230)	Power input	kW	10.84	11.80
		Current input	A	33.4-30.2	36.3-32.9
Temp. range of cooling	Indoor	W.B.	59~75°F (15~24°C)		
	Inlet water	°F	50~113°F (10~45°C)		
Heating capacity (Nominal)	*2	BTU/h	215,000		
		kW	63.0		
	(208-230)	Power input	kW	11.02	
		Current input	A	33.9-30.7	
	(Rated)	BTU/h	204,000		
		kW	59.8		
	(208-230)	Power input	kW	10.09	8.93
		Current input	A	31.1-28.1	27.5-24.9
Temp. range of heating	Indoor	D.B.	59~81°F (15~27°C)		
	Inlet water	°F	50~113°F (10~45°C)		
Indoor unit connectable	Total capacity	50~150% of heat source unit capacity			
	Model/Quantity	P04-P96/1-48			
Sound pressure level (measured in anechoic room)	dB <A>	51.0			
Refrigerant piping diameter	High pressure	in. (mm)	7/8 (22.2) Brazed		
	Low pressure	in. (mm)	1-1/8 (28.58) Brazed		

Set Model			PQRY-P96TLMU-A1	PQRY-P96TLMU-A1	
Model			PQRY-P96TLMU-A1	PQRY-P96TLMU-A1	
Minimum Circuit Ampacity			A	19-17	
Maximum Overcurrent Protection			A	30-25	
Circulating water	Water flow rate	G/h	1,522 + 1,522		
		G/min	25.4 + 25.4		
		m ³ /h	5.76 + 5.76		
		L/min	96 + 96		
		cfm	3.4 + 3.4		
	Pressure drop	psi	3.48	3.48	
		kPa	24	24	
Operating volume range	G/h	793 + 793 ~ 1,902 + 1,902			
	G/min	13.2 + 13.2 ~ 31.7 + 31.7			
	m ³ /h	3.0 + 3.0 ~ 7.2 + 7.2			
Compressor	Type x Quantity	Inverter scroll hermetic compressor x 1		Inverter scroll hermetic compressor x 1	
	Starting method	Inverter		Inverter	
	Motor output	kW	6.0	6.0	
	Case heater	kW	-	-	
	Lubricant		MEL32	MEL32	
External finish			Galvanized steel sheets	Galvanized steel sheets	
External dimension H x W x D	in.	43-5/16 x 34-11/16 x 21-11/16		43-5/16 x 34-11/16 x 21-11/16	
	mm	1,100 x 880 x 550		1,100 x 880 x 550	
Protection devices	High pressure protection	High pressure sensor, High pressure switch at 4.15 MPa (601 psi)	High pressure sensor, High pressure switch at 4.15 MPa (601 psi)		
	Inverter circuit	Over-heat protection, Over-current protection		Over-heat protection, Over-current protection	
	Compressor	Over-heat protection		Over-heat protection	
Refrigerant	Type x original charge	R410A x 11 lbs + 1 oz (5.0 kg)		R410A x 11 lbs + 1 oz (5.0 kg)	
	Control	Indoor LEV and BC controller			
Net weight	lbs (kg)	382 (173)		382 (173)	
Heat exchanger	Water volume in plate	plate type	plate type		
		G	1.32		
	I	5.0			
	Water pressure Max.	psi	290		
MPa		2.0			
HIC circuit (HIC: Heat Inter-Changer)			-	-	
Pipe between unit and distributor	High pressure	in. (mm)	3/4 (19.05) Brazed		
	Low pressure	in. (mm)	-		
Drawing	External	KL94C219			
	Wiring	KE94G422	KE94G422		
Standard attachment	Document	Installation Manual			
	Accessory	Details refer to External Drw			
Optional parts	Heat Source Twinning kit: CMY-Q100CBK2 joint: CMY-Y102SS-G2, CMY-Y102LS-G2, CMY-R160-J1 Main BC controller: CMB-P108, 1012, 1016NU-JA1, CMB-P1016NU-KA1 Sub BC controller: CMB-P104, 108NU-KB1				

Remarks

Details on foundation work, duct work, insulation work, electrical wiring, power source switch, and other items shall be referred to the Installation Manual.

Due to continuing improvement, above specifications may be subject to change without notice.

The ambient temperature of the Heat Source Unit needs to be kept below 104°F.D.B. (40°C.D.B.)

The ambient relative humidity of the Heat Source Unit needs to be kept below 80%.

The Heat Source Unit should not be installed at outdoor.

Be sure to mount a strainer (more than 50 meshes) at the water inlet piping of the unit.

Be sure to provide interlocking for the unit operation and water circuit.

The Heat Source twinning kit (low pressure) should be connected to the low pressure side of the heat source unit.

Install the supplied insulation material to the unused drain-socket.

When installing insulation material around both water and refrigerant piping, follow the installation manual.

The cooling tower and the water circuit must be a closed circuit (water is not exposed to the atmosphere).

Notes:	Unit converter
1.Nominal cooling conditions (Test conditions are based on AHRI 1230) Indoor: 81°F.D.B./66°F.W.B. (27°C.D.B./19°C.W.B.), Inlet water temperature: 86°F (30°C)	BTU/h =kW x 3,412
2.Nominal heating conditions (Test conditions are based on AHRI 1230) Indoor: 68°F.D.B. (20°C.D.B.), Inlet water temperature: 68°F (20°C)	cfm =m ³ /min x 35.31
	lbs =kg/0.4536
	*Above specification data is subject to rounding variation.

1. SPECIFICATIONS

Heat Source Model		PQRY-P216TSLMU-A1		
Indoor Model		Non-Ducted	Ducted	
Power source		3-phase 3-wire 208-230 V ±10% 60 Hz		
Cooling capacity (Nominal)	*1	BTU/h	216,000	
		kW	63.3	
	(208-230)	Power input	14.03	
		Current input	43.2-39.1	
	(Rated)		BTU/h	206,000
			kW	60.4
(208-230)	Power input	13.27	14.31	
	Current input	40.9-37.0	44.1-39.9	
Temp. range of cooling	Indoor	W.B.	59~75°F (15~24°C)	
	Inlet water	°F	50~113°F (10~45°C)	
Heating capacity (Nominal)	*2	BTU/h	243,000	
		kW	71.2	
	(208-230)	Power input	12.88	
		Current input	39.7-35.9	
	(Rated)		BTU/h	232,000
			kW	68.0
(208-230)	Power input	11.78	10.04	
	Current input	36.3-32.8	30.9-28.0	
Temp. range of heating	Indoor	D.B.	59~81°F (15~27°C)	
	Inlet water	°F	50~113°F (10~45°C)	
Indoor unit connectable	Total capacity	50~150% of heat source unit capacity		
	Model/Quantity	P04~P96/2~50 (Connectable branch pipe number is max. 48.)		
Sound pressure level (measured in anechoic room)	dB <A>	55.0		
Refrigerant piping diameter	High pressure	7/8 (22.2) Brazed (1-1/8 (28.58) Brazed for the part that exceeds 65 m)		
	Low pressure	1-1/8 (28.58) Brazed		

Set Model		PQRY-P120TLMU-A1		PQRY-P96TLMU-A1	
Minimum Circuit Ampacity		A	29-26	19-17	
Maximum Overcurrent Protection		A	50-45	30-25	
Circulating water	Water flow rate	G/h	1,522 + 1,522		
		G/min	25.4 + 25.4		
		m ³ /h	5.76 + 5.76		
		L/min	96 + 96		
		cfm	3.4 + 3.4		
	Pressure drop	psi	3.48	3.48	
	kPa	24	24		
Operating volume range	G/h	793 + 793 ~ 1,902 + 1,902			
	G/min	13.2 + 13.2 ~ 31.7 + 31.7			
	m ³ /h	3.0 + 3.0 ~ 7.2 + 7.2			
Compressor	Type x Quantity	Inverter scroll hermetic compressor x 1		Inverter scroll hermetic compressor x 1	
	Starting method	Inverter		Inverter	
	Motor output	kW	7.7	6.0	
	Case heater	kW	-	-	
	Lubricant		MEL32	MEL32	
External finish		Galvanized steel sheets		Galvanized steel sheets	
External dimension H x W x D	in.	43-5/16 x 34-11/16 x 21-11/16		43-5/16 x 34-11/16 x 21-11/16	
	mm	1,100 x 880 x 550		1,100 x 880 x 550	
Protection devices	High pressure protection	High pressure sensor, High pressure switch at 4.15 MPa (601 psi)		High pressure sensor, High pressure switch at 4.15 MPa (601 psi)	
	Inverter circuit	Over-heat protection, Over-current protection		Over-heat protection, Over-current protection	
	Compressor	Over-heat protection		Over-heat protection	
Refrigerant	Type x original charge	R410A x 11 lbs + 1 oz (5.0 kg)		R410A x 11 lbs + 1 oz (5.0 kg)	
	Control	Indoor LEV and BC controller			
Net weight	lbs (kg)	382 (173)		382 (173)	
Heat exchanger	Water volume in plate	plate type	plate type		
		G	1.32		
	l	5.0			
	Water pressure Max.	psi	290		
MPa		2.0			
HIC circuit (HIC: Heat Inter-Changer)		-		-	
Pipe between unit and distributor	High pressure	in. (mm)	3/4 (19.05) Brazed		
	Low pressure	in. (mm)	-		
Drawing	External	KL94C219			
	Wiring	KE94G422	KE94G422		
Standard attachment	Document	Installation Manual			
	Accessory	Details refer to External Drw			
Optional parts	Heat Source Twinning kit: CMY-Q100CBK2 joint: CMY-Y102SS-G2, CMY-Y102LS-G2, CMY-R160-J1 Main BC controller: CMB-P108, 1012, 1016NU-JA1, CMB-P1016NU-KA1 Sub BC controller: CMB-P104, 108NU-KB1				
Remarks	Details on foundation work, duct work, insulation work, electrical wiring, power source switch, and other items shall be referred to the Installation Manual. Due to continuing improvement, above specifications may be subject to change without notice. The ambient temperature of the Heat Source Unit needs to be kept below 104°F.D.B. (40°C.D.B.) The ambient relative humidity of the Heat Source Unit needs to be kept below 80%. The Heat Source Unit should not be installed at outdoor. Be sure to mount a strainer (more than 50 meshes) at the water inlet piping of the unit. Be sure to provide interlocking for the unit operation and water circuit. The Heat Source twinning kit (low pressure) should be connected to the low pressure side of the heat source unit. Install the supplied insulation material to the unused drain-socket. When installing insulation material around both water and refrigerant piping, follow the installation manual. When the high pressure piping length is 65 m or less, use 7/8 (22.2) pipe. When the high pressure piping length exceeds 65 m, use 1-1/8 (28.58) pipe until 65 m, use 1-1/8 (28.58) pipe for the part that exceeds 65 m. The cooling tower and the water circuit must be a closed circuit (water is not exposed to the atmosphere).				

Notes:	Unit converter
1. Nominal cooling conditions (Test conditions are based on AHRI 1230) Indoor: 81°F.D.B./66°F.W.B. (27°C.D.B./19°C.W.B.), Inlet water temperature: 86°F (30°C)	BTU/h =kW x 3,412
2. Nominal heating conditions (Test conditions are based on AHRI 1230) Indoor: 68°F.D.B. (20°C.D.B.), Inlet water temperature: 68°F (20°C)	cfm =m ³ /min x 35.31
	lbs =kg/0.4536
	*Above specification data is subject to rounding variation.

1. SPECIFICATIONS

WR2-Series

PQRY-P-T(S)LMU-A1, Y(S)LMU-A1

Heat Source Model			PQRY-P240TSLMU-A1		
Indoor Model			Non-Ducted	Ducted	
Power source			3-phase 3-wire 208-230 V ±10% 60 Hz		
Cooling capacity (Nominal)	*1	BTU/h	240,000		
		kW	70.3		
	(208-230) (Rated)	Power input	kW	16.89	
		Current input	A	52.0-47.1	
		BTU/h	230,000		
			kW	67.4	
(208-230)	Power input	kW	16.08	17.37	
	Current input	A	49.5-44.8	53.5-48.4	
Temp. range of cooling	Indoor	W.B.	59~75°F (15~24°C)		
	Inlet water	°F	50~113°F (10~45°C)		
Heating capacity (Nominal)	*2	BTU/h	270,000		
		kW	79.1		
	(208-230) (Rated)	Power input	kW	14.58	
		Current input	A	44.9-40.6	
		BTU/h	258,000		
			kW	75.6	
(208-230)	Power input	kW	13.40	11.67	
	Current input	A	41.3-37.3	35.9-32.5	
Temp. range of heating	Indoor	D.B.	59~81°F (15~27°C)		
	Inlet water	°F	50~113°F (10~45°C)		
Indoor unit connectable			50~150% of heat source unit capacity		
Model/Quantity			P04~P96/2~50 (Connectable branch pipe number is max. 48.)		
Sound pressure level (measured in anechoic room)			dB <A> 57.0		
Refrigerant piping diameter			High pressure in. (mm) 7/8 (22.2) Brazed (1-1/8 (28.58) Brazed for the part that exceeds 65 m)		
			Low pressure in. (mm) 1-3/8 (34.93) Brazed		

Set Model			PQRY-P120TLMU-A1	
Model			PQRY-P120TLMU-A1	
Minimum Circuit Ampacity			A 29-26	
Maximum Overcurrent Protection			A 50-45	
Circulating water	Water flow rate	G/h	1,522 + 1,522	
		G/min	25.4 + 25.4	
		m ³ /h	5.76 + 5.76	
		L/min	96 + 96	
		cfm	3.4 + 3.4	
	Pressure drop	psi	3.48	3.48
	kPa	24	24	
Operating volume range	G/h	793 + 793 ~ 1,902 + 1,902		
	G/min	13.2 + 13.2 ~ 31.7 + 31.7		
	m ³ /h	3.0 + 3.0 ~ 7.2 + 7.2		
Compressor	Type x Quantity		Inverter scroll hermetic compressor x 1	
	Starting method		Inverter	
	Motor output	kW	7.7	
	Case heater	kW	-	
	Lubricant		MEL32	
External finish			Galvanized steel sheets	
External dimension H x W x D			in. 43-5/16 x 34-11/16 x 21-11/16	
			mm 1,100 x 880 x 550	
Protection devices	High pressure protection		High pressure sensor, High pressure switch at 4.15 MPa (601 psi)	
	Inverter circuit		Over-heat protection, Over-current protection	
	Compressor		Over-heat protection	
Refrigerant	Type x original charge		R410A x 11 lbs + 1 oz (5.0 kg)	
	Control		Indoor LEV and BC controller	
Net weight			lbs (kg) 382 (173)	
Heat exchanger	plate type		plate type	
	Water volume in plate	G	1.32	
		l	5.0	
	Water pressure Max.	psi	290	
MPa		2.0		
HIC circuit (HIC: Heat Inter-Changer)			-	
Pipe between unit and distributor	High pressure in. (mm)		3/4 (19.05) Brazed	
	Low pressure in. (mm)		7/8 (22.2) Brazed	
Drawing	External		KL94C219	
	Wiring		KE94G422	
Standard attachment	Document		Installation Manual	
	Accessory		Details refer to External Drw	
Optional parts			Heat Source Twinning kit: CMY-Q100CBK2 joint: CMY-Y102SS-G2, CMY-Y102LS-G2, CMY-R160-J1 Main BC controller: CMB-P108, 1012, 1016NU-JA1, CMB-P1016NU-KA1 Sub BC controller: CMB-P104, 108NU-KB1	
Remarks			<p>Details on foundation work, duct work, insulation work, electrical wiring, power source switch, and other items shall be referred to the Installation Manual.</p> <p>Due to continuing improvement, above specifications may be subject to change without notice.</p> <p>The ambient temperature of the Heat Source Unit needs to be kept below 104°F D.B. (40°C D.B.)</p> <p>The ambient relative humidity of the Heat Source Unit needs to be kept below 80%.</p> <p>The Heat Source Unit should not be installed at outdoor.</p> <p>Be sure to mount a strainer (more than 50 meshes) at the water inlet piping of the unit.</p> <p>Be sure to provide interlocking for the unit operation and water circuit.</p> <p>The Heat Source twinning kit (low pressure) should be connected to the low pressure side of the heat source unit.</p> <p>Install the supplied insulation material to the unused drain-socket.</p> <p>When installing insulation material around both water and refrigerant piping, follow the installation manual.</p> <p>When the high pressure piping length is 65 m or less, use 7/8 (22.2) pipe. When the high pressure piping length exceeds 65 m, use 1-1/8 (28.58) pipe until 65 m, use 1-1/8 (28.58) pipe for the part that exceeds 65 m.</p> <p>The cooling tower and the water circuit must be a closed circuit (water is not exposed to the atmosphere).</p>	

Notes:	1. Nominal cooling conditions (Test conditions are based on AHRI 1230) Indoor: 81°F D.B./66°F W.B. (27°C D.B./19°C W.B.), Inlet water temperature: 86°F (30°C)	Unit converter BTU/h =kW x 3.412 cfm =m ³ /min x 35.31 lbs =kg/0.4536 *Above specification data is subject to rounding variation.
	2. Nominal heating conditions (Test conditions are based on AHRI 1230) Indoor: 68°F D.B. (20°C D.B.), Inlet water temperature: 68°F (20°C)	

1. SPECIFICATIONS

PQRY-P-T(S)LMU-A1, Y(S)LMU-A1

Heat Source Model		PQRY-P288TSLMU-A1		
Indoor Model		Non-Ducted	Ducted	
Power source		3-phase 3-wire 208-230 V ±10% 60 Hz		
Cooling capacity (Nominal)	*1	BTU/h	288,000	
		kW	84.4	
	(208-230)	Power input	kW	20.42
		Current input	A	62.9-56.9
	(Rated)		BTU/h	276,000
			kW	80.9
(208-230)	Power input	kW	20.11	
	Current input	A	62.0-56.0	
Temp. range of cooling	Indoor	W.B.	59~75°F (15~24°C)	
	Inlet water	°F	50~113°F (10~45°C)	
Heating capacity (Nominal)	*2	BTU/h	304,000	
		kW	89.1	
	(208-230)	Power input	kW	17.50
		Current input	A	53.9-48.8
	(Rated)		BTU/h	304,000
			kW	89.1
(208-230)	Power input	kW	15.83	
	Current input	A	48.8-44.1	
Temp. range of heating	Indoor	D.B.	59~81°F (15~27°C)	
	Inlet water	°F	50~113°F (10~45°C)	
Indoor unit connectable	Total capacity	50~150% of heat source unit capacity		
	Model/Quantity	P04~P96/2~50 (Connectable branch pipe number is max. 48.)		
Sound pressure level (measured in anechoic room)	dB <A>	57.0		
Refrigerant piping diameter	High pressure	in. (mm)	1-1/8 (28.58) Brazed	
	Low pressure	in. (mm)	1-3/8 (34.93) Brazed	

Set Model		PQRY-P144TLMU-A1		PQRY-P144TLMU-A1	
Minimum Circuit Ampacity		A	35-32	35-32	
Maximum Overcurrent Protection		A	60-50	60-50	
Circulating water	Water flow rate	G/h	1,902 + 1,902		
		G/min	31.7 + 31.7		
		m ³ /h	7.20 + 7.20		
		L/min	120 + 120		
		cfm	4.2 + 4.2		
	Pressure drop	psi	6.38	6.38	
	kPa	44	44		
Operating volume range	G/h	1,189 + 1,189 ~ 3,054 + 3,054			
	G/min	19.8 + 19.8 ~ 50.9 + 50.9			
	m ³ /h	4.5 + 4.5 ~ 11.6 + 11.6			
Compressor	Type x Quantity	Inverter scroll hermetic compressor x 1		Inverter scroll hermetic compressor x 1	
	Starting method	Inverter		Inverter	
	Motor output	kW	9.5	9.5	
	Case heater	kW	-	-	
	Lubricant		MEL32	MEL32	
External finish		Galvanized steel sheets		Galvanized steel sheets	
External dimension H x W x D	in.	57-1/8 x 34-11/16 x 21-11/16		57-1/8 x 34-11/16 x 21-11/16	
	mm	1,450 x 880 x 550		1,450 x 880 x 550	
Protection devices	High pressure protection	High pressure sensor, High pressure switch at 4.15 MPa (601 psi)		High pressure sensor, High pressure switch at 4.15 MPa (601 psi)	
	Inverter circuit	Over-heat protection, Over-current protection		Over-heat protection, Over-current protection	
	Compressor	Over-heat protection		Over-heat protection	
Refrigerant	Type x original charge	R410A x 13 lbs + 4 oz (6.0 kg)		R410A x 13 lbs + 4 oz (6.0 kg)	
	Control	Indoor LEV and BC controller			
Net weight	lbs (kg)	481 (218)		481 (218)	
Heat exchanger	Water volume in plate	plate type	plate type		
		G	1.32		
	l	5.0			
	Water pressure Max.	psi	290		
MPa		2.0			
HIC circuit (HIC: Heat Inter-Changer)		-		-	
Pipe between unit and distributor	High pressure	in. (mm)	7/8 (22.2) Brazed		
	Low pressure	in. (mm)	-		
Drawing	External	KL94C220		KL94C220	
	Wiring	KE94G423		KE94G423	
Standard attachment	Document	Installation Manual			
	Accessory	Details refer to External Drw			
Optional parts	Heat Source Twinning kit: CMY-Q200CBK joint: CMY-Y102SS-G2, CMY-Y102LS-G2, CMY-R160-J1 Main BC controller: CMB-P108, 1012, 1016NU-JA1, CMB-P1016NU-KA1 Sub BC controller: CMB-P104, 108NU-KB1				
Remarks	Details on foundation work, duct work, insulation work, electrical wiring, power source switch, and other items shall be referred to the Installation Manual. Due to continuing improvement, above specifications may be subject to change without notice. The ambient temperature of the Heat Source Unit needs to be kept below 104°F (40°C). The ambient relative humidity of the Heat Source Unit needs to be kept below 80%. The Heat Source Unit should not be installed at outdoor. Be sure to mount a strainer (more than 50 meshes) at the water inlet piping of the unit. Be sure to provide interlocking for the unit operation and water circuit. The Heat Source twinning kit (low pressure) should be connected to the low pressure side of the heat source unit. Install the supplied insulation material to the unused drain-socket. When installing insulation material around both water and refrigerant piping, follow the installation manual. The cooling tower and the water circuit must be a closed circuit (water is not exposed to the atmosphere).				

Notes:	Unit converter
1. Nominal cooling conditions (Test conditions are based on AHRI 1230) Indoor: 81°F D.B./66°F W.B. (27°C D.B./19°C W.B.), Inlet water temperature: 86°F (30°C)	BTU/h = kW x 3,412
2. Nominal heating conditions (Test conditions are based on AHRI 1230) Indoor: 68°F D.B. (20°C D.B.), Inlet water temperature: 68°F (20°C)	cfm = m ³ /min x 35.31
	lbs = kg/0.4536
	*Above specification data is subject to rounding variation.

1. SPECIFICATIONS

WR2-Series

PQRY-P-T(S)LMU-A1, Y(S)LMU-A1

Heat Source Model			PQRY-P312TSLMU-A1		
Indoor Model			Non-Ducted	Ducted	
Power source			3-phase 3-wire 208-230 V ±10% 60 Hz		
Cooling capacity (Nominal)	*1	BTU/h	312,000		
		kW	91.4		
		Power input kW	23.41		
		Current input A	72.1-65.2		
		(208-230) (Rated) BTU/h	298,000		
		kW	87.3		
(208-230)	(Rated)	Power input kW	22.45	24.98	
		Current input A	69.2-62.6	77.0-69.6	
		Temp. range of cooling Indoor	W.B. 59~75°F (15~24°C)		
		Inlet water	°F 50~113°F (10~45°C)		
Heating capacity (Nominal)	*2	BTU/h	350,000		
		kW	102.6		
		Power input kW	19.11		
		Current input A	58.9-53.3		
		(208-230) (Rated) BTU/h	334,000		
		kW	97.9		
(208-230)	(Rated)	Power input kW	17.48	17.49	
		Current input A	53.9-48.7	53.9-48.7	
Temp. range of heating	Indoor	D.B. 59~81°F (15~27°C)			
		°F 50~113°F (10~45°C)			
Heating capacity (Nominal)	*2	50~150% of heat source unit capacity			
		Model/Quantity P04~P96/2~50 (Connectable branch pipe number is max. 48.)			
Indoor unit connectable	Total capacity	50~150% of heat source unit capacity			
Sound pressure level (measured in anechoic room)	dB <A>	58.0			
Refrigerant piping diameter	High pressure	in. (mm) 1-1/8 (28.58) Brazed			
	Low pressure	in. (mm) 1-3/8 (34.93) Brazed			

Set Model			PQRY-P168TLMU-A1		PQRY-P144TLMU-A1	
Model			PQRY-P168TLMU-A1		PQRY-P144TLMU-A1	
Minimum Circuit Ampacity			A 44-39		35-32	
Maximum Overcurrent Protection			A 70-70		60-50	
Circulating water	Water flow rate	G/h	1,902 + 1,902			
		G/min	31.7 + 31.7			
		m ³ /h	7.20 + 7.20			
		L/min	120 + 120			
		cfm	4.2 + 4.2			
		Pressure drop	psi	6.38		6.38
	kPa	44		44		
Operating volume range	G/h	1,189 + 1,189 ~ 3,054 + 3,054				
		19.8 + 19.8 ~ 50.9 + 50.9				
		G/min	4.5 + 4.5 ~ 11.6 + 11.6			
			m ³ /h			
Compressor	Type x Quantity	Inverter scroll hermetic compressor x 1		Inverter scroll hermetic compressor x 1		
	Starting method	Inverter		Inverter		
	Motor output kW	11.0		9.5		
	Case heater kW	-		-		
	Lubricant	MEL32		MEL32		
External finish			Galvanized steel sheets		Galvanized steel sheets	
External dimension H x W x D			in. 57-1/8 x 34-11/16 x 21-11/16		57-1/8 x 34-11/16 x 21-11/16	
	mm 1,450 x 880 x 550		1,450 x 880 x 550		1,450 x 880 x 550	
Protection devices	High pressure protection		High pressure sensor, High pressure switch at 4.15 MPa (601 psi)		High pressure sensor, High pressure switch at 4.15 MPa (601 psi)	
	Inverter circuit		Over-heat protection, Over-current protection		Over-heat protection, Over-current protection	
	Compressor		Over-heat protection		Over-heat protection	
Refrigerant	Type x original charge		R410A x 13 lbs + 4 oz (6.0 kg)		R410A x 13 lbs + 4 oz (6.0 kg)	
	Control		Indoor LEV and BC controller			
Net weight			lbs (kg) 481 (218)		481 (218)	
Heat exchanger	plate type		plate type		plate type	
	Water volume in plate	G	1.32		1.32	
		l	5.0		5.0	
	Water pressure Max.	psi	290		290	
MPa		2.0		2.0		
HIC circuit (HIC: Heat Inter-Changer)			-		-	
Pipe between unit and distributor	High pressure		in. (mm) 7/8 (22.2) Brazed		7/8 (22.2) Brazed	
	Low pressure		in. (mm) -		1-1/8 (28.58) Brazed	
Drawing	External		KL94C220			
	Wiring		KE94G423		KE94G423	
Standard attachment	Document		Installation Manual			
	Accessory		Details refer to External Drw			
Optional parts			Heat Source Twinning kit: CMY-Q200CBK joint: CMY-Y102SS-G2, CMY-Y102LS-G2, CMY-R160-J1 Main BC controller: CMB-P108, 1012, 1016NU-JA1, CMB-P1016NU-KA1 Sub BC controller: CMB-P104, 108NU-KB1			
Remarks			<p>Details on foundation work, duct work, insulation work, electrical wiring, power source switch, and other items shall be referred to the Installation Manual.</p> <p>Due to continuing improvement, above specifications may be subject to change without notice.</p> <p>The ambient temperature of the Heat Source Unit needs to be kept below 104°F.D.B. (40°C.D.B.)</p> <p>The ambient relative humidity of the Heat Source Unit needs to be kept below 80%.</p> <p>The Heat Source Unit should not be installed at outdoor.</p> <p>Be sure to mount a strainer (more than 50 meshes) at the water inlet piping of the unit.</p> <p>Be sure to provide interlocking for the unit operation and water circuit.</p> <p>The Heat Source twinning kit (low pressure) should be connected to the low pressure side of the heat source unit.</p> <p>Install the supplied insulation material to the unused drain-socket.</p> <p>When installing insulation material around both water and refrigerant piping, follow the installation manual.</p> <p>The cooling tower and the water circuit must be a closed circuit (water is not exposed to the atmosphere).</p>			

Notes:	Unit converter
1. Nominal cooling conditions (Test conditions are based on AHRI 1230) Indoor: 81°F.D.B./66°F.W.B. (27°C.D.B./19°C.W.B.), Inlet water temperature: 86°F (30°C)	BTU/h =kW x 3,412
2. Nominal heating conditions (Test conditions are based on AHRI 1230) Indoor: 68°F.D.B. (20°C.D.B.), Inlet water temperature: 68°F (20°C)	cfm =m ³ /min x 35.31
	lbs =kg/0.4536
	*Above specification data is subject to rounding variation.

1. SPECIFICATIONS

Heat Source Model		PQR-Y-P336TSLMU-A1		
Indoor Model		Non-Ducted	Ducted	
Power source		3-phase 3-wire 208-230 V ±10% 60 Hz		
Cooling capacity (Nominal)	*1	BTU/h	336,000	
		kW	98.5	
	(208-230)	Power input	kW	26.84
		Current input	A	82.7-74.8
	(Rated)		BTU/h	320,000
			kW	93.8
(208-230)	Power input	kW	25.14	
	Current input	A	77.5-70.1	
Temp. range of cooling	Indoor	W.B.	59~75°F (15~24°C)	
	Inlet water	°F	50~113°F (10~45°C)	
Heating capacity (Nominal)	*2	BTU/h	378,000	
		kW	110.8	
	(208-230)	Power input	kW	20.77
		Current input	A	64.0-57.9
	(Rated)		BTU/h	360,000
			kW	105.5
(208-230)	Power input	kW	18.91	
	Current input	A	58.3-52.7	
Temp. range of heating	Indoor	D.B.	59~81°F (15~27°C)	
	Inlet water	°F	50~113°F (10~45°C)	
Indoor unit connectable	Total capacity	50~150% of heat source unit capacity		
	Model/Quantity	P04~P96/2~50 (Connectable branch pipe number is max. 48.)		
Sound pressure level (measured in anechoic room)	dB <A>	59.0		
Refrigerant piping diameter	High pressure	in. (mm)	1-1/8 (28.58) Braze	
	Low pressure	in. (mm)	1-5/8 (41.28) Braze	

Set Model		PQR-Y-P168TLMU-A1	
Model		PQR-Y-P168TLMU-A1	PQR-Y-P168TLMU-A1
Minimum Circuit Ampacity	A	44-39	44-39
Maximum Overcurrent Protection	A	70-70	70-70
Circulating water	Water flow rate	G/h	1,902 + 1,902
		G/min	31.7 + 31.7
		m ³ /h	7.20 + 7.20
		L/min	120 + 120
		cfm	4.2 + 4.2
	Pressure drop	psi	6.38
	kPa	44	44
Operating volume range	G/h	1,189 + 1,189 ~ 3,054 + 3,054	
	G/min	19.8 + 19.8 ~ 50.9 + 50.9	
	m ³ /h	4.5 + 4.5 ~ 11.6 + 11.6	
Compressor	Type x Quantity	Inverter scroll hermetic compressor x 1	Inverter scroll hermetic compressor x 1
	Starting method	Inverter	Inverter
	Motor output	kW	11.0
	Case heater	kW	-
	Lubricant		MEL32
External finish		Galvanized steel sheets	Galvanized steel sheets
External dimension H x W x D	in.	57-1/8 x 34-11/16 x 21-11/16	57-1/8 x 34-11/16 x 21-11/16
	mm	1,450 x 880 x 550	1,450 x 880 x 550
Protection devices	High pressure protection	High pressure sensor, High pressure switch at 4.15 MPa (601 psi)	High pressure sensor, High pressure switch at 4.15 MPa (601 psi)
	Inverter circuit	Over-heat protection, Over-current protection	Over-heat protection, Over-current protection
	Compressor	Over-heat protection	Over-heat protection
Refrigerant	Type x original charge	R410A x 13 lbs + 4 oz (6.0 kg)	R410A x 13 lbs + 4 oz (6.0 kg)
	Control	Indoor LEV and BC controller	
Net weight	lbs (kg)	481 (218)	481 (218)
Heat exchanger	Water volume in plate	plate type	plate type
		G	1.32
	l	5.0	
	Water pressure Max.	psi	290
MPa		2.0	
HIC circuit (HIC: Heat Inter-Changer)		-	-
Pipe between unit and distributor	High pressure	in. (mm)	7/8 (22.2) Braze
	Low pressure	in. (mm)	-
Drawing	External	KL94C220	
	Wiring	KE94G423	KE94G423
Standard attachment	Document	Installation Manual	
	Accessory	Details refer to External Drw	
Optional parts		Heat Source Twinning kit: CMY-Q200CBK joint: CMY-Y102SS-G2, CMY-Y102LS-G2, CMY-R160-J1 Main BC controller: CMB-P108, 1012, 1016NU-JA1, CMB-P1016NU-KA1 Sub BC controller: CMB-P104, 108NU-KB1	
Remarks		Details on foundation work, duct work, insulation work, electrical wiring, power source switch, and other items shall be referred to the Installation Manual. Due to continuing improvement, above specifications may be subject to change without notice. The ambient temperature of the Heat Source Unit needs to be kept below 104°F D.B. (40°C D.B.). The ambient relative humidity of the Heat Source Unit needs to be kept below 80%. The Heat Source Unit should not be installed at outdoor. Be sure to mount a strainer (more than 50 meshes) at the water inlet piping of the unit. Be sure to provide interlocking for the unit operation and water circuit. The Heat Source twinning kit (low pressure) should be connected to the low pressure side of the heat source unit. Install the supplied insulation material to the unused drain-socket. When installing insulation material around both water and refrigerant piping, follow the installation manual. The cooling tower and the water circuit must be a closed circuit (water is not exposed to the atmosphere).	

Notes:	Unit converter
1. Nominal cooling conditions (Test conditions are based on AHRI 1230) Indoor: 81°F D.B./66°F W.B. (27°C D.B./19°C W.B.), Inlet water temperature: 86°F (30°C)	BTU/h = kW x 3,412
2. Nominal heating conditions (Test conditions are based on AHRI 1230) Indoor: 68°F D.B. (20°C D.B.), Inlet water temperature: 68°F (20°C)	cfm = m ³ /min x 35.31
	lbs = kg/0.4536
	*Above specification data is subject to rounding variation.

1. SPECIFICATIONS

WR2-Series

PQRY-P-T(S)LMU-A1, Y(S)LMU-A1

Heat Source Model		PQRY-P72YLMU-A1		
Indoor Model		Non-Ducted	Ducted	
Power source		3-phase 3-wire 460 V ±10% 60 Hz		
Cooling capacity (Nominal)	*1	BTU/h	72,000	
		kW	21.1	
	(460)	Power input kW	3.61	
	(Rated)	Current input A	5.0	
		BTU/h	69,000	
		kW	20.2	
	(460)	Power input kW	3.60	3.59
		Current input A	5.0	5.0
	Temp. range of cooling	Indoor	W.B.	59~75°F (15~24°C)
		Inlet water	°F	50~113°F (10~45°C)
Heating capacity (Nominal)	*2	BTU/h	80,000	
		kW	23.4	
	(460)	Power input kW	4.04	
	(Rated)	Current input A	5.6	
		BTU/h	76,000	
		kW	22.3	
	(460)	Power input kW	3.78	3.36
		Current input A	5.2	4.6
	Temp. range of heating	Indoor	D.B.	59~81°F (15~27°C)
		Inlet water	°F	50~113°F (10~45°C)
Indoor unit connectable	Total capacity	50~150% of heat source unit capacity		
	Model/Quantity	P04-P96/1~18		
Sound pressure level (measured in anechoic room)		dB <A>		
		46.0		
Refrigerant piping diameter	High pressure	in. (mm)	5/8 (15.88) Brazed	
	Low pressure	in. (mm)	3/4 (19.05) Brazed	
Minimum Circuit Ampacity		A		
		6		
Maximum Overcurrent Protection		A		
		15		
Circulating water	Water flow rate	G/h	1,522	
		G/min	25.4	
		m ³ /h	5.76	
		L/min	96	
		cfm	3.4	
	Pressure drop	psi	3.48	
		kPa	24	
	Operating volume range	G/h	793 ~ 1,902	
		G/min	13.2 ~ 31.7	
		m ³ /h	3.0 ~ 7.2	
Compressor	Type x Quantity		Inverter scroll hermetic compressor x 1	
	Starting method		Inverter	
	Motor output	kW	4.3	
	Case heater	kW	-	
	Lubricant		MEL32	
External finish		Galvanized steel sheets		
External dimension H x W x D	in.	43-5/16 x 34-11/16 x 21-11/16		
	mm	1,100 x 880 x 550		
Protection devices	High pressure protection	High pressure sensor, High pressure switch at 4.15 MPa (601 psi)		
	Inverter circuit	Over-heat protection, Over-current protection		
	Compressor	Over-heat protection		
Refrigerant	Type x original charge	R410A x 11 lbs + 1 oz (5.0 kg)		
	Control	Indoor LEV and BC controller		
Net weight	lbs (kg)	406 (184)		
Heat exchanger			plate type	
	Water volume in plate	G	1.32	
		l	5.0	
	Water pressure Max.	psi	290	
MPa		2.0		
HIC circuit (HIC: Heat Inter-Changer)		-		
Drawing	External	KL94C210		
	Wiring	KE94G419		
Standard attachment	Document	Installation Manual		
	Accessory	Details refer to External Drw		
Optional parts		joint: CMY-Y102SS-G2, CMY-Y102LS-G2, CMY-R160-J1 BC controller: CMB-P104, 106, 108, 1012, 1016NU-J1 Main BC controller: CMB-P108, 1012, 1016NU-JA1, CMB-P1016NU-KA1 Sub BC controller: CMB-P104, 108NU-KB1		
Remarks	Details on foundation work, duct work, insulation work, electrical wiring, power source switch, and other items shall be referred to the Installation Manual. Due to continuing improvement, above specifications may be subject to change without notice. The ambient temperature of the Heat Source Unit needs to be kept below 104°F.D.B. (40°C.D.B.) The ambient relative humidity of the Heat Source Unit needs to be kept below 80%. The Heat Source Unit should not be installed at outdoor. Be sure to mount a strainer (more than 50 meshes) at the water inlet piping of the unit. Be sure to provide interlocking for the unit operation and water circuit. Install the supplied insulation material to the unused drain-socket. When installing insulation material around both water and refrigerant piping, follow the installation manual. The cooling tower and the water circuit must be a closed circuit (water is not exposed to the atmosphere).			

Notes:	Unit converter
1.Nominal cooling conditions (Test conditions are based on AHRI 1230) Indoor: 81°F.D.B./66°F.W.B. (27°C.D.B./19°C.W.B.), Inlet water temperature: 86°F (30°C)	BTU/h =kW x 3,412
2.Nominal heating conditions (Test conditions are based on AHRI 1230) Indoor: 68°F.D.B. (20°C.D.B.), Inlet water temperature: 68°F (20°C)	cfm =m ³ /min x 35.31
	lbs =kg/0.4536
	*Above specification data is subject to rounding variation.

1. SPECIFICATIONS

Heat Source Model		PQRY-P96YLMU-A1		
Indoor Model		Non-Ducted	Ducted	
Power source		3-phase 3-wire 460 V ±10% 60 Hz		
Cooling capacity (Nominal)	*1	BTU/h	96,000	
		kW	28.1	
	(460)	Power input	kW	5.21
		Current input	A	7.2
	(Rated)		BTU/h	92,000
			kW	27.0
(460)	Power input	kW	5.22	
	Current input	A	7.2	
Temp. range of cooling	Indoor	W.B.	59~75°F (15~24°C)	
	Inlet water	°F	50~113°F (10~45°C)	
Heating capacity (Nominal)	*2	BTU/h	108,000	
		kW	31.7	
	(460)	Power input	kW	5.64
		Current input	A	7.8
	(Rated)		BTU/h	103,000
			kW	30.2
(460)	Power input	kW	5.34	
	Current input	A	7.4	
Temp. range of heating	Indoor	D.B.	59~81°F (15~27°C)	
	Inlet water	°F	50~113°F (10~45°C)	
Indoor unit connectable	Total capacity	50~150% of heat source unit capacity		
	Model/Quantity	P04-P96/1~24		
Sound pressure level (measured in anechoic room)	dB <A>	48.0		
Refrigerant piping diameter	High pressure	in. (mm)	3/4 (19.05) Brazed	
	Low pressure	in. (mm)	7/8 (22.2) Brazed	
Minimum Circuit Ampacity	A	9		
Maximum Overcurrent Protection	A	15		
Circulating water	Water flow rate	G/h	1,522	
		G/min	25.4	
		m ³ /h	5.76	
		L/min	96	
		cfm	3.4	
	Pressure drop	psi	3.48	
		kPa	24	
	Operating volume range	G/h	793 ~ 1,902	
G/min		13.2 ~ 31.7		
m ³ /h		3.0 ~ 7.2		
Compressor	Type x Quantity	Inverter scroll hermetic compressor x 1		
	Starting method	Inverter		
	Motor output	kW	6.0	
	Case heater	kW	-	
	Lubricant	MEL32		
External finish	Galvanized steel sheets			
External dimension H x W x D	in.	43-5/16 x 34-11/16 x 21-11/16		
	mm	1,100 x 880 x 550		
Protection devices	High pressure protection	High pressure sensor, High pressure switch at 4.15 MPa (601 psi)		
	Inverter circuit	Over-heat protection, Over-current protection		
	Compressor	Over-heat protection		
Refrigerant	Type x original charge	R410A x 11 lbs + 1 oz (5.0 kg)		
	Control	Indoor LEV and BC controller		
Net weight	lbs (kg)	406 (184)		
Heat exchanger	Water volume in plate	G	1.32	
		l	5.0	
	Water pressure Max.	psi	290	
		MPa	2.0	
HIC circuit (HIC: Heat Inter-Changer)	-			
Drawing	External	KL94C210		
	Wiring	KE94G419		
Standard attachment	Document	Installation Manual		
	Accessory	Details refer to External Drw		
Optional parts	joint: CMY-Y102SS-G2, CMY-Y102LS-G2, CMY-R160-J1 BC controller: CMB-P104, 106, 108, 1012, 1016NU-J1 Main BC controller: CMB-P108, 1012, 1016NU-JA1, CMB-P1016NU-KA1 Sub BC controller: CMB-P104, 108NU-KB1			
Remarks	Details on foundation work, duct work, insulation work, electrical wiring, power source switch, and other items shall be referred to the Installation Manual. Due to continuing improvement, above specifications may be subject to change without notice. The ambient temperature of the Heat Source Unit needs to be kept below 104°F.D.B. (40°C.D.B.) The ambient relative humidity of the Heat Source Unit needs to be kept below 80%. The Heat Source Unit should not be installed at outdoor. Be sure to mount a strainer (more than 50 meshes) at the water inlet piping of the unit. Be sure to provide interlocking for the unit operation and water circuit. Install the supplied insulation material to the unused drain-socket. When installing insulation material around both water and refrigerant piping, follow the installation manual. The cooling tower and the water circuit must be a closed circuit (water is not exposed to the atmosphere).			

Notes: 1.Nominal cooling conditions (Test conditions are based on AHRI 1230) Indoor: 81°F.D.B./66°F.W.B. (27°C.D.B./19°C.W.B.), Inlet water temperature: 86°F (30°C) 2.Nominal heating conditions (Test conditions are based on AHRI 1230) Indoor: 68°F.D.B. (20°C.D.B.), Inlet water temperature: 68°F (20°C)	Unit converter
	BTU/h =kW x 3,412
	cfm =m ³ /min x 35.31
	lbs =kg/0.4536
	*Above specification data is subject to rounding variation.

1. SPECIFICATIONS

PQRY-P-T(S)LMU-A1, Y(S)LMU-A1

Heat Source Model		PQRY-P120YLMU-A1		
Indoor Model		Non-Ducted	Ducted	
Power source		3-phase 3-wire 460 V ±10% 60 Hz		
Cooling capacity (Nominal)	*1	BTU/h	120,000	
		kW	35.2	
	(460)	Power input	kW	7.51
		Current input	A	10.4
	(Rated)		BTU/h	115,000
			kW	33.7
(460)	Power input	kW	7.38	
	Current input	A	10.2	
Temp. range of cooling	Indoor	W.B.	59~75°F (15~24°C)	
	Inlet water	°F	50~113°F (10~45°C)	
Heating capacity (Nominal)	*2	BTU/h	135,000	
		kW	39.6	
	(460)	Power input	kW	7.09
		Current input	A	9.8
	(Rated)		BTU/h	129,000
			kW	37.8
(460)	Power input	kW	6.61	
	Current input	A	9.2	
Temp. range of heating	Indoor	D.B.	59~81°F (15~27°C)	
	Inlet water	°F	50~113°F (10~45°C)	
Indoor unit connectable	Total capacity	50~150% of heat source unit capacity		
	Model/Quantity	P04~P96/1~30		
Sound pressure level (measured in anechoic room)	dB <A>	54.0		
Refrigerant piping diameter	High pressure	in. (mm)	3/4 (19.05) Brazed	
	Low pressure	in. (mm)	7/8 (22.2) Brazed	
Minimum Circuit Ampacity	A	13		
Maximum Overcurrent Protection	A	20		
Circulating water	Water flow rate	G/h	1,522	
		G/min	25.4	
		m ³ /h	5.76	
		L/min	96	
		cfm	3.4	
	Pressure drop	psi	3.48	
		kPa	24	
	Operating volume range	G/h	793 ~ 1,902	
G/min		13.2 ~ 31.7		
m ³ /h		3.0 ~ 7.2		
Compressor	Type x Quantity	Inverter scroll hermetic compressor x 1		
	Starting method	Inverter		
	Motor output	kW	7.7	
	Case heater	kW	-	
	Lubricant	MEL32		
External finish	Galvanized steel sheets			
External dimension H x W x D	in.	43-5/16 x 34-11/16 x 21-11/16		
	mm	1,100 x 880 x 550		
Protection devices	High pressure protection	High pressure sensor, High pressure switch at 4.15 MPa (601 psi)		
	Inverter circuit	Over-heat protection, Over-current protection		
	Compressor	Over-heat protection		
Refrigerant	Type x original charge	R410A x 11 lbs + 1 oz (5.0 kg)		
	Control	Indoor LEV and BC controller		
Net weight	lbs (kg)	406 (184)		
Heat exchanger	Water volume in plate	G	1.32	
		l	5.0	
	Water pressure Max.	psi	290	
		MPa	2.0	
HIC circuit (HIC: Heat Inter-Changer)	-			
Drawing	External	KL94C210		
	Wiring	KE94G419		
Standard attachment	Document	Installation Manual		
	Accessory	Details refer to External Drw		
Optional parts	joint: CMY-Y102SS-G2, CMY-Y102LS-G2, CMY-R160-J1 BC controller: CMB-P104, 106, 108, 1012, 1016NU-J1 Main BC controller: CMB-P108, 1012, 1016NU-JA1, CMB-P1016NU-KA1 Sub BC controller: CMB-P104, 108NU-KB1			
Remarks	Details on foundation work, duct work, insulation work, electrical wiring, power source switch, and other items shall be referred to the Installation Manual. Due to continuing improvement, above specifications may be subject to change without notice. The ambient temperature of the Heat Source Unit needs to be kept below 104°F.D.B. (40°C.D.B.) The ambient relative humidity of the Heat Source Unit needs to be kept below 80%. The Heat Source Unit should not be installed at outdoor. Be sure to mount a strainer (more than 50 meshes) at the water inlet piping of the unit. Be sure to provide interlocking for the unit operation and water circuit. Install the supplied insulation material to the unused drain-socket. When installing insulation material around both water and refrigerant piping, follow the installation manual. The cooling tower and the water circuit must be a closed circuit (water is not exposed to the atmosphere).			

Notes:	Unit converter
1.Nominal cooling conditions (Test conditions are based on AHRI 1230) Indoor: 81°F.D.B./66°F.W.B. (27°C.D.B./19°C.W.B.), Inlet water temperature: 86°F (30°C)	BTU/h =kW x 3,412
2.Nominal heating conditions (Test conditions are based on AHRI 1230) Indoor: 68°F.D.B. (20°C.D.B.), Inlet water temperature: 68°F (20°C)	cfm =m ³ /min x 35.31
	lbs =kg/0.4536
	*Above specification data is subject to rounding variation.

1. SPECIFICATIONS

Heat Source Model		PQR-Y-P144YLMU-A1		
Indoor Model		Non-Ducted	Ducted	
Power source		3-phase 3-wire 460 V ±10% 60 Hz		
Cooling capacity (Nominal)	*1	BTU/h	144,000	
		kW	42.2	
	(460)	Power input	kW	8.78
		Current input	A	12.2
	(Rated)		BTU/h	138,000
			kW	40.4
(460)	Power input	kW	9.44	
	Current input	A	13.1	
Temp. range of cooling	Indoor	W.B.	59~75°F (15~24°C)	
	Inlet water	°F	50~113°F (10~45°C)	
Heating capacity (Nominal)	*2	BTU/h	160,000	
		kW	46.9	
	(460)	Power input	kW	8.11
		Current input	A	11.3
	(Rated)		BTU/h	152,000
			kW	44.5
(460)	Power input	kW	7.43	
	Current input	A	10.3	
Temp. range of heating	Indoor	D.B.	59~81°F (15~27°C)	
	Inlet water	°F	50~113°F (10~45°C)	
Indoor unit connectable	Total capacity	50~150% of heat source unit capacity		
	Model/Quantity	P04~P96/1~36		
Sound pressure level (measured in anechoic room)	dB <A>	54.0		
Refrigerant piping diameter	High pressure	in. (mm)	7/8 (22.2) Brazed	
	Low pressure	in. (mm)	1-1/8 (28.58) Brazed	
Minimum Circuit Ampacity	A	16		
Maximum Overcurrent Protection	A	25		
Circulating water	Water flow rate	G/h	1,902	
		G/min	31.7	
		m ³ /h	7.20	
		L/min	120	
		cfm	4.2	
	Pressure drop	psi	6.38	
		kPa	44	
	Operating volume range	G/h	1,189 ~ 3,054	
G/min		19.8 ~ 50.9		
m ³ /h		4.5 ~ 11.6		
Compressor	Type x Quantity	Inverter scroll hermetic compressor x 1		
	Starting method	Inverter		
	Motor output	kW	9.5	
	Case heater	kW	-	
	Lubricant	MEL32		
External finish	Galvanized steel sheets			
External dimension H x W x D	in.	57-1/8 x 34-11/16 x 21-11/16		
	mm	1,450 x 880 x 550		
Protection devices	High pressure protection	High pressure sensor, High pressure switch at 4.15 MPa (601 psi)		
	Inverter circuit	Over-heat protection, Over-current protection		
	Compressor	Over-heat protection		
Refrigerant	Type x original charge	R410A x 13 lbs + 4 oz (6.0 kg)		
	Control	Indoor LEV and BC controller		
Net weight	lbs (kg)	508 (230)		
Heat exchanger	Water volume in plate	G	1.32	
		l	5.0	
	Water pressure Max.	psi	290	
		MPa	2.0	
HIC circuit (HIC: Heat Inter-Changer)	-			
Drawing	External	KL94C211		
	Wiring	KE94G419		
Standard attachment	Document	Installation Manual		
	Accessory	Details refer to External Drw		
Optional parts	joint: CMY-Y102SS-G2, CMY-Y102LS-G2, CMY-R160-J1 Main BC controller: CMB-P108, 1012, 1016NU-JA1, CMB-P1016NU-KA1 Sub BC controller: CMB-P104, 108NU-KB1			
Remarks	<p>Details on foundation work, duct work, insulation work, electrical wiring, power source switch, and other items shall be referred to the Installation Manual.</p> <p>Due to continuing improvement, above specifications may be subject to change without notice.</p> <p>The ambient temperature of the Heat Source Unit needs to be kept below 104°F D.B. (40°C D.B.).</p> <p>The ambient relative humidity of the Heat Source Unit needs to be kept below 80%.</p> <p>The Heat Source Unit should not be installed at outdoor.</p> <p>Be sure to mount a strainer (more than 50 meshes) at the water inlet piping of the unit.</p> <p>Be sure to provide interlocking for the unit operation and water circuit.</p> <p>Install the supplied insulation material to the unused drain-socket.</p> <p>When installing insulation material around both water and refrigerant piping, follow the installation manual.</p> <p>The cooling tower and the water circuit must be a closed circuit (water is not exposed to the atmosphere).</p>			

Notes:	Unit converter
1.Nominal cooling conditions (Test conditions are based on AHRI 1230) Indoor: 81°F D.B./66°F W.B. (27°C D.B./19°C W.B.), Inlet water temperature: 86°F (30°C)	BTU/h =kW x 3,412
2.Nominal heating conditions (Test conditions are based on AHRI 1230) Indoor: 68°F D.B. (20°C D.B.), Inlet water temperature: 68°F (20°C)	cfm =m ³ /min x 35.31
	lbs =kg/0.4536
	*Above specification data is subject to rounding variation.

1. SPECIFICATIONS

PQRY-P-T(S)LMU-A1, Y(S)LMU-A1

Heat Source Model		PQRY-P168YLMU-A1		
Indoor Model		Non-Ducted	Ducted	
Power source		3-phase 3-wire 460 V ±10% 60 Hz		
Cooling capacity (Nominal)	*1	BTU/h	168,000	
		kW	49.2	
	(460)	Power input	kW	12.05
		Current input	A	16.8
	(Rated)		BTU/h	160,000
			kW	46.9
(460)	Power input	kW	11.98	
	Current input	A	16.7	
Temp. range of cooling	Indoor	W.B.	59~75°F (15~24°C)	
	Inlet water	°F	50~113°F (10~45°C)	
Heating capacity (Nominal)	*2	BTU/h	188,000	
		kW	55.1	
	(460)	Power input	kW	9.86
		Current input	A	13.7
	(Rated)		BTU/h	178,000
			kW	52.2
(460)	Power input	kW	8.96	
	Current input	A	12.4	
Temp. range of heating	Indoor	D.B.	59~81°F (15~27°C)	
	Inlet water	°F	50~113°F (10~45°C)	
Indoor unit connectable	Total capacity	50~150% of heat source unit capacity		
	Model/Quantity	P04~P96/1~42		
Sound pressure level (measured in anechoic room)	dB <A>	56.0		
Refrigerant piping diameter	High pressure	in. (mm)	7/8 (22.2) Brazed	
	Low pressure	in. (mm)	1-1/8 (28.58) Brazed	
Minimum Circuit Ampacity	A	20		
Maximum Overcurrent Protection	A	35		
Circulating water	Water flow rate	G/h	1,902	
		G/min	31.7	
		m ³ /h	7.20	
		L/min	120	
		cfm	4.2	
	Pressure drop	psi	6.38	
		kPa	44	
	Operating volume range	G/h	1,189 ~ 3,054	
G/min		19.8 ~ 50.9		
m ³ /h		4.5 ~ 11.6		
Compressor	Type x Quantity	Inverter scroll hermetic compressor x 1		
	Starting method	Inverter		
	Motor output	kW	11.0	
	Case heater	kW	-	
	Lubricant	MEL32		
External finish	Galvanized steel sheets			
External dimension H x W x D	in.	57-1/8 x 34-11/16 x 21-11/16		
	mm	1,450 x 880 x 550		
Protection devices	High pressure protection	High pressure sensor, High pressure switch at 4.15 MPa (601 psi)		
	Inverter circuit	Over-heat protection, Over-current protection		
	Compressor	Over-heat protection		
Refrigerant	Type x original charge	R410A x 13 lbs + 4 oz (6.0 kg)		
	Control	Indoor LEV and BC controller		
Net weight	lbs (kg)	508 (230)		
Heat exchanger	Water volume in plate	G	1.32	
		l	5.0	
	Water pressure Max.	psi	290	
		MPa	2.0	
HIC circuit (HIC: Heat Inter-Changer)	-			
Drawing	External	KL94C211		
	Wiring	KE94G419		
Standard attachment	Document	Installation Manual		
	Accessory	Details refer to External Drw		
Optional parts	joint: CMY-Y102SS-G2, CMY-Y102LS-G2, CMY-R160-J1 Main BC controller: CMB-P108, 1012, 1016NU-JA1, CMB-P1016NU-KA1 Sub BC controller: CMB-P104, 108NU-KB1			
Remarks	Details on foundation work, duct work, insulation work, electrical wiring, power source switch, and other items shall be referred to the Installation Manual. Due to continuing improvement, above specifications may be subject to change without notice. The ambient temperature of the Heat Source Unit needs to be kept below 104°F.D.B. (40°C.D.B.) The ambient relative humidity of the Heat Source Unit needs to be kept below 80%. The Heat Source Unit should not be installed at outdoor. Be sure to mount a strainer (more than 50 meshes) at the water inlet piping of the unit. Be sure to provide interlocking for the unit operation and water circuit. Install the supplied insulation material to the unused drain-socket. When installing insulation material around both water and refrigerant piping, follow the installation manual. The cooling tower and the water circuit must be a closed circuit (water is not exposed to the atmosphere).			

Notes:	Unit converter
1.Nominal cooling conditions (Test conditions are based on AHRI 1230) Indoor: 81°F.D.B./66°F.W.B. (27°C.D.B./19°C.W.B.), Inlet water temperature: 86°F (30°C)	BTU/h =kW x 3.412
2.Nominal heating conditions (Test conditions are based on AHRI 1230) Indoor: 68°F.D.B. (20°C.D.B.), Inlet water temperature: 68°F (20°C)	cfm =m ³ /min x 35.31
	lbs =kg/0.4536
	*Above specification data is subject to rounding variation.

1. SPECIFICATIONS

PQR-Y-P-T(S)LMU-A1, Y(S)LMU-A1

Heat Source Model		PQR-Y-P192YLMU-A1		
Indoor Model		Non-Ducted	Ducted	
Power source		3-phase 3-wire 460 V ±10% 60 Hz		
Cooling capacity (Nominal)	*1	BTU/h	192,000	
		kW	56.3	
	(460)	Power input	kW	15.05
		Current input	A	20.9
	(Rated)		BTU/h	184,000
			kW	53.9
(460)	Power input	kW	15.17	
	Current input	A	21.1	
Temp. range of cooling	Indoor	W.B.	59~75°F (15~24°C)	
	Inlet water	°F	50~113°F (10~45°C)	
Heating capacity (Nominal)	*2	BTU/h	215,000	
		kW	63.0	
	(460)	Power input	kW	11.90
		Current input	A	16.5
	(Rated)		BTU/h	204,000
			kW	59.8
(460)	Power input	kW	10.84	
	Current input	A	15.1	
Temp. range of heating	Indoor	D.B.	59~81°F (15~27°C)	
	Inlet water	°F	50~113°F (10~45°C)	
Indoor unit connectable	Total capacity	50~150% of heat source unit capacity		
	Model/Quantity	P04-P96/1~48		
Sound pressure level (measured in anechoic room)		dB <A>	58.0	
Refrigerant piping diameter	High pressure	in. (mm)	7/8 (22.2) Brazed	
	Low pressure	in. (mm)	1-1/8 (28.58) Brazed	
Minimum Circuit Ampacity		A	25	
Maximum Overcurrent Protection		A	40	
Circulating water	Water flow rate	G/h	1,902	
		G/min	31.7	
		m ³ /h	7.20	
		L/min	120	
		cfm	4.2	
	Pressure drop	psi	6.38	
		kPa	44	
	Operating volume range	G/h	1,189 ~ 3,054	
G/min		19.8 ~ 50.9		
m ³ /h		4.5 ~ 11.6		
Compressor	Type x Quantity		Inverter scroll hermetic compressor x 1	
	Starting method		Inverter	
	Motor output	kW	12.4	
	Case heater	kW	-	
	Lubricant		MEL32	
External finish		Galvanized steel sheets		
External dimension H x W x D	in.	57-1/8 x 34-11/16 x 21-11/16		
	mm	1,450 x 880 x 550		
Protection devices	High pressure protection		High pressure sensor, High pressure switch at 4.15 MPa (601 psi)	
	Inverter circuit		Over-heat protection, Over-current protection	
	Compressor		Over-heat protection	
Refrigerant	Type x original charge		R410A x 13 lbs + 4 oz (6.0 kg)	
	Control		Indoor LEV and BC controller	
Net weight		lbs (kg)	508 (230)	
Heat exchanger		plate type		
	Water volume in plate	G	1.32	
		l	5.0	
	Water pressure Max.	psi	290	
		MPa	2.0	
HIC circuit (HIC: Heat Inter-Changer)		-		
Drawing	External	KL94C211		
	Wiring	KE94G419		
Standard attachment	Document	Installation Manual		
	Accessory	Details refer to External Drw		
Optional parts		joint: CMY-Y102SS-G2, CMY-Y102LS-G2, CMY-R160-J1 Main BC controller: CMB-P108, 1012, 1016NU-JA1, CMB-P1016NU-KA1 Sub BC controller: CMB-P104, 108NU-KB1		
Remarks		Details on foundation work, duct work, insulation work, electrical wiring, power source switch, and other items shall be referred to the Installation Manual. Due to continuing improvement, above specifications may be subject to change without notice. The ambient temperature of the Heat Source Unit needs to be kept below 104°F D.B. (40°C D.B.). The ambient relative humidity of the Heat Source Unit needs to be kept below 80%. The Heat Source Unit should not be installed at outdoor. Be sure to mount a strainer (more than 50 meshes) at the water inlet piping of the unit. Be sure to provide interlocking for the unit operation and water circuit. Install the supplied insulation material to the unused drain-socket. When installing insulation material around both water and refrigerant piping, follow the installation manual. The cooling tower and the water circuit must be a closed circuit (water is not exposed to the atmosphere).		

Notes:	Unit converter
1.Nominal cooling conditions (Test conditions are based on AHRI 1230) Indoor: 81°F D.B./66°F W.B. (27°C D.B./19°C W.B.), Inlet water temperature: 86°F (30°C)	BTU/h =kW x 3,412
2.Nominal heating conditions (Test conditions are based on AHRI 1230) Indoor: 68°F D.B. (20°C D.B.), Inlet water temperature: 68°F (20°C)	cfm =m ³ /min x 35.31
	lbs =kg/0.4536
	*Above specification data is subject to rounding variation.

1. SPECIFICATIONS

WR2-Series

PQRY-P-T(S)LMU-A1, Y(S)LMU-A1

Heat Source Model		PQRY-P216YLMU-A1		
Indoor Model		Non-Ducted	Ducted	
Power source		3-phase 3-wire 460 V ±10% 60 Hz		
Cooling capacity (Nominal)	*1	BTU/h	216,000	
		kW	63.3	
	(460)	Power input	kW	
		Current input	A	
	(Rated)	BTU/h	206,000	
		kW	60.4	
(460)	Power input	18.12	17.22	
	Current input	25.2	24.0	
Temp. range of cooling	Indoor	W.B. 59~75°F (15~24°C)		
	Inlet water	°F 50~113°F (10~45°C)		
Heating capacity (Nominal)	*2	BTU/h	243,000	
		kW	71.2	
	(460)	Power input	kW	
		Current input	A	
	(Rated)	BTU/h	232,000	
		kW	68.0	
(460)	Power input	11.96	12.07	
	Current input	16.6	16.8	
Temp. range of heating	Indoor	D.B. 59~81°F (15~27°C)		
	Inlet water	°F 50~113°F (10~45°C)		
Indoor unit connectable	Total capacity	50~150% of heat source unit capacity		
	Model/Quantity	P04~P96/2~50 (Connectable branch pipe number is max. 48.)		
Sound pressure level (measured in anechoic room)	dB <A>	58.0		
Refrigerant piping diameter	High pressure	in. (mm) 7/8 (22.2) Brazed (1-1/8 (28.58) Brazed for the part that exceeds 65 m)		
	Low pressure	in. (mm) 1-1/8 (28.58) Brazed		
Minimum Circuit Ampacity	A	31		
Maximum Overcurrent Protection	A	50		
Circulating water	Water flow rate	G/h	3,044	
		G/min	50.7	
		m ³ /h	11.52	
		L/min	192	
		cfm	6.8	
	Pressure drop	psi	6.53	
		kPa	45	
Operating volume range	G/h	1,585 ~ 3,804		
	G/min	26.4 ~ 63.4		
	m ³ /h	6.0 ~ 14.4		
Compressor	Type x Quantity	Inverter scroll hermetic compressor x 1		
	Starting method	Inverter		
	Motor output	kW 14.5		
	Case heater	kW 0.045		
	Lubricant	MEL32		
External finish	Galvanized steel sheets			
External dimension H x W x D	in.	57-1/8 x 34-11/16 x 21-11/16		
	mm	1,450 x 880 x 550		
Protection devices	High pressure protection	High pressure sensor, High pressure switch at 4.15 MPa (601 psi)		
	Inverter circuit	Over-heat protection, Over-current protection		
	Compressor	Over-heat protection		
Refrigerant	Type x original charge	R410A x 25 lbs + 13 oz (11.7 kg)		
	Control	Indoor LEV and BC controller		
Net weight	lbs (kg)	574 (260)		
Heat exchanger	Water volume in plate	G	2.64	
		l	10.0	
	Water pressure Max.	psi	290	
		MPa	2.0	
HIC circuit (HIC: Heat Inter-Changer)	-			
Drawing	External	KL94C212		
	Wiring	KE94G419		
Standard attachment	Document	Installation Manual		
	Accessory	Details refer to External Drw		
Optional parts	joint: CMY-Y102SS-G2, CMY-Y102LS-G2, CMY-R160-J1 Main BC controller: CMB-P108, 1012, 1016NU-JA1, CMB-P1016NU-KA1 Sub BC controller: CMB-P104, 108NU-KB1			
Remarks	<p>Details on foundation work, duct work, insulation work, electrical wiring, power source switch, and other items shall be referred to the Installation Manual.</p> <p>Due to continuing improvement, above specifications may be subject to change without notice.</p> <p>The ambient temperature of the Heat Source Unit needs to be kept below 104°F D.B. (40°C D.B.)</p> <p>The ambient relative humidity of the Heat Source Unit needs to be kept below 80%.</p> <p>The Heat Source Unit should not be installed at outdoor.</p> <p>Be sure to mount a strainer (more than 50 meshes) at the water inlet piping of the unit.</p> <p>Be sure to provide interlocking for the unit operation and water circuit.</p> <p>Install the supplied insulation material to the unused drain-socket.</p> <p>When installing insulation material around both water and refrigerant piping, follow the installation manual.</p> <p>When the high pressure piping length is 65 m or less, use 7/8 (22.2) pipe. When the high pressure piping length exceeds 65 m, use 7/8 (22.2) pipe until 65 m, use 1-1/8 (28.58) pipe for the part that exceeds 65 m.</p> <p>The cooling tower and the water circuit must be a closed circuit (water is not exposed to the atmosphere).</p>			

Notes:	Unit converter
1. Nominal cooling conditions (Test conditions are based on AHRI 1230) Indoor: 81°F D.B./66°F W.B. (27°C D.B./19°C W.B.), Inlet water temperature: 86°F (30°C)	BTU/h = kW x 3,412
2. Nominal heating conditions (Test conditions are based on AHRI 1230) Indoor: 68°F D.B. (20°C D.B.), Inlet water temperature: 68°F (20°C)	cfm = m ³ /min x 35.31
	lbs = kg/0.4536
	*Above specification data is subject to rounding variation.

1. SPECIFICATIONS

Heat Source Model		PQR-Y-P240YLMU-A1		
Indoor Model		Non-Ducted	Ducted	
Power source		3-phase 3-wire 460 V ±10% 60 Hz		
Cooling capacity (Nominal)	*1	BTU/h	224,000	
		kW	65.7	
	(460)	Power input	kW	21.14
		Current input	A	29.4
	(Rated)		BTU/h	214,000
			kW	62.7
(460)	Power input	kW	18.67	
	Current input	A	26.0	
Temp. range of cooling	Indoor	W.B.	59~75°F (15~24°C)	
	Inlet water	°F	50~113°F (10~45°C)	
Heating capacity (Nominal)	*2	BTU/h	270,000	
		kW	79.1	
	(460)	Power input	kW	15.12
		Current input	A	21.0
	(Rated)		BTU/h	258,000
			kW	75.6
(460)	Power input	kW	13.93	
	Current input	A	19.4	
Temp. range of heating	Indoor	D.B.	59~81°F (15~27°C)	
	Inlet water	°F	50~113°F (10~45°C)	
Indoor unit connectable	Total capacity	50~150% of heat source unit capacity		
	Model/Quantity	P04~P96/2~50 (Connectable branch pipe number is max. 48.)		
Sound pressure level (measured in anechoic room)		dB <A>	58.0	
Refrigerant piping diameter	High pressure	in. (mm)	7/8 (22.2) Brazed (1-1/8 (28.58) Brazed for the part that exceeds 65 m)	
	Low pressure	in. (mm)	1-3/8 (34.93) Brazed	
Minimum Circuit Ampacity		A	36	
Maximum Overcurrent Protection		A	60	
Circulating water	Water flow rate	G/h	3,044	
		G/min	50.7	
		m ³ /h	11.52	
		L/min	192	
		cfm	6.8	
	Pressure drop	psi	6.53	
		kPa	45	
	Operating volume range	G/h	1,585 ~ 3,804	
G/min		26.4 ~ 63.4		
m ³ /h		6.0 ~ 14.4		
Compressor	Type x Quantity	Inverter scroll hermetic compressor x 1		
	Starting method	Inverter		
	Motor output	kW	16.1	
	Case heater	kW	0.045	
	Lubricant	MEL32		
External finish	Galvanized steel sheets			
External dimension H x W x D	in.	57-1/8 x 34-11/16 x 21-11/16		
	mm	1,450 x 880 x 550		
Protection devices	High pressure protection	High pressure sensor, High pressure switch at 4.15 MPa (601 psi)		
	Inverter circuit	Over-heat protection, Over-current protection		
	Compressor	Over-heat protection		
Refrigerant	Type x original charge	R410A x 25 lbs + 13 oz (11.7 kg)		
	Control	Indoor LEV and BC controller		
Net weight	lbs (kg)	574 (260)		
Heat exchanger	Water volume in plate	G	2.64	
		l	10.0	
	Water pressure Max.	psi	290	
		MPa	2.0	
HIC circuit (HIC: Heat Inter-Changer)	-			
Drawing	External	KL94C212		
	Wiring	KE94G419		
Standard attachment	Document	Installation Manual		
	Accessory	Details refer to External Drw		
Optional parts	joint: CMY-Y102SS-G2, CMY-Y102LS-G2, CMY-R160-J1 Main BC controller: CMB-P108, 1012, 1016NU-JA1, CMB-P1016NU-KA1 Sub BC controller: CMB-P104, 108NU-KB1			
Remarks	Details on foundation work, duct work, insulation work, electrical wiring, power source switch, and other items shall be referred to the Installation Manual. Due to continuing improvement, above specifications may be subject to change without notice. The ambient temperature of the Heat Source Unit needs to be kept below 104°F D.B. (40°C D.B.). The ambient relative humidity of the Heat Source Unit needs to be kept below 80%. The Heat Source Unit should not be installed at outdoor. Be sure to mount a strainer (more than 50 meshes) at the water inlet piping of the unit. Be sure to provide interlocking for the unit operation and water circuit. Install the supplied insulation material to the unused drain-socket. When installing insulation material around both water and refrigerant piping, follow the installation manual. When the high pressure piping length is 65 m or less, use 7/8 (22.2) pipe. When the high pressure piping length exceeds 65 m, use 7/8 (22.2) pipe until 65 m, use 1-1/8 (28.58) pipe for the part that exceeds 65 m. The cooling tower and the water circuit must be a closed circuit (water is not exposed to the atmosphere).			

Notes: 1.Nominal cooling conditions (Test conditions are based on AHRI 1230) Indoor: 81°F D.B./66°F W.B. (27°C D.B./19°C W.B.), Inlet water temperature: 86°F (30°C) 2.Nominal heating conditions (Test conditions are based on AHRI 1230) Indoor: 68°F D.B. (20°C D.B.), Inlet water temperature: 68°F (20°C)	Unit converter
	BTU/h =kW x 3.412
	cfm =m ³ /min x 35.31
	lbs =kg/0.4536
	*Above specification data is subject to rounding variation.

1. SPECIFICATIONS

PQRY-P-T(S)LMU-A1, Y(S)LMU-A1

Heat Source Model			PQRY-P144YSLMU-A1	
Indoor Model			Non-Ducted	Ducted
Power source			3-phase 3-wire 460 V ±10% 60 Hz	
Cooling capacity (Nominal)	*1	BTU/h	144,000	
		kW	42.2	
	(460)	Power input	7.11	
		Current input	9.9	
	(Rated)	BTU/h	138,000	
		kW	40.4	
(460)	Power input	6.96	8.34	
	Current input	9.7	11.6	
Temp. range of cooling	Indoor	W.B.	59~75°F (15~24°C)	
	Inlet water	°F	50~113°F (10~45°C)	
Heating capacity (Nominal)	*2	BTU/h	160,000	
		kW	46.9	
	(460)	Power input	7.45	
		Current input	10.3	
	(Rated)	BTU/h	152,000	
		kW	44.5	
(460)	Power input	6.86	7.29	
	Current input	9.5	10.1	
Temp. range of heating	Indoor	D.B.	59~81°F (15~27°C)	
	Inlet water	°F	50~113°F (10~45°C)	
Indoor unit connectable	Total capacity	50~150% of heat source unit capacity		
	Model/Quantity	P04-P96/1~36		
Sound pressure level (measured in anechoic room)		dB <A>	49.0	
Refrigerant piping diameter	High pressure	in. (mm)	7/8 (22.2) Brazed	
	Low pressure	in. (mm)	1-1/8 (28.58) Brazed	

Set Model			PQRY-P72YLMU-A1		PQRY-P72YLMU-A1	
Model			PQRY-P72YLMU-A1		PQRY-P72YLMU-A1	
Minimum Circuit Ampacity			6		6	
Maximum Overcurrent Protection			15		15	
Circulating water	Water flow rate	G/h	1,522 + 1,522			
		G/min	25.4 + 25.4			
		m ³ /h	5.76 + 5.76			
		L/min	96 + 96			
		cfm	3.4 + 3.4			
	Pressure drop	psi	3.48		3.48	
kPa		24		24		
Operating volume range	G/h	793 + 793 ~ 1,902 + 1,902				
	G/min	13.2 + 13.2 ~ 31.7 + 31.7				
	m ³ /h	3.0 + 3.0 ~ 7.2 + 7.2				
Compressor	Type x Quantity		Inverter scroll hermetic compressor x 1		Inverter scroll hermetic compressor x 1	
	Starting method		Inverter		Inverter	
	Motor output	kW	4.3		4.3	
	Case heater	kW	-		-	
	Lubricant		MEL32		MEL32	
External finish			Galvanized steel sheets		Galvanized steel sheets	
External dimension H x W x D			in.		43-5/16 x 34-11/16 x 21-11/16	
			mm		1,100 x 880 x 550	
Protection devices	High pressure protection		High pressure sensor, High pressure switch at 4.15 MPa (601 psi)		High pressure sensor, High pressure switch at 4.15 MPa (601 psi)	
	Inverter circuit		Over-heat protection, Over-current protection		Over-heat protection, Over-current protection	
	Compressor		Over-heat protection		Over-heat protection	
Refrigerant	Type x original charge		R410A x 11 lbs + 1 oz (5.0 kg)		R410A x 11 lbs + 1 oz (5.0 kg)	
	Control		Indoor LEV and BC controller			
Net weight			lbs (kg)		406 (184)	
Heat exchanger	Water volume in plate		plate type		plate type	
			G		1.32	
	Water pressure Max.		I		5.0	
			psi		290	
		MPa		2.0		
HIC circuit (HIC: Heat Inter-Change)			-		-	
Pipe between unit and distributor	High pressure		in. (mm)		5/8 (15.88) Brazed	
	Low pressure		in. (mm)		3/4 (19.05) Brazed	
Drawing	External		KL94C221			
	Wiring		KE94G419		KE94G419	
Standard attachment	Document		Installation Manual			
	Accessory		Details refer to External Drw			
Optional parts			Heat Source Twinning kit: CMY-Q100CBK2 joint: CMY-Y102SS-G2, CMY-Y102LS-G2, CMY-R160-J1 Main BC controller: CMB-P108, 1012, 1016NU-JA1, CMB-P1016NU-KA1 Sub BC controller: CMB-P104, 108NU-KB1			
Remarks			<p>Details on foundation work, duct work, insulation work, electrical wiring, power source switch, and other items shall be referred to the Installation Manual.</p> <p>Due to continuing improvement, above specifications may be subject to change without notice.</p> <p>The ambient temperature of the Heat Source Unit needs to be kept below 104°F.D.B. (40°C.D.B.)</p> <p>The ambient relative humidity of the Heat Source Unit needs to be kept below 80%.</p> <p>The Heat Source Unit should not be installed at outdoor.</p> <p>Be sure to mount a strainer (more than 50 meshes) at the water inlet piping of the unit.</p> <p>Be sure to provide interlocking for the unit operation and water circuit.</p> <p>The Heat Source twinning kit (low pressure) should be connected to the low pressure side of the heat source unit.</p> <p>Install the supplied insulation material to the unused drain-socket.</p> <p>When installing insulation material around both water and refrigerant piping, follow the installation manual.</p> <p>The cooling tower and the water circuit must be a closed circuit (water is not exposed to the atmosphere).</p>			

Notes:	Unit converter
1.Nominal cooling conditions (Test conditions are based on AHRI 1230) Indoor: 81°F.D.B./66°F.W.B. (27°C.D.B./19°C.W.B.), Inlet water temperature: 86°F (30°C)	BTU/h =kW x 3.412
2.Nominal heating conditions (Test conditions are based on AHRI 1230) Indoor: 68°F.D.B. (20°C.D.B.), Inlet water temperature: 68°F (20°C)	cfm =m ³ /min x 35.31
	lbs =kg/0.4536
	*Above specification data is subject to rounding variation.

1. SPECIFICATIONS

PQRY-P-T(S)LMU-A1, Y(S)LMU-A1

Heat Source Model		PQRY-P168YSLMU-A1		
Indoor Model		Non-Ducted	Ducted	
Power source		3-phase 3-wire 460 V ±10% 60 Hz		
Cooling capacity (Nominal)	*1	BTU/h	168,000	
		kW	49.2	
	(460)	Power input	kW	9.33
		Current input	A	13.0
	(Rated)		BTU/h	160,000
			kW	46.9
(460)		Power input	kW	8.87
		Current input	A	12.3
Temp. range of cooling	Indoor	W.B.	59~75°F (15~24°C)	
	Inlet water	°F	50~113°F (10~45°C)	
Heating capacity (Nominal)	*2	BTU/h	188,000	
		kW	55.1	
	(460)	Power input	kW	9.34
		Current input	A	13.0
	(Rated)		BTU/h	178,000
			kW	52.2
(460)		Power input	kW	8.53
		Current input	A	11.8
Temp. range of heating	Indoor	D.B.	59~81°F (15~27°C)	
	Inlet water	°F	50~113°F (10~45°C)	
Indoor unit connectable	Total capacity	50~150% of heat source unit capacity		
	Model/Quantity	P04-P96/1~42		
Sound pressure level (measured in anechoic room)	dB <A>	50.0		
Refrigerant piping diameter	High pressure	in. (mm)	7/8 (22.2) Brazed	
	Low pressure	in. (mm)	1-1/8 (28.58) Brazed	

Set Model		PQRY-P96YLMU-A1		PQRY-P72YLMU-A1	
Model		PQRY-P96YLMU-A1		PQRY-P72YLMU-A1	
Minimum Circuit Ampacity		A		6	
Maximum Overcurrent Protection		A		15	
Circulating water	Water flow rate	G/h	1,522 + 1,522		
		G/min	25.4 + 25.4		
		m ³ /h	5.76 + 5.76		
		L/min	96 + 96		
		cfm	3.4 + 3.4		
	Pressure drop	psi	3.48	3.48	
	kPa	24	24		
Operating volume range		G/h	793 + 793 ~ 1,902 + 1,902		
		G/min	13.2 + 13.2 ~ 31.7 + 31.7		
		m ³ /h	3.0 + 3.0 ~ 7.2 + 7.2		
Compressor	Type x Quantity	Inverter scroll hermetic compressor x 1		Inverter scroll hermetic compressor x 1	
	Starting method	Inverter		Inverter	
	Motor output	kW	6.0	4.3	
	Case heater	kW	-	-	
	Lubricant		MEL32	MEL32	
External finish		Galvanized steel sheets		Galvanized steel sheets	
External dimension H x W x D	in.	43-5/16 x 34-11/16 x 21-11/16		43-5/16 x 34-11/16 x 21-11/16	
	mm	1,100 x 880 x 550		1,100 x 880 x 550	
Protection devices	High pressure protection	High pressure sensor, High pressure switch at 4.15 MPa (601 psi)		High pressure sensor, High pressure switch at 4.15 MPa (601 psi)	
	Inverter circuit	Over-heat protection, Over-current protection		Over-heat protection, Over-current protection	
	Compressor	Over-heat protection		Over-heat protection	
Refrigerant	Type x original charge	R410A x 11 lbs + 1 oz (5.0 kg)		R410A x 11 lbs + 1 oz (5.0 kg)	
	Control	Indoor LEV and BC controller			
Net weight	lbs (kg)	406 (184)		406 (184)	
Heat exchanger	Water volume in plate	plate type	plate type		
		G	1.32		
	l	5.0			
	Water pressure Max.	psi	290		
MPa		2.0			
HIC circuit (HIC: Heat Inter-Changer)		-		-	
Pipe between unit and distributor	High pressure	in. (mm)	3/4 (19.05) Brazed		
	Low pressure	in. (mm)	-		
Drawing	External	KL94C221			
	Wiring	KE94G419		KE94G419	
Standard attachment	Document	Installation Manual			
	Accessory	Details refer to External Drw			
Optional parts	Heat Source Twinning kit: CMY-Q100CBK2 joint: CMY-Y102SS-G2, CMY-Y102LS-G2, CMY-R160-J1 Main BC controller: CMB-P108, 1012, 1016NU-JA1, CMB-P1016NU-KA1 Sub BC controller: CMB-P104, 108NU-KB1				
Remarks	Details on foundation work, duct work, insulation work, electrical wiring, power source switch, and other items shall be referred to the Installation Manual. Due to continuing improvement, above specifications may be subject to change without notice. The ambient temperature of the Heat Source Unit needs to be kept below 104°F.D.B. (40°C.D.B.) The ambient relative humidity of the Heat Source Unit needs to be kept below 80%. The Heat Source Unit should not be installed at outdoor. Be sure to mount a strainer (more than 50 meshes) at the water inlet piping of the unit. Be sure to provide interlocking for the unit operation and water circuit. The Heat Source twinning kit (low pressure) should be connected to the low pressure side of the heat source unit. Install the supplied insulation material to the unused drain-socket. When installing insulation material around both water and refrigerant piping, follow the installation manual. The cooling tower and the water circuit must be a closed circuit (water is not exposed to the atmosphere).				

Notes:	Unit converter
1.Nominal cooling conditions (Test conditions are based on AHRI 1230) Indoor: 81°F.D.B./66°F.W.B. (27°C.D.B./19°C.W.B.), Inlet water temperature: 86°F (30°C)	BTU/h =kW x 3,412
2.Nominal heating conditions (Test conditions are based on AHRI 1230) Indoor: 68°F.D.B. (20°C.D.B.), Inlet water temperature: 68°F (20°C)	cfm =m ³ /min x 35.31
	lbs =kg/0.4536
	*Above specification data is subject to rounding variation.

1. SPECIFICATIONS

WR2-Series

PQRY-P-T(S)LMU-A1, Y(S)LMU-A1

Heat Source Model			PQRY-P192YSLMU-A1			
Indoor Model			Non-Ducted		Ducted	
Power source			3-phase 3-wire 460 V ±10% 60 Hz			
Cooling capacity (Nominal)	*1	BTU/h	192,000			
		kW	56.3			
	(460)	Power input	kW	11.30		
			A	15.7		
		(Rated)	BTU/h	184,000		
			kW	53.9		
(460)	Power input	kW	10.84	11.80		
	Current input	A	15.1	16.4		
Temp. range of cooling	Indoor	W.B.	59~75°F (15~24°C)			
	Inlet water	°F	50~113°F (10~45°C)			
Heating capacity (Nominal)	*2	BTU/h	215,000			
		kW	63.0			
	(460)	Power input	kW	11.02		
			A	15.3		
		(Rated)	BTU/h	204,000		
			kW	59.8		
(460)	Power input	kW	10.09	8.93		
	Current input	A	14.0	12.4		
Temp. range of heating	Indoor	D.B.	59~81°F (15~27°C)			
	Inlet water	°F	50~113°F (10~45°C)			
Indoor unit connectable	Total capacity	50~150% of heat source unit capacity				
	Model/Quantity	P04-P96/1-48				
Sound pressure level (measured in anechoic room)	dB <A>	51.0				
Refrigerant piping diameter	High pressure	in. (mm)	7/8 (22.2) Brazed			
	Low pressure	in. (mm)	1-1/8 (28.58) Brazed			

Set Model			PQRY-P96YLMU-A1		PQRY-P96YLMU-A1	
Model			PQRY-P96YLMU-A1		PQRY-P96YLMU-A1	
Minimum Circuit Ampacity	A	9		9		
Maximum Overcurrent Protection	A	15		15		
Circulating water	Water flow rate	G/h	1,522 + 1,522			
		G/min	25.4 + 25.4			
		m ³ /h	5.76 + 5.76			
		L/min	96 + 96			
		cfm	3.4 + 3.4			
	Pressure drop	psi	3.48			3.48
	kPa	24			24	
Operating volume range	G/h	793 + 793 ~ 1,902 + 1,902				
	G/min	13.2 + 13.2 ~ 31.7 + 31.7				
	m ³ /h	3.0 + 3.0 ~ 7.2 + 7.2				
Compressor	Type x Quantity	Inverter scroll hermetic compressor x 1		Inverter scroll hermetic compressor x 1		
	Starting method	Inverter		Inverter		
	Motor output	kW	6.0	6.0		
	Case heater	kW	-	-		
	Lubricant	MEL32		MEL32		
External finish	Galvanized steel sheets		Galvanized steel sheets			
External dimension H x W x D	in.	43-5/16 x 34-11/16 x 21-11/16		43-5/16 x 34-11/16 x 21-11/16		
	mm	1,100 x 880 x 550		1,100 x 880 x 550		
Protection devices	High pressure protection	High pressure sensor, High pressure switch at 4.15 MPa (601 psi)		High pressure sensor, High pressure switch at 4.15 MPa (601 psi)		
	Inverter circuit	Over-heat protection, Over-current protection		Over-heat protection, Over-current protection		
	Compressor	Over-heat protection		Over-heat protection		
Refrigerant	Type x original charge	R410A x 11 lbs + 1 oz (5.0 kg)		R410A x 11 lbs + 1 oz (5.0 kg)		
	Control	Indoor LEV and BC controller				
Net weight	lbs (kg)	406 (184)		406 (184)		
Heat exchanger	Water volume in plate	plate type			plate type	
		G	1.32	1.32		
	I	5.0	5.0			
	Water pressure Max.	psi	290	290		
MPa		2.0	2.0			
HIC circuit (HIC: Heat Inter-Changer)					-	
Pipe between unit and distributor	High pressure	in. (mm)	3/4 (19.05) Brazed		3/4 (19.05) Brazed	
	Low pressure	in. (mm)			7/8 (22.2) Brazed	
Drawing	External	KL94C221				
	Wiring	KE94G419			KE94G419	
Standard attachment	Document	Installation Manual				
	Accessory	Details refer to External Drw				
Optional parts	Heat Source Twinning kit: CMY-Q100CBK2 joint: CMY-Y102SS-G2, CMY-Y102LS-G2, CMY-R160-J1 Main BC controller: CMB-P108, 1012, 1016NU-JA1, CMB-P1016NU-KA1 Sub BC controller: CMB-P104, 108NU-KB1					

Remarks

Details on foundation work, duct work, insulation work, electrical wiring, power source switch, and other items shall be referred to the Installation Manual.

Due to continuing improvement, above specifications may be subject to change without notice.

The ambient temperature of the Heat Source Unit needs to be kept below 104°F.D.B. (40°C.D.B.)

The ambient relative humidity of the Heat Source Unit needs to be kept below 80%.

The Heat Source Unit should not be installed at outdoor.

Be sure to mount a strainer (more than 50 meshes) at the water inlet piping of the unit.

Be sure to provide interlocking for the unit operation and water circuit.

The Heat Source twinning kit (low pressure) should be connected to the low pressure side of the heat source unit.

Install the supplied insulation material to the unused drain-socket.

When installing insulation material around both water and refrigerant piping, follow the installation manual.

The cooling tower and the water circuit must be a closed circuit (water is not exposed to the atmosphere).

Notes:	Unit converter
1.Nominal cooling conditions (Test conditions are based on AHRI 1230) Indoor: 81°F.D.B./66°F.W.B. (27°C.D.B./19°C.W.B.), Inlet water temperature: 86°F (30°C)	BTU/h =kW x 3.412
2.Nominal heating conditions (Test conditions are based on AHRI 1230) Indoor: 68°F.D.B. (20°C.D.B.), Inlet water temperature: 68°F (20°C)	cfm =m ³ /min x 35.31
	lbs =kg/0.4536
	*Above specification data is subject to rounding variation.

1. SPECIFICATIONS

Heat Source Model		PQRY-P216YSLMU-A1		
Indoor Model		Non-Ducted	Ducted	
Power source		3-phase 3-wire 460 V ±10% 60 Hz		
Cooling capacity (Nominal)	*1	BTU/h	216,000	
		kW	63.3	
	(460)	Power input	kW	14.03
		Current input	A	19.5
	(Rated)		BTU/h	206,000
			kW	60.4
(460)	Power input	kW	13.27	
	Current input	A	18.5	
Temp. range of cooling	Indoor	W.B.	59~75°F (15~24°C)	
	Inlet water	°F	50~113°F (10~45°C)	
Heating capacity (Nominal)	*2	BTU/h	243,000	
		kW	71.2	
	(460)	Power input	kW	12.88
		Current input	A	17.9
	(Rated)		BTU/h	232,000
			kW	68.0
(460)	Power input	kW	11.78	
	Current input	A	16.4	
Temp. range of heating	Indoor	D.B.	59~81°F (15~27°C)	
	Inlet water	°F	50~113°F (10~45°C)	
Indoor unit connectable	Total capacity	50~150% of heat source unit capacity		
	Model/Quantity	P04~P96/2~50 (Connectable branch pipe number is max. 48.)		
Sound pressure level (measured in anechoic room)	dB <A>	55.0		
Refrigerant piping diameter	High pressure	7/8 (22.2) Brazed (1-1/8 (28.58) Brazed for the part that exceeds 65 m)		
	Low pressure	1-1/8 (28.58) Brazed		

Set Model		PQRY-P120YLMU-A1		PQRY-P96YLMU-A1	
Model		PQRY-P120YLMU-A1		PQRY-P96YLMU-A1	
Minimum Circuit Ampacity		A	13	9	
Maximum Overcurrent Protection		A	20	15	
Circulating water	Water flow rate	G/h	1,522 + 1,522		
		G/min	25.4 + 25.4		
		m ³ /h	5.76 + 5.76		
		L/min	96 + 96		
		cfm	3.4 + 3.4		
	Pressure drop	psi	3.48	3.48	
	kPa	24	24		
Operating volume range	G/h	793 + 793 ~ 1,902 + 1,902			
	G/min	13.2 + 13.2 ~ 31.7 + 31.7			
	m ³ /h	3.0 + 3.0 ~ 7.2 + 7.2			
Compressor	Type x Quantity	Inverter scroll hermetic compressor x 1		Inverter scroll hermetic compressor x 1	
	Starting method	Inverter		Inverter	
	Motor output	kW	7.7	6.0	
	Case heater	kW	-	-	
	Lubricant		MEL32	MEL32	
External finish		Galvanized steel sheets		Galvanized steel sheets	
External dimension H x W x D	in.	43-5/16 x 34-11/16 x 21-11/16		43-5/16 x 34-11/16 x 21-11/16	
	mm	1,100 x 880 x 550		1,100 x 880 x 550	
Protection devices	High pressure protection	High pressure sensor, High pressure switch at 4.15 MPa (601 psi)		High pressure sensor, High pressure switch at 4.15 MPa (601 psi)	
	Inverter circuit	Over-heat protection, Over-current protection		Over-heat protection, Over-current protection	
	Compressor	Over-heat protection		Over-heat protection	
Refrigerant	Type x original charge	R410A x 11 lbs + 1 oz (5.0 kg)		R410A x 11 lbs + 1 oz (5.0 kg)	
	Control	Indoor LEV and BC controller			
Net weight	lbs (kg)	406 (184)		406 (184)	
Heat exchanger	Water volume in plate	plate type	plate type		
		G	1.32		
	l	5.0			
	Water pressure Max.	psi	290		
MPa		2.0			
HIC circuit (HIC: Heat Inter-Changer)		-		-	
Pipe between unit and distributor	High pressure	in. (mm)	3/4 (19.05) Brazed		
	Low pressure	in. (mm)	-		
Drawing	External	KL94C221			
	Wiring	KE94G419		KE94G419	
Standard attachment	Document	Installation Manual			
	Accessory	Details refer to External Drw			
Optional parts	Heat Source Twinning kit: CMY-Q100CBK2 joint: CMY-Y102SS-G2, CMY-Y102LS-G2, CMY-R160-J1 Main BC controller: CMB-P108, 1012, 1016NU-JA1, CMB-P1016NU-KA1 Sub BC controller: CMB-P104, 108NU-KB1				
Remarks	<p>Details on foundation work, duct work, insulation work, electrical wiring, power source switch, and other items shall be referred to the Installation Manual.</p> <p>Due to continuing improvement, above specifications may be subject to change without notice.</p> <p>The ambient temperature of the Heat Source Unit needs to be kept below 104°F.D.B. (40°C.D.B.)</p> <p>The ambient relative humidity of the Heat Source Unit needs to be kept below 80%.</p> <p>The Heat Source Unit should not be installed at outdoor.</p> <p>Be sure to mount a strainer (more than 50 meshes) at the water inlet piping of the unit.</p> <p>Be sure to provide interlocking for the unit operation and water circuit.</p> <p>The Heat Source twinning kit (low pressure) should be connected to the low pressure side of the heat source unit.</p> <p>Install the supplied insulation material to the unused drain-socket.</p> <p>When installing insulation material around both water and refrigerant piping, follow the installation manual.</p> <p>When the high pressure piping length is 65 m or less, use 7/8 (22.2) pipe. When the high pressure piping length exceeds 65 m, use 1-1/8 (28.58) pipe until 65 m, use 1-1/8 (28.58) pipe for the part that exceeds 65 m.</p> <p>The cooling tower and the water circuit must be a closed circuit (water is not exposed to the atmosphere).</p>				

Notes:	Unit converter
1. Nominal cooling conditions (Test conditions are based on AHRI 1230) Indoor: 81°F.D.B./66°F.W.B. (27°C.D.B./19°C.W.B.), Inlet water temperature: 86°F (30°C)	BTU/h =kW x 3,412
2. Nominal heating conditions (Test conditions are based on AHRI 1230) Indoor: 68°F.D.B. (20°C.D.B.), Inlet water temperature: 68°F (20°C)	cfm =m ³ /min x 35.31
	lbs =kg/0.4536
	*Above specification data is subject to rounding variation.

1. SPECIFICATIONS

WR2-Series

PQRY-P-T(S)LMU-A1, Y(S)LMU-A1

Heat Source Model			PQRY-P240YSLMU-A1		
Indoor Model			Non-Ducted	Ducted	
Power source			3-phase 3-wire 460 V ±10% 60 Hz		
Cooling capacity (Nominal)	*1	BTU/h	240,000		
		kW	70.3		
	(460)	Power input	kW	16.89	
		Current input	A	23.5	
	(Rated)	(460)	BTU/h	230,000	
			kW	67.4	
(460)	Power input	kW	16.08	17.37	
	Current input	A	22.4	24.2	
Temp. range of cooling	Indoor	W.B.	59~75°F (15~24°C)		
	Inlet water	°F	50~113°F (10~45°C)		
Heating capacity (Nominal)	*2	BTU/h	270,000		
		kW	79.1		
	(460)	Power input	kW	14.58	
		Current input	A	20.3	
	(Rated)	(460)	BTU/h	258,000	
			kW	75.6	
(460)	Power input	kW	13.40	11.67	
	Current input	A	18.6	16.2	
Temp. range of heating	Indoor	D.B.	59~81°F (15~27°C)		
	Inlet water	°F	50~113°F (10~45°C)		
Indoor unit connectable	Total capacity	50~150% of heat source unit capacity			
	Model/Quantity	P04~P96/2~50 (Connectable branch pipe number is max. 48.)			
Sound pressure level (measured in anechoic room)	dB <A>	57.0			
Refrigerant piping diameter	High pressure	in. (mm)	7/8 (22.2) Brazed (1-1/8 (28.58) Brazed for the part that exceeds 65 m)		
	Low pressure	in. (mm)	1-3/8 (34.93) Brazed		

Set Model			PQRY-P120YLMU-A1	
Model			PQRY-P120YLMU-A1	PQRY-P120YLMU-A1
Minimum Circuit Ampacity			A	13
Maximum Overcurrent Protection			A	20
Circulating water	Water flow rate	G/h	1,522 + 1,522	
		G/min	25.4 + 25.4	
		m ³ /h	5.76 + 5.76	
		L/min	96 + 96	
		cfm	3.4 + 3.4	
	Pressure drop	psi	3.48	3.48
Operating volume range	kPa		24	24
		G/h	793 + 793 ~ 1,902 + 1,902	
	G/min	13.2 + 13.2 ~ 31.7 + 31.7		
	m ³ /h	3.0 + 3.0 ~ 7.2 + 7.2		
Compressor	Type x Quantity	Inverter scroll hermetic compressor x 1		Inverter scroll hermetic compressor x 1
	Starting method	Inverter		Inverter
	Motor output	kW	7.7	7.7
	Case heater	kW	-	-
	Lubricant		MEL32	MEL32
External finish			Galvanized steel sheets	
External dimension H x W x D	in.	43-5/16 x 34-11/16 x 21-11/16		43-5/16 x 34-11/16 x 21-11/16
	mm	1,100 x 880 x 550		1,100 x 880 x 550
Protection devices	High pressure protection	High pressure sensor, High pressure switch at 4.15 MPa (601 psi)		High pressure sensor, High pressure switch at 4.15 MPa (601 psi)
	Inverter circuit	Over-heat protection, Over-current protection		Over-heat protection, Over-current protection
	Compressor	Over-heat protection		Over-heat protection
Refrigerant	Type x original charge	R410A x 11 lbs + 1 oz (5.0 kg)		R410A x 11 lbs + 1 oz (5.0 kg)
	Control	Indoor LEV and BC controller		
Net weight	lbs (kg)	406 (184)		406 (184)
Heat exchanger	Water volume in plate	plate type	plate type	
		G	1.32	1.32
	l	5.0	5.0	
	Water pressure Max.	psi	290	290
	MPa	2.0	2.0	
HIC circuit (HIC: Heat Inter-Changer)			-	
Pipe between unit and distributor	High pressure	in. (mm)	3/4 (19.05) Brazed	
	Low pressure	in. (mm)	-	
Drawing	External	KL94C221		
	Wiring	KE94G419	KE94G419	
Standard attachment	Document	Installation Manual		
	Accessory	Details refer to External Drw		
Optional parts	Heat Source Twinning kit: CMY-Q100CBK2 joint: CMY-Y102SS-G2, CMY-Y102LS-G2, CMY-R160-J1 Main BC controller: CMB-P108, 1012, 1016NU-JA1, CMB-P1016NU-KA1 Sub BC controller: CMB-P104, 108NU-KB1			
Remarks	<p>Details on foundation work, duct work, insulation work, electrical wiring, power source switch, and other items shall be referred to the Installation Manual.</p> <p>Due to continuing improvement, above specifications may be subject to change without notice.</p> <p>The ambient temperature of the Heat Source Unit needs to be kept below 104°F D.B. (40°C D.B.)</p> <p>The ambient relative humidity of the Heat Source Unit needs to be kept below 80%.</p> <p>The Heat Source Unit should not be installed at outdoor.</p> <p>Be sure to mount a strainer (more than 50 meshes) at the water inlet piping of the unit.</p> <p>Be sure to provide interlocking for the unit operation and water circuit.</p> <p>The Heat Source twinning kit (low pressure) should be connected to the low pressure side of the heat source unit.</p> <p>Install the supplied insulation material to the unused drain-socket.</p> <p>When installing insulation material around both water and refrigerant piping, follow the installation manual.</p> <p>When the high pressure piping length is 65 m or less, use 7/8 (22.2) pipe. When the high pressure piping length exceeds 65 m, use 1-1/8 (28.58) pipe until 65 m, use 1-1/8 (28.58) pipe for the part that exceeds 65 m.</p> <p>The cooling tower and the water circuit must be a closed circuit (water is not exposed to the atmosphere).</p>			

Notes:	Unit converter
1. Nominal cooling conditions (Test conditions are based on AHRI 1230) Indoor: 81°F D.B./66°F W.B. (27°C D.B./19°C W.B.), Inlet water temperature: 86°F (30°C)	BTU/h = kW x 3.412
2. Nominal heating conditions (Test conditions are based on AHRI 1230) Indoor: 68°F D.B. (20°C D.B.), Inlet water temperature: 68°F (20°C)	cfm = m ³ /min x 35.31
	lbs = kg/0.4536
	*Above specification data is subject to rounding variation.

1. SPECIFICATIONS

Heat Source Model		PQRY-P288YSLMU-A1		
Indoor Model		Non-Ducted	Ducted	
Power source		3-phase 3-wire 460 V ±10% 60 Hz		
Cooling capacity (Nominal)	*1	BTU/h	288,000	
		kW	84.4	
	(460)	Power input	kW	20.42
		Current input	A	28.4
	(Rated)		BTU/h	276,000
			kW	80.9
(460)		Power input	kW	20.11
		Current input	A	28.0
Temp. range of cooling	Indoor	W.B.	59~75°F (15~24°C)	
	Inlet water	°F	50~113°F (10~45°C)	
Heating capacity (Nominal)	*2	BTU/h	323,000	
		kW	94.7	
	(460)	Power input	kW	17.50
		Current input	A	24.4
	(Rated)		BTU/h	304,000
			kW	89.1
(460)		Power input	kW	15.83
		Current input	A	22.0
Temp. range of heating	Indoor	D.B.	59~81°F (15~27°C)	
	Inlet water	°F	50~113°F (10~45°C)	
Indoor unit connectable	Total capacity	50~150% of heat source unit capacity		
	Model/Quantity	P04~P96/2~50 (Connectable branch pipe number is max. 48.)		
Sound pressure level (measured in anechoic room)	dB <A>	57.0		
Refrigerant piping diameter	High pressure	in. (mm)	1-1/8 (28.58) Brazed	
	Low pressure	in. (mm)	1-3/8 (34.93) Brazed	

Set Model		PQRY-P144YLMU-A1		PQRY-P144YLMU-A1	
Model		PQRY-P144YLMU-A1		PQRY-P144YLMU-A1	
Minimum Circuit Ampacity		A	16	16	
Maximum Overcurrent Protection		A	25	25	
Circulating water	Water flow rate	G/h	1,902 + 1,902		
		G/min	31.7 + 31.7		
		m ³ /h	7.20 + 7.20		
		L/min	120 + 120		
		cfm	4.2 + 4.2		
	Pressure drop	psi	6.38	6.38	
	kPa	44	44		
Operating volume range	G/h	1,189 + 1,189 ~ 3,054 + 3,054			
		19.8 + 19.8 ~ 50.9 + 50.9			
		4.5 + 4.5 ~ 11.6 + 11.6			
Compressor	Type x Quantity	Inverter scroll hermetic compressor x 1		Inverter scroll hermetic compressor x 1	
	Starting method	Inverter		Inverter	
	Motor output	kW	9.5	9.5	
	Case heater	kW	-	-	
	Lubricant		MEL32	MEL32	
External finish		Galvanized steel sheets		Galvanized steel sheets	
External dimension H x W x D	in.	57-1/8 x 34-11/16 x 21-11/16		57-1/8 x 34-11/16 x 21-11/16	
	mm	1,450 x 880 x 550		1,450 x 880 x 550	
Protection devices	High pressure protection	High pressure sensor, High pressure switch at 4.15 MPa (601 psi)		High pressure sensor, High pressure switch at 4.15 MPa (601 psi)	
	Inverter circuit	Over-heat protection, Over-current protection		Over-heat protection, Over-current protection	
	Compressor	Over-heat protection		Over-heat protection	
Refrigerant	Type x original charge	R410A x 13 lbs + 4 oz (6.0 kg)		R410A x 13 lbs + 4 oz (6.0 kg)	
	Control	Indoor LEV and BC controller			
Net weight	lbs (kg)	508 (230)		508 (230)	
Heat exchanger	Water volume in plate	plate type			plate type
		G	1.32		1.32
	l	5.0		5.0	
	Water pressure Max.	psi	290		290
MPa		2.0		2.0	
HIC circuit (HIC: Heat Inter-Changer)		-		-	
Pipe between unit and distributor	High pressure	in. (mm)	7/8 (22.2) Brazed		7/8 (22.2) Brazed
	Low pressure	in. (mm)	-		1-1/8 (28.58) Brazed
Drawing	External	KL94C222		KL94C222	
	Wiring	KE94G419		KE94G419	
Standard attachment	Document	Installation Manual			
	Accessory	Details refer to External Drw			
Optional parts	Heat Source Twinning kit: CMY-Q200CBK joint: CMY-Y102SS-G2, CMY-Y102LS-G2, CMY-R160-J1 Main BC controller: CMB-P108, 1012, 1016NU-JA1, CMB-P1016NU-KA1 Sub BC controller: CMB-P104, 108NU-KB1				
Remarks	Details on foundation work, duct work, insulation work, electrical wiring, power source switch, and other items shall be referred to the Installation Manual. Due to continuing improvement, above specifications may be subject to change without notice. The ambient temperature of the Heat Source Unit needs to be kept below 104°F.D.B. (40°C.D.B.) The ambient relative humidity of the Heat Source Unit needs to be kept below 80%. The Heat Source Unit should not be installed at outdoor. Be sure to mount a strainer (more than 50 meshes) at the water inlet piping of the unit. Be sure to provide interlocking for the unit operation and water circuit. The Heat Source twinning kit (low pressure) should be connected to the low pressure side of the heat source unit. Install the supplied insulation material to the unused drain-socket. When installing insulation material around both water and refrigerant piping, follow the installation manual. The cooling tower and the water circuit must be a closed circuit (water is not exposed to the atmosphere).				

Notes:	Unit converter
1.Nominal cooling conditions (Test conditions are based on AHRI 1230) Indoor: 81°F.D.B./66°F.W.B. (27°C.D.B./19°C.W.B.), Inlet water temperature: 86°F (30°C)	BTU/h =kW x 3,412
2.Nominal heating conditions (Test conditions are based on AHRI 1230) Indoor: 68°F.D.B. (20°C.D.B.), Inlet water temperature: 68°F (20°C)	cfm =m ³ /min x 35.31
	lbs =kg/0.4536
	*Above specification data is subject to rounding variation.

1. SPECIFICATIONS

WR2-Series

PQRY-P-T(S)LMU-A1, Y(S)LMU-A1

Heat Source Model			PQRY-P312YSLMU-A1			
Indoor Model			Non-Ducted		Ducted	
Power source			3-phase 3-wire 460 V ±10% 60 Hz			
Cooling capacity (Nominal)	*1	BTU/h	312,000			
		kW	91.4			
	(460)	Power input	23.41			
		Current input	32.6			
	(Rated)		BTU/h	298,000		
			kW	87.3		
(460)	Power input	22.45	24.98			
	Current input	31.3	34.8			
Temp. range of cooling	Indoor	W.B.	59~75°F (15~24°C)			
	Inlet water	°F	50~113°F (10~45°C)			
Heating capacity (Nominal)	*2	BTU/h	350,000			
		kW	102.6			
	(460)	Power input	19.11			
		Current input	26.6			
	(Rated)		BTU/h	334,000		
			kW	97.9		
(460)	Power input	17.48	17.49			
	Current input	24.3	24.3			
Temp. range of heating	Indoor	D.B.	59~81°F (15~27°C)			
	Inlet water	°F	50~113°F (10~45°C)			
Indoor unit connectable	Total capacity	50~150% of heat source unit capacity				
	Model/Quantity	P04~P96/2~50 (Connectable branch pipe number is max. 48.)				
Sound pressure level (measured in anechoic room)	dB <A>	58.0				
Refrigerant piping diameter	High pressure	in. (mm)	1-1/8 (28.58) Brazed			
	Low pressure	in. (mm)	1-3/8 (34.93) Brazed			

Set Model			PQRY-P168YLMU-A1		PQRY-P144YLMU-A1
Model			PQRY-P168YLMU-A1		PQRY-P144YLMU-A1
Minimum Circuit Ampacity			A		16
Maximum Overcurrent Protection			A		25
Circulating water	Water flow rate	G/h	1,902 + 1,902		
		G/min	31.7 + 31.7		
		m ³ /h	7.20 + 7.20		
		L/min	120 + 120		
		cfm	4.2 + 4.2		
	Pressure drop	psi	6.38	6.38	
	kPa	44	44		
Operating volume range	G/h	1,189 + 1,189 ~ 3,054 + 3,054			
	G/min	19.8 + 19.8 ~ 50.9 + 50.9			
	m ³ /h	4.5 + 4.5 ~ 11.6 + 11.6			
Compressor	Type x Quantity	Inverter scroll hermetic compressor x 1		Inverter scroll hermetic compressor x 1	
	Starting method	Inverter		Inverter	
	Motor output	kW	11.0	9.5	
	Case heater	kW	-	-	
	Lubricant		MEL32	MEL32	
External finish			Galvanized steel sheets		Galvanized steel sheets
External dimension H x W x D			in.		57-1/8 x 34-11/16 x 21-11/16
			mm		1,450 x 880 x 550
Protection devices	High pressure protection	High pressure sensor, High pressure switch at 4.15 MPa (601 psi)		High pressure sensor, High pressure switch at 4.15 MPa (601 psi)	
	Inverter circuit	Over-heat protection, Over-current protection		Over-heat protection, Over-current protection	
	Compressor	Over-heat protection		Over-heat protection	
Refrigerant	Type x original charge	R410A x 13 lbs + 4 oz (6.0 kg)		R410A x 13 lbs + 4 oz (6.0 kg)	
	Control	Indoor LEV and BC controller			
Net weight			lbs (kg)		508 (230)
Heat exchanger	Water volume in plate	plate type	plate type		
		G	1.32		
	I	5.0			
	Water pressure Max.	psi	290		
	MPa	2.0			
HIC circuit (HIC: Heat Inter-Changer)			-		-
Pipe between unit and distributor	High pressure	in. (mm)	7/8 (22.2) Brazed		7/8 (22.2) Brazed
	Low pressure	in. (mm)	-		1-1/8 (28.58) Brazed
Drawing	External	KL94C222			
	Wiring	KE94G419		KE94G419	
Standard attachment	Document	Installation Manual			
	Accessory	Details refer to External Drw			
Optional parts			Heat Source Twinning kit: CMY-Q200CBK joint: CMY-Y102SS-G2, CMY-Y102LS-G2, CMY-R160-J1 Main BC controller: CMB-P108, 1012, 1016NU-JA1, CMB-P1016NU-KA1 Sub BC controller: CMB-P104, 108NU-KB1		
Remarks			<p>Details on foundation work, duct work, insulation work, electrical wiring, power source switch, and other items shall be referred to the Installation Manual.</p> <p>Due to continuing improvement, above specifications may be subject to change without notice.</p> <p>The ambient temperature of the Heat Source Unit needs to be kept below 104°F.D.B. (40°C.D.B.)</p> <p>The ambient relative humidity of the Heat Source Unit needs to be kept below 80%.</p> <p>The Heat Source Unit should not be installed at outdoor.</p> <p>Be sure to mount a strainer (more than 50 meshes) at the water inlet piping of the unit.</p> <p>Be sure to provide interlocking for the unit operation and water circuit.</p> <p>The Heat Source twinning kit (low pressure) should be connected to the low pressure side of the heat source unit.</p> <p>Install the supplied insulation material to the unused drain-socket.</p> <p>When installing insulation material around both water and refrigerant piping, follow the installation manual.</p> <p>The cooling tower and the water circuit must be a closed circuit (water is not exposed to the atmosphere).</p>		

Notes:	Unit converter
1. Nominal cooling conditions (Test conditions are based on AHRI 1230) Indoor: 81°F.D.B./66°F.W.B. (27°C.D.B./19°C.W.B.), Inlet water temperature: 86°F (30°C)	BTU/h =kW x 3.412
2. Nominal heating conditions (Test conditions are based on AHRI 1230) Indoor: 68°F.D.B. (20°C.D.B.), Inlet water temperature: 68°F (20°C)	cfm =m ³ /min x 35.31
	lbs =kg/0.4536
	*Above specification data is subject to rounding variation.

1. SPECIFICATIONS

Heat Source Model		PQRY-P336YSLMU-A1		
Indoor Model		Non-Ducted	Ducted	
Power source		3-phase 3-wire 460 V ±10% 60 Hz		
Cooling capacity (Nominal)	*1	BTU/h	336,000	
		kW	98.5	
	(460)	Power input	kW	26.84
		Current input	A	37.4
	(Rated)		BTU/h	320,000
			kW	93.8
(460)	Power input	kW	25.14	
	Current input	A	35.0	
Temp. range of cooling	Indoor	W.B.	59~75°F (15~24°C)	
	Inlet water	°F	50~113°F (10~45°C)	
Heating capacity (Nominal)	*2	BTU/h	378,000	
		kW	110.8	
	(460)	Power input	kW	20.77
		Current input	A	28.9
	(Rated)		BTU/h	360,000
			kW	105.5
(460)	Power input	kW	18.91	
	Current input	A	26.3	
Temp. range of heating	Indoor	D.B.	59~81°F (15~27°C)	
	Inlet water	°F	50~113°F (10~45°C)	
Indoor unit connectable	Total capacity	50~150% of heat source unit capacity		
	Model/Quantity	P04~P96/2~50 (Connectable branch pipe number is max. 48.)		
Sound pressure level (measured in anechoic room)	dB <A>	59.0		
Refrigerant piping diameter	High pressure	in. (mm)	1-1/8 (28.58) Brazed	
	Low pressure	in. (mm)	1-5/8 (41.28) Brazed	

Set Model		PQRY-P168YLMU-A1	
Model		PQRY-P168YLMU-A1	PQRY-P168YLMU-A1
Minimum Circuit Ampacity	A	20	20
Maximum Overcurrent Protection	A	35	35
Circulating water	Water flow rate	G/h	1,902 + 1,902
		G/min	31.7 + 31.7
		m ³ /h	7.20 + 7.20
		L/min	120 + 120
		cfm	4.2 + 4.2
	Pressure drop	psi	6.38
	kPa	44	
Operating volume range	G/h	1,189 + 1,189 ~ 3,054 + 3,054	
	G/min	19.8 + 19.8 ~ 50.9 + 50.9	
	m ³ /h	4.5 + 4.5 ~ 11.6 + 11.6	
Compressor	Type x Quantity	Inverter scroll hermetic compressor x 1	Inverter scroll hermetic compressor x 1
	Starting method	Inverter	Inverter
	Motor output	kW	11.0
	Case heater	kW	-
	Lubricant		MEL32
External finish		Galvanized steel sheets	Galvanized steel sheets
External dimension H x W x D	in.	57-1/8 x 34-11/16 x 21-11/16	57-1/8 x 34-11/16 x 21-11/16
	mm	1,450 x 880 x 550	1,450 x 880 x 550
Protection devices	High pressure protection	High pressure sensor, High pressure switch at 4.15 MPa (601 psi)	High pressure sensor, High pressure switch at 4.15 MPa (601 psi)
	Inverter circuit	Over-heat protection, Over-current protection	Over-heat protection, Over-current protection
	Compressor	Over-heat protection	Over-heat protection
Refrigerant	Type x original charge	R410A x 13 lbs + 4 oz (6.0 kg)	R410A x 13 lbs + 4 oz (6.0 kg)
	Control	Indoor LEV and BC controller	
Net weight	lbs (kg)	508 (230)	508 (230)
Heat exchanger	Water volume in plate	plate type	plate type
		G	1.32
	l	5.0	
	Water pressure Max.	psi	290
MPa		2.0	
HIC circuit (HIC: Heat Inter-Changer)		-	-
Pipe between unit and distributor	High pressure	in. (mm)	7/8 (22.2) Brazed
	Low pressure	in. (mm)	-
Drawing	External	KL94C222	
	Wiring	KE94G419	KE94G419
Standard attachment	Document	Installation Manual	
	Accessory	Details refer to External Drw	
Optional parts		Heat Source Twinning kit: CMY-Q200CBK joint: CMY-Y102SS-G2, CMY-Y102LS-G2, CMY-R160-J1 Main BC controller: CMB-P108, 1012, 1016NU-JA1, CMB-P1016NU-KA1 Sub BC controller: CMB-P104, 108NU-KB1	
Remarks		Details on foundation work, duct work, insulation work, electrical wiring, power source switch, and other items shall be referred to the Installation Manual. Due to continuing improvement, above specifications may be subject to change without notice. The ambient temperature of the Heat Source Unit needs to be kept below 104°F.D.B. (40°C.D.B.) The ambient relative humidity of the Heat Source Unit needs to be kept below 80%. The Heat Source Unit should not be installed at outdoor. Be sure to mount a strainer (more than 50 meshes) at the water inlet piping of the unit. Be sure to provide interlocking for the unit operation and water circuit. The Heat Source twinning kit (low pressure) should be connected to the low pressure side of the heat source unit. Install the supplied insulation material to the unused drain-socket. When installing insulation material around both water and refrigerant piping, follow the installation manual. The cooling tower and the water circuit must be a closed circuit (water is not exposed to the atmosphere).	

Notes:	Unit converter
1.Nominal cooling conditions (Test conditions are based on AHRI 1230) Indoor: 81°F.D.B./66°F.W.B. (27°C.D.B./19°C.W.B.), Inlet water temperature: 86°F (30°C)	BTU/h =kW x 3,412
2.Nominal heating conditions (Test conditions are based on AHRI 1230) Indoor: 68°F.D.B. (20°C.D.B.), Inlet water temperature: 68°F (20°C)	cfm =m ³ /min x 35.31
	lbs =kg/0.4536
	*Above specification data is subject to rounding variation.

PQRY-P72, 96, 120TLMU-A1

Unit: mm(in)

<Accessories>

- Refrigerant (high pressure) conn. pipe.....1pc. (P72/P96/P120 ; Packaged in the accessory kit)
- Refrigerant (low pressure) conn. elbow.....1pc. (P72/P96/P120 ; Packaged in the accessory kit)
- Water stopper.....1pc. (P72/P96/P120 ; Packaged in the accessory kit)
- Sealing material for water stopper.....1pc. (P72/P96/P120 ; Packaged in the accessory kit)
- Sealing material for field piping (high pressure, low pressure).....1pc. each (P72/P96/P120 ; Packaged in the accessory kit)
- Sealing material for drain socket.....1pc. (P72/P96/P120 ; Packaged in the accessory kit)
- Pipe cover for low pressure.....1pc. (P72/P96/P120 ; Packaged in the accessory kit)

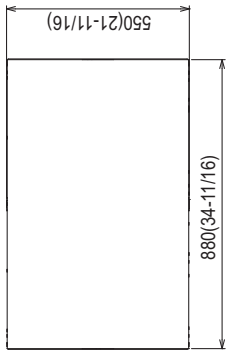

Top view

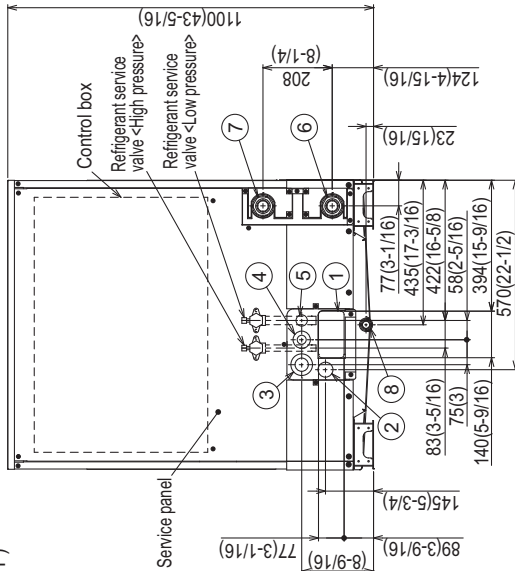

Front view

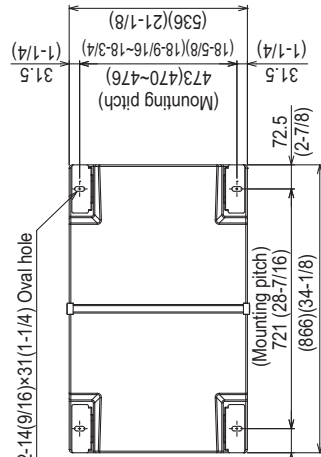

Bottom view

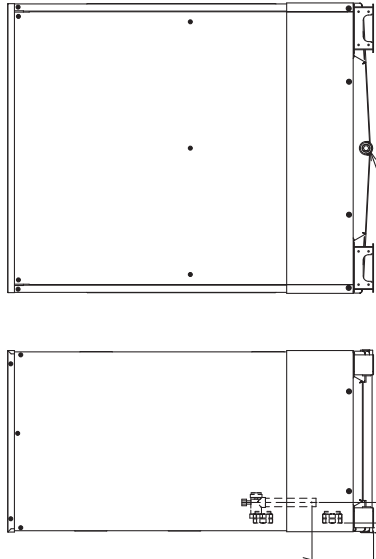

Right side view

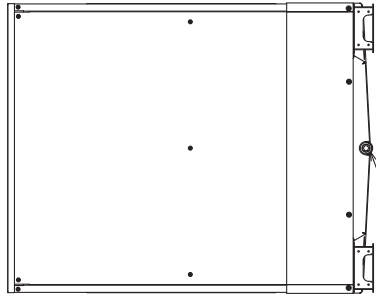

Back view

NO.	Usage	Specifications
①	Front through hole	140 x 77 Knockout hole (5-9/16) (3-1/16)
②	For pipes	Front through hole (Uses when winning kit (optional parts) is mounted.) (1-13/16)
③	For wires	Front through hole (2-1/2) or ø34.5 Knockout hole (1-3/8)
④	For transmission cables	Front through hole ø43.7 or ø22.2 Knockout hole (1-3/4) (7/8)
⑤	For transmission cables	Front through hole ø34 Knockout hole (1-3/8)
⑥	Water pipe inlet	NPT1-1/2 Screw
⑦	Water pipe outlet	NPT1-1/2 Screw
⑧	Drain pipe	Rc3/4 Screw

Note1. Close a hole of the water piping, the refrigerant piping, the power supply, and the control wiring and unused knockout holes with the putty etc. so as not to infiltrate rain water etc.(field erection work)

Note2. At the time of product shipment, the front side piping specification serves as the local drainage connection. When connecting on the rear side, please remove the rear side plug sealing corks, and attach a front side. Ensure there is no leak after the attachment has been fitted.

Note3. Take notice of service space as Fig.A. (In case of single installation, 60mm(23-5/8) or more of back space as front space makes easier access when servicing the unit from rear side.)

Note4. If water pipes or refrigerant pipes stretch upward, required space for service and maintenance due to replacement of control box is shown in Fig.B.

Note5. Environmental condition for installation; -20~40°C(DB) (-4~104°F) as indoor installation.

Note6. In case the temperature around the heat source unit has possibility to drop under 0°C(32°F), be careful for the following point to prevent the pipe burst by the water pipe freeze-up.

Note7. Drain the water from inside of the heat source unit when the heat source unit will not operate for a long term. Ensure that the drain piping is downward with a pitch of more than 1/100.

Note8. At brazing of pipes, wrap the refrigerant service valve with wet cloth and keep the temperature of refrigerant service valve under 120°C(248°F).

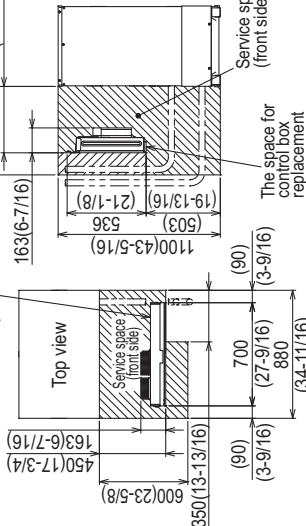

Fig.A

Fig.B

Model	Refrigerant pipe		Service valve	
	High pressure	Low pressure	High pressure	Low pressure
PQRY-P72TLMU-A1	ø15.88 Brazed (5/8) *1 *2	ø19.05 Brazed (3/4) *1 *2	ø19.05 (3/4)	ø25.4 (1)
PQRY-P96TLMU-A1	ø19.05 Brazed (3/4) *1	ø22.2 Brazed (7/8) *1 *2		
PQRY-P120TLMU-A1				

*1. Connect by using the connecting pipes and elbow that are supplied.
*2. Use the pipe joint(field supply) and connect to the refrigerant service valve piping.

PQRY-P144, 168, 192TLMU-A1

Unit: mm(in)

- <Accessories>
- Refrigerant (high pressure) conn. pipe..... 1pc.
(P144/P168/P192; Packaged in the accessory kit)
 - Refrigerant (low pressure) conn. pipe..... 1pc.
(P144/P168/P192; Packaged in the accessory kit)
 - Water stopper..... 1pc.
(P144/P168/P192; Packaged in the accessory kit)
 - Sealing material for water stopper..... 1pc.
(P144/P168/P192; Packaged in the accessory kit)
 - Sealing material for field piping (high pressure, low pressure)..... 4pc. each
(P144/P168/P192; Packaged in the accessory kit)
 - Sealing material for drain socket..... 1pc.
(P144/P168/P192; Packaged in the accessory kit)
 - Pipe cover for low pressure..... 1pc.
(P144/P168/P192; Packaged in the accessory kit)
 - Sealing material for base leg (two types)..... 4pc. each
(P144/P168/P192; Packaged in the accessory kit)
 - Sealing material for panel..... 1pc.
(P144/P168/P192; Packaged in the accessory kit)

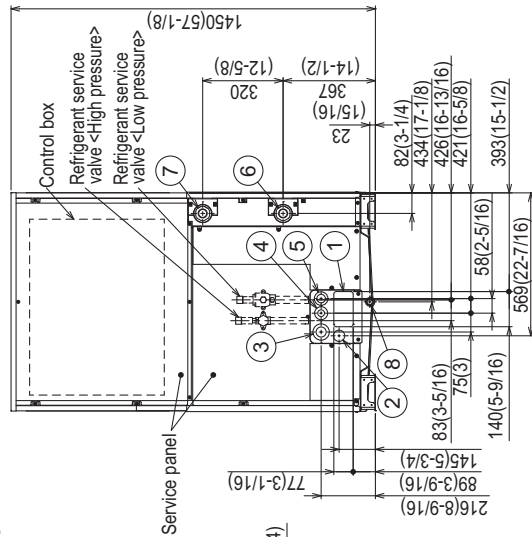
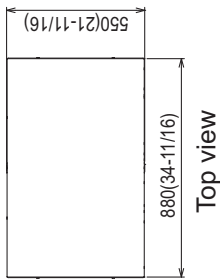

Front view

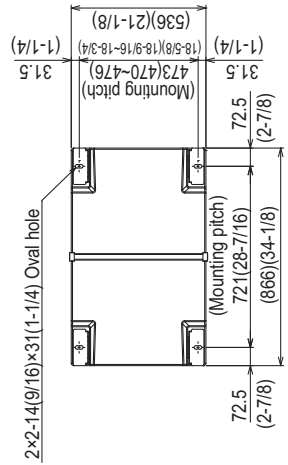

Bottom view

- Note 1. Close a hole of the water piping, the refrigerant piping, the power supply, and the control wiring and unused knockout holes with the putty etc. so as not to infiltrate rain water etc.(field erection work)
- Note 2. At the time of product shipment, the front side piping specification serves as the local drainage connection. When connecting on the rear side, please remove the rear side plug sealing corks, and attach a front side. Ensure there is no leak after the attachment has been fitted.
- Note 3. Take notice of service space as Fig.A. (In case of single installation, 600mm(23-5/8) or more of back space as front space makes easier access when servicing the unit from rear side.)
- Note 4. If water pipes or refrigerant pipes stretch upward, required space for service and maintenance due to replacement of control box is shown in Fig.B.
- Note 5. Environmental condition for installation; -20~40°C(DB) (-4~104°F) as indoor installation.
- Note 6. In case the temperature around the heat source unit has possibility to drop under 0°C(32°F), be careful for the following point to prevent the pipe burst by the water pipe freeze-up.
- Circulate the water all the time even if the heat source unit is not in operation.
 - Drain the water from inside of the heat source unit when the heat source unit will not operate for a long term.
- Note 7. Ensure that the drain piping is downward with a pitch of more than 1/100.
- Note 8. At brazing of pipes, wrap the refrigerant service valve with wet cloth and keep the temperature of refrigerant service valve under 120°C(248°F).

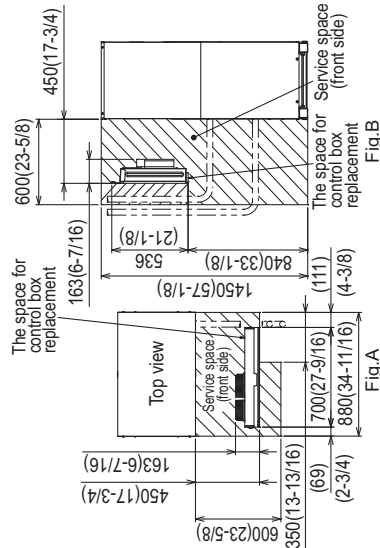

Fig.A

Fig.B

Connecting pipe specifications

Model	Refrigerant pipe		Service valve	
	High pressure	Low pressure	High pressure	Low pressure
PQRY-P144TLMU-A1	ø22.2 Braze	ø28.58 Braze	ø25.4 (1-1/8) *1	ø28.58 (1-1/8)
PQRY-P168TLMU-A1	ø22.2 Braze	ø28.58 Braze	ø25.4 (1-1/8) *1	ø28.58 (1-1/8)
PQRY-P192TLMU-A1	ø22.2 Braze	ø28.58 Braze	ø25.4 (1-1/8) *1	ø28.58 (1-1/8)

*1. Connect by using the connecting pipes that are supplied.

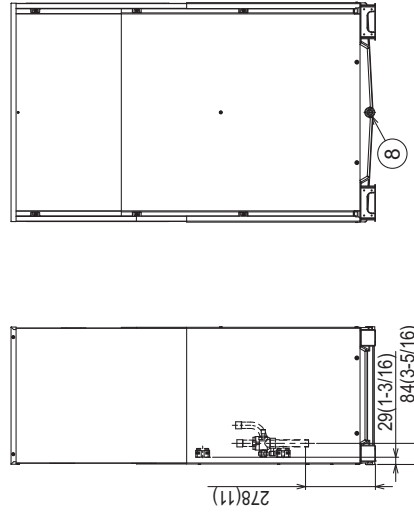

Right side view

Back view

NO.	Usage	Specifications
①	Front through hole	140 x 77 Knockout hole (5-9/16) (3-1/16)
②	For pipes	Front through hole (Uses when twinning kit (optional parts) is mounted.) ø45 Knockout hole (1-13/16)
③	For wires	Front through hole ø62.7 or ø34.5 Knockout hole (2-1/2) (1-3/8)
④	For transmission cables	Front through hole ø43.7 or ø22.2 Knockout hole (1-3/4) (7/8)
⑤	Water pipe inlet	ø34 Knockout hole (1-3/8)
⑥	Water pipe outlet	NPT1-1/2 Screw
⑦	Drain pipe	Rc3/4 Screw

PQRY-P216, 240TLMU-A1

Unit: mm(in)

PQRY-P-T(S)LMU-A1, Y(S)LMU-A1

- <Accessories>
- Refrigerant (high pressure) conn. pipe.....1pc.
(P216/P240 ; Packaged in the accessory kit)
 - Refrigerant (low pressure) conn. pipe.....1pc.
(P216/P240 ; Packaged in the accessory kit)
 - Water stopper.....1pc.
 - Sealing material for water stopper.....1pc.
(P216/P240 ; Packaged in the accessory kit)
 - Sealing material for field piping (high pressure, low pressure).....1pc. each
(P216/P240 ; Packaged in the accessory kit)
 - Sealing material for drain socket.....1pc.
(P216/P240 ; Packaged in the accessory kit)
 - Pipe cover for low pressure.....1pc.
 - (P216/P240 ; Packaged in the accessory kit)
 - Sealing material for base leg (two types).....4pc. each
(P216/P240 ; Packaged in the accessory kit)
 - Sealing material for panel.....1pc.
(P216/P240 ; Packaged in the accessory kit)

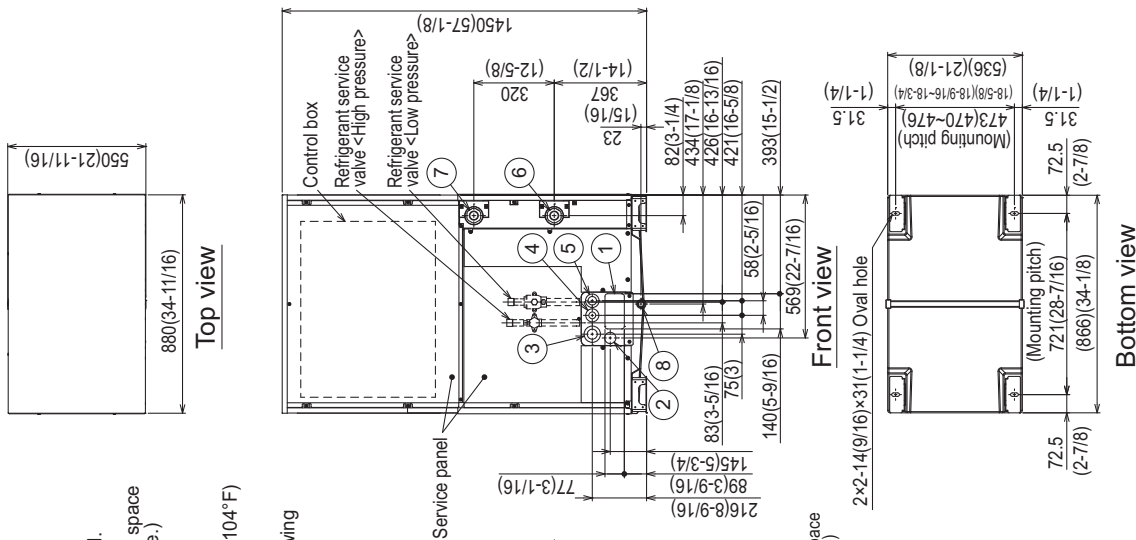
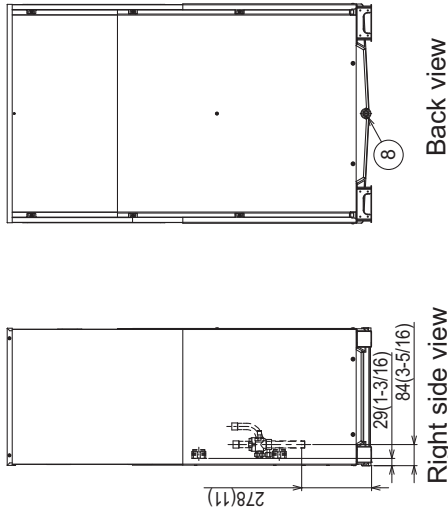

NO.	Usage	Specifications
①	Front through hole	140 x 77 Knockout hole (5-9/16) (3-1/16)
②	For pipes	Front through hole (Uses when twinning kit (optional parts) is mounted.) ø45 Knockout hole (1-13/16)
③	For wires	Front through hole ø62.7 or ø34.5 Knockout hole (2-1/2) (1-3/8)
④	For transmission cables	Front through hole ø43.7 or ø22.2 Knockout hole (1-3/4) (7/8)
⑤	Water pipe inlet	ø34 Knockout hole (1-3/8)
⑥	Water pipe outlet	NPT1-1/2 Screw
⑦	Drain pipe	NPT1-1/2 Screw
⑧		Rc3/4 Screw

- Note1. Close a hole of the water piping, the refrigerant piping, the power supply, and the control wiring and unused knockout holes with the putty etc. so as not to infiltrate rain water etc. (field erection work)
- Note2. At the time of product shipment, the front side piping specification serves as the local drainage connection. When connecting on the rear side, please remove the rear side plug sealing corks, and attach a front side. Ensure there is no leak after the attachment has been fitted.
- Note3. Take notice of service space as Fig.A. (In case of single installation, 600mm(23-5/8) or more of back space as front space makes easier access when servicing the unit from rear side.)
- Note4. If water pipes or refrigerant pipes stretch upward, required space for service and maintenance due to replacement of control box is shown in Fig.B.
- Note5. Environmental condition for installation: -20~40°C(DB) (-4~104°F) as indoor installation.
- Note6. In case the temperature around the heat source unit has possibility to drop under 0°C(32°F), be careful for the following point to prevent the pipe burst by the water pipe freeze-up.
•Circulate the water all the time even if the heat source unit is not in operation.
•Drain the water from inside of the heat source unit when the heat source unit will not operate for a long term.
- Note7. Ensure that the drain piping is downward with a pitch of more than 1/100.
- Note8. At brazing of pipes, wrap the refrigerant service valve with wet cloth and keep the temperature of refrigerant service valve under 120°C(248°F).

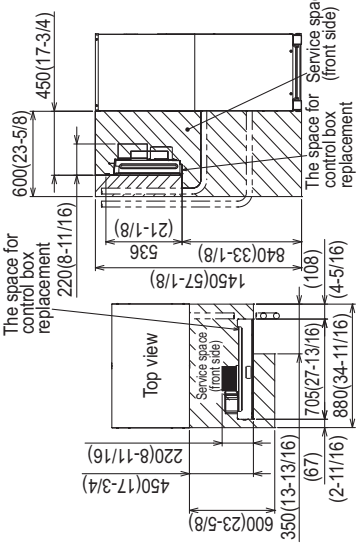

Connecting pipe specifications

Model	Refrigerant pipe	Service valve	Diameter
PQRY-P216TLMU-A1	High pressure Low pressure	High pressure Low pressure	
	ø22.2 Brazed (1-1/8) *1	ø25.4 (1)	ø28.58 (1-1/8)
PQRY-P240TLMU-A1	High pressure Low pressure	High pressure Low pressure	
	ø22.2 Brazed (7/8) *1 *2	ø34.93 Brazed (1-3/8) *1 *3	

- *1. Connect by using the connecting pipes that are supplied.
- *2. When the piping length is 65 m or longer, use the ø28.58(1-1/8) pipe for the part that exceeds 65 m.
- *3. Use the pipe joint(field supply) and connect to the refrigerant service valve piping.

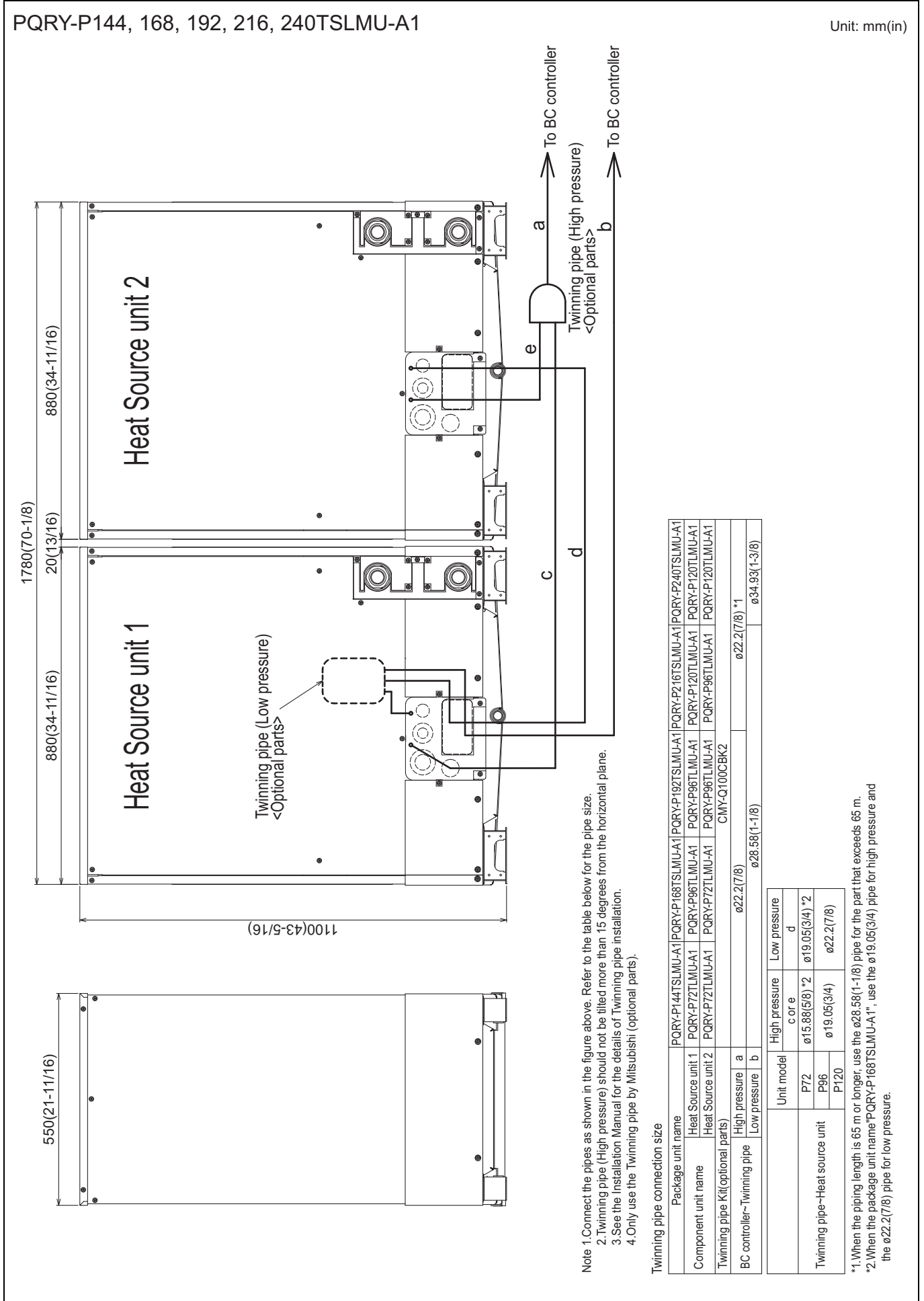

PQRY-P288, 312, 336TSLMU-A1

Unit: mm(in)

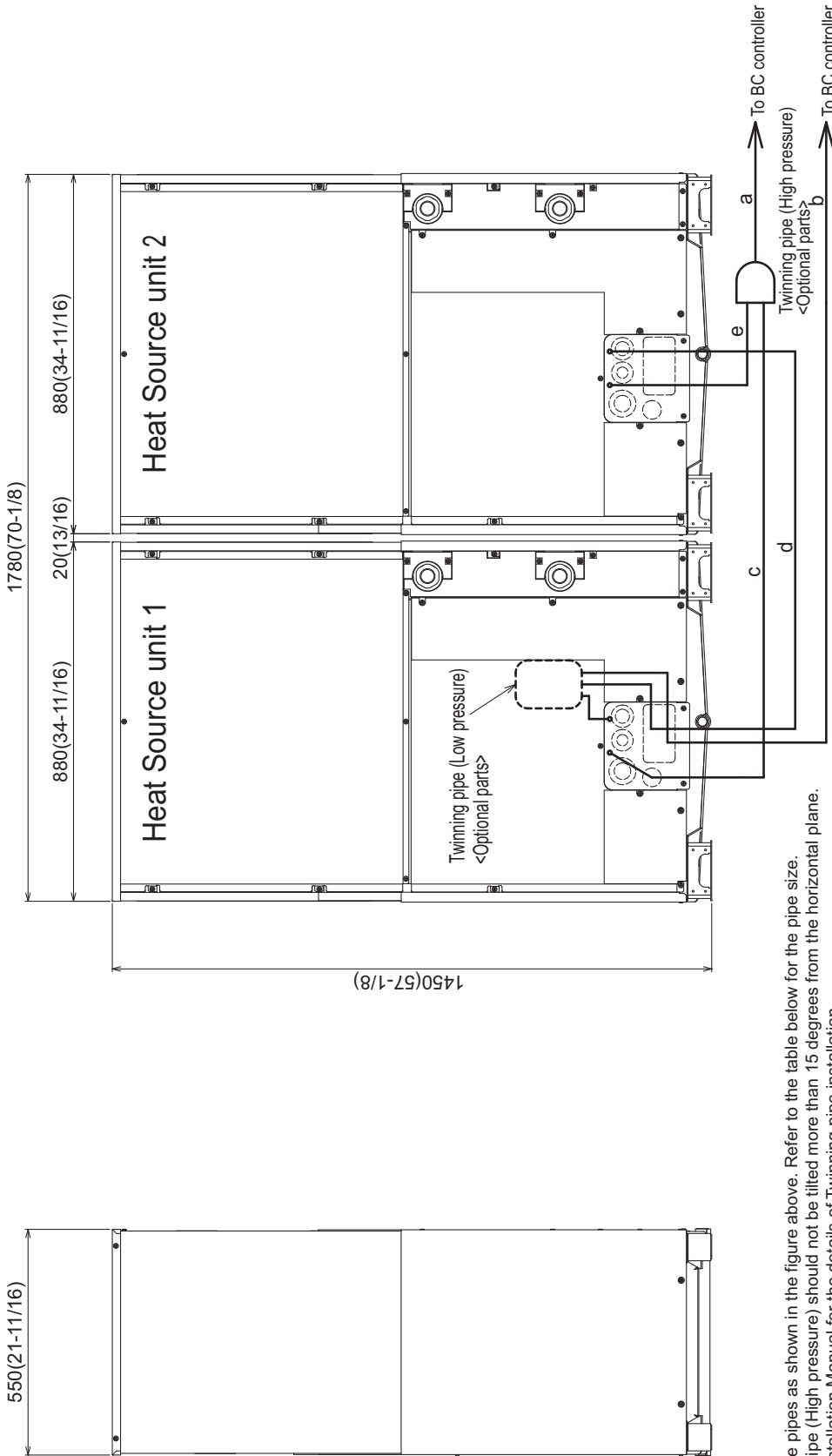

- Note 1. Connect the pipes as shown in the figure above. Refer to the table below for the pipe size.
 2. Twinning pipe (High pressure) should not be tilted more than 15 degrees from the horizontal plane.
 3. See the Installation Manual for the details of Twinning pipe installation.
 4. Only use the Twinning pipe by Mitsubishi (optional parts).

Twinning pipe connection size

Package unit name	PQRY-P288TSLMU-A1 PQRY-P312TSLMU-A1 PQRY-P336TSLMU-A1
Component unit name	Heat Source unit 1 PQRY-P144TLMU-A1 PQRY-P168TLMU-A1 PQRY-P144TLMU-A1 PQRY-P168TLMU-A1
Twinning pipe Kit(optional parts)	CMY-Q200CBK
BC controller~Twinning pipe	High pressure a Low pressure b
	ø28.58(1-1/8) ø34.93(1-3/8) ø41.28(1-5/8)

Twinning pipe~Heat source unit	Unit model	High pressure c	Low pressure d
	P144 P168	ø22.2(7/8)	ø28.58(1-1/8)

PQRY-P72, 96, 120YLMU-A1

Unit: mm(in)

- <Accessories>
- Refrigerant (high pressure) conn. pipe 1pc.
(P72/P96/P120; Packaged in the accessory kit)
 - Refrigerant (low pressure) conn. elbow 1pc.
(P72/P96/P120; Packaged in the accessory kit)
 - Water stopper 1pc.
(P72/P96/P120; Packaged in the accessory kit)
 - Sealing material for water stopper 1pc.
(P72/P96/P120; Packaged in the accessory kit)
 - Sealing material for field piping (high pressure, low pressure) 1pc. each
(P72/P96/P120; Packaged in the accessory kit)
 - Sealing material for drain socket 1pc.
(P72/P96/P120; Packaged in the accessory kit)
 - Pipe cover for low pressure 1pc.
(P72/P96/P120; Packaged in the accessory kit)

- Note1. Close a hole of the water piping, the refrigerant piping, the power supply, and the control wiring and unused knockout holes with the putty etc. so as not to infiltrate rain water etc. (field erection work)
- Note2. At the time of product shipment, the front side piping specification serves as the local drainage connection. When connecting on the rear side, please remove the rear side plug sealing corks, and attach a front side. Ensure there is no leak after the attachment has been fitted.
- Note3. Take notice of service space as Fig.A. (In case of single installation, 600mm(23-5/8) or more of back space as front space makes easier access when servicing the unit from rear side.)
- Note4. If water pipes or refrigerant pipes stretch upward, required space for service and maintenance due to replacement of control box is shown in Fig.B.
- Note5. Environmental condition for installation; -20~40°C(DB) (-4~104°F) as indoor installation.
- Note6. In case the temperature around the heat source unit has possibility to drop under 0°C(32°F), be careful for the following point to prevent the pipe burst by the water pipe freeze-up.
- Circulate the water all the time even if the heat source unit is not in operation.
 - Drain the water from inside of the heat source unit when the heat source unit will not operate for a long term.
- Note7. Ensure that the drain piping is downward with a pitch of more than 1/100.
- Note8. At brazing of pipes, wrap the refrigerant service valve with wet cloth and keep the temperature of refrigerant service valve under 120°C(248°F).

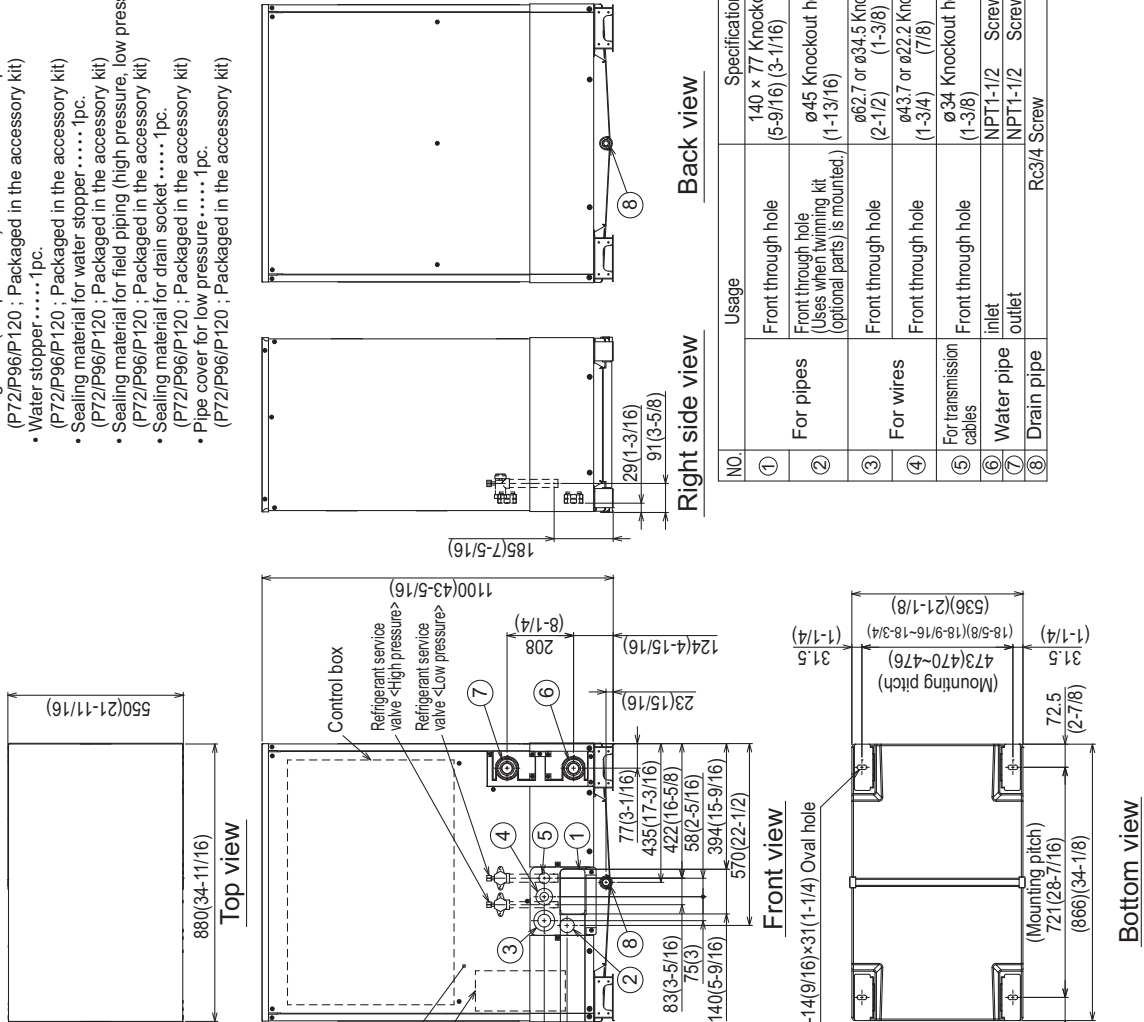

NO.	Usage	Specifications
①	Front through hole	140 x 77 Knockout hole (5-9/16) (3-1/16)
②	For pipes	Front through hole (Uses when twinning kit (optional parts) is mounted.)
③	For wires	Front through hole (2-1/2) (1-13/16)
④	For transmission cables	Front through hole (1-3/4) (7/8)
⑤	Water pipe inlet	Front through hole (1-3/8) (1-13/16)
⑥	Water pipe outlet	Front through hole (1-3/8) (1-13/16)
⑦	Drain pipe	NPT1-1/2 Screw
⑧		Rc3/4 Screw

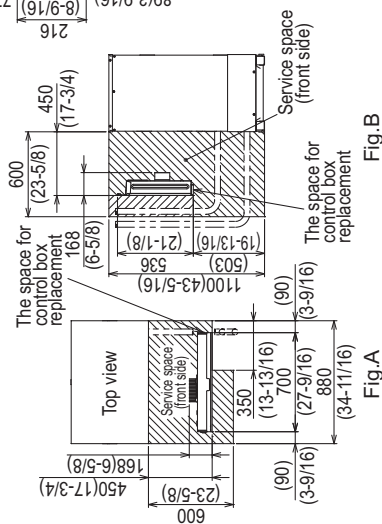

Connecting pipe specifications

Model	Refrigerant pipe		Service valve	
	High pressure	Low pressure	High pressure	Low pressure
PQRY-P72YLMU-A1	ø15.88 Brazed (5/8) *1 *2	ø19.05 Brazed (3/4) *1 *2	ø19.05 (3/4)	ø25.4 (1)
PQRY-P96YLMU-A1	ø19.05 Brazed (3/4) *1	ø22.2 Brazed (7/8) *1 *2		
PQRY-P120YLMU-A1				

*1 Connect by using the connecting pipes and elbow that are supplied.
*2 Use the pipe joint(field supply) and connect to the refrigerant service valve piping.

PQRY-P144, 168, 192YLMU-A1

Unit: mm(in)

PQRY-P-T(S)LMU-A1, Y(S)LMU-A1

- <Accessories>
- Refrigerant (high pressure) conn. pipe.....1pc.
(P144/P168/P192; Packaged in the accessory kit)
 - Refrigerant (low pressure) conn. pipe.....1pc.
(P144/P168/P192; Packaged in the accessory kit)
 - Water stopper.....1pc.
(P144/P168/P192; Packaged in the accessory kit)
 - Sealing material for drain socket.....1pc.
(P144/P168/P192; Packaged in the accessory kit)
 - Sealing material for field piping (high pressure, low pressure).....4pcs. each
(P144/P168/P192; Packaged in the accessory kit)
 - Sealing material for panel.....1pc.
(P144/P168/P192; Packaged in the accessory kit)
 - Pipe cover for low pressure.....1pc.
(P144/P168/P192; Packaged in the accessory kit)
 - Sealing material for base leg (two types).....4pcs. each
(P144/P168/P192; Packaged in the accessory kit)
 - Sealing material for panel.....1pc.
(P144/P168/P192; Packaged in the accessory kit)

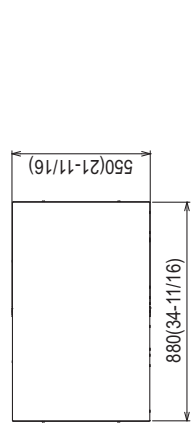

Top view

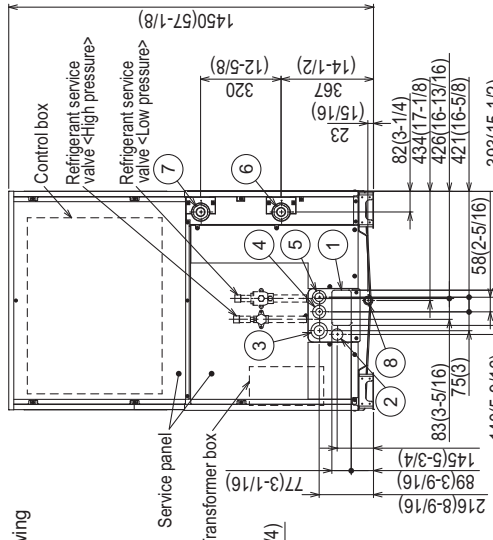

Front view

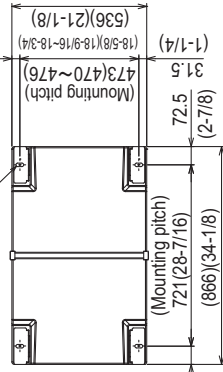

Bottom view

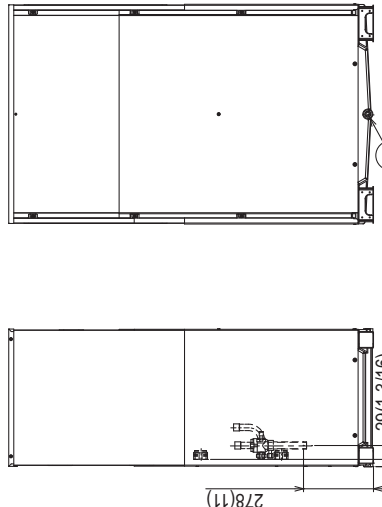

Right side view

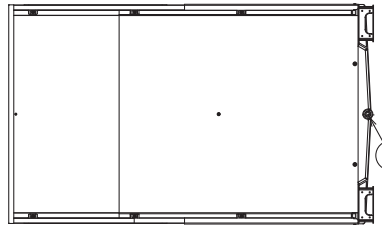

Back view

NO.	Usage	Specifications
①	Front through hole	140 x 77 Knockout hole (5-9/16) (3-1/16)
②	For pipes	Front through hole (Uses when twinning kit (optional parts) is mounted.) (1-13/16)
③	For wires	Front through hole (2-1/2) or ø34.5 Knockout hole (1-3/8)
④	For transmission cables	Front through hole ø43.7 or ø22.2 Knockout hole (1-3/4) (7/8)
⑤	Water pipe inlet	Front through hole ø34 Knockout hole (1-3/8)
⑥	Water pipe outlet	NPT1-1/2 Screw
⑦	Drain pipe	NPT1-1/2 Screw
⑧		RC3/4 Screw

- Note1. Close a hole of the water piping, the refrigerant piping, the power supply, and the control wiring and unused knockout holes with the putty etc. so as not to infiltrate rain water etc. (field erection work)
- Note2. At the time of product shipment, the front side piping specification serves as the local drainage connection. When connecting on the rear side, please remove the rear side plug sealing corks, and attach a front side. Ensure there is no leak after the attachment has been fitted.
- Note3. Take notice of service space as Fig.A. (In case of single installation, 600mm(23-5/8) or more of back space as front space makes easier access when servicing the unit from rear side.)
- Note4. If water pipes or refrigerant pipes stretch upward, required space for service and maintenance due to replacement of control box is shown in Fig.B.
- Note5. Environmental condition for installation; -20~40°C(DB) (-4~104°F) as indoor installation.
- Note6. In case the temperature around the heat source unit has possibility to drop under 0°C(32°F), be careful for the following point to prevent the pipe burst by the water pipe freeze-up.
- Circulate the water, all the time even if the heat source unit is not in operation.
 - Drain the water from inside of the heat source unit when the heat source unit will not operate for a long term.
- Note7. Ensure that the drain piping is downward with a pitch of more than 1/100.
- Note8. At brazing of pipes, wrap the refrigerant service valve with wet cloth and keep the temperature of refrigerant service valve under 120°C(248°F).

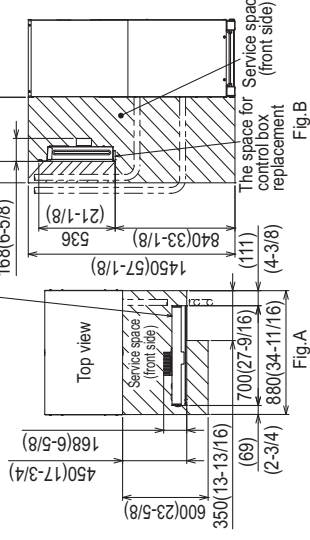

Connecting pipe specifications

Model	Refrigerant pipe		Service valve	
	High pressure	Low pressure	High pressure	Low pressure
PQRY-P144YLMU-A1	ø22.2 Brazed (7/8) *1	ø28.58 (1-1/8) *1	ø25.4 (1)	ø28.58 (1-1/8)
PQRY-P168YLMU-A1				
PQRY-P192YLMU-A1				

*1. Connect by using the connecting pipes that are supplied.

PQRY-P216, 240YLMU-A1

Unit: mm(in)

- <Accessories>
- Refrigerant (high pressure) conn. pipe 1pc.
(P216/P240 ; Packaged in the accessory kit)
 - Refrigerant (low pressure) conn. pipe 1pc.
(P216/P240 ; Packaged in the accessory kit)
 - Water stopper 1pc.
(P216/P240 ; Packaged in the accessory kit)
 - Sealing material for water stopper 1pc.
(P216/P240 ; Packaged in the accessory kit)
 - Sealing material for field piping (high pressure, low pressure) 1pc. each
(P216/P240 ; Packaged in the accessory kit)
 - Sealing material for drain socket 1pc.
(P216/P240 ; Packaged in the accessory kit)
 - Pipe cover for low pressure 1pc.
(P216/P240 ; Packaged in the accessory kit)
 - Sealing material for base leg (two types) 4pcs. each
(P216/P240 ; Packaged in the accessory kit)
 - Sealing material for panel 1pc.
(P216/P240 ; Packaged in the accessory kit)

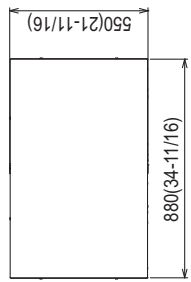

Top view

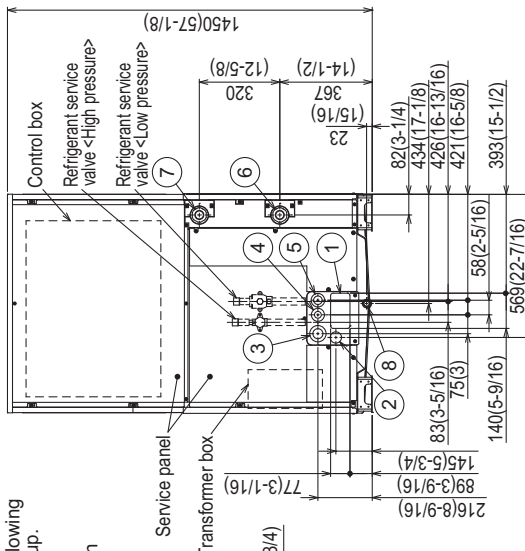

Front view

2x2-14(9/16)x31(1-1/4) Oval hole

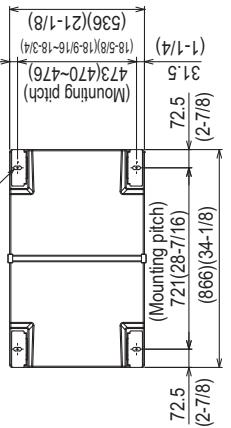

Bottom view

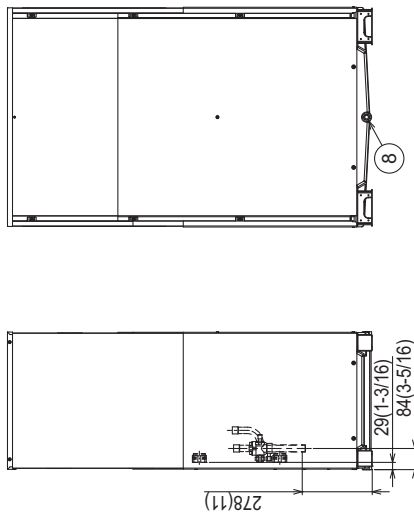

Right side view

Back view

No.	Usage	Specifications
①	Front through hole (Front through hole (Uses when twinning kit (optional parts) is mounted.)	140 x 77 Knockout hole (5-9/16) (3-1/16)
②	For pipes	ø45 Knockout hole (1-13/16)
③	For wires	ø62.7 or ø34.5 Knockout hole (2-1/2) (1-3/8)
④	For transmission cables	ø43.7 or ø22.2 Knockout hole (1-3/4) (7/8)
⑤	Water pipe inlet	ø34 Knockout hole (1-3/8)
⑥	Water pipe outlet	NPT 1-1/2 Screw
⑦	Drain pipe	NPT 1-1/2 Screw
⑧		Rc3/4 Screw

- Note1. Close a hole of the water piping, the refrigerant piping, the power supply, and the control wiring and unused knockout holes with the putty etc. so as not to infiltrate rain water etc.(field erection work).
- Note2. At the time of product shipment, the front side piping specification serves as the local drainage connection. When connecting on the rear side, please remove the rear side plug, sealing corks, and attach a front side. Ensure there is no leak after the attachment has been fitted.
- Note3. Take notice of service space as Fig.A. (In case of single installation, 600mm(23-5/8) or more of back space as front space makes easier access when servicing the unit from rear side.)
- Note4. If water pipes or refrigerant pipes stretch upward, required space for service and maintenance due to replacement of control box is shown in Fig.B.
- Note5. Environmental condition for installation; -20~40°C(DB) (-4~104°F) as indoor installation.
- Note6. In case the temperature around the heat source unit has possibility to drop under 0°C(32°F), be careful for the following point to prevent the pipe burst by the water pipe freeze-up.
•Circulate the water all the time even if the heat source unit is not in operation.
•Drain the water from inside of the heat source unit when the heat source unit will not operate for a long term.
- Note7. Ensure that the drain piping is downward with a pitch of more than 1/100.
- Note8. At brazing of pipes, wrap the refrigerant service valve with wet cloth and keep the temperature of refrigerant service valve under 120°C(248°F).

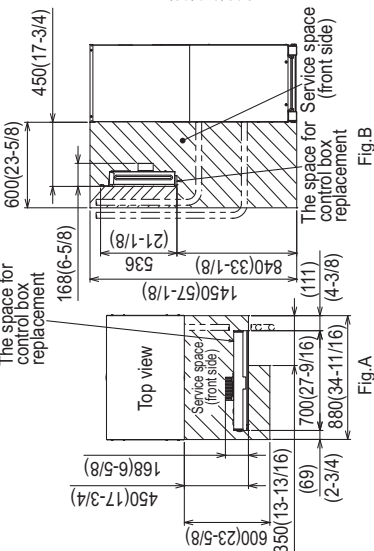

Fig.A

Fig.B

Connecting pipe specifications

Model	Refrigerant pipe		Service valve	
	High pressure	Low pressure	High pressure	Low pressure
PQRY-P216YLMU-A1	ø22.2 Brazed (1-1/8) *1	ø28.58 Brazed (1-1/8) *1	ø25.4 (1)	ø28.58 (1-1/8)
PQRY-P240YLMU-A1	ø25.4 Brazed (1-3/8) *2	ø34.93 Brazed (1-3/8) *3		

- *1. Connect by using the connecting pipes and that are supplied.
*2. When the piping length is 65 m or longer, use the ø28.58(1-1/8) pipe for the part that exceeds 65 m.
*3. Use the pipe joint(field supply) and connect to the refrigerant service valve piping.

PQRY-P144, 168, 192, 216, 240YSLMU-A1

Unit: mm(in)

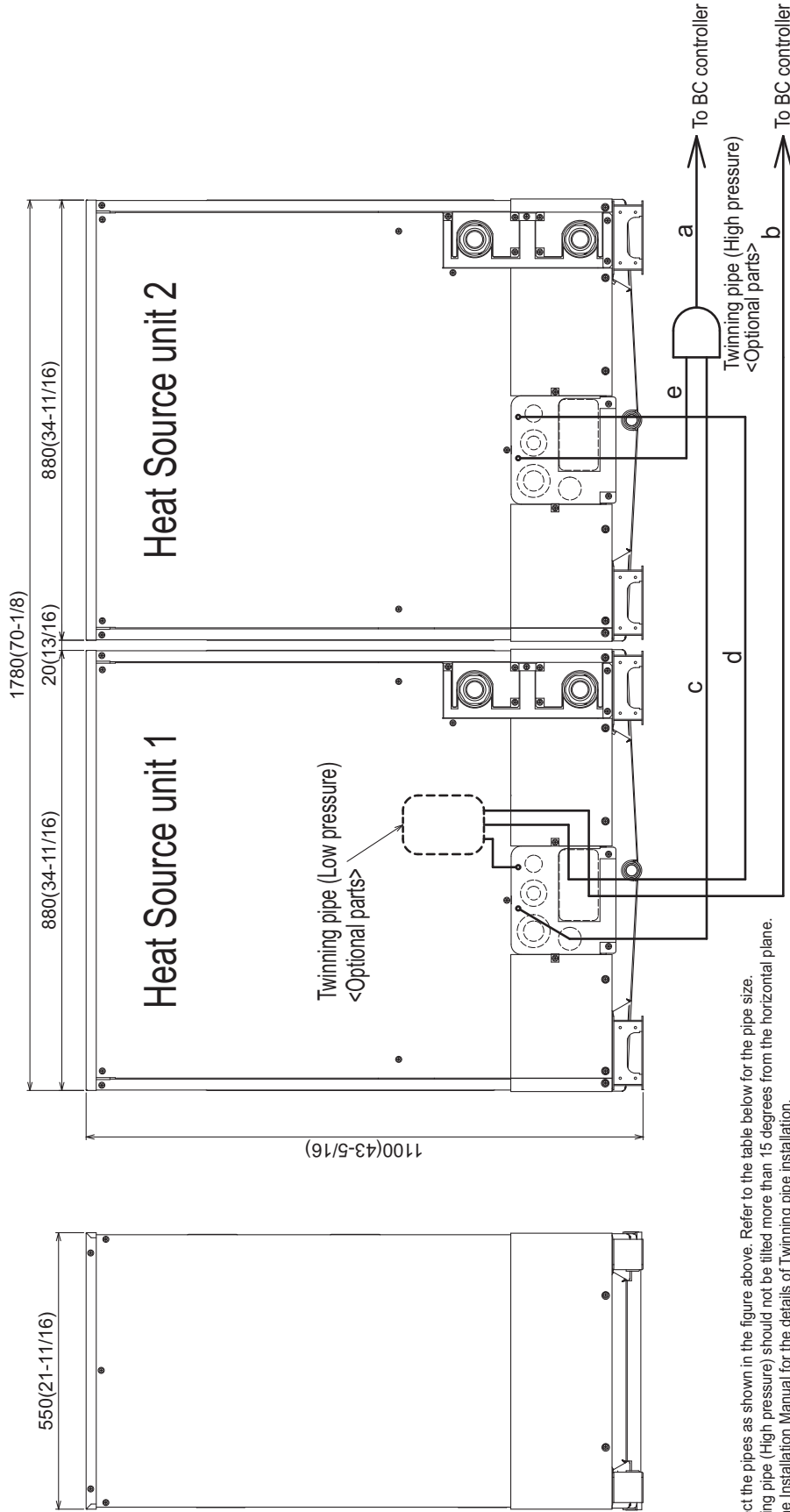

- Note 1. Connect the pipes as shown in the figure above. Refer to the table below for the pipe size.
- 2. Twinning pipe (High pressure) should not be filled more than 15 degrees from the horizontal plane.
- 3. See the Installation Manual for the details of Twinning pipe installation.
- 4. Only use the Twinning pipe by Mitsubishi (optional parts).

Twinning pipe connection size

Package unit name	PQRY-P144YSLMU-A1 PQRY-P168YSLMU-A1 PQRY-P192YSLMU-A1 PQRY-P216YSLMU-A1 PQRY-P240YSLMU-A1
Component unit name	Heat Source unit 1 PQRY-P72YLMU-A1 PQRY-P96YLMU-A1 PQRY-P120YLMU-A1 PQRY-P144YLMU-A1 PQRY-P168YLMU-A1 PQRY-P192YLMU-A1 PQRY-P216YLMU-A1 PQRY-P240YLMU-A1
Twinning pipe (if optional parts)	PQRY-P72YLMU-A1 PQRY-P96YLMU-A1 PQRY-P120YLMU-A1 PQRY-P144YLMU-A1 PQRY-P168YLMU-A1 PQRY-P192YLMU-A1 PQRY-P216YLMU-A1 PQRY-P240YLMU-A1
BC controller ~ Twinning pipe	High pressure Low pressure
	a b
	ø22.2(7/8) ø28.58(1-1/8)
	ø22.2(7/8) *1 ø34.93(1-3/8)

Twinning pipe ~ Heat source unit	Unit model	High pressure Low pressure
	c or e	d
Twinning pipe ~ Heat source unit	P72	ø15.88(5/8) *2 ø19.05(3/4) *2
	P96	ø19.05(3/4) ø22.2(7/8)
	P120	ø22.2(7/8)

*1. When the piping length is 65 m or longer, use the ø28.58(1-1/8) pipe for the part that exceeds 65 m.
 *2. When the package unit name "PQRY-P168YSLMU-A1", use the ø19.05(3/4) pipe for high pressure and the ø22.2(7/8) pipe for low pressure.

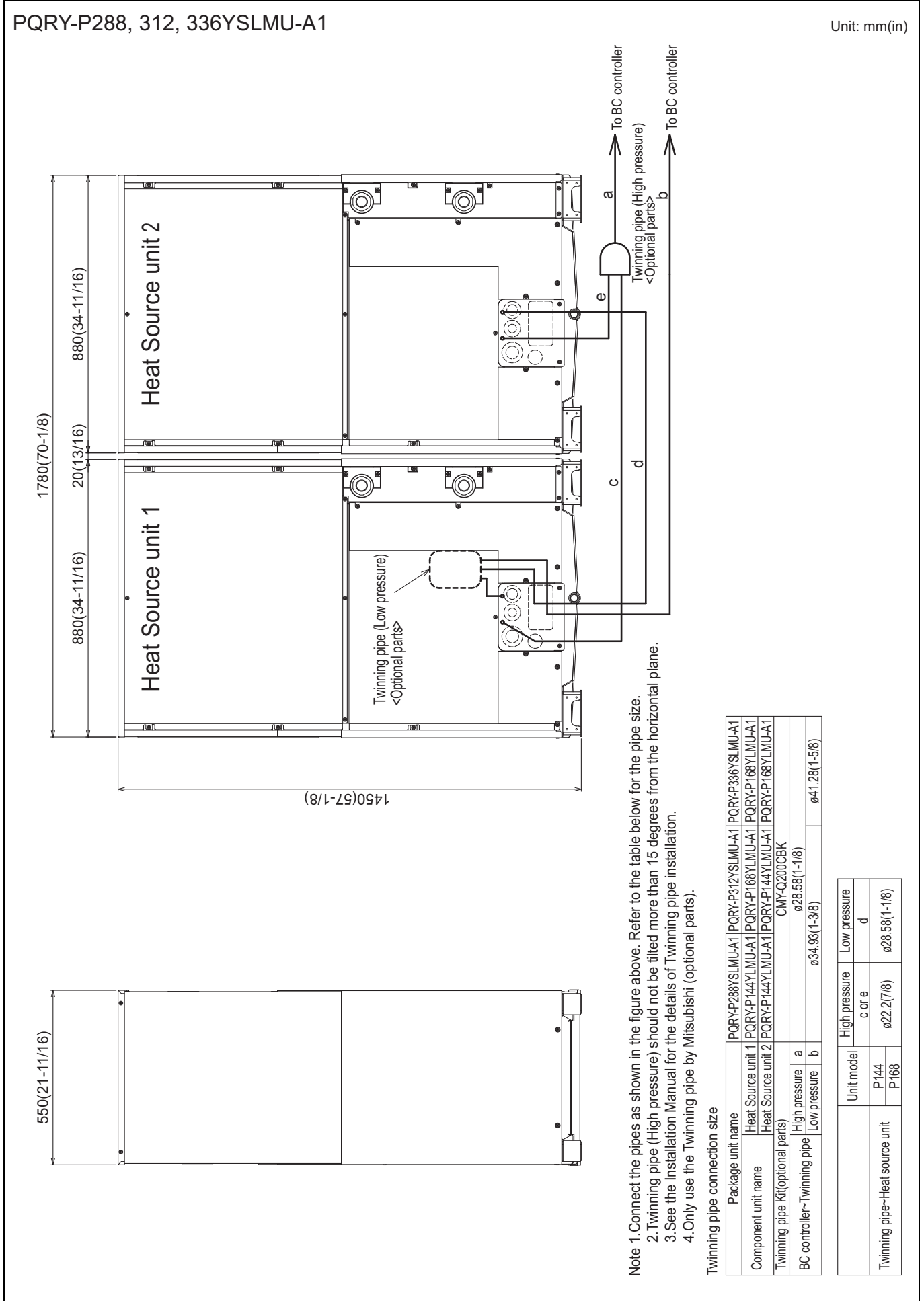

PQRY-P-T(S)LMU-A1, Y(S)LMU-A1

PQRY-P72, 96, 120TLMU-A1/YLMU-A1

Unit: mm [in.]

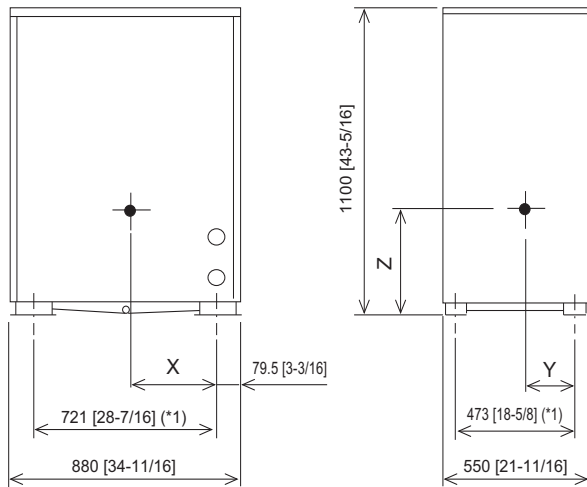

Model	X	Y	Z
PQRY-P72TLMU-A1	351 [13-7/8]	235 [9-5/16]	438 [17-1/4]
PQRY-P96TLMU-A1	351 [13-7/8]	235 [9-5/16]	438 [17-1/4]
PQRY-P120TLMU-A1	351 [13-7/8]	235 [9-5/16]	438 [17-1/4]
PQRY-P72YLMU-A1	370 [14-5/8]	224 [8-7/8]	428 [16-7/8]
PQRY-P96YLMU-A1	370 [14-5/8]	224 [8-7/8]	428 [16-7/8]
PQRY-P120YLMU-A1	370 [14-5/8]	224 [8-7/8]	428 [16-7/8]

*1 Mounting Pitch

PQRY-P144, 168, 192, 216, 240TLMU-A1/YLMU-A1

Unit: mm [in.]

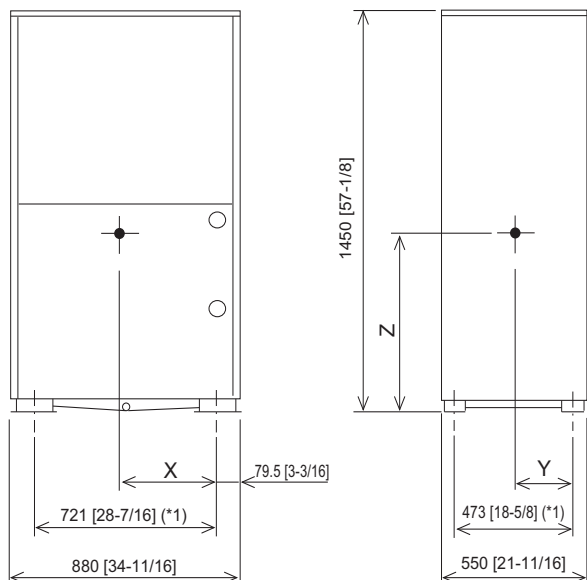

Model	X	Y	Z
PQRY-P144TLMU-A1	382 [15-1/16]	233 [9-3/16]	622 [24-1/2]
PQRY-P168TLMU-A1	382 [15-1/16]	233 [9-3/16]	622 [24-1/2]
PQRY-P192TLMU-A1	382 [15-1/16]	233 [9-3/16]	622 [24-1/2]
PQRY-P216TLMU-A1	371 [14-5/8]	232 [9-3/16]	685 [27]
PQRY-P240TLMU-A1	371 [14-5/8]	232 [9-3/16]	685 [27]
PQRY-P144YLMU-A1	399 [15-3/4]	228 [9]	611 [24-1/16]
PQRY-P168YLMU-A1	399 [15-3/4]	228 [9]	611 [24-1/16]
PQRY-P192YLMU-A1	399 [15-3/4]	228 [9]	611 [24-1/16]
PQRY-P216YLMU-A1	380 [15]	221 [8-3/4]	632 [24-15/16]
PQRY-P240YLMU-A1	380 [15]	221 [8-3/4]	632 [24-15/16]

*1 Mounting Pitch

PQRY-P72, 96, 120TLMU-A1

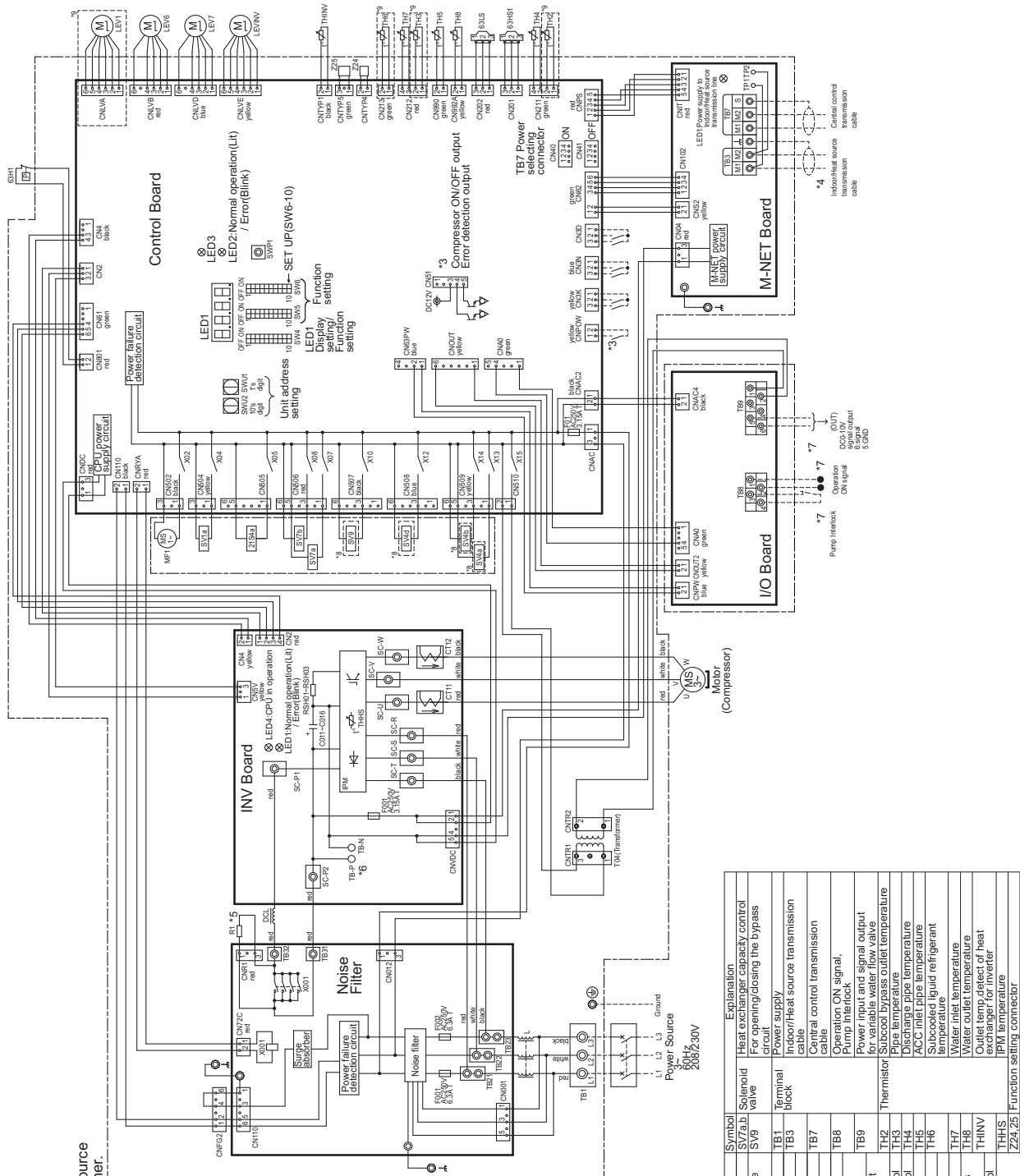

- *1. Single-dotted lines indicate wiring not supplied with the unit.
- *2. Dot-dash lines indicate the control box boundaries.
- *3. Refer to the Data book for connecting input/output signal connectors.
- *4. Daisy-chain terminals (TB3) on the heat source units in the same refrigerant system together.
- *5. Faston terminals have a locking function. Make sure the terminals are securely locked in place after insertion. Press the tab on the terminals to remove them.
- *6. Control box houses high-voltage parts. Before inspecting the inside of the control box, turn off the power, keep the unit off for at least 10 minutes, and confirm that the voltage between TB-P and TB-N on INV Board has dropped to DC20V or less.
- *7. Refer to the Data book for wiring terminal block for Pump Interlock, Operation ON signal and DC0-10V signal output.
- *8. Difference of appliance.
- *9. Difference of appliance.

Model name	Appliance
PQHY	*8 do not exist
PQRY	*8 exist
Model name	Appliance
PQHY	*9 exist
PQRY	*9 do not exist

<Symbol explanation>

Symbol	Explanation
Z1S4a	4-way valve
63H1	Cooling/Heating switching switch
63HS1	Pressure high pressure protection for the heat source unit
X00T	Pressure sensor
CNT1-C016	Magnetic relay (inverter main circuit)
CNT1-T12	Capacitor (inverter main circuit)
DOL	Current sensor (AC)
L	Choke coil (for high frequency noise reduction)
LEV1	Linear expansion valve
LEV6	HIC bypass. Controls refrigerant flow in HIC circuit
LEV7	Heat exchanger capacity control valve
LEVNV	Heat exchanger capacity control valve for inverter
MF1	Fan motor (radiator panel)
RSW-4S02	Resistor
SV1a	For inrush current prevention
SV1a,b,d	For current limiting
SV1a,b,d	For opening/closing the bypass circuit under the OS
THHS	Heat exchanger capacity control
Z24,25	Function setting connector

PQRY-P144, 168, 192TLMU-A1

PQRY-P-T(S)LMU-A1, Y(S)LMU-A1

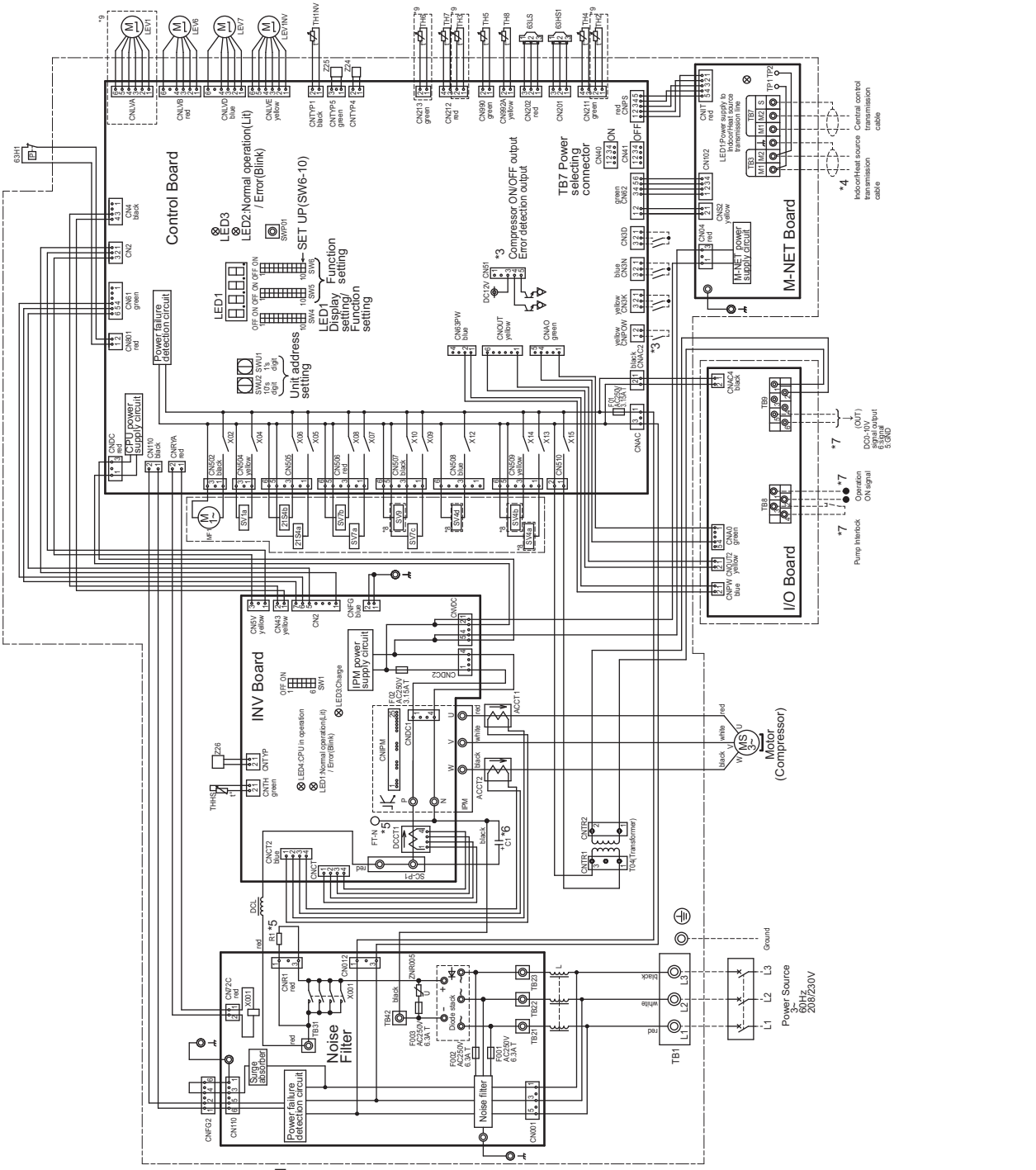

- *1. Single-dotted lines indicate wiring not supplied with the unit.
- *2. Dot-dash lines indicate the control box boundaries.
- *3. Refer to the Data book for connecting input/output signal connectors.
- *4. Daisy-chain terminals (TB3) on the heat source units in the same refrigerant system together.
- *5. Faston terminals have a locking function. Make sure the terminals are securely locked in place after insertion. Press the tab on the terminals to removed them.
- *6. Control box houses high-voltage parts. Before inspecting the inside of the control box, turn off the power, keep the unit off for at least 10 minutes, and confirm that the voltage at both ends of the main capacitor (C1) has dropped to DC20V or less.
- *7. Refer to the Databook for wiring terminal block for Pump interlock, Operation ON signal and DC0-10V signal output.
- *8. Difference of appliance.

Model name	Appliance
PQHY	*8 do not exist
PQRY	*8 exist
- *9. Difference of appliance.

Model name	Appliance
PQHY	*9 exist
PQRY	*9 do not exist

<Symbol explanation>

Symbol	Explanation
ZTS4a	4-way valve (Cooling/Heating switching)
ZTS4b	Heat exchanger capacity control
63H1	High pressure protection for the pressure sensor
63L1	High pressure sensor
63LS	Low pressure sensor
X01	Magnetic relay (inverter main circuit)
C1	Capacitor (inverter main circuit)
ACCT1.2	Current sensor (AC)
DCCT1	Current sensor (DC)
DCL	DC reactor
L	Choke coil (for high frequency noise reduction)
LEV1	4FC bypass/Controls refrigerant pressure
LEV6	Heat exchanger capacity control valve
LEV7	Heat exchanger capacity control valve
LEVINV	Heat exchanger for inverter
MF1	Fan motor (Radiator panel)
R1	Resistor
SV1a	For opening/closing the bypass circuit under the OIS
SV4a,b,d	Heat exchanger capacity control valve
SV7a,b,c	Heat exchanger capacity control valve
SV9	For opening/closing the bypass circuit
TB1	Power supply
TB3	Indoor/Heat source transmission cable
TB7	Central control transmission cable
TB8	Operation ON signal, Pump interlock
TB9	Power input and signal output for fan motor
TH2	Thermistor
TH3	Subcooled bypass outlet temperature
TH4	Pipe temperature
TH5	Discharge pipe temperature
TH6	ACC inlet pipe temperature
TH7	Subcooled liquid refrigerant temperature
TH8	Water inlet temperature
TH9	Water outlet temperature
THINV	Outlet temp. detect of heat exchanger for inverter
THHS	IPM temperature
Z24,25,26	Function setting connector

PQRY-P216, 240TLMU-A1

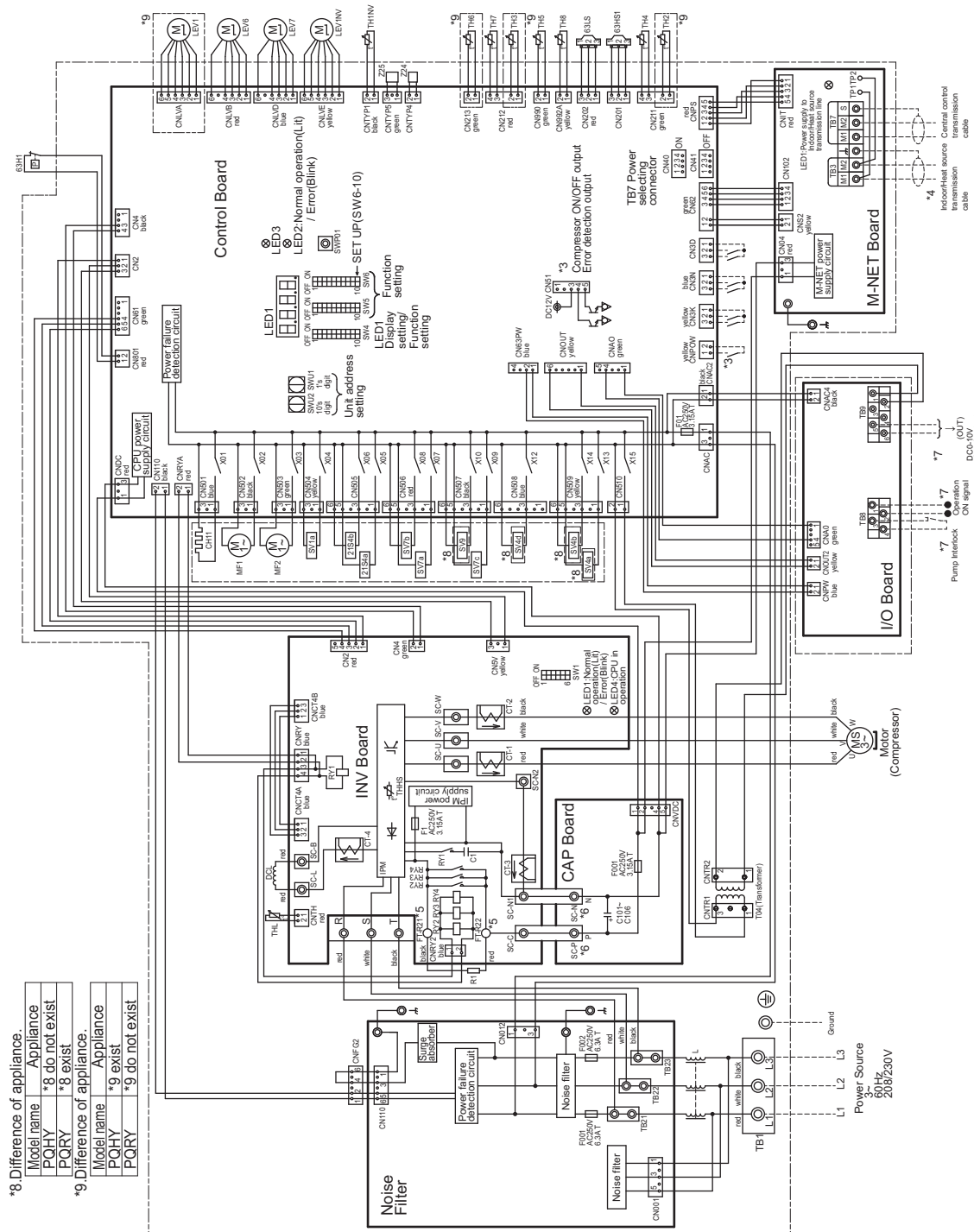

*8. Difference of appliance.

Model name	Appliance
POHY	*8 do not exist
PQRY	*8 exist

*9. Difference of appliance.

Model name	Appliance
POHY	*9 exist
PQRY	*9 do not exist

- *1. Single-dotted lines indicate wiring not supplied with the unit.
- *2. Dot-dash lines indicate the control box boundaries.
- *3. Refer to the Data book for connecting input/output signal connectors.
- *4. Daisy-chain terminals (TB3) on the heat source units in the same refrigerant system together.
- *5. Faston terminals have a locking function. Make sure the terminals are securely locked in place after insertion. Press the tab on the terminals to removed them.
- *6. Control box houses high-voltage parts. Before inspecting the inside of the control box, turn off the power, keep the unit off for at least 10 minutes, and confirm that the voltage between SC-P and SC-N on CAP Board has dropped to DC20V or less.
- *7. Refer to the Data book for wiring terminal block for Pump Interlock, Operation ON signal and DCU-10V signal output.

<Symbol explanation>

Symbol	Explanation
21SAa	4-way valve
21SAb	Cooling/Heating switching
63HT	Heat exchanger capacity control
63HS1	Pressure switch
63HS2	High pressure protection for the heat source unit
63LS	High pressure sensor
CI	Low pressure capacitor filter circuit
CI01-CI06	Inverter main circuit
CH1	Crankcase heater (for heating the compressor)
CH1-CI2	Current sensor (CC)
CI-3, CI-4	DC reactor
DGL	Choke coil (for high frequency noise reduction)
LEV1	Linear HC bypass Controls refrigerant expansion flow in HIC circuit
LEV6	Heat exchanger capacity control valve
LEV7	Heat exchanger capacity control valve
LEV8	Heat exchanger for inverter
RFV-IMP2	Fan inverter (radistor panel)
RY1	Relay (current prevention)
RY2,RY3,RY4	Magnetic relay
SV1a	Inverter main circuit (ZCC)
SV4a,b,d	For opening/closing the bypass circuit under the O/S
SV7a,b,c	Heat exchanger capacity control valve
SV9	For opening/closing the bypass circuit
TB1	Power supply terminal block
TB3	Power/heat source transmission cable
TB7	Central control transmission cable
TB8	Operation ON signal, Pump Interlock
TB9	Power input and signal output for variable water flow valve
TH2	Subcool bypass outlet temperature
TH3	Pipe temperature
TH4	Water inlet temperature
TH5	ACC inlet pipe temperature
TH6	Subcooled liquid refrigerant temperature
TH7	Water inlet temperature
TH8	Water outlet temperature
TH8V	Water inlet temperature
TH8V	Water outlet temperature
TH8V	Outlet temp. detect of heat exchanger for inverter
THHS	IPM temperature
THL	DCL temperature
ZZ4,Z5	Function setting connector

PQRY-P-T(S)LMU-A1, Y(S)LMU-A1

PQRY-P72, 96, 120, 144, 168, 192, 216, 240YLMU-A1

PQRY-P-T(S)LMU-A1, Y(S)LMU-A1

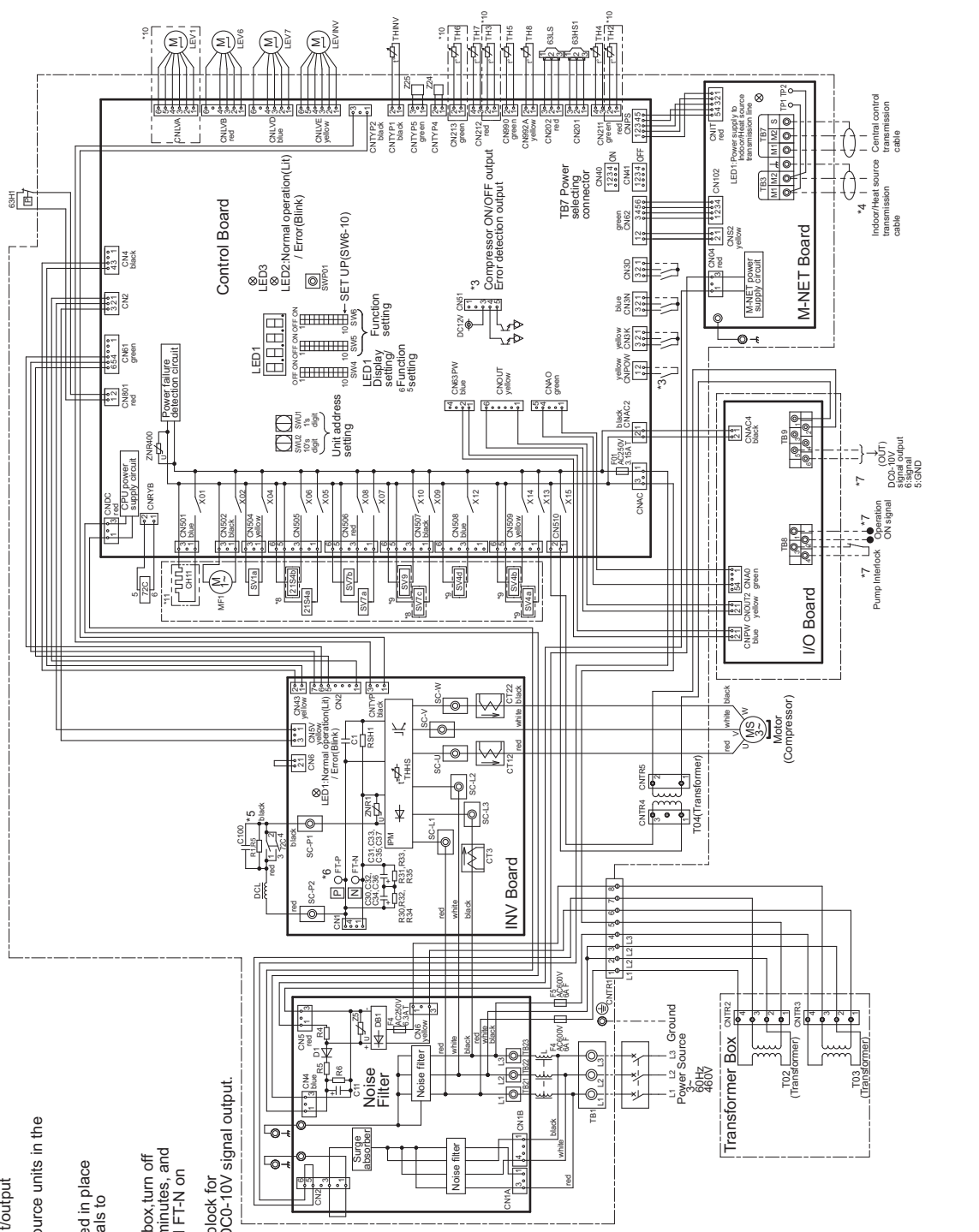

- *1 Single-dotted lines indicate wiring not supplied with the unit.
- *2 Dotted lines indicate the control box boundaries.
- *3 Refer to the Data book for connecting input/output signal connectors.
- *4 Daisy-chain terminals (TB3) on the heat source units in the same refrigerant system together.
- *5 Fasten terminals have a locking function. Make sure the terminals are securely locked in place after insertion. Press the tab on the terminals to removed them.
- *6 Control box houses high-voltage parts. Before inspecting the inside of the control box, turn off the power, keep the unit off for at least 10 minutes, and confirm that the voltage between FT-P and FT-N on INV Board has dropped to DC20V or less.
- *7 Refer to the Data book for wiring terminal block for Pump Interlock, Operation ON signal and DCU-10V signal output.
- *8 Difference of appliance.
- *9 Difference of appliance.
- *10 Difference of appliance.

Model name	Appliance
P72/96/120	*8 do not exist
P144/168/192/216/240	*8 exist
Model name	Appliance
PQRY	*9 do not exist
PQRY	*9 exist
Model name	Appliance
PQRY	*10 exist
PQRY	*10 do not exist

<Symbol explanation>

Symbol	Explanation
Z154A	4-way valve
Z154B	Cooling/Heating switching
63H1	Heat exchanger capacity control
63H2	High pressure protection for the pressure
63H3	Pressure
63H4	High pressure
63H5	Pressure sensor
63H6	Low pressure
ZC	Magnetic relay (inverter main circuit)
C30-C37	Capacitor (inverter main circuit)
GH11	Crankcase heater (for heating the compressor)
CT12,22.3	Current sensor (for the compressor)
DCL	DC reactor
L	Choke coil (for high frequency noise reduction)
LEV1	Linear expansion valve
LEV2	Linear expansion valve
LEV3	Linear expansion valve
LEV4	Linear expansion valve
LEV5	Linear expansion valve
LEV6	Linear expansion valve
LEV7	Linear expansion valve
LEV8	Linear expansion valve
LEV9	Linear expansion valve
LEV10	Linear expansion valve
LEV11	Linear expansion valve
LEV12	Linear expansion valve
LEV13	Linear expansion valve
LEV14	Linear expansion valve
LEV15	Linear expansion valve
RF1	Fan motor (Radiator panel)
RS1a	Resistor
SV1a	Solenoid valve
SV1a.b.d	Solenoid valve
SV1a.b.c	Solenoid valve
SV9	Solenoid valve
TB1	Terminal block
TB3	Terminal block
TB7	Terminal block
TB8	Terminal block
TB9	Terminal block
TH2	Thermistor
TH3	Thermistor
TH4	Thermistor
TH5	Thermistor
TH6	Thermistor
TH7	Thermistor
TH8	Thermistor
TH9	Thermistor
TH10	Thermistor
TH11	Thermistor
TH12	Thermistor
TH13	Thermistor
TH14	Thermistor
TH15	Thermistor
TH16	Thermistor
TH17	Thermistor
TH18	Thermistor
TH19	Thermistor
TH20	Thermistor
TH21	Thermistor
TH22	Thermistor
TH23	Thermistor
TH24	Thermistor
TH25	Thermistor

*11 Difference of appliance.
 Model name Appliance
 P72/96/120/144/168/192 *11 do not exist
 P216/240 *11 exist

Measurement condition
PQRY-P72, 96, 120TLMU-A1/YLMU-A1

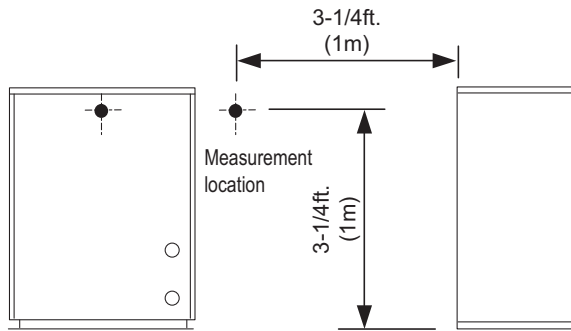

Sound level of PQRY-P120TLMU-A1/YLMU-A1

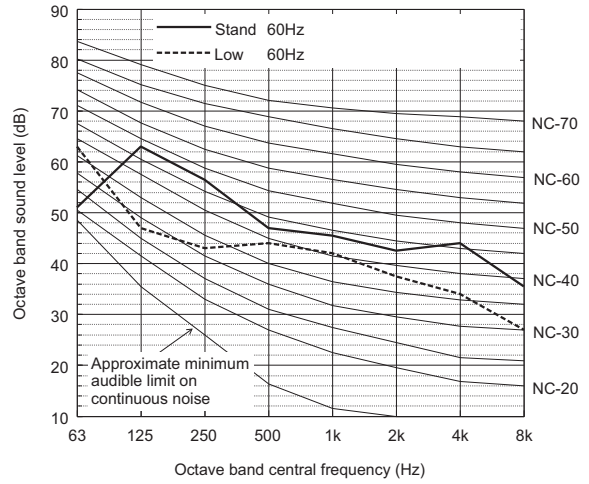

		63	125	250	500	1k	2k	4k	8k	dB(A)
Standard	60Hz	51.0	63.0	56.5	47.0	45.5	42.5	44.0	35.5	54.0
Low noise mode	60Hz	63.0	47.0	43.0	44.0	42.0	37.5	34.0	27.0	47.0

When Low noise mode is set, the A/C system's capacity is limited. The system could return to normal operation from Low noise mode automatically in the case that the operation condition is severe.

Sound level of PQRY-P72TLMU-A1/YLMU-A1

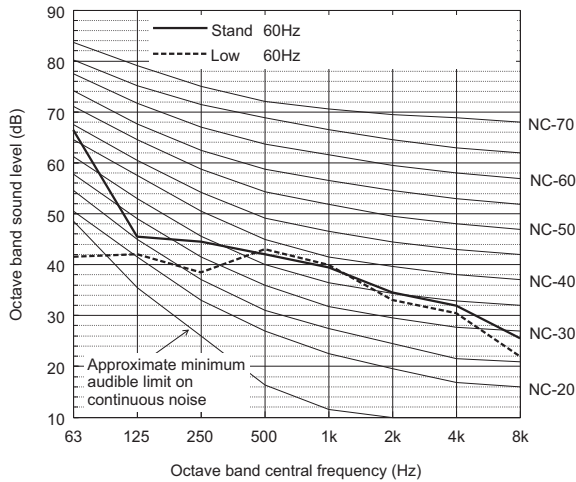

		63	125	250	500	1k	2k	4k	8k	dB(A)
Standard	60Hz	66.5	45.5	44.5	42.0	39.5	34.5	32.0	25.5	46.0
Low noise mode	60Hz	41.5	42.0	38.5	43.0	40.0	33.0	30.5	22.0	44.0

When Low noise mode is set, the A/C system's capacity is limited. The system could return to normal operation from Low noise mode automatically in the case that the operation condition is severe.

Sound level of PQRY-P96TLMU-A1/YLMU-A1

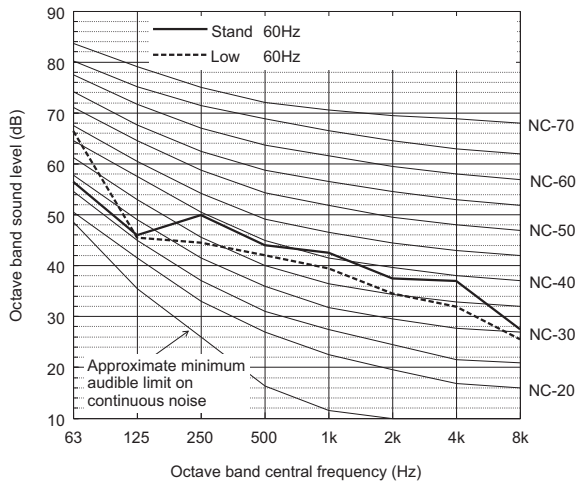

		63	125	250	500	1k	2k	4k	8k	dB(A)
Standard	60Hz	56.5	46.0	50.0	44.0	42.5	37.5	37.0	27.5	48.0
Low noise mode	60Hz	66.5	45.5	44.5	42.0	39.5	34.5	32.0	25.5	46.0

When Low noise mode is set, the A/C system's capacity is limited. The system could return to normal operation from Low noise mode automatically in the case that the operation condition is severe.

- Depending on the operation conditions, the unit generates noise caused by valve actuation, refrigerant flow, and pressure changes when operating normally. Please consider to avoid location where quietness is required. For BC controller, it is recommended to be installed in places such as ceilings of corridor, rest rooms and plant rooms.

Measurement condition
PQRY-P144, 168, 192, 216, 240TLMU-A1/YLMU-A1

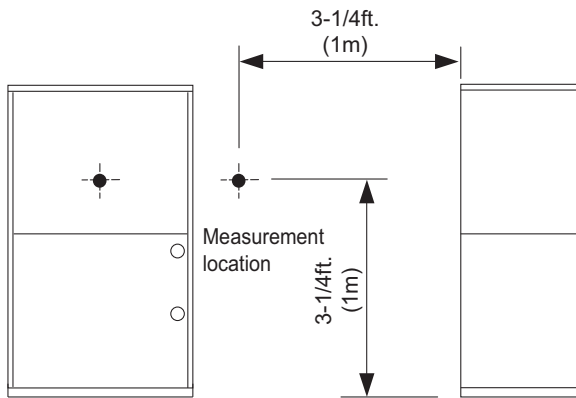

Sound level of PQRY-P192TLMU-A1/YLMU-A1

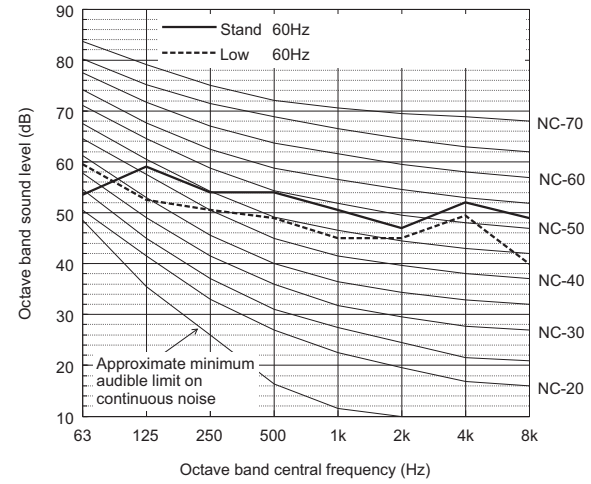

When Low noise mode is set, the A/C system's capacity is limited. The system could return to normal operation from Low noise mode automatically in the case that the operation condition is severe.

Sound level of PQRY-P144TLMU-A1/YLMU-A1

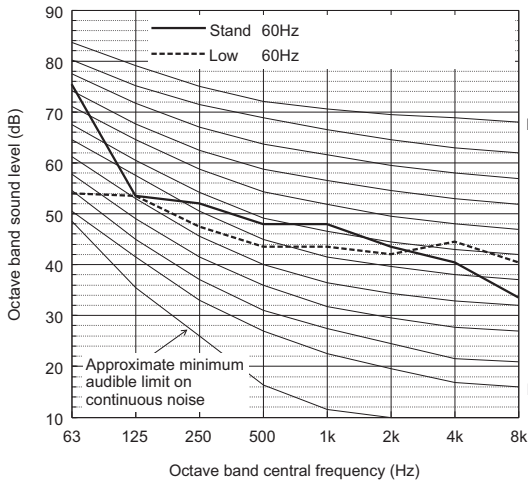

When Low noise mode is set, the A/C system's capacity is limited. The system could return to normal operation from Low noise mode automatically in the case that the operation condition is severe.

Sound level of PQRY-P216TLMU-A1/YLMU-A1

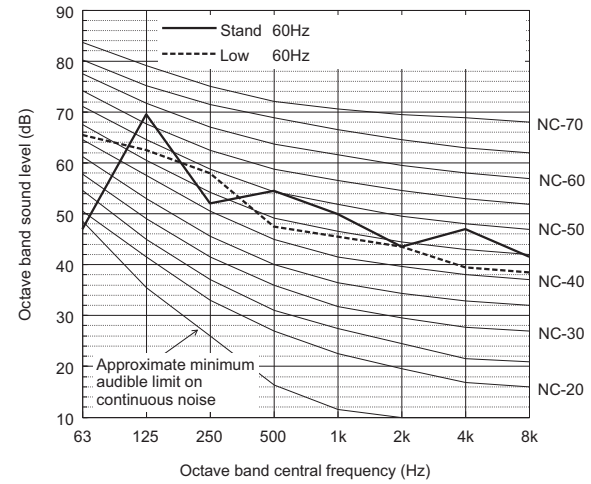

When Low noise mode is set, the A/C system's capacity is limited. The system could return to normal operation from Low noise mode automatically in the case that the operation condition is severe.

Sound level of PQRY-P168TLMU-A1/YLMU-A1

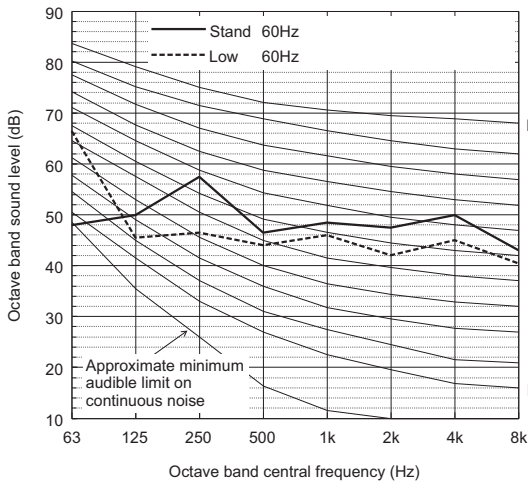

When Low noise mode is set, the A/C system's capacity is limited. The system could return to normal operation from Low noise mode automatically in the case that the operation condition is severe.

Sound level of PQRY-P240TLMU-A1/YLMU-A1

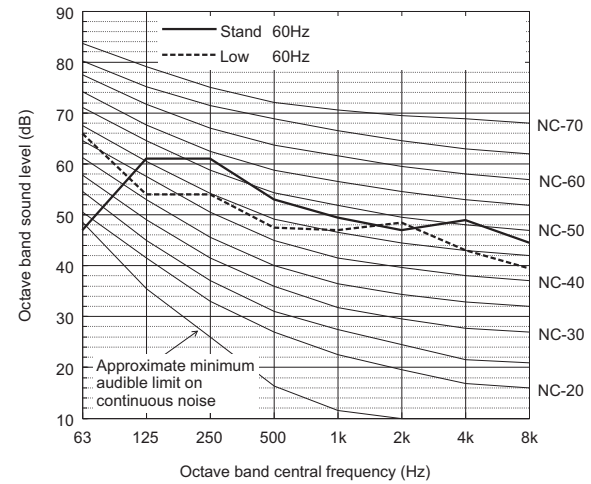

When Low noise mode is set, the A/C system's capacity is limited. The system could return to normal operation from Low noise mode automatically in the case that the operation condition is severe.

♦ Depending on the operation conditions, the unit generates noise caused by valve actuation, refrigerant flow, and pressure changes when operating normally. Please consider to avoid location where quietness is required. For BC controller, it is recommended to be installed in places such as ceilings of corridor, rest rooms and plant rooms.

Measurement condition
PQRY-P144, 168, 192, 216, 240TSLMU-A1/YSLMU-A1

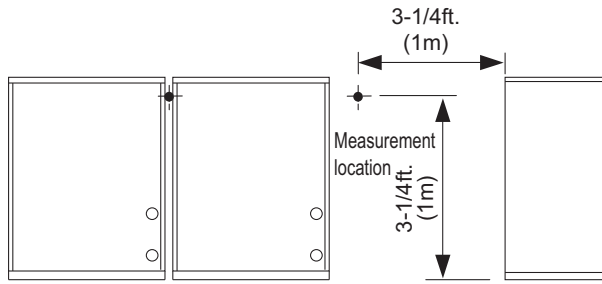

Sound level of PQRY-P192TSLMU-A1/YSLMU-A1

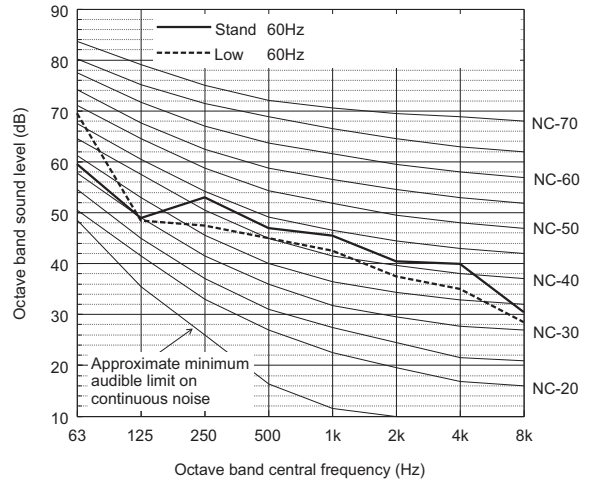

		63	125	250	500	1k	2k	4k	8k	dB(A)
Standard	60Hz	59.5	49.0	53.0	47.0	45.5	40.5	40.0	30.5	51.0
Low noise mode	60Hz	69.5	48.5	47.5	45.0	42.5	37.5	35.0	28.5	49.0

When Low noise mode is set, the A/C system's capacity is limited. The system could return to normal operation from Low noise mode automatically in the case that the operation condition is severe.

Sound level of PQRY-P144TSLMU-A1/YSLMU-A1

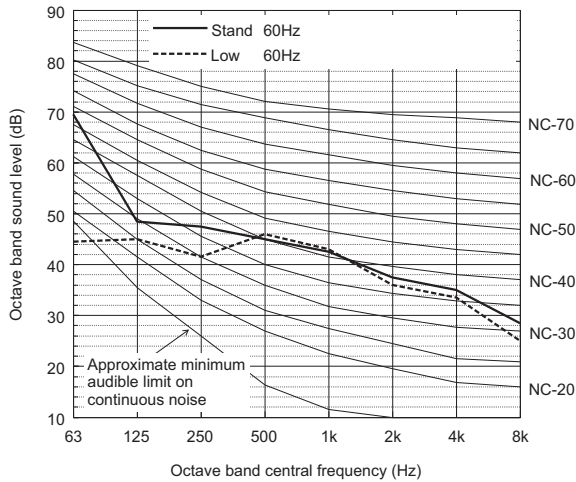

		63	125	250	500	1k	2k	4k	8k	dB(A)
Standard	60Hz	69.5	48.5	47.5	45.0	42.5	37.5	35.0	28.5	49.0
Low noise mode	60Hz	44.5	45.0	41.5	46.0	43.0	36.0	33.5	25.0	47.0

When Low noise mode is set, the A/C system's capacity is limited. The system could return to normal operation from Low noise mode automatically in the case that the operation condition is severe.

Sound level of PQRY-P216TSLMU-A1/YSLMU-A1

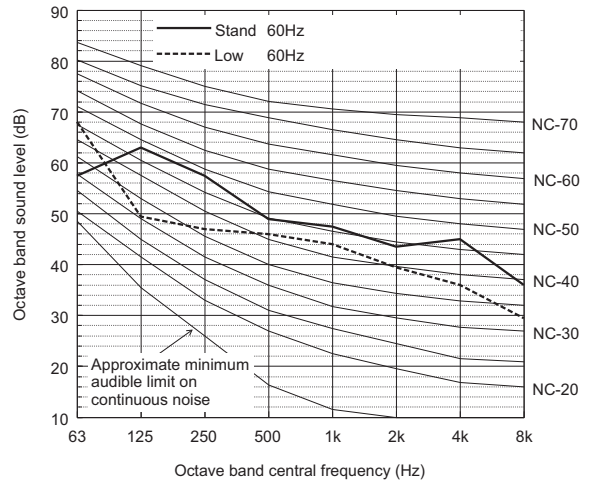

		63	125	250	500	1k	2k	4k	8k	dB(A)
Standard	60Hz	57.5	63.0	57.5	49.0	47.5	43.5	45.0	36.0	55.0
Low noise mode	60Hz	68.0	49.5	47.0	46.0	44.0	39.5	36.0	29.5	49.5

When Low noise mode is set, the A/C system's capacity is limited. The system could return to normal operation from Low noise mode automatically in the case that the operation condition is severe.

Sound level of PQRY-P168TSLMU-A1/YSLMU-A1

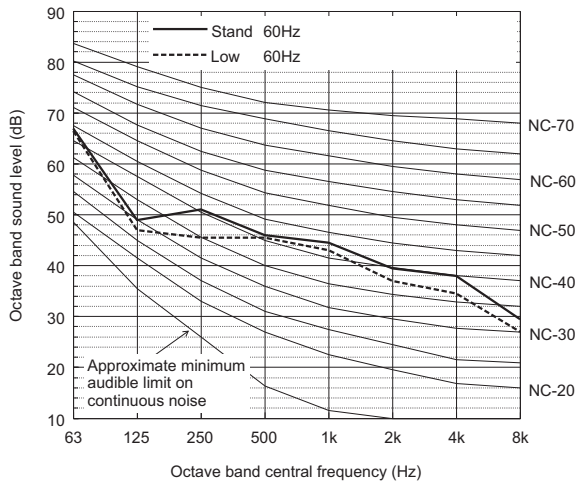

		63	125	250	500	1k	2k	4k	8k	dB(A)
Standard	60Hz	67.0	49.0	51.0	46.0	44.5	39.5	38.0	29.5	50.0
Low noise mode	60Hz	66.5	47.0	45.5	45.5	43.0	37.0	34.5	27.0	48.0

When Low noise mode is set, the A/C system's capacity is limited. The system could return to normal operation from Low noise mode automatically in the case that the operation condition is severe.

Sound level of PQRY-P240TSLMU-A1/YSLMU-A1

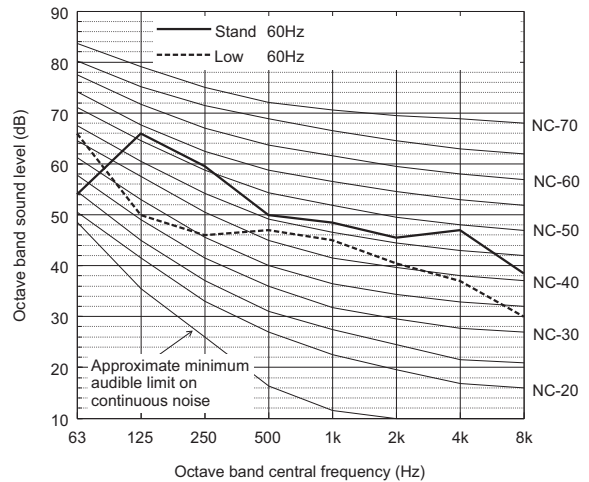

		63	125	250	500	1k	2k	4k	8k	dB(A)
Standard	60Hz	54.0	66.0	59.5	50.0	48.5	45.5	47.0	38.5	57.0
Low noise mode	60Hz	66.0	50.0	46.0	47.0	45.0	40.5	37.0	30.0	50.0

When Low noise mode is set, the A/C system's capacity is limited. The system could return to normal operation from Low noise mode automatically in the case that the operation condition is severe.

- ◆ Depending on the operation conditions, the unit generates noise caused by valve actuation, refrigerant flow, and pressure changes when operating normally. Please consider to avoid location where quietness is required. For BC controller, it is recommended to be installed in places such as ceilings of corridor, rest rooms and plant rooms.

Measurement condition
PQRY-P288, 312, 336TSLMU-A1/YSLMU-A1

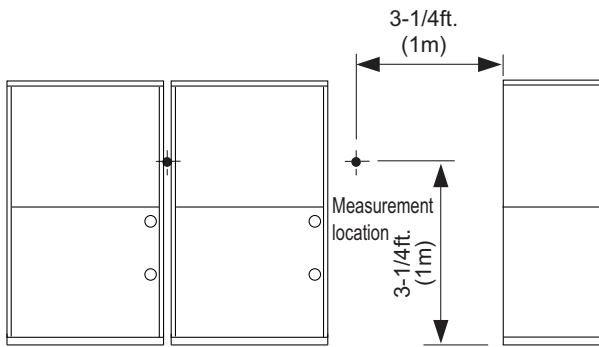

Sound level of PQRY-P336TSLMU-A1/YSLMU-A1

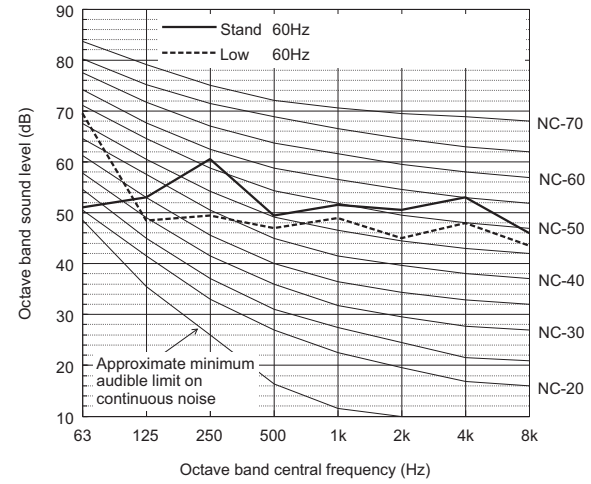

		63	125	250	500	1k	2k	4k	8k	dB(A)
Standard	60Hz	51.0	53.0	60.5	49.5	51.5	50.5	53.0	46.0	59.0
Low noise mode	60Hz	69.5	48.5	49.5	47.0	49.0	45.0	48.0	43.5	54.5

When Low noise mode is set, the A/C system's capacity is limited. The system could return to normal operation from Low noise mode automatically in the case that the operation condition is severe.

Sound level of PQRY-P288TSLMU-A1/YSLMU-A1

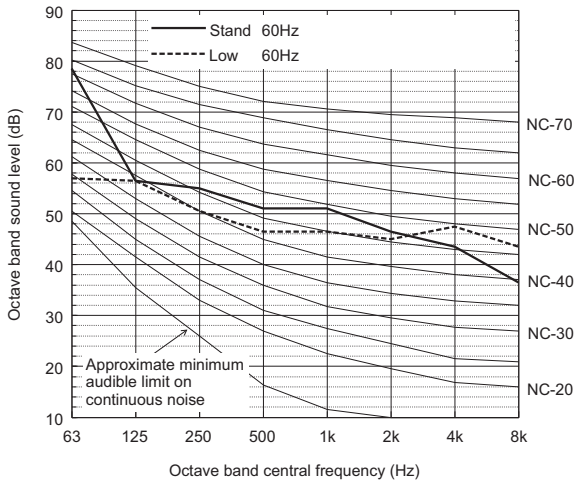

		63	125	250	500	1k	2k	4k	8k	dB(A)
Standard	60Hz	78.5	56.5	55.0	51.0	51.0	46.5	43.5	36.5	57.0
Low noise mode	60Hz	57.0	56.5	50.5	46.5	46.5	45.0	47.5	43.5	53.5

When Low noise mode is set, the A/C system's capacity is limited. The system could return to normal operation from Low noise mode automatically in the case that the operation condition is severe.

Sound level of PQRY-P312TSLMU-A1/YSLMU-A1

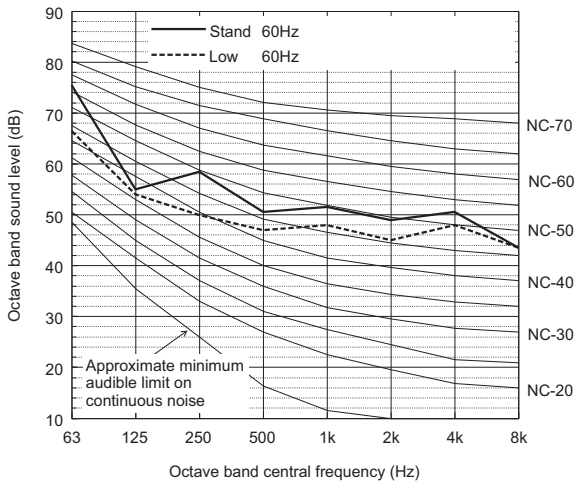

		63	125	250	500	1k	2k	4k	8k	dB(A)
Standard	60Hz	75.5	55.0	58.5	50.5	51.5	49.0	50.5	43.5	58.0
Low noise mode	60Hz	66.5	54.0	50.0	47.0	48.0	45.0	48.0	43.5	54.0

When Low noise mode is set, the A/C system's capacity is limited. The system could return to normal operation from Low noise mode automatically in the case that the operation condition is severe.

- Depending on the operation conditions, the unit generates noise caused by valve actuation, refrigerant flow, and pressure changes when operating normally. Please consider to avoid location where quietness is required. For BC controller, it is recommended to be installed in places such as ceilings of corridor, rest rooms and plant rooms.

• Cooling

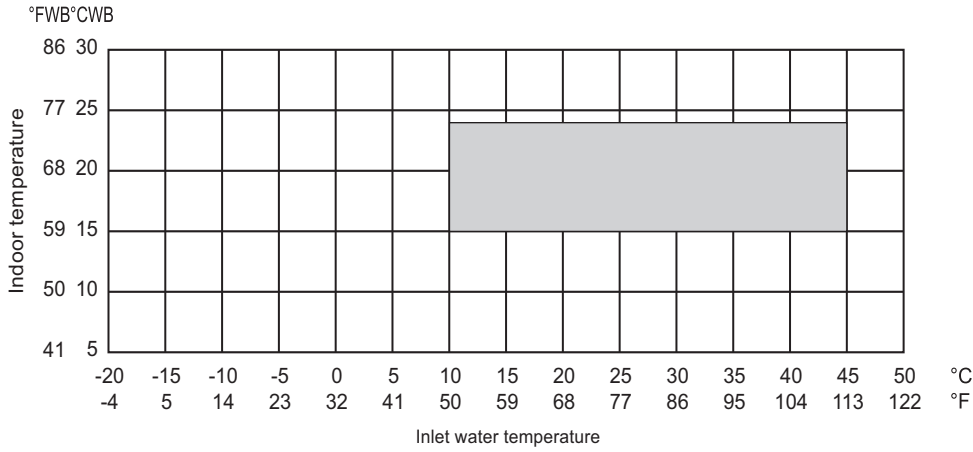

• Heating

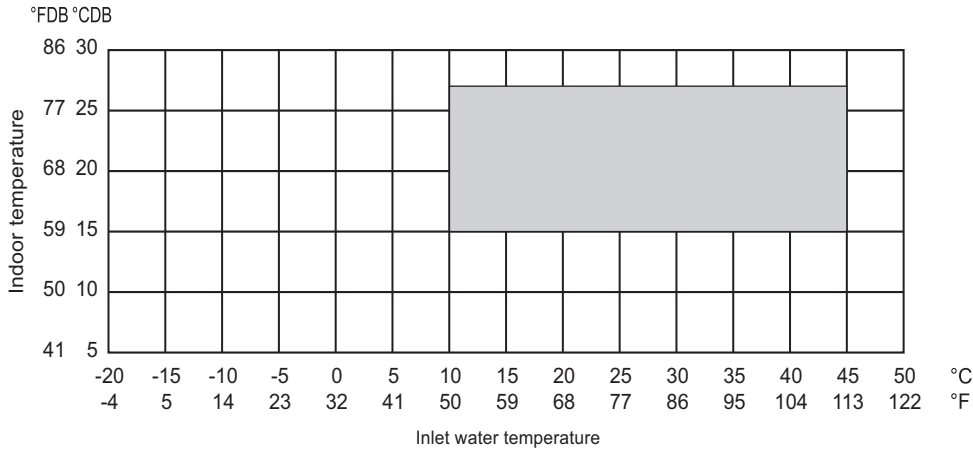

• Combination of cooling/heating operation (Cooling main or Heating main)

Inlet water temperature	Indoor temperature	
	Cooling	Heating
10 to 45°C (50 to 113°F)	15 to 24°CWB (59 to 75°FWB)	15 to 27°CDB (59 to 81°FDB)

* The upper limit of the outlet water temperature is approximately 70°C (158°F) when the circulating-water flow rate is within the normal range.
 If the circulating-water flow rate goes outside the normal range, the outlet water temperature may exceed the above limit.

7-1. Correction by temperature

CITY MULTI could have varied capacity at different designing temperature. Using the nominal cooling/heating capacity value and the ratio below, the capacity can be observed at various temperature.

PQRY-P-T(S)LMU-A1, Y(S)LMU-A1

PQRY-		P72TLMU/YLMU
Nominal Cooling Capacity	kW	21.1
	BTU/h	72,000
Input	kW	3.61

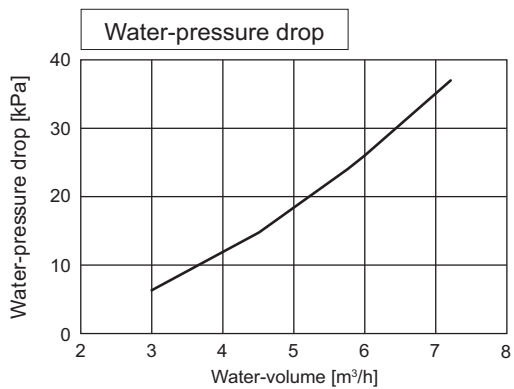
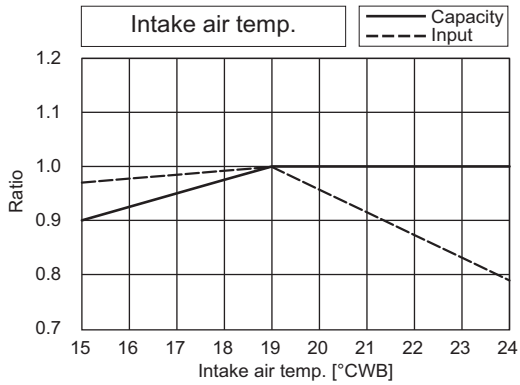
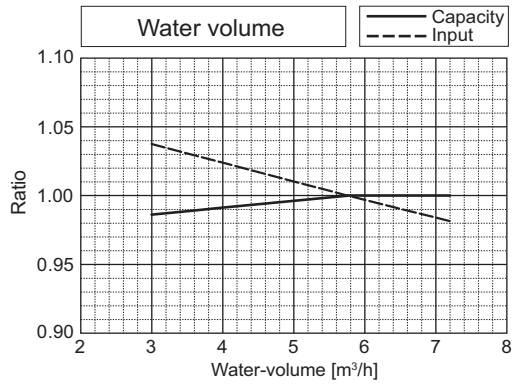
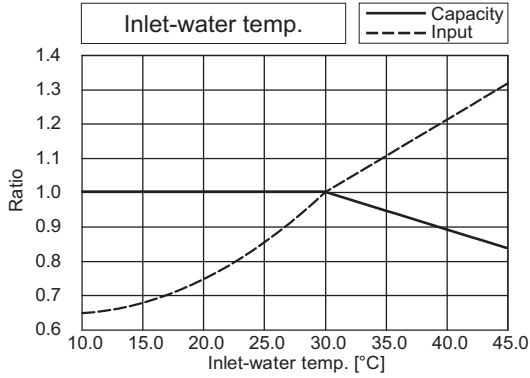

PQRY-		P72TLMU/YLMU
Nominal Heating Capacity	kW	23.4
	BTU/h	80,000
Input	kW	4.04

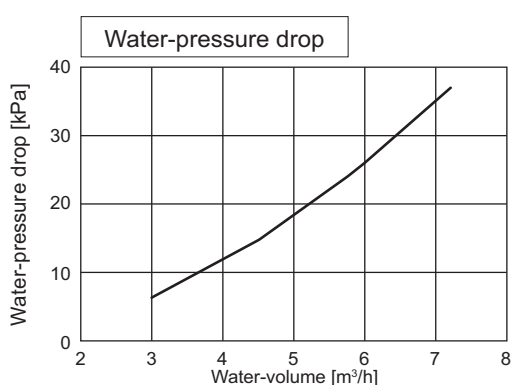
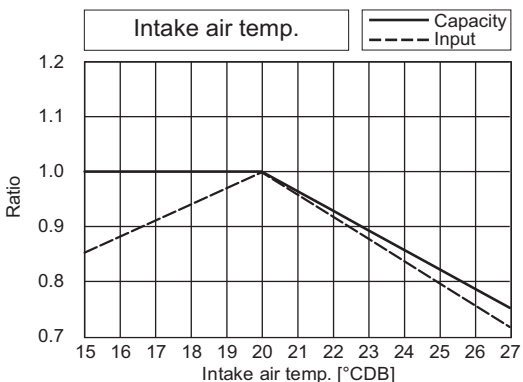
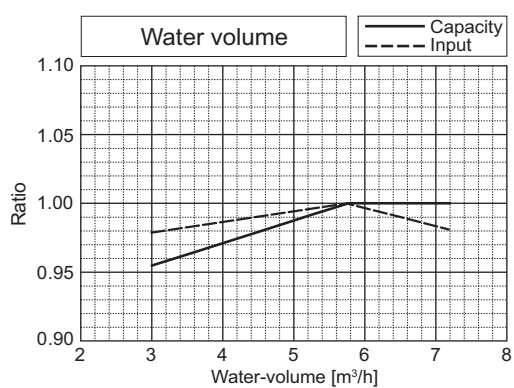
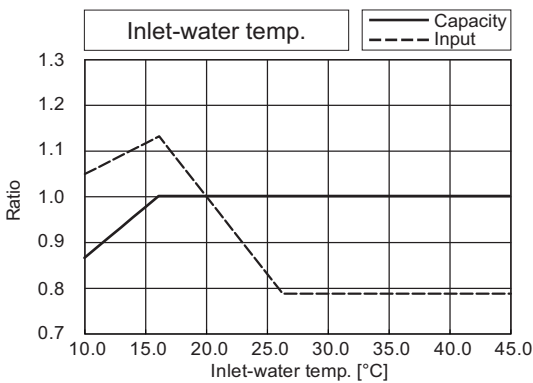

PQRY-		P96TLMU/YLMU
Nominal Cooling Capacity	kW	28.1
	BTU/h	96,000
Input	kW	5.21

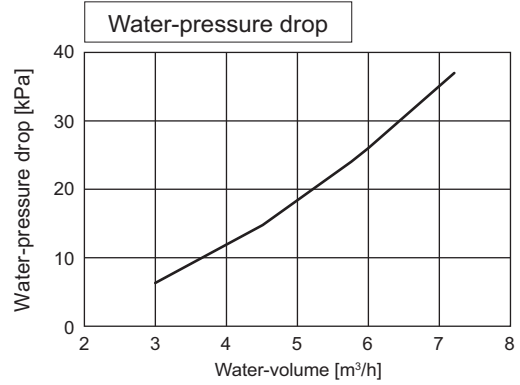
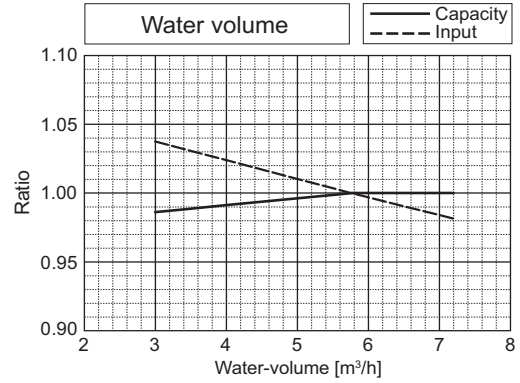
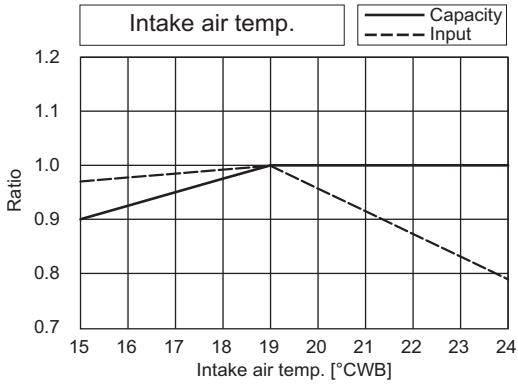
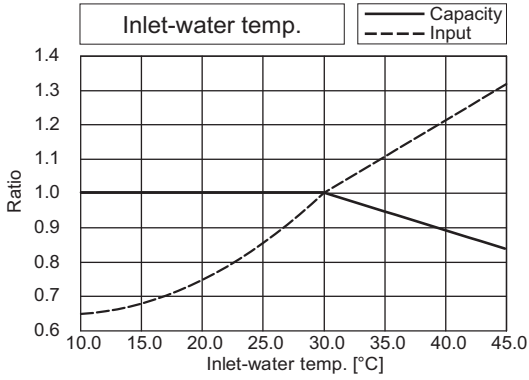

PQRY-		P96TLMU/YLMU
Nominal Heating Capacity	kW	31.7
	BTU/h	108,000
Input	kW	5.64

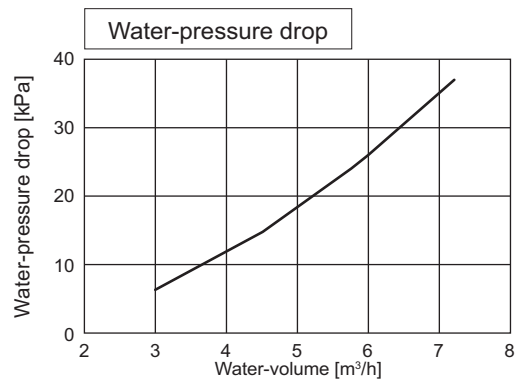
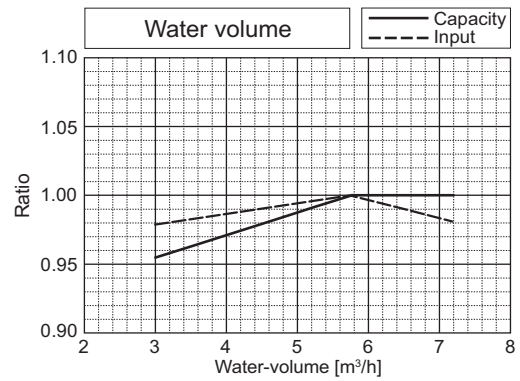
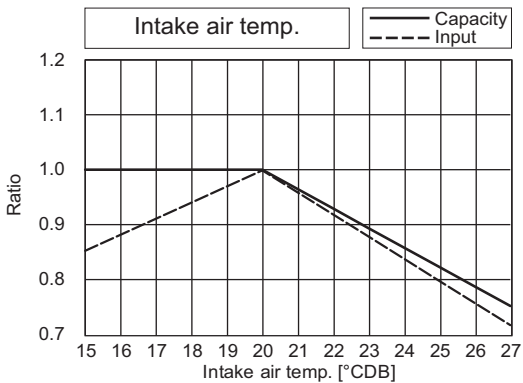
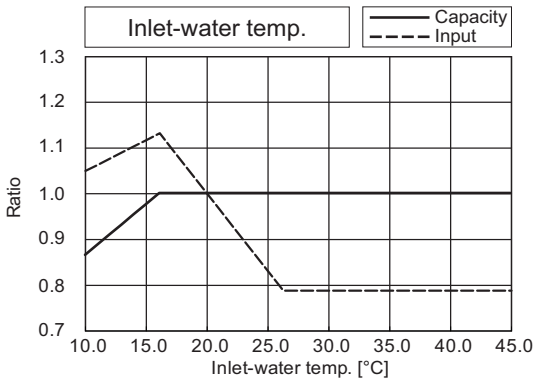

PQRY-P-T(S)LMU-A1, Y(S)LMU-A1

7. CAPACITY TABLES

PQRY-P-T(S)LMU-A1, Y(S)LMU-A1

PQRY-		P120TLMU/YLMU
Nominal Cooling Capacity	kW	35.2
	BTU/h	120,000
Input	kW	7.51

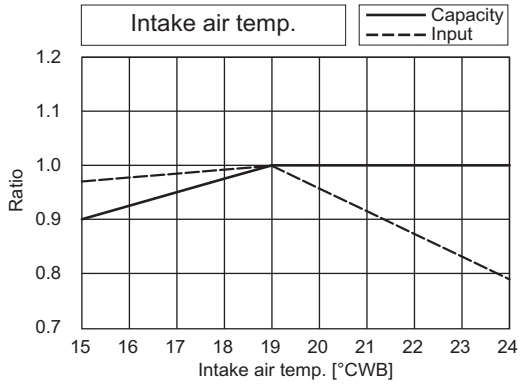
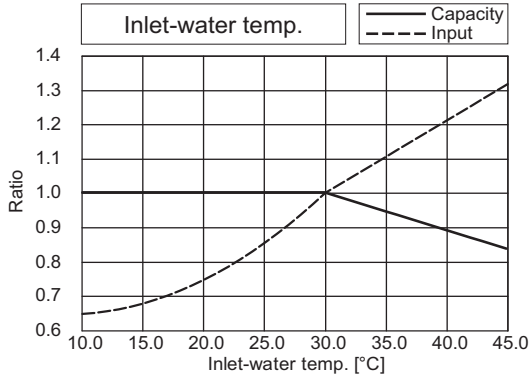

PQRY-		P120TLMU/YLMU
Nominal Heating Capacity	kW	39.6
	BTU/h	135,000
Input	kW	7.09

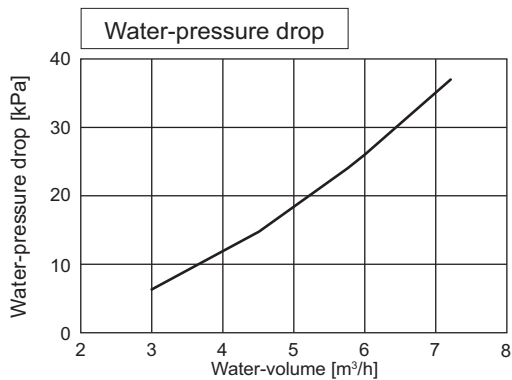
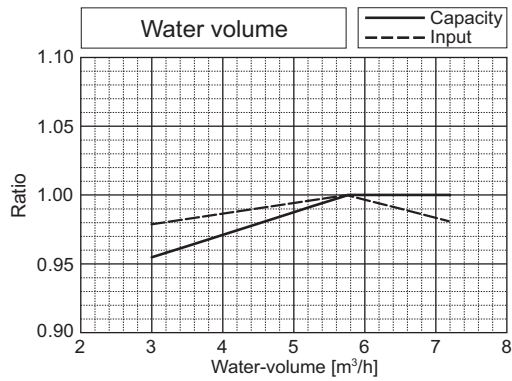
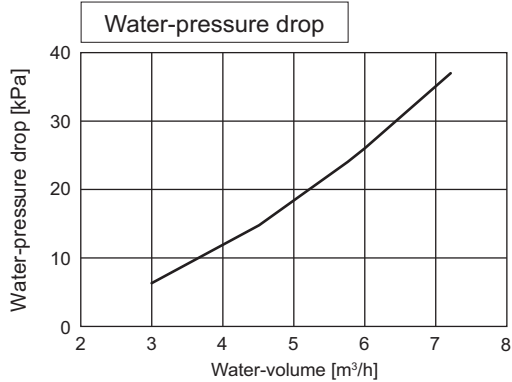
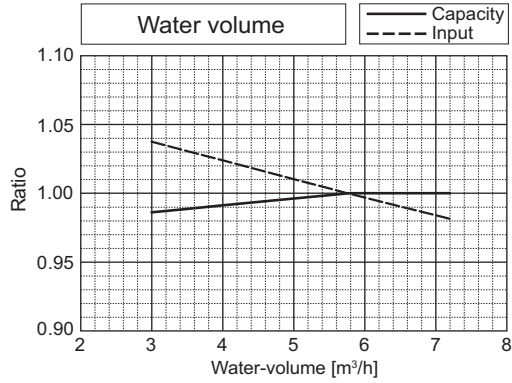
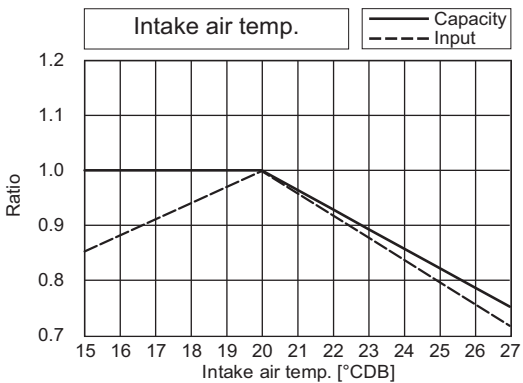
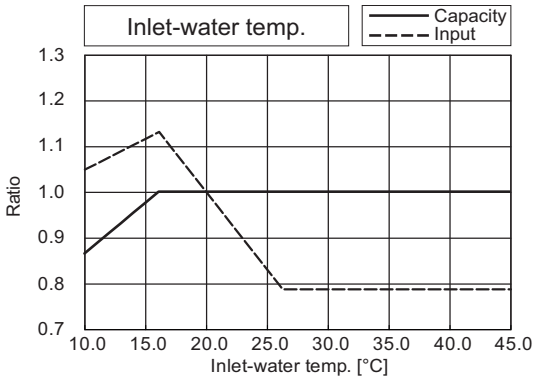

PQRY-		P144TLMU/YLMU
Nominal Cooling Capacity	kW	42.2
	BTU/h	144,000
Input	kW	8.78

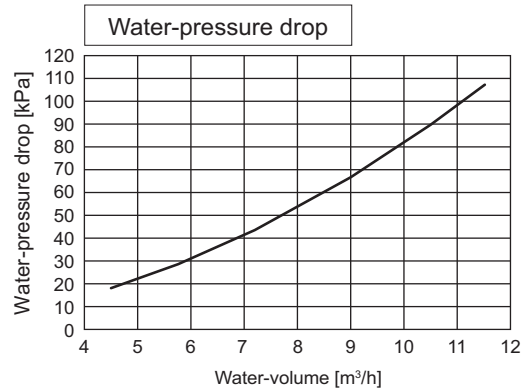
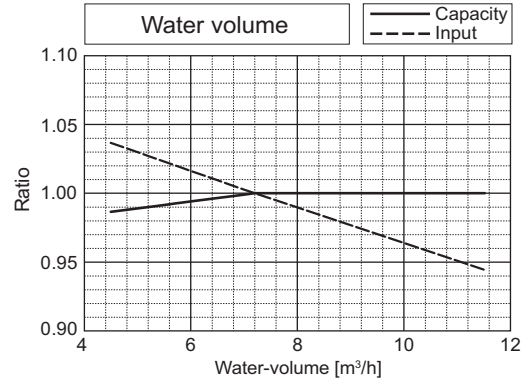
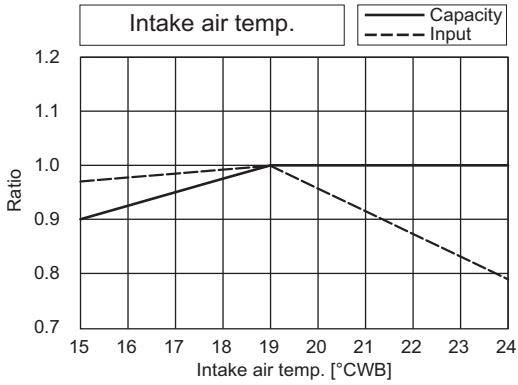
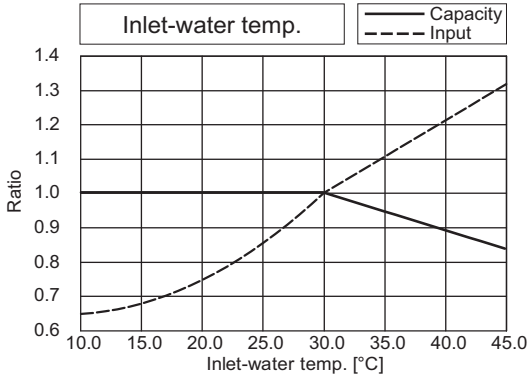

PQRY-		P144TLMU/YLMU
Nominal Heating Capacity	kW	46.9
	BTU/h	160,000
Input	kW	8.11

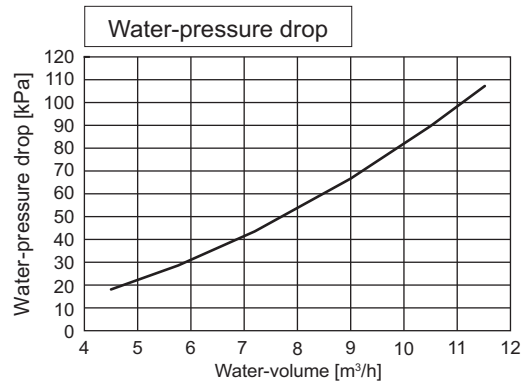
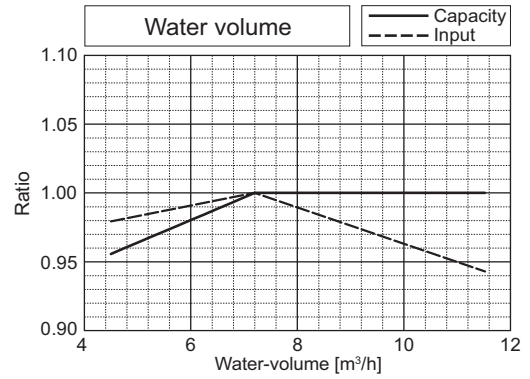
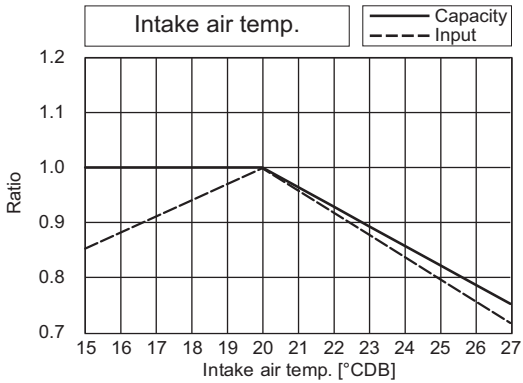
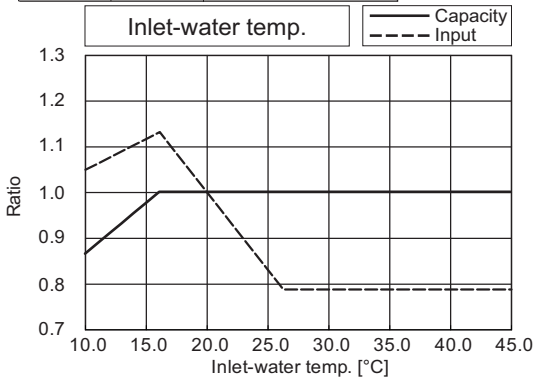

PQRY-P-T(S)LMU-A1, Y(S)LMU-A1

PQRY-P-T(S)LMU-A1, Y(S)LMU-A1

PQRY-		P168TLMU/YLMU
Nominal Cooling Capacity	kW	49.2
	BTU/h	168,000
Input	kW	12.05

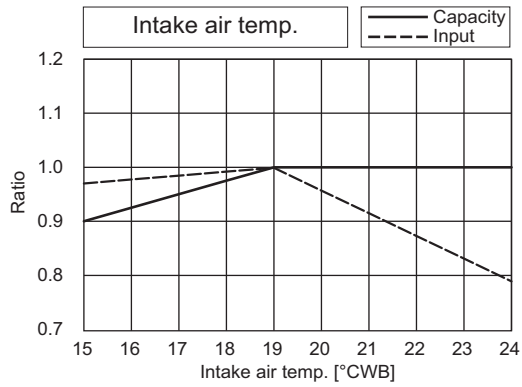
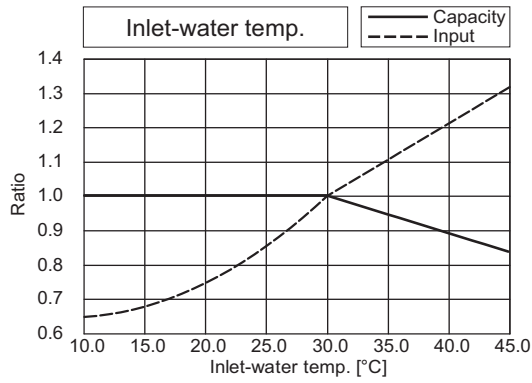

PQRY-		P168TLMU/YLMU
Nominal Heating Capacity	kW	55.1
	BTU/h	188,000
Input	kW	9.86

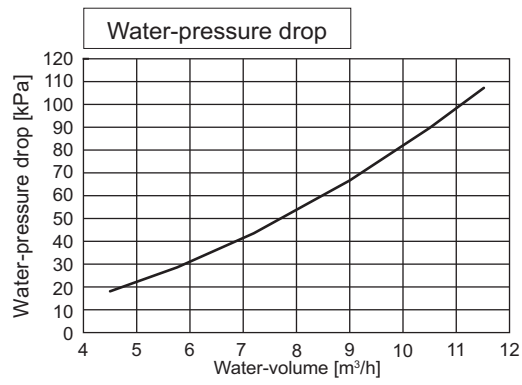
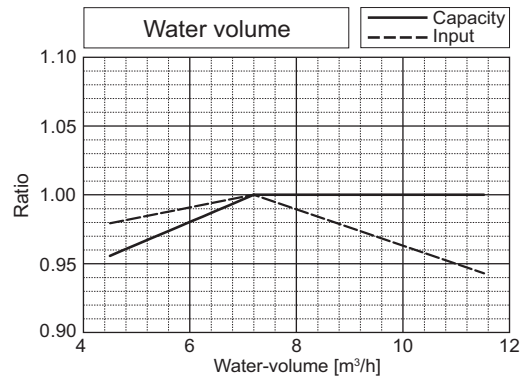
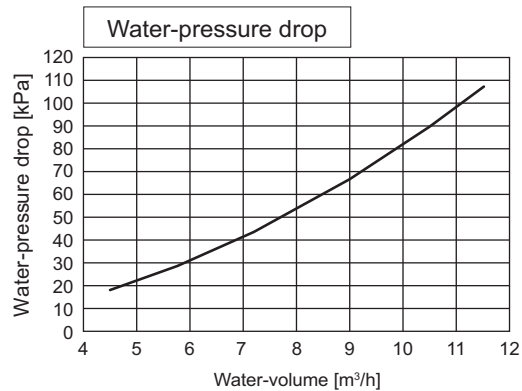
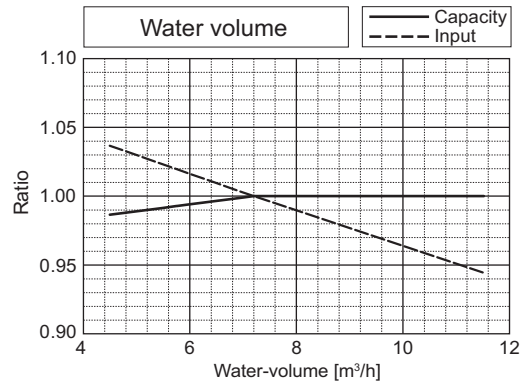
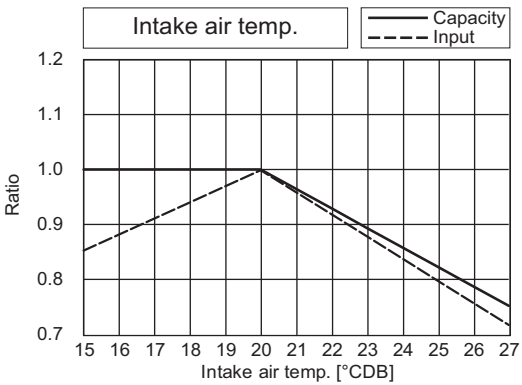
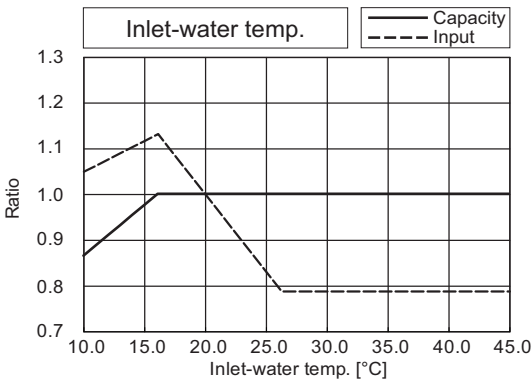

PQRY-		P192TLMU/YLMU
Nominal Cooling Capacity	kW	56.3
	BTU/h	192,000
Input	kW	15.05

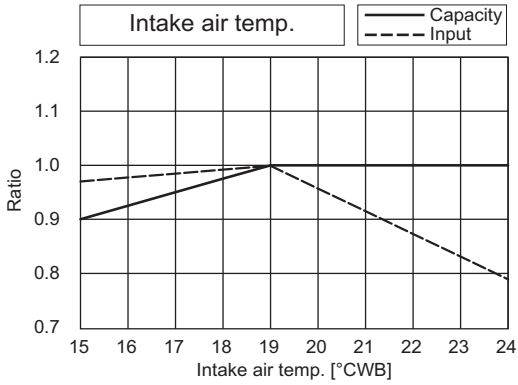
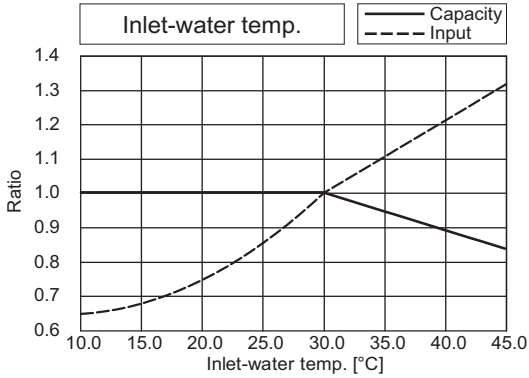

PQRY-		P192TLMU/YLMU
Nominal Heating Capacity	kW	63.0
	BTU/h	215,000
Input	kW	11.90

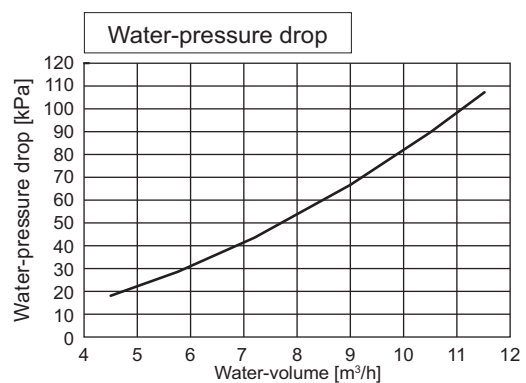
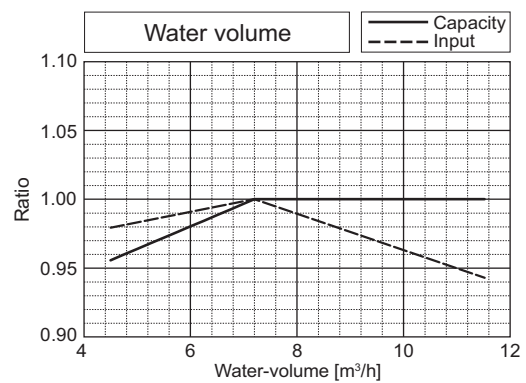
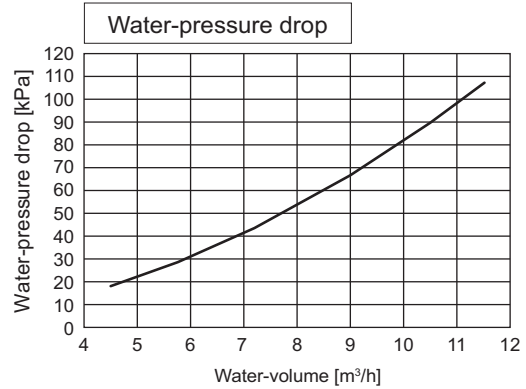
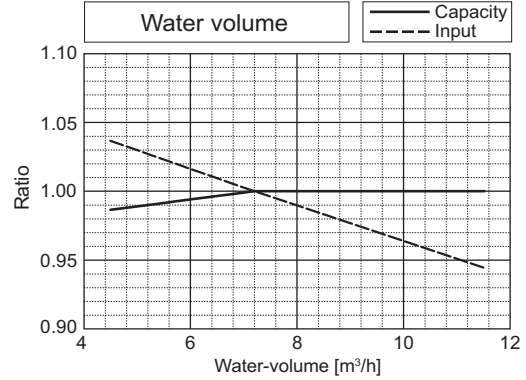
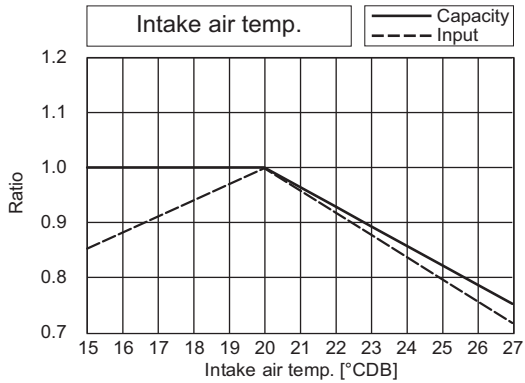
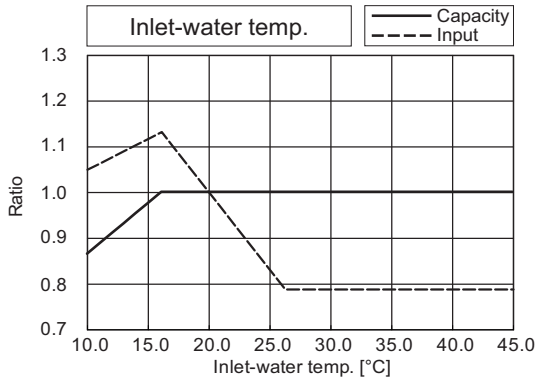

PQRY-P-T(S)LMU-A1, Y(S)LMU-A1

PQRY-		P216TLMU/YLMU
Nominal Cooling Capacity	kW	63.3
	BTU/h	216,000
Input	kW	19.23

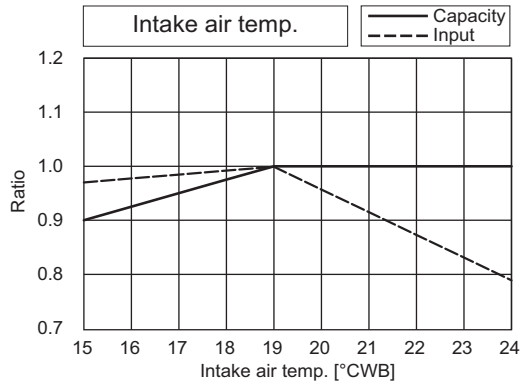
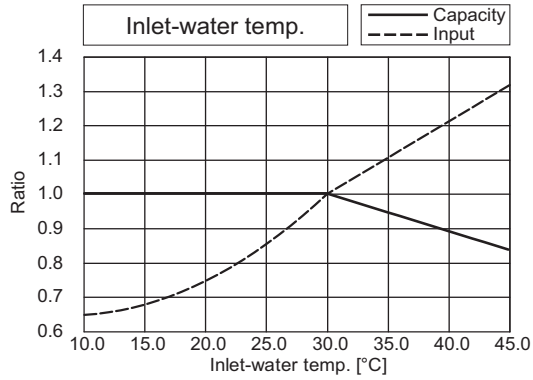

PQRY-		P216TLMU/YLMU
Nominal Heating Capacity	kW	71.2
	BTU/h	243,000
Input	kW	13.04

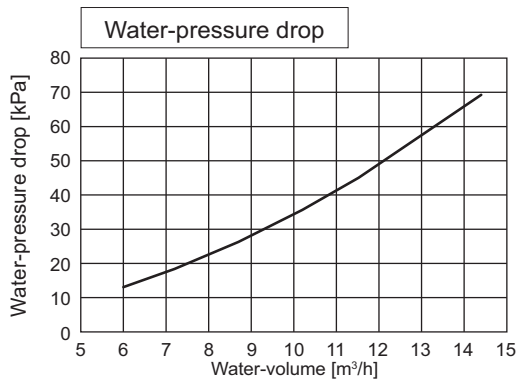
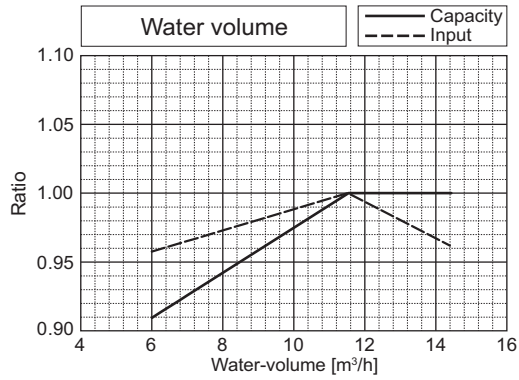
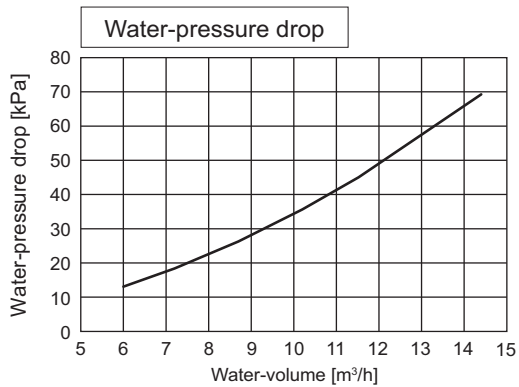
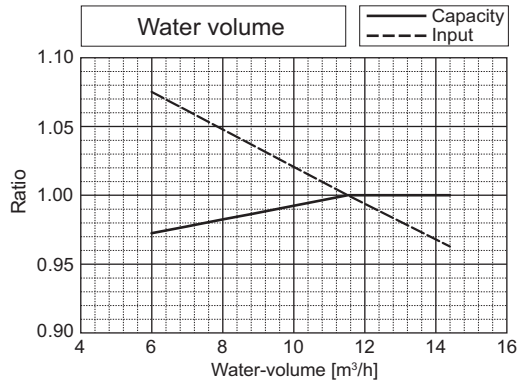
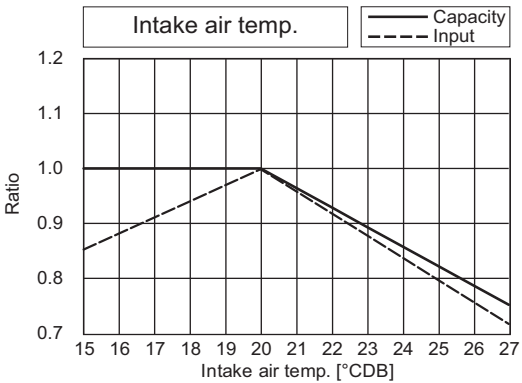
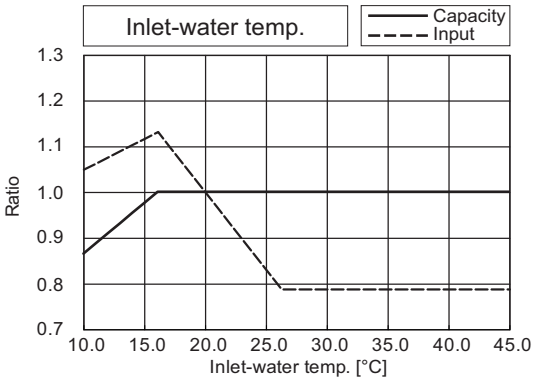

PQRY-		P240TLMU/YLMU
Nominal Cooling Capacity	kW	65.7
	BTU/h	224,000
Input	kW	21.14

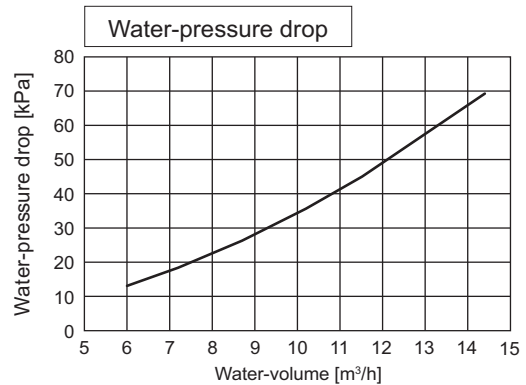
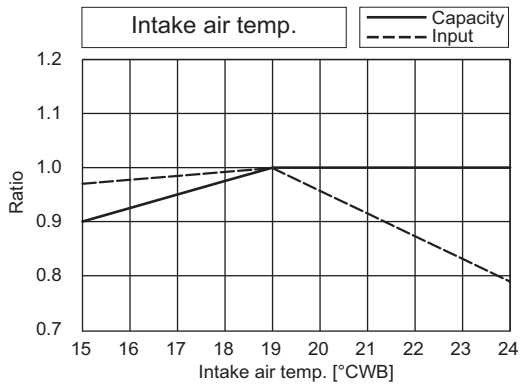
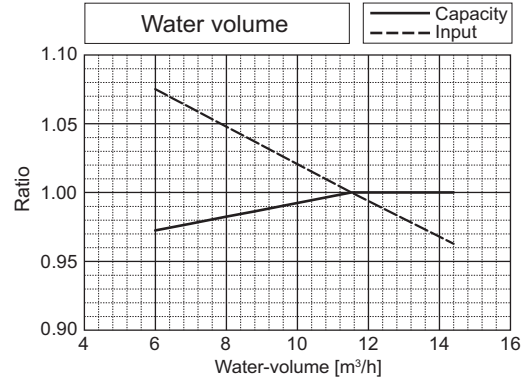
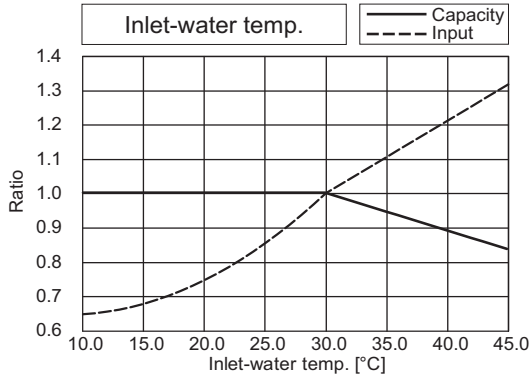

PQRY-		P240TLMU/YLMU
Nominal Heating Capacity	kW	79.1
	BTU/h	270,000
Input	kW	15.12

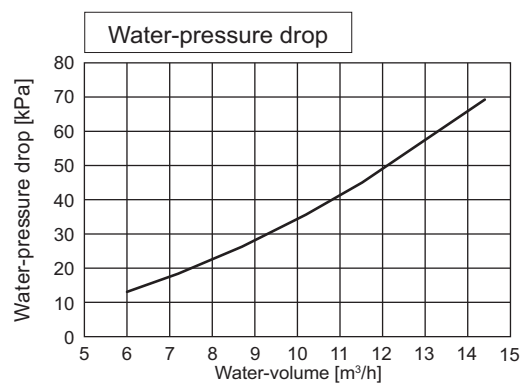
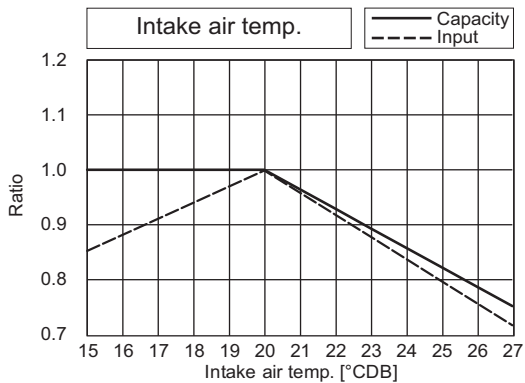
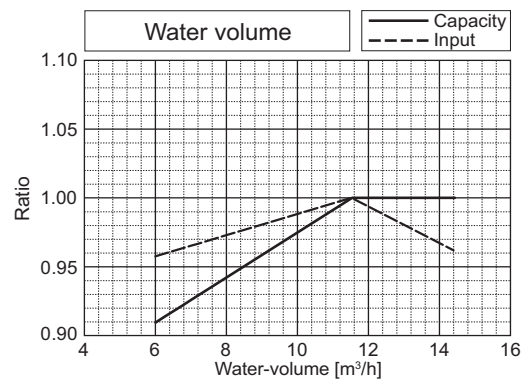
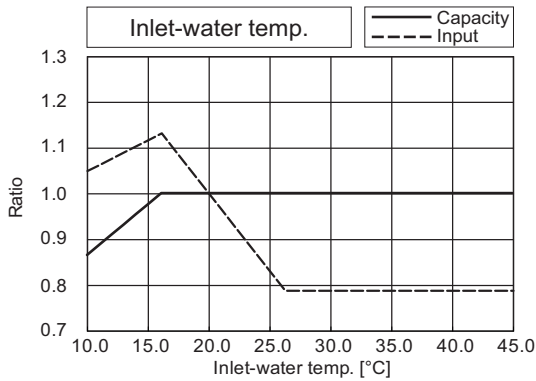

7. CAPACITY TABLES

PQRY-P-T(S)LMU-A1, Y(S)LMU-A1

*The drawing indicates characteristic per unit.

PQRY-		P144TSLMU/YSLMU
Nominal Cooling Capacity	kW	42.2
	BTU/h	144,000
Input	kW	7.11

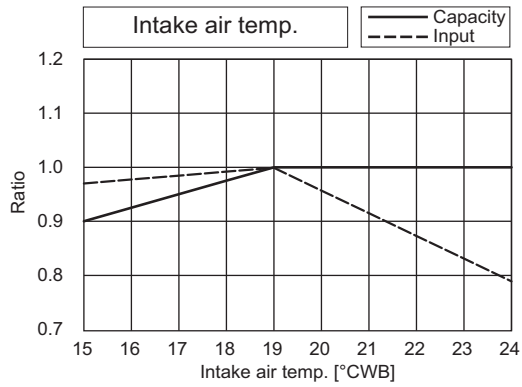
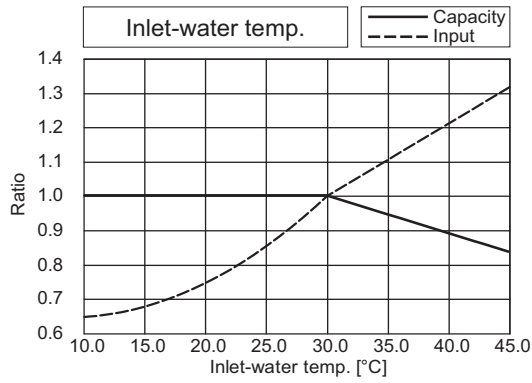

PQRY-		P144TSLMU/YSLMU
Nominal Heating Capacity	kW	46.9
	BTU/h	160,000
Input	kW	7.45

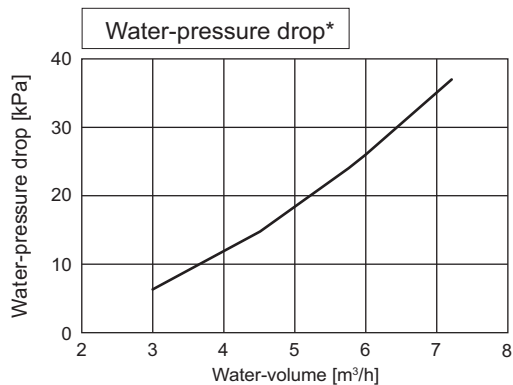
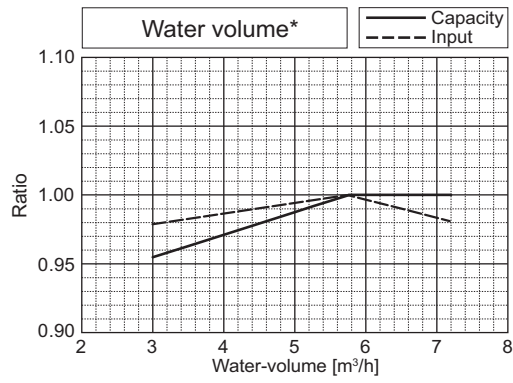
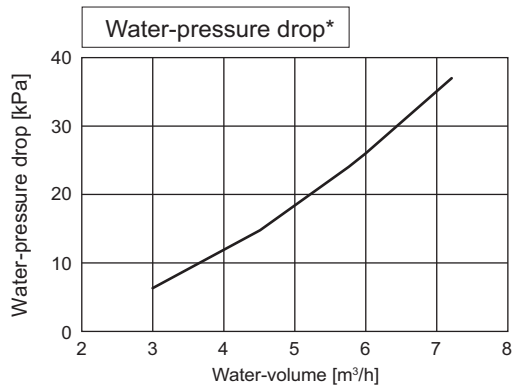
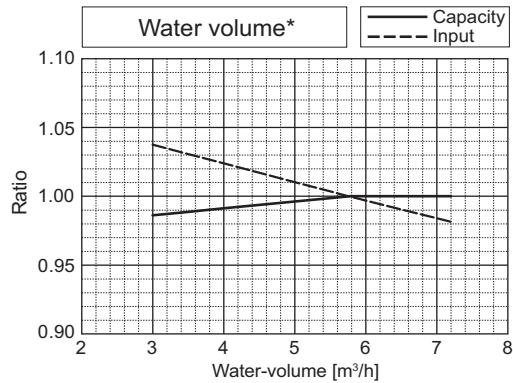
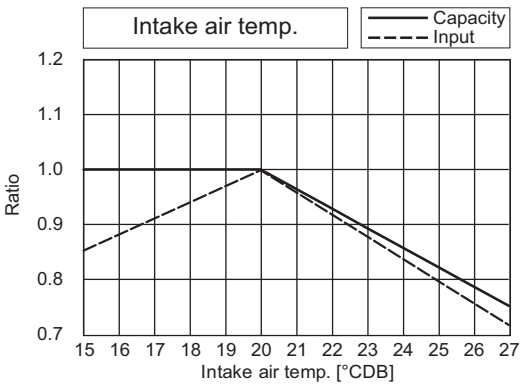
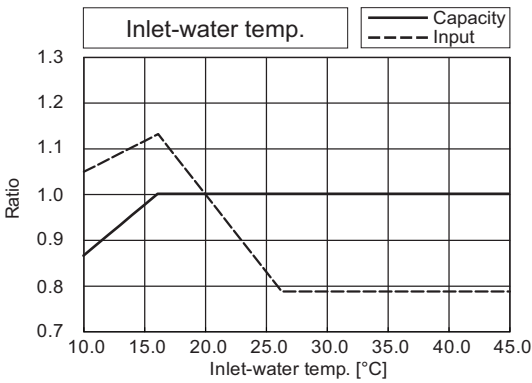

PQRY-		P168TSLMU/YSLMU
Nominal Cooling Capacity	kW	49.2
	BTU/h	168,000
Input	kW	9.33

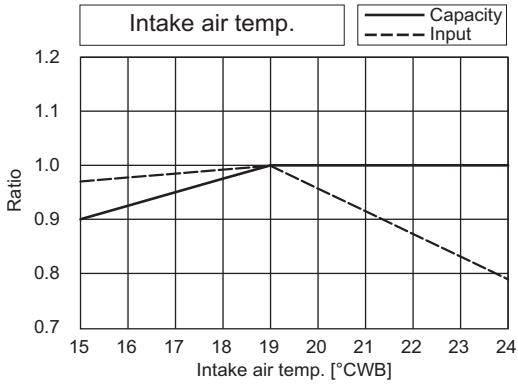
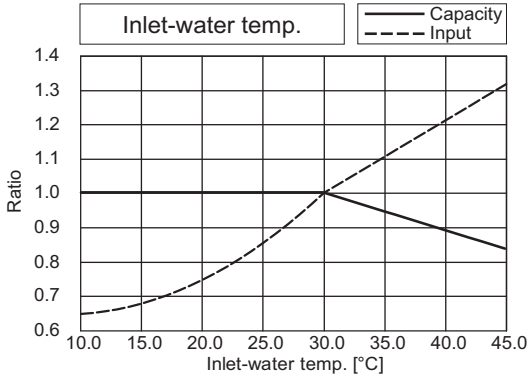

PQRY-		P168TSLMU/YSLMU
Nominal Heating Capacity	kW	55.1
	BTU/h	188,000
Input	kW	9.34

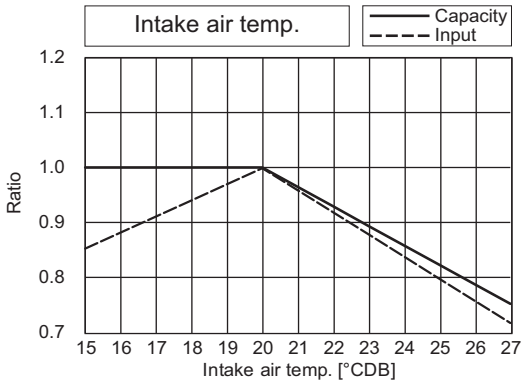
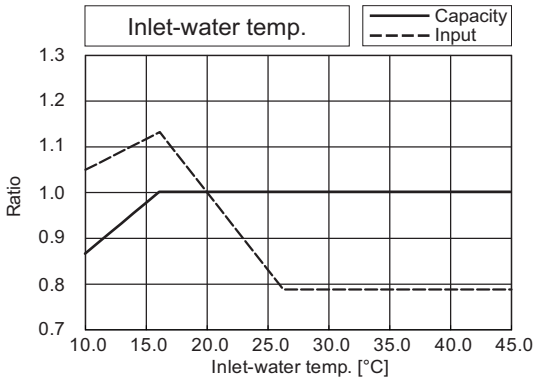

*The drawing indicates characteristic per unit.

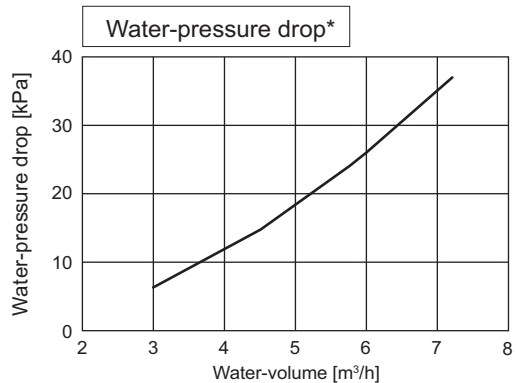
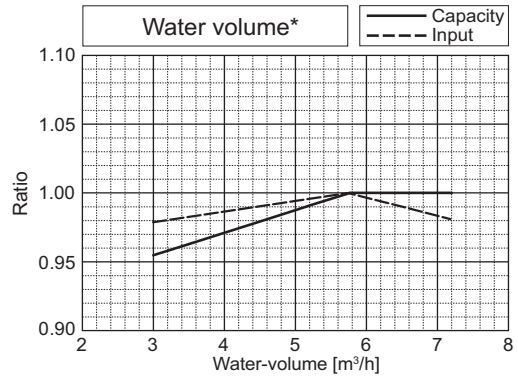
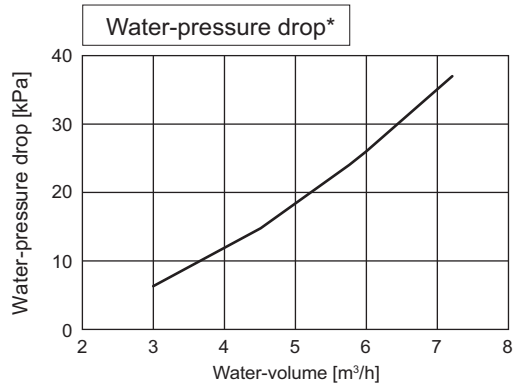
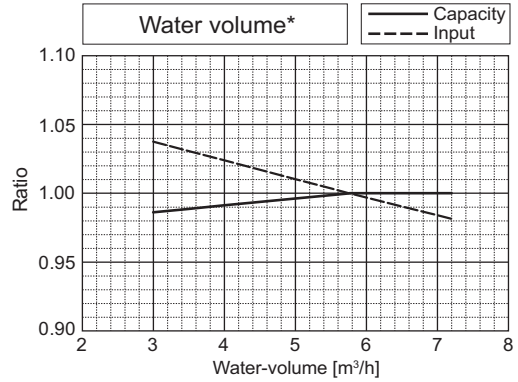

PQRY-P-T(S)LMU-A1, Y(S)LMU-A1

7. CAPACITY TABLES

PQRY-P-T(S)LMU-A1, Y(S)LMU-A1

PQRY-		P192TSLMU/YSLMU
Nominal Cooling Capacity	kW	56.3
	BTU/h	192,000
Input	kW	11.30

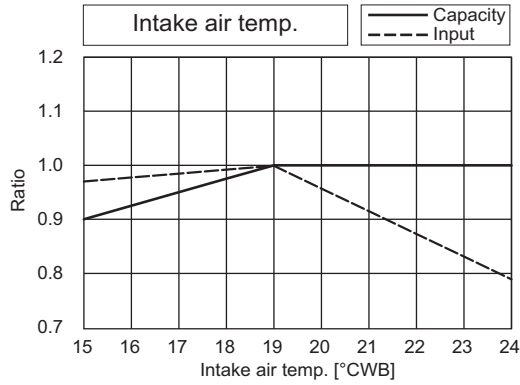
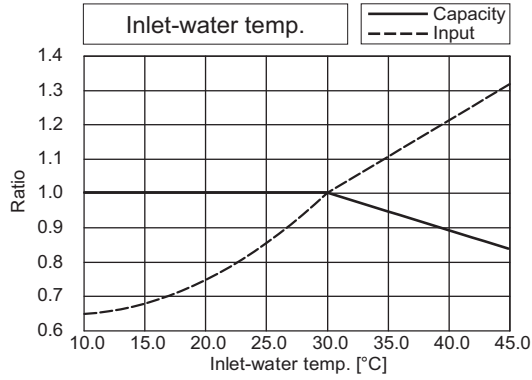

PQRY-		P192TSLMU/YSLMU
Nominal Heating Capacity	kW	63.0
	BTU/h	215,000
Input	kW	11.02

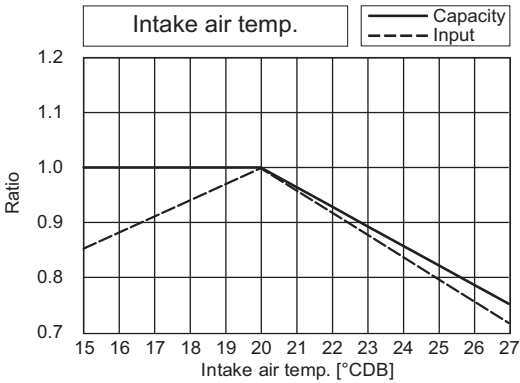
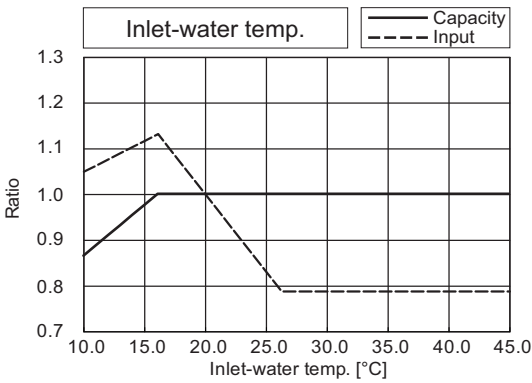

*The drawing indicates characteristic per unit.

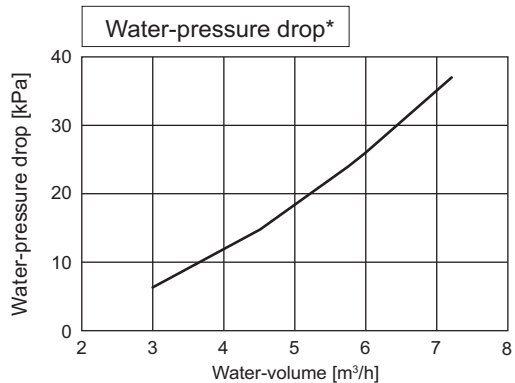
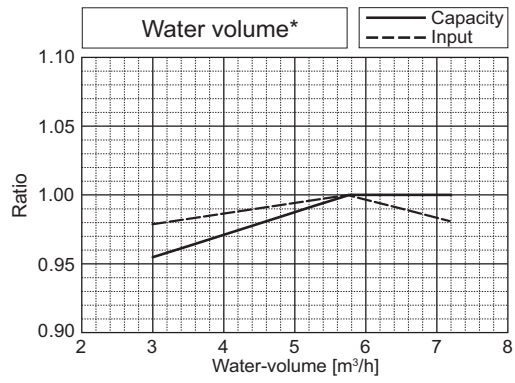
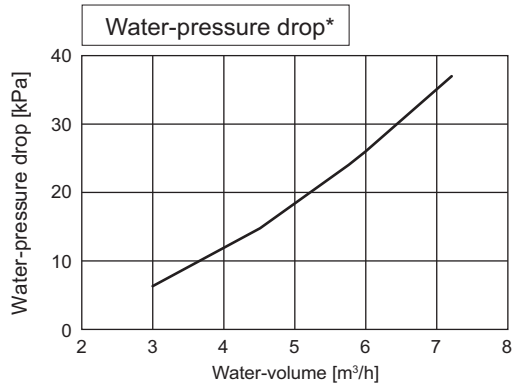
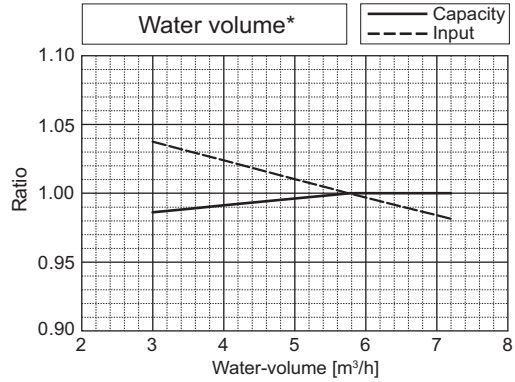

PQRY-		P216TSLMU/YSLMU
Nominal Cooling Capacity	kW	63.3
	BTU/h	216,000
Input	kW	14.03

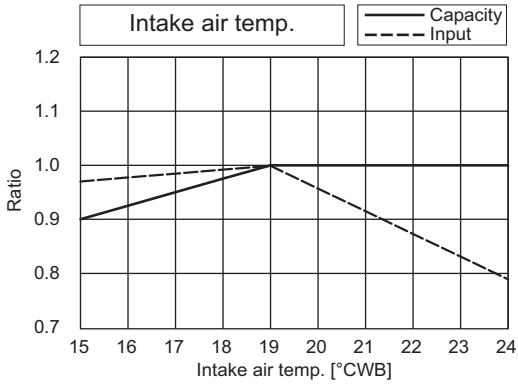
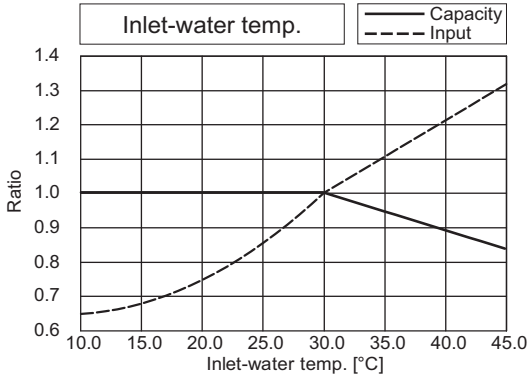

PQRY-		P216TSLMU/YSLMU
Nominal Heating Capacity	kW	71.2
	BTU/h	243,000
Input	kW	12.88

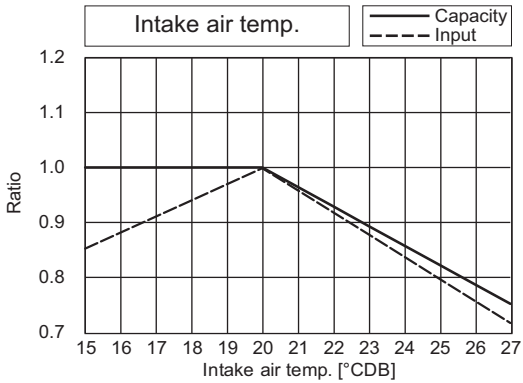
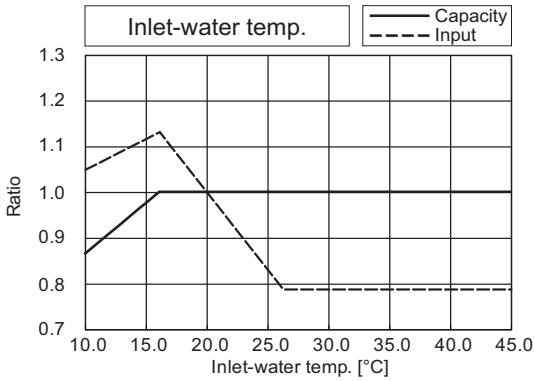

*The drawing indicates characteristic per unit.

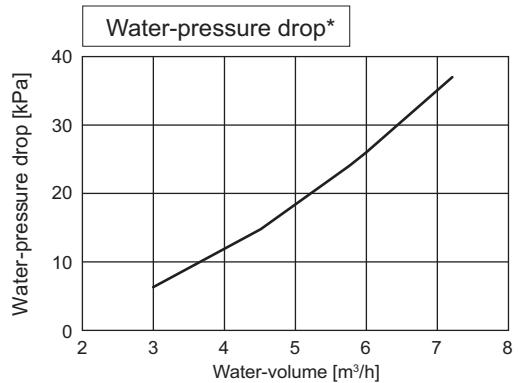
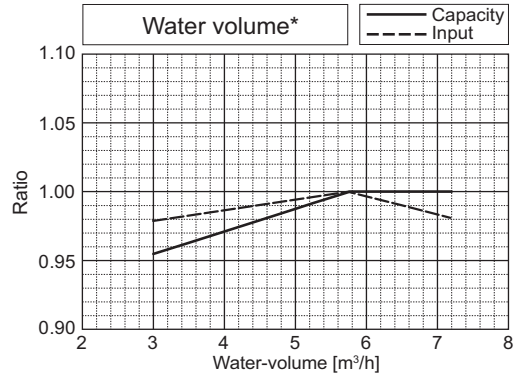
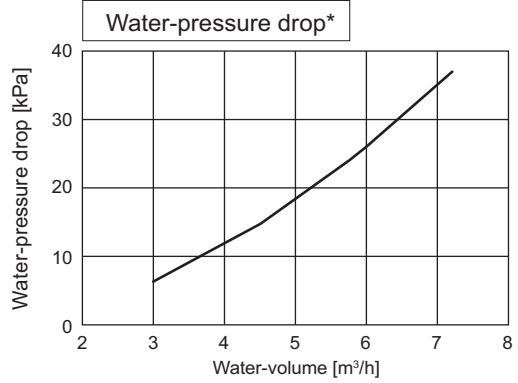
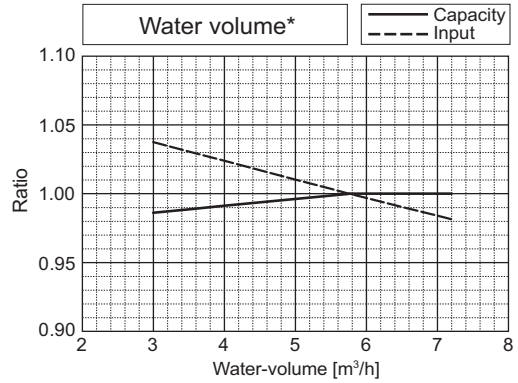

PQRY-P-T(S)LMU-A1, Y(S)LMU-A1

7. CAPACITY TABLES

PQRY-P-T(S)LMU-A1, Y(S)LMU-A1

*The drawing indicates characteristic per unit.

PQRY-		P240TSLMU/YSLMU
Nominal Cooling Capacity	kW	70.3
	BTU/h	240,000
Input	kW	16.89

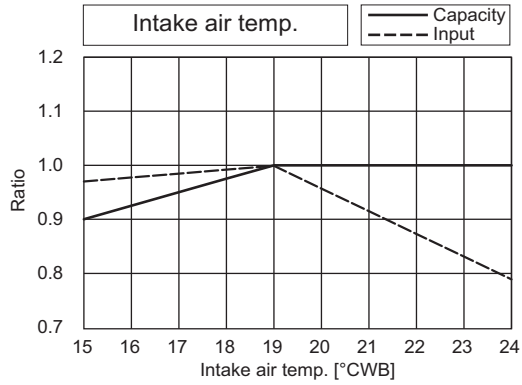
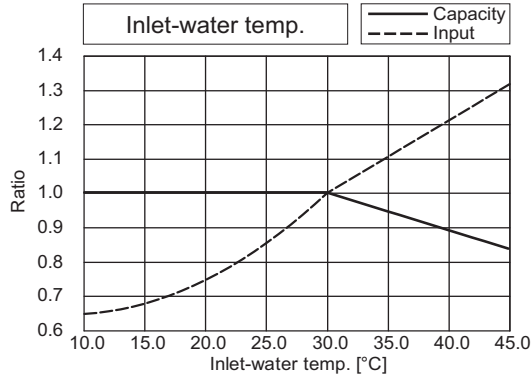

PQRY-		P240TSLMU/YSLMU
Nominal Heating Capacity	kW	79.1
	BTU/h	270,000
Input	kW	14.58

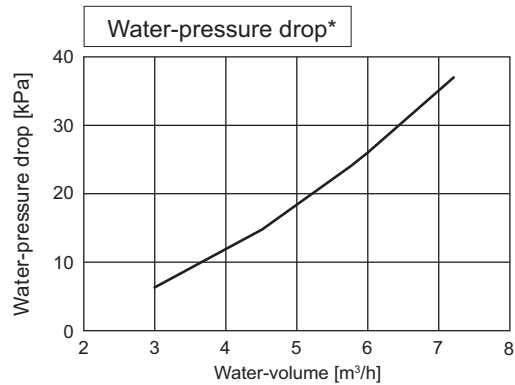
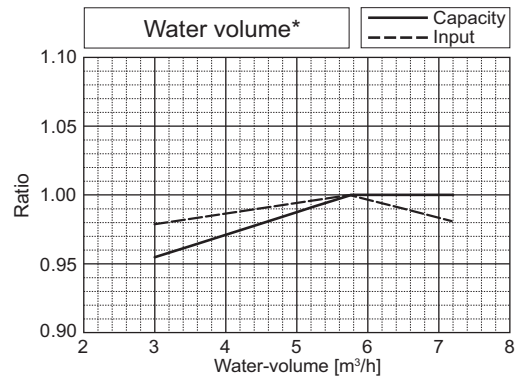
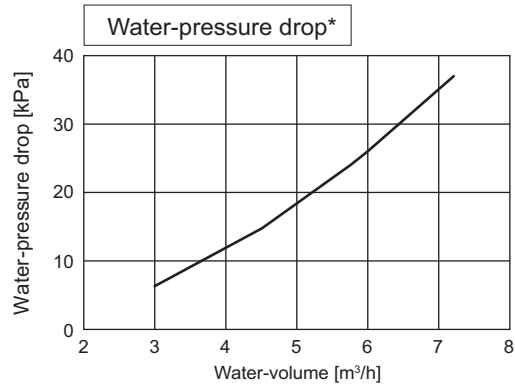
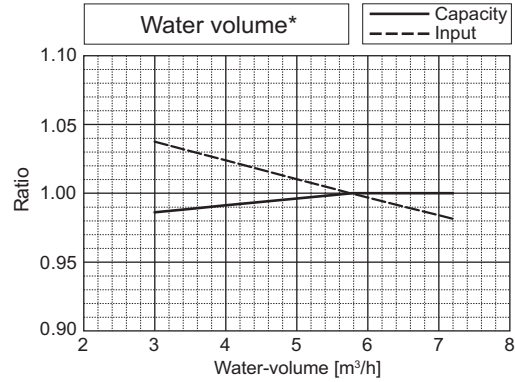
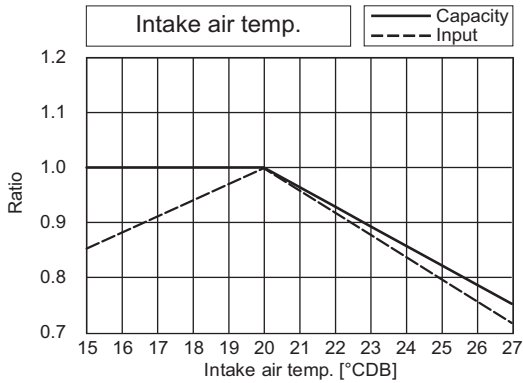
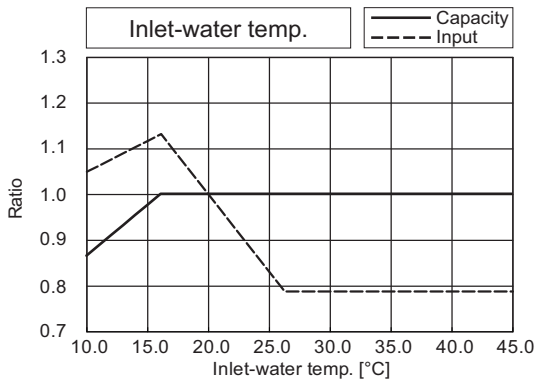

PQRY-		P288TSLMU/YSLMU
Nominal Cooling Capacity	kW	84.4
	BTU/h	288,000
Input	kW	20.42

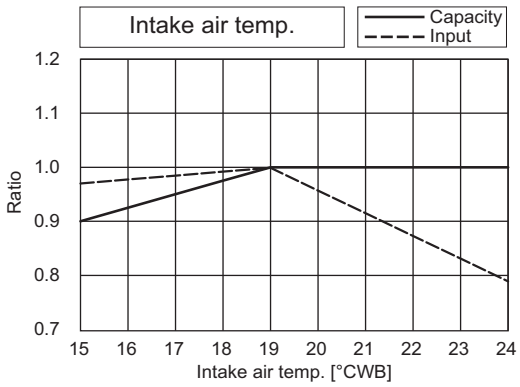
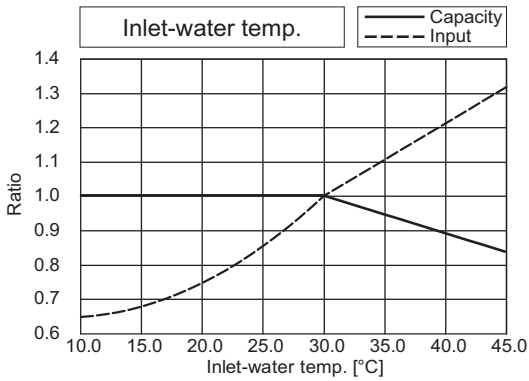

PQRY-		P288TSLMU/YSLMU
Nominal Heating Capacity	kW	94.7
	BTU/h	323,000
Input	kW	17.50

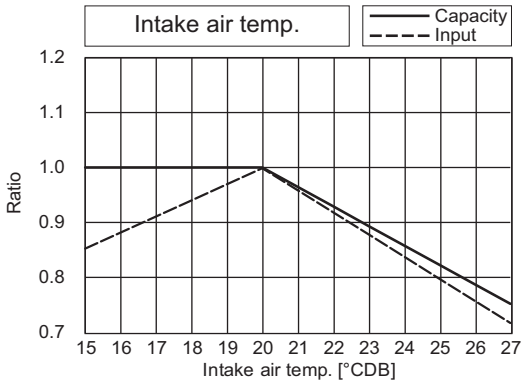
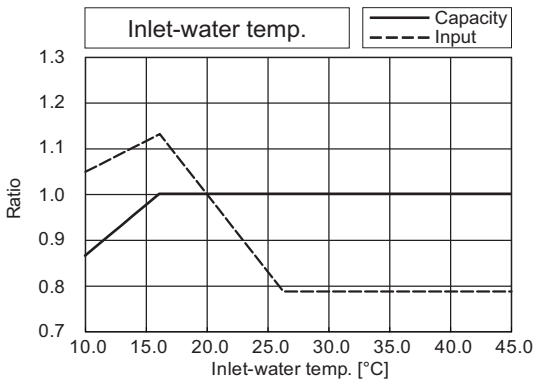

*The drawing indicates characteristic per unit.

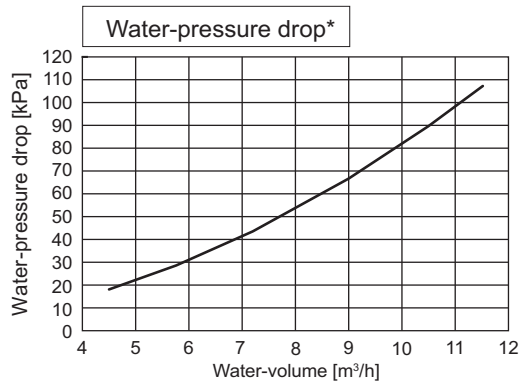
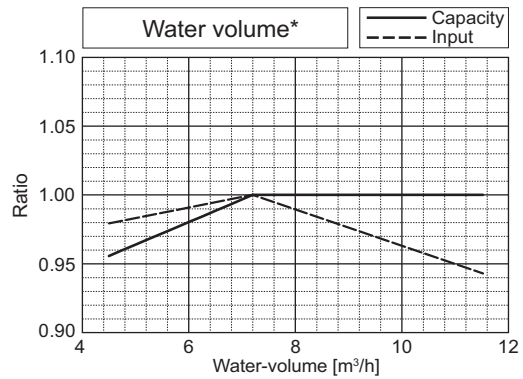
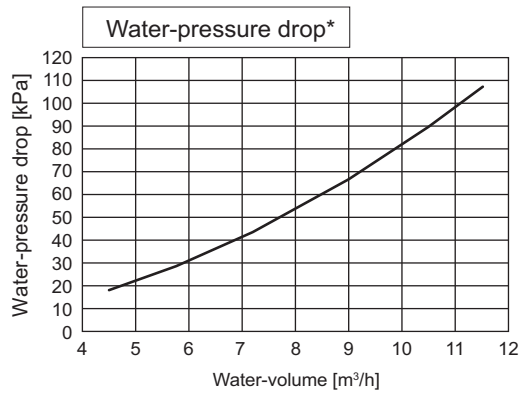
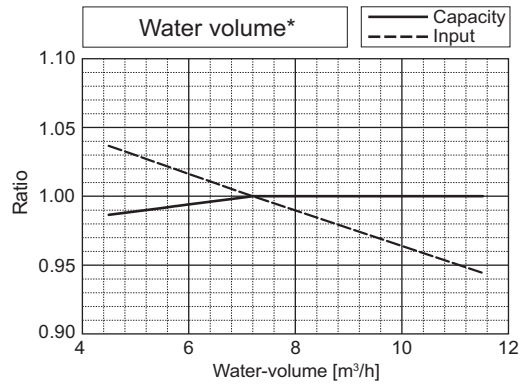

7. CAPACITY TABLES

PQRY-P-T(S)LMU-A1, Y(S)LMU-A1

PQRY-		P312TSLMU/YSLMU
Nominal Cooling Capacity	kW	91.4
	BTU/h	312,000
Input	kW	23.41

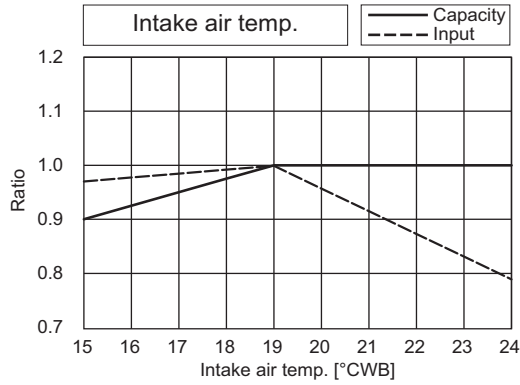
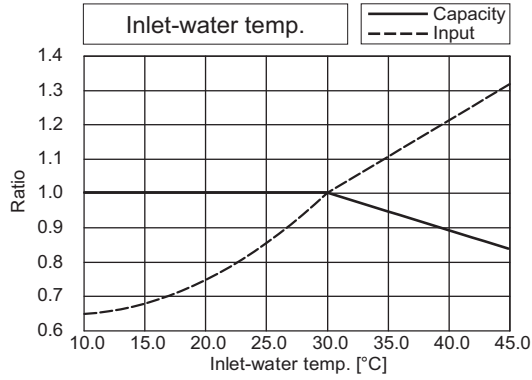

PQRY-		P312TSLMU/YSLMU
Nominal Heating Capacity	kW	102.6
	BTU/h	350,000
Input	kW	19.11

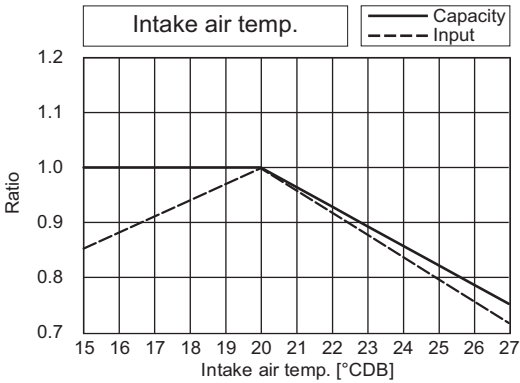
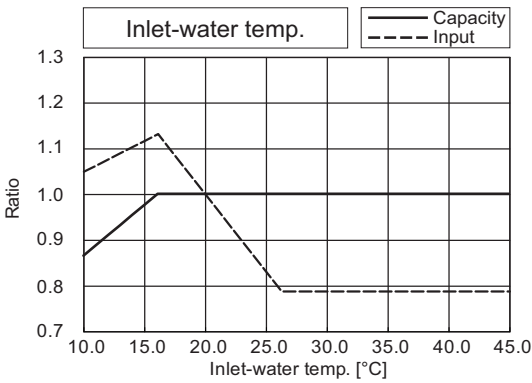

*The drawing indicates characteristic per unit.

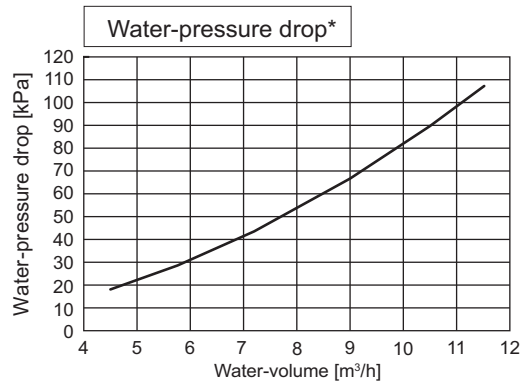
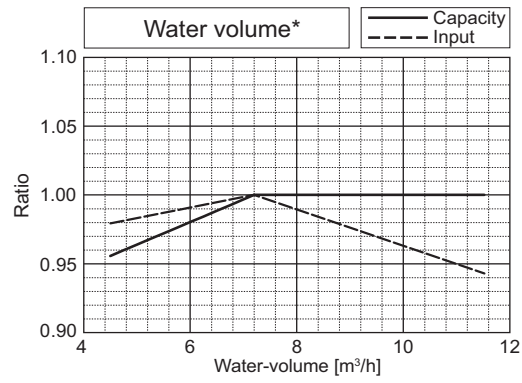
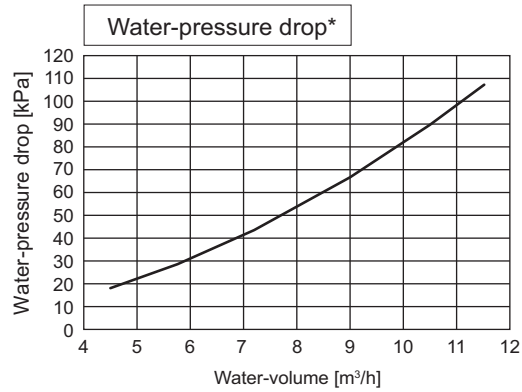
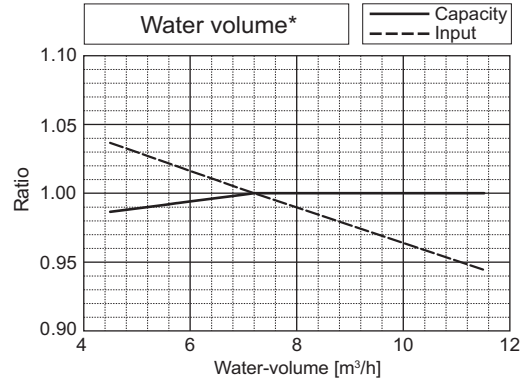

PQRY-		P336TSLMU/YSLMU
Nominal Cooling Capacity	kW	98.5
	BTU/h	336,000
Input	kW	26.84

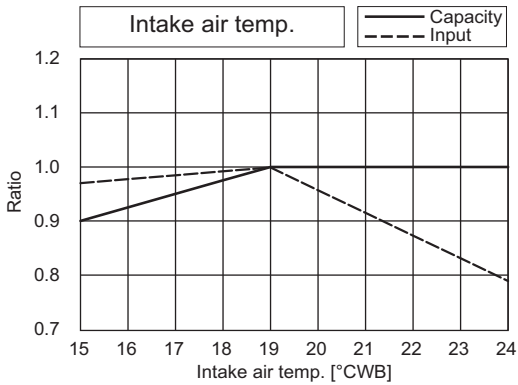
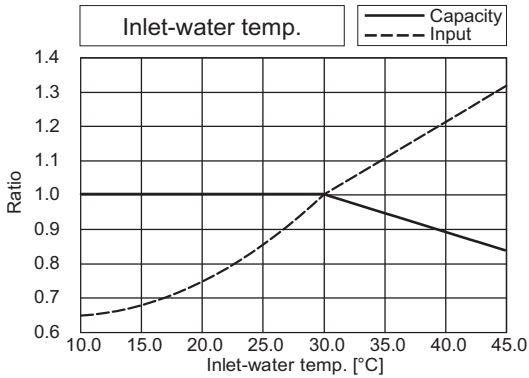

PQRY-		P336TSLMU/YSLMU
Nominal Heating Capacity	kW	110.8
	BTU/h	378,000
Input	kW	20.77

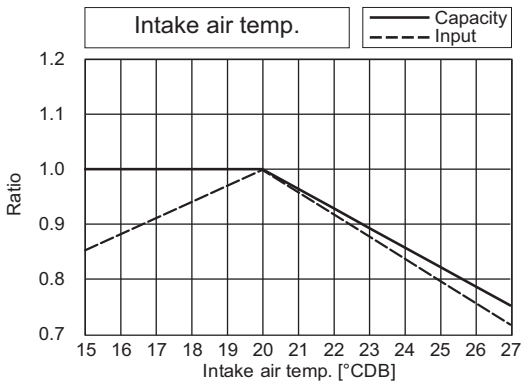
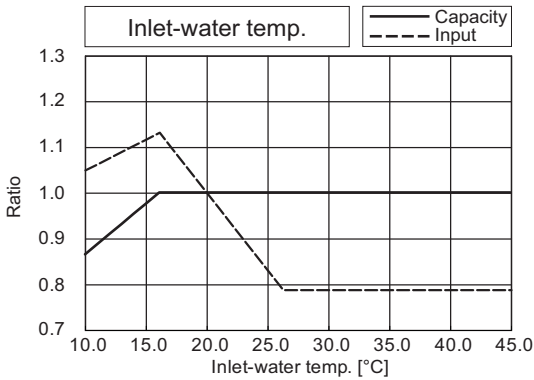

*The drawing indicates characteristic per unit.

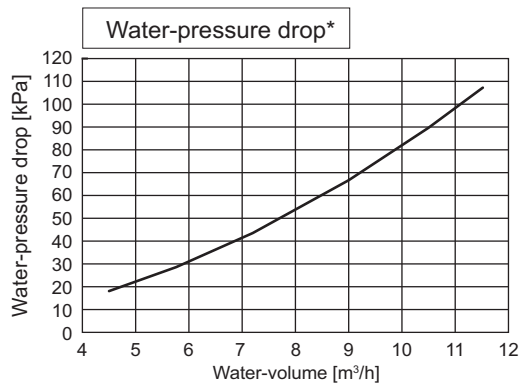
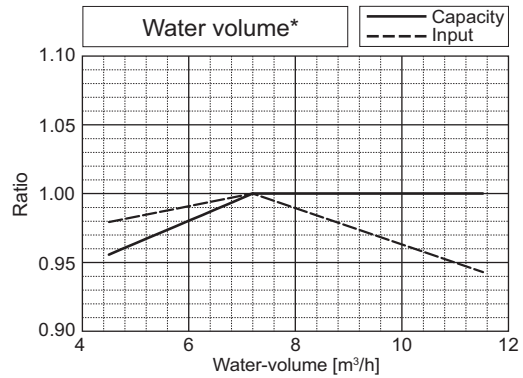
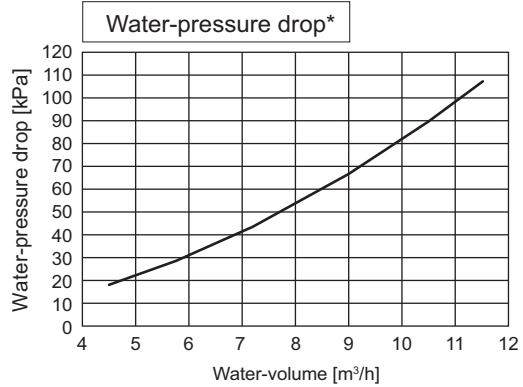
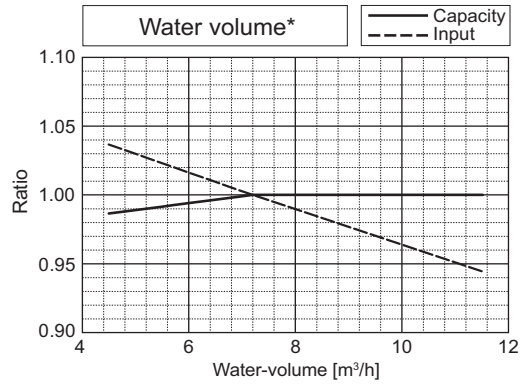

PQRY-P-T(S)LMU-A1, Y(S)LMU-A1

PQRY-		P72TLMU/YLMU
Nominal Cooling Capacity	kW	21.1
	BTU/h	72,000
Input	kW	3.61

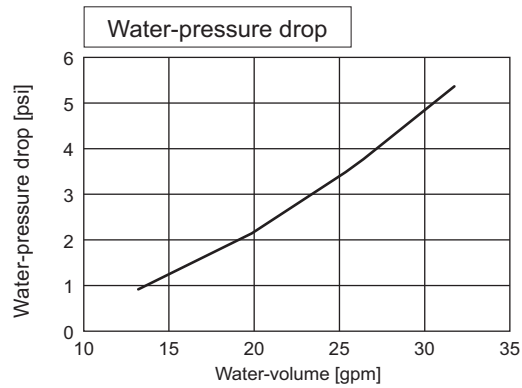
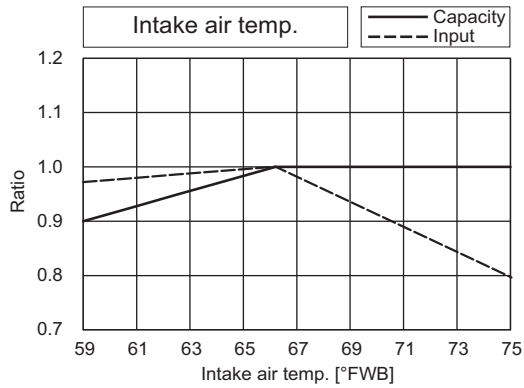
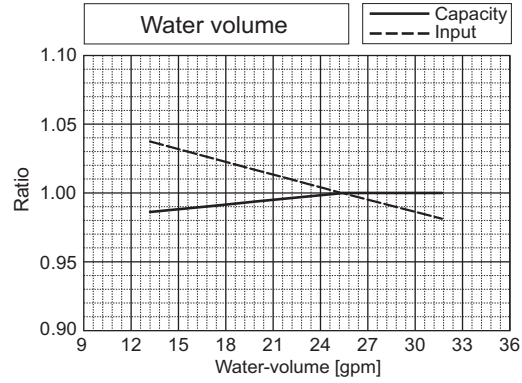
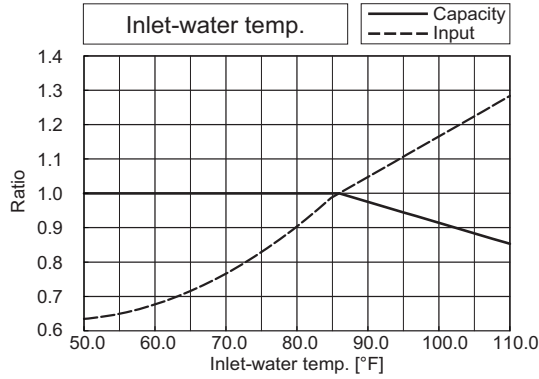

PQRY-		P72TLMU/YLMU
Nominal Heating Capacity	kW	23.4
	BTU/h	80,000
Input	kW	4.04

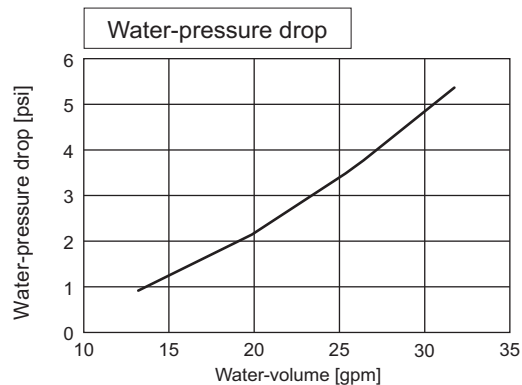
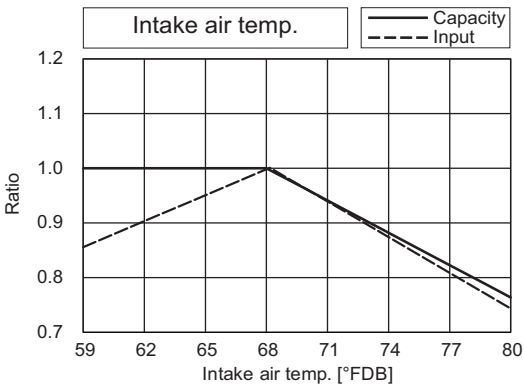
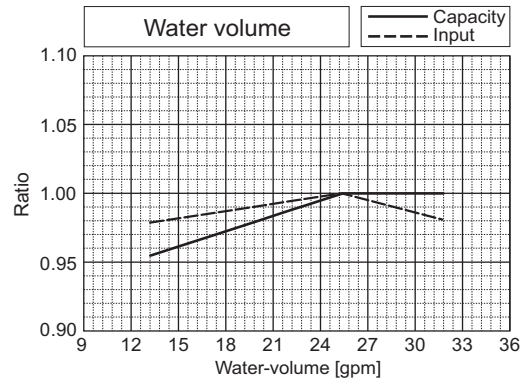
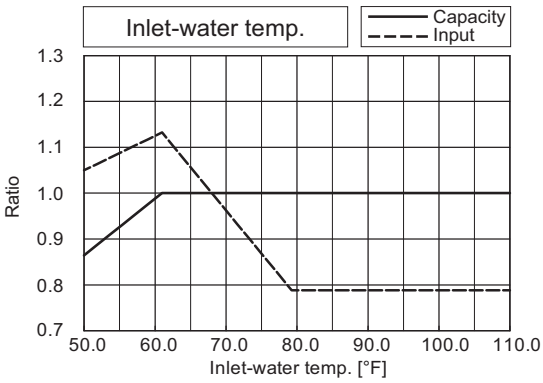

PQRY-		P96TLMU/YLMU
Nominal Cooling Capacity	kW	28.1
	BTU/h	96,000
Input	kW	5.21

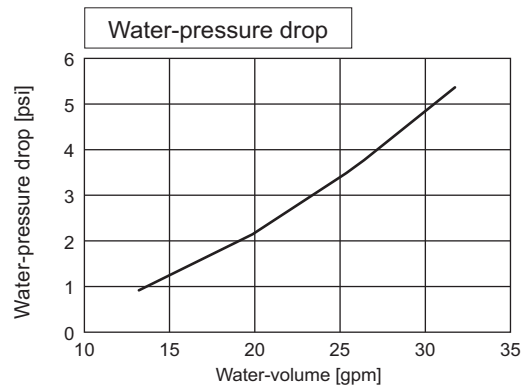
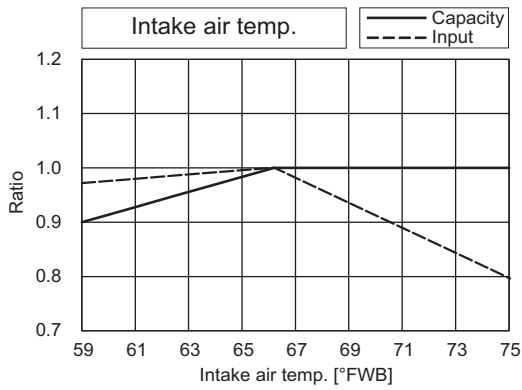
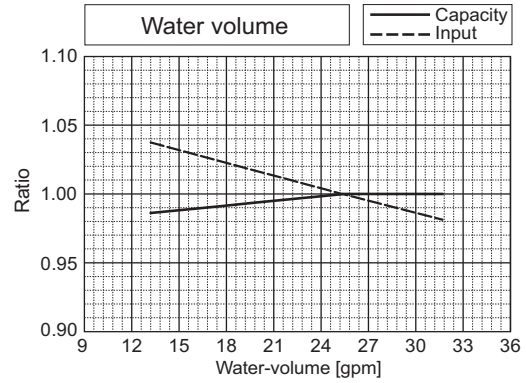
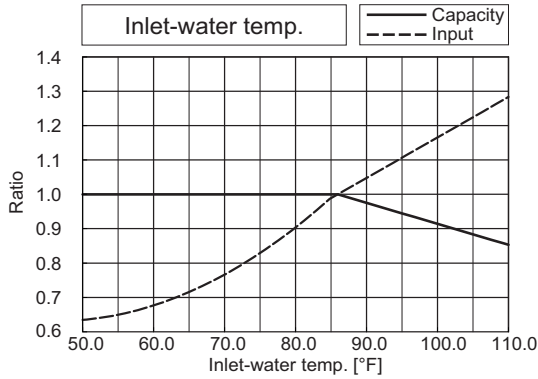

PQRY-		P96TLMU/YLMU
Nominal Heating Capacity	kW	31.7
	BTU/h	108,000
Input	kW	5.64

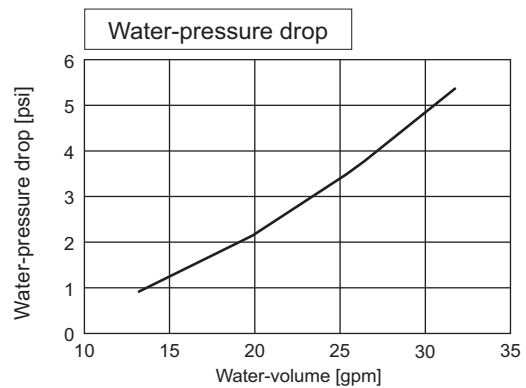
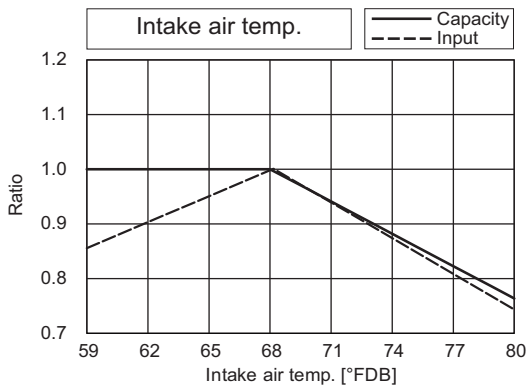
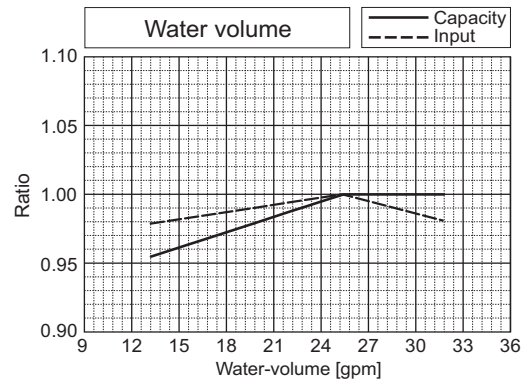
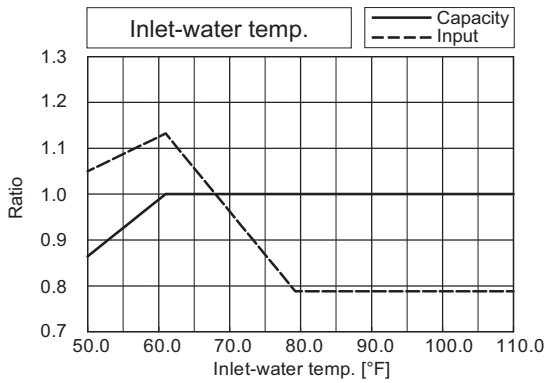

PQRY-P-T(S)LMU-A1, Y(S)LMU-A1

PQRY-P-T(S)LMU-A1, Y(S)LMU-A1

PQRY-		P120TLMU/YLMU
Nominal Cooling Capacity	kW	35.2
	BTU/h	120,000
Input	kW	7.51

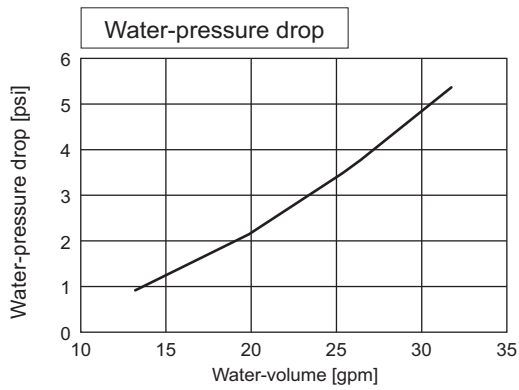
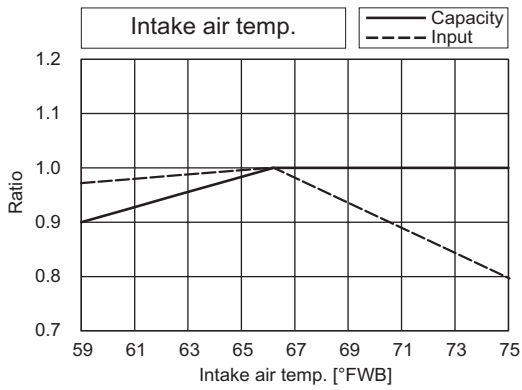
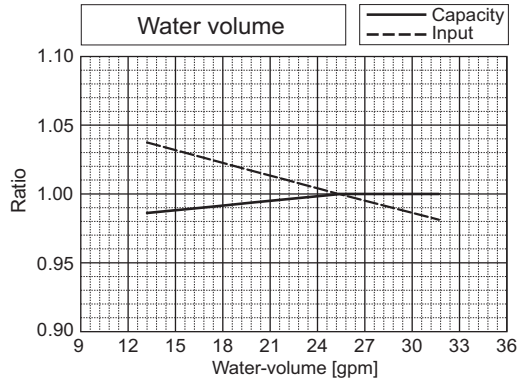
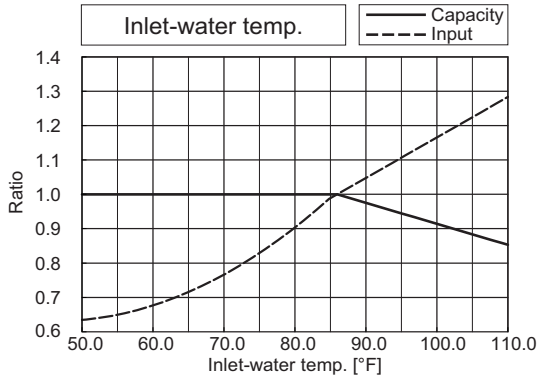

PQRY-		P120TLMU/YLMU
Nominal Heating Capacity	kW	39.6
	BTU/h	135,000
Input	kW	7.09

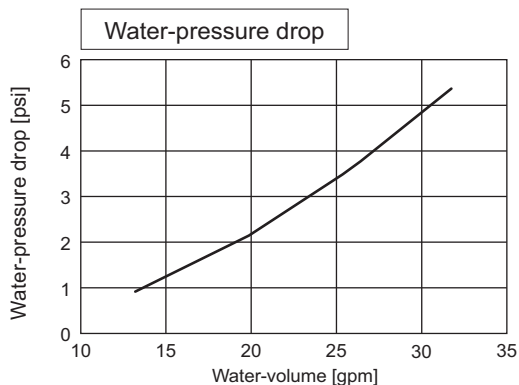
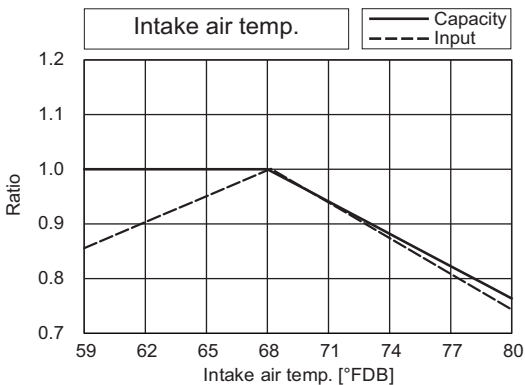
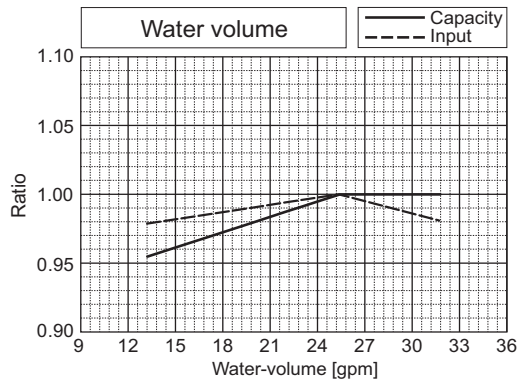
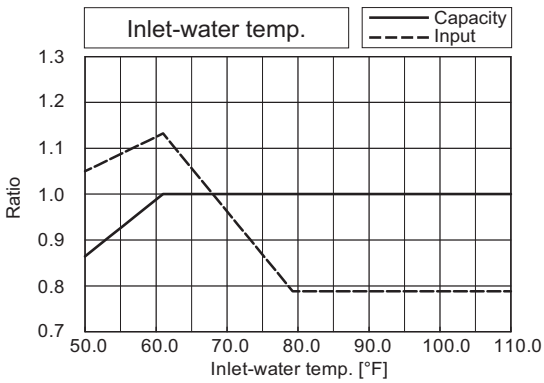

PQRY-		P144TLMU/YLMU
Nominal Cooling Capacity	kW	42.2
	BTU/h	144,000
Input	kW	8.78

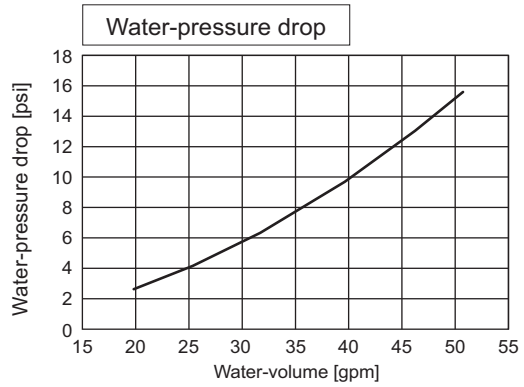
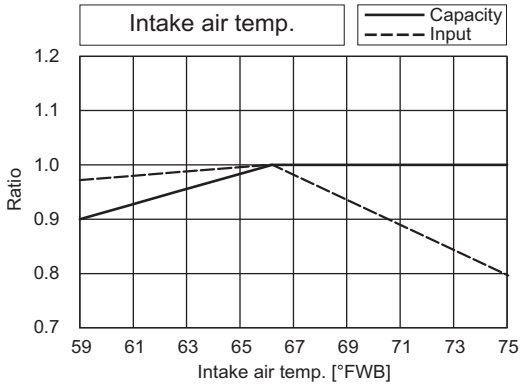
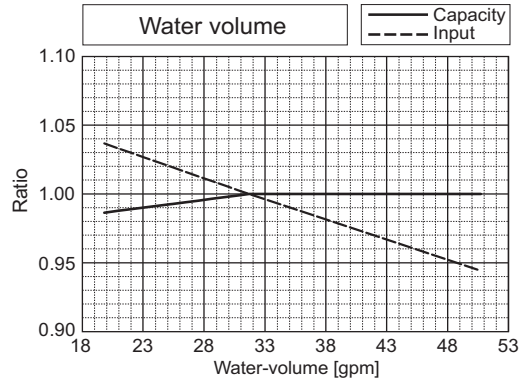
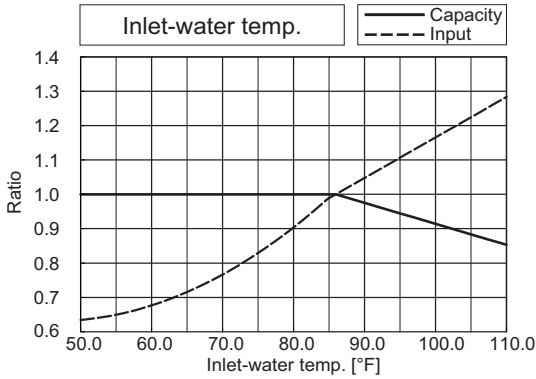

PQRY-		P144TLMU/YLMU
Nominal Heating Capacity	kW	46.9
	BTU/h	160,000
Input	kW	8.11

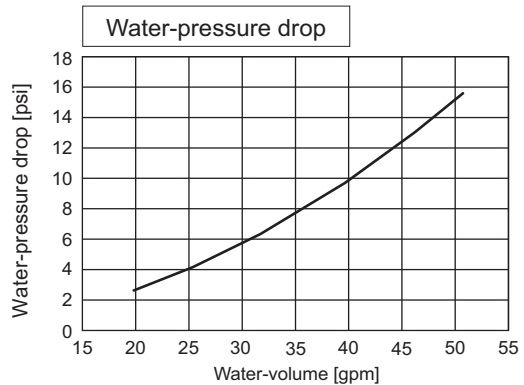
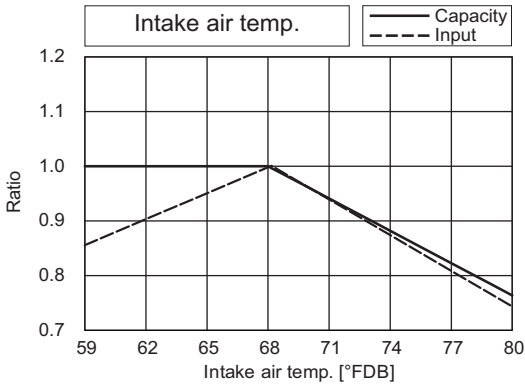
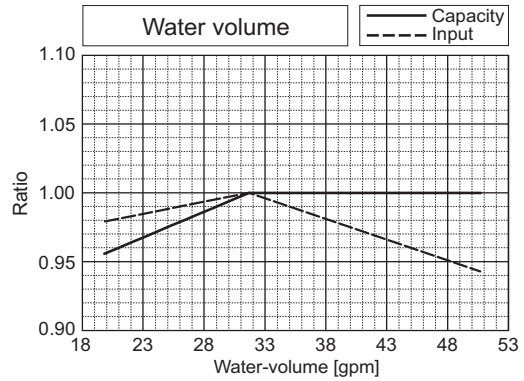
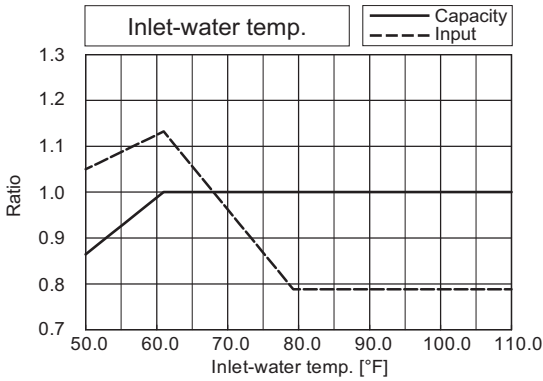

7. CAPACITY TABLES

PQRY-P-T(S)LMU-A1, Y(S)LMU-A1

PQRY-		P168TLMU/YLMU
Nominal Cooling Capacity	kW	49.2
	BTU/h	168,000
Input	kW	12.05

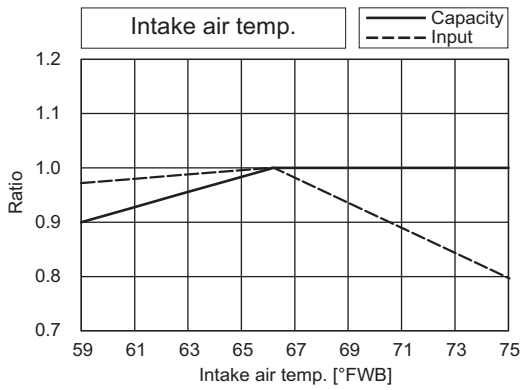
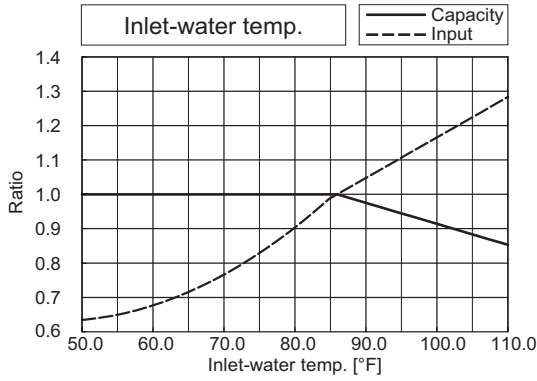

PQRY-		P168TLMU/YLMU
Nominal Heating Capacity	kW	55.1
	BTU/h	188,000
Input	kW	9.86

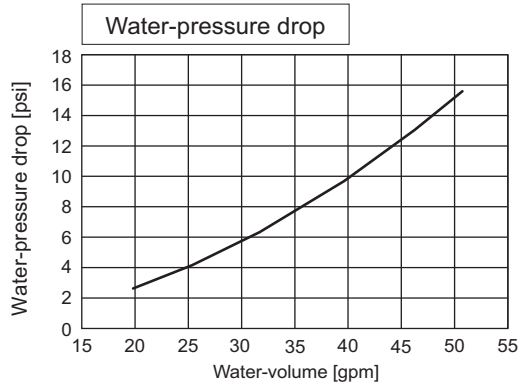
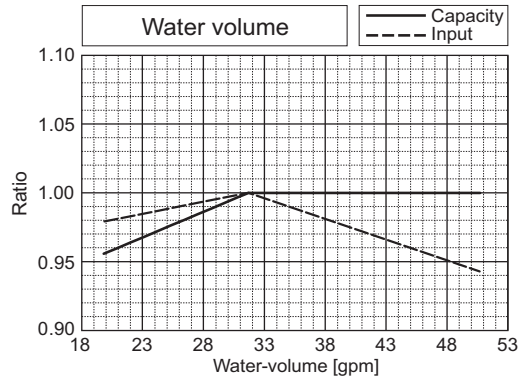
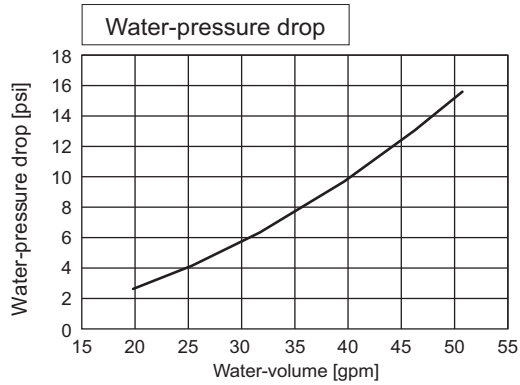
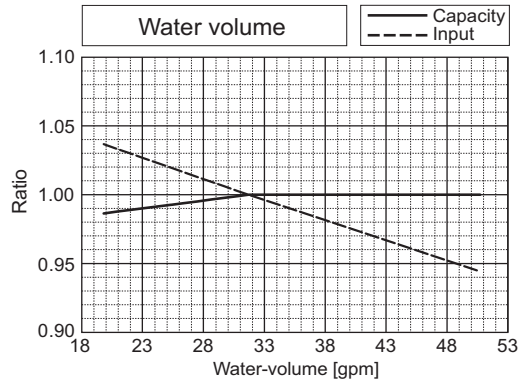
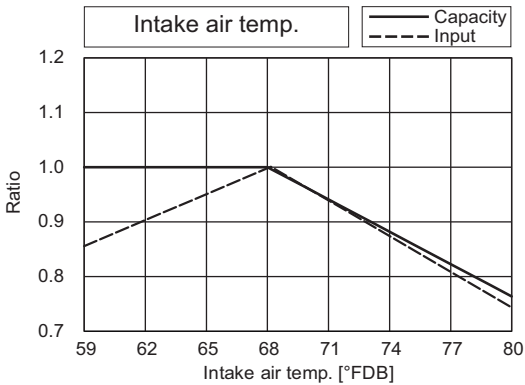
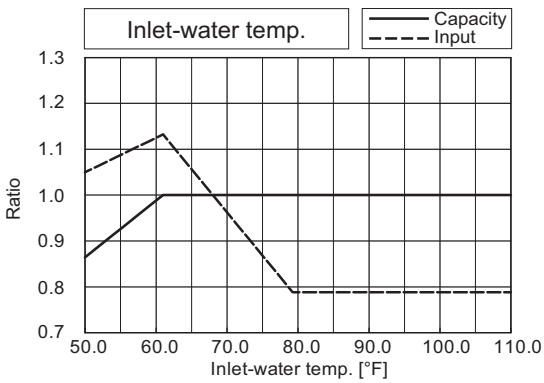

PQRY-		P192TLMU/YLMU
Nominal Cooling Capacity	kW	56.3
	BTU/h	192,000
Input	kW	15.05

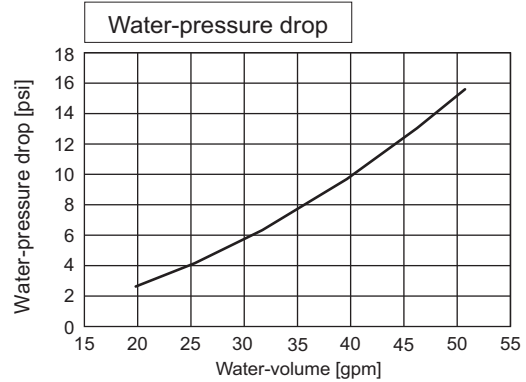
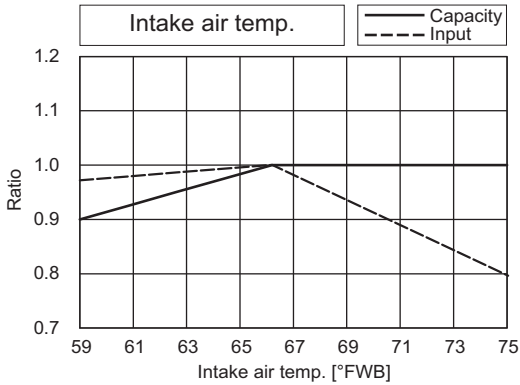
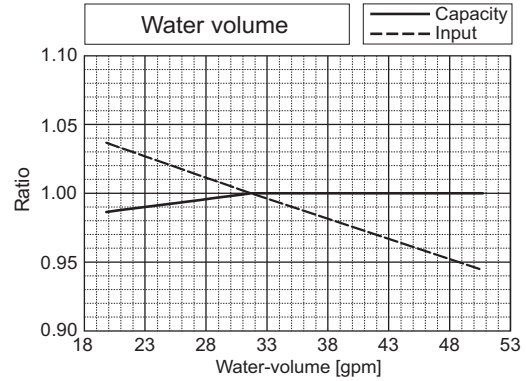
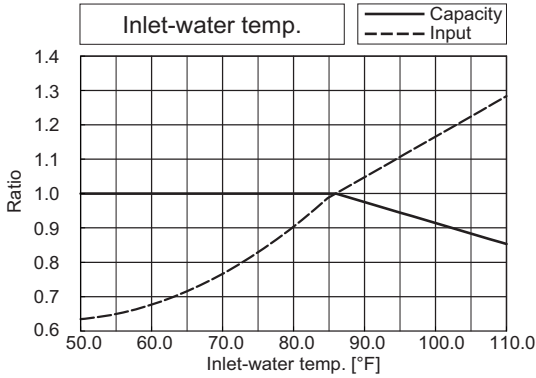

PQRY-		P192TLMU/YLMU
Nominal Heating Capacity	kW	63.0
	BTU/h	215,000
Input	kW	11.90

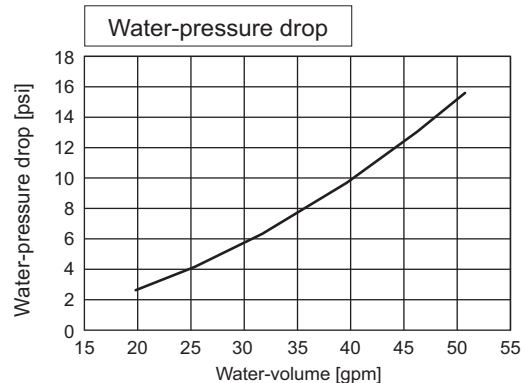
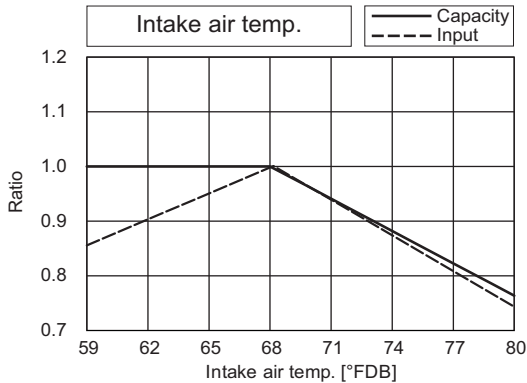
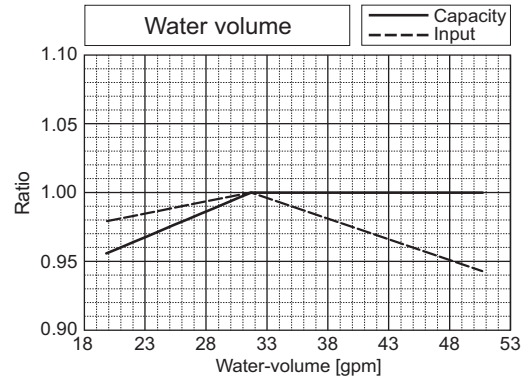
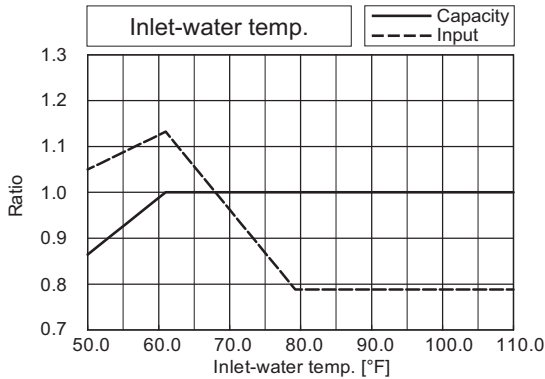

7. CAPACITY TABLES

PQRY-P-T(S)LMU-A1, Y(S)LMU-A1

PQRY-		P216TLMU/YLMU
Nominal Cooling Capacity	kW	63.3
	BTU/h	216,000
Input	kW	19.23

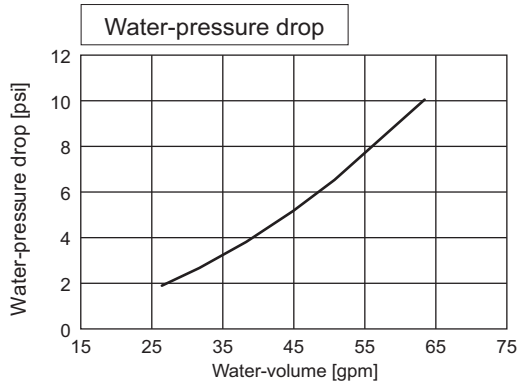
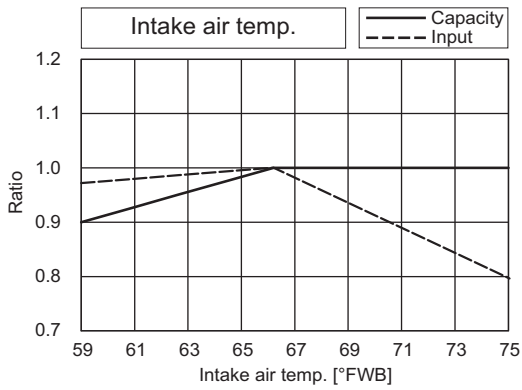
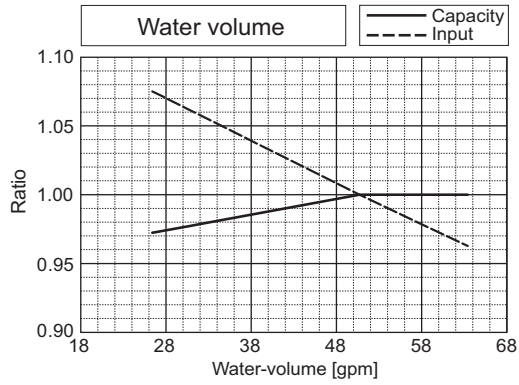
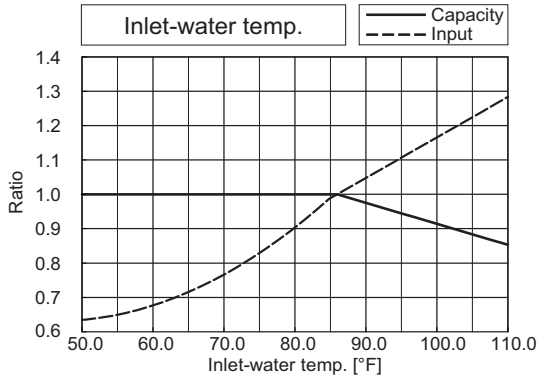

PQRY-		P216TLMU/YLMU
Nominal Heating Capacity	kW	71.2
	BTU/h	243,000
Input	kW	13.04

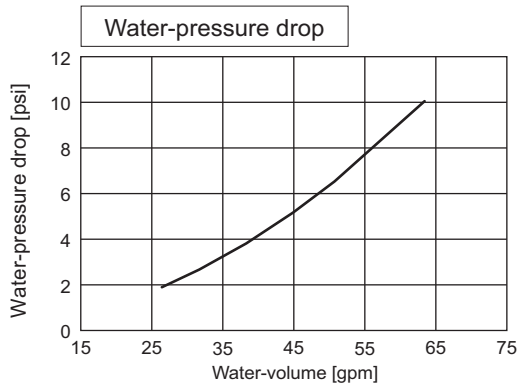
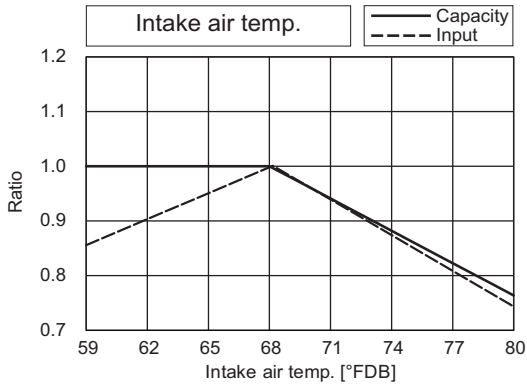
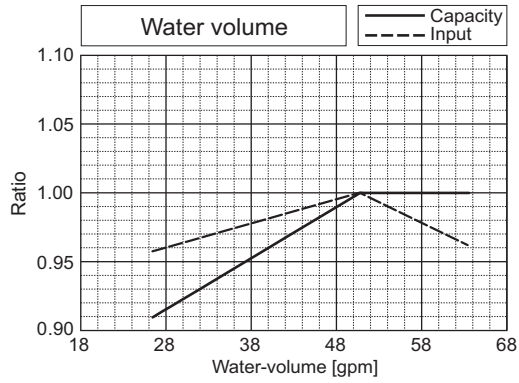
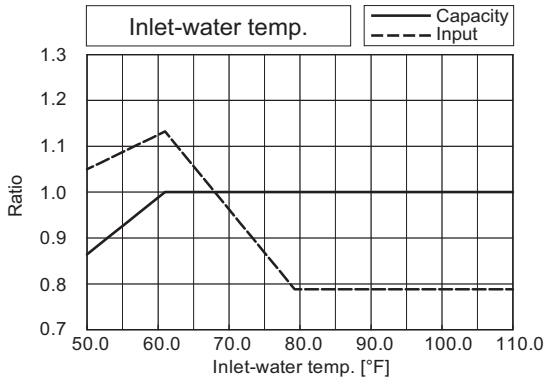

PQRY-		P240TLMU/YLMU
Nominal Cooling Capacity	kW	65.7
	BTU/h	224,000
Input	kW	21.14

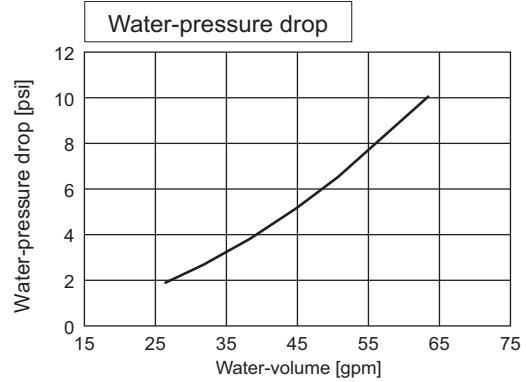
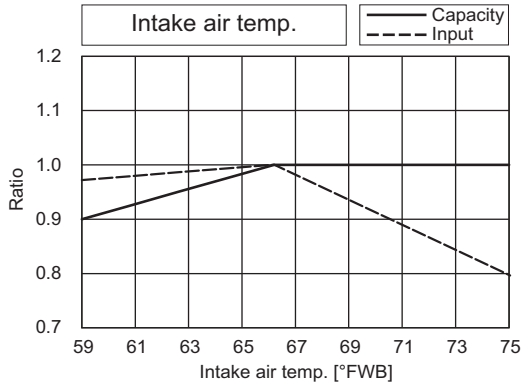
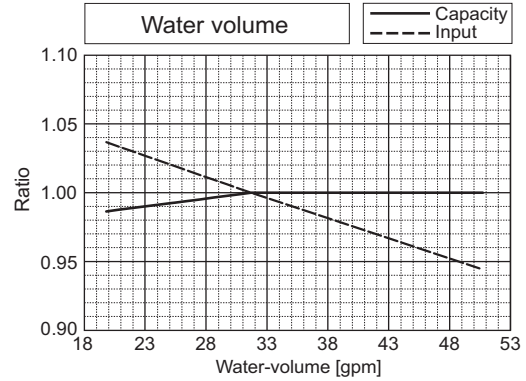
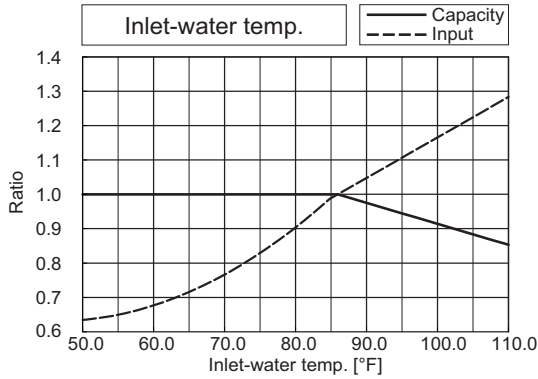

PQRY-		P240TLMU/YLMU
Nominal Heating Capacity	kW	79.1
	BTU/h	270,000
Input	kW	15.12

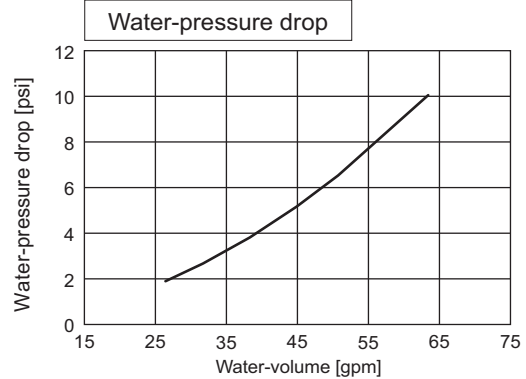
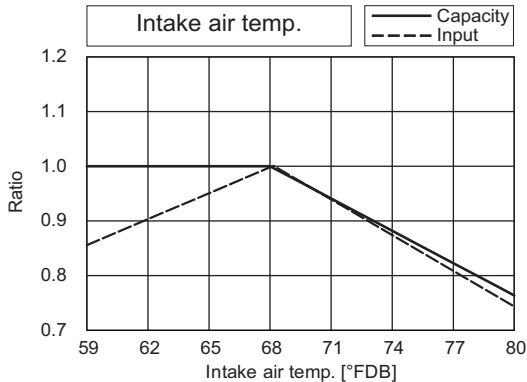
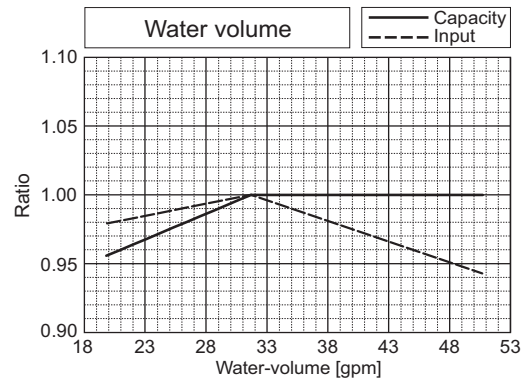
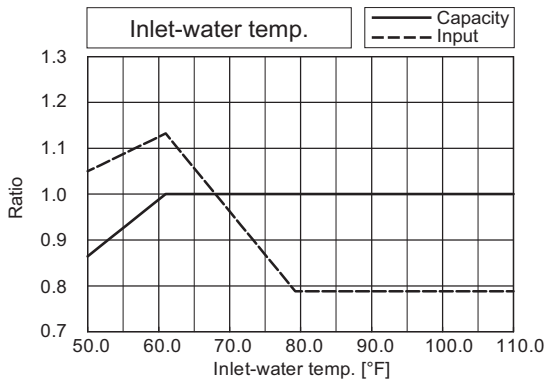

7. CAPACITY TABLES

PQRY-P-T(S)LMU-A1, Y(S)LMU-A1

PQRY-		P144TSLMU/YSLMU
Nominal Cooling Capacity	kW	42.2
	BTU/h	144,000
Input	kW	7.11

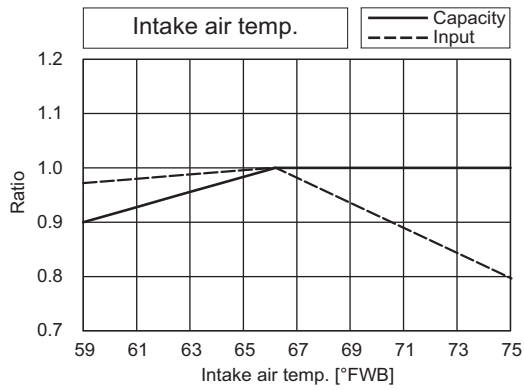
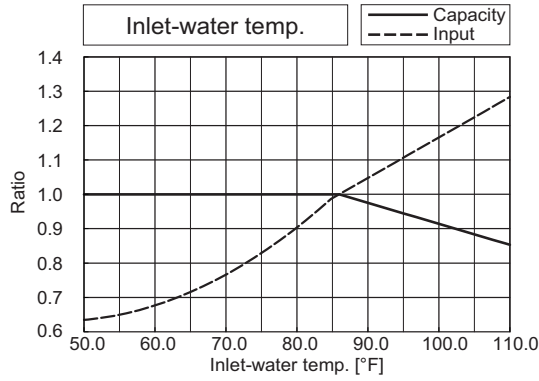

PQRY-		P144TSLMU/YSLMU
Nominal Heating Capacity	kW	46.9
	BTU/h	160,000
Input	kW	7.45

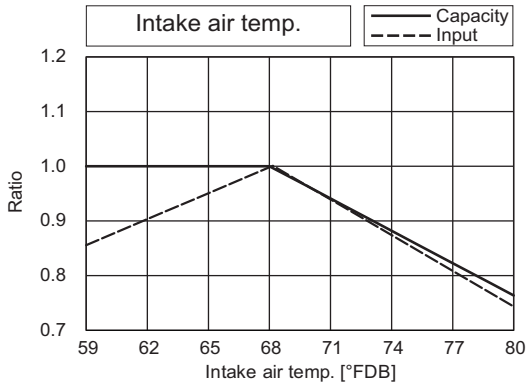
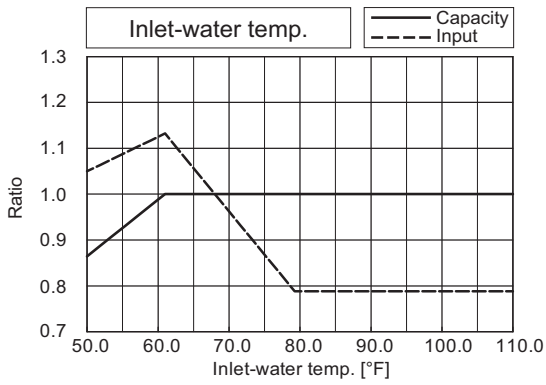

*The drawing indicates characteristic per unit.

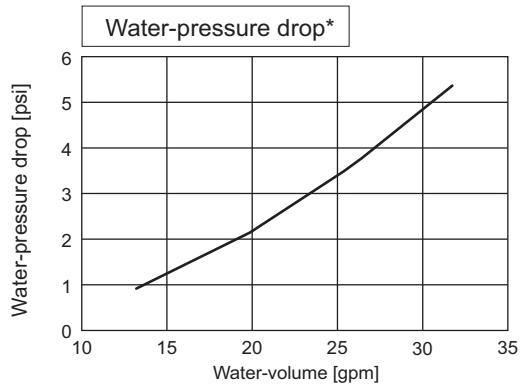
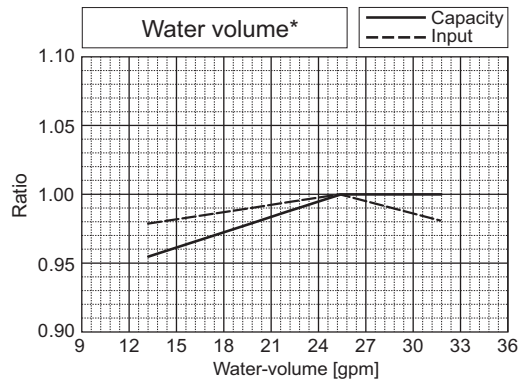
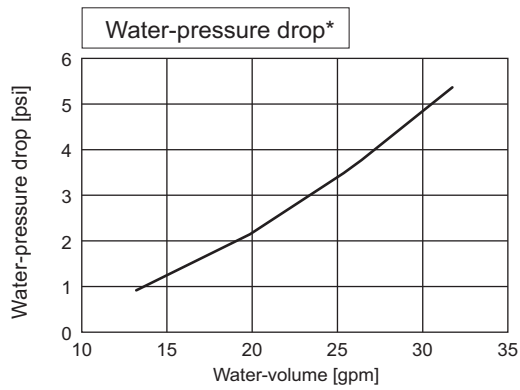
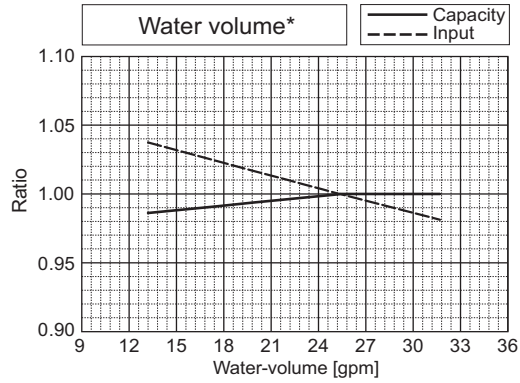

PQRY-		P168TSLMU/YSLMU
Nominal Cooling Capacity	kW	49.2
	BTU/h	168,000
Input	kW	9.33

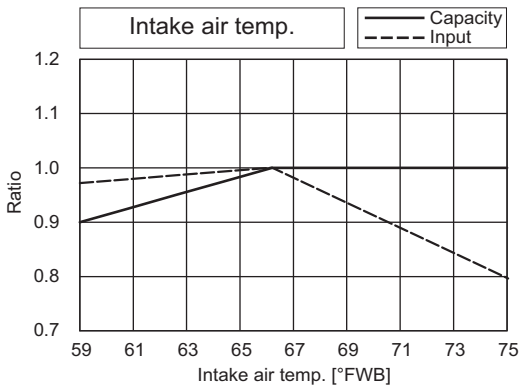
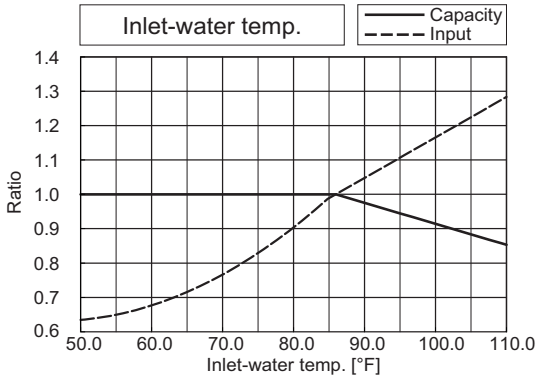

PQRY-		P168TSLMU/YSLMU
Nominal Heating Capacity	kW	55.1
	BTU/h	188,000
Input	kW	9.34

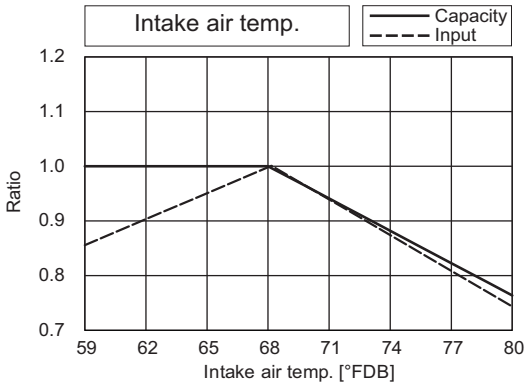
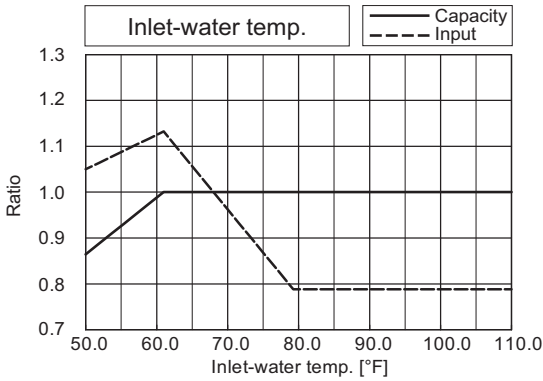

*The drawing indicates characteristic per unit.

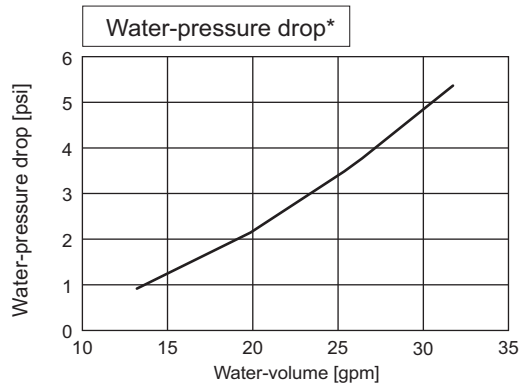
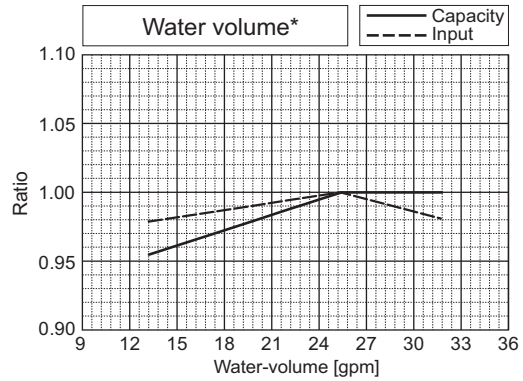
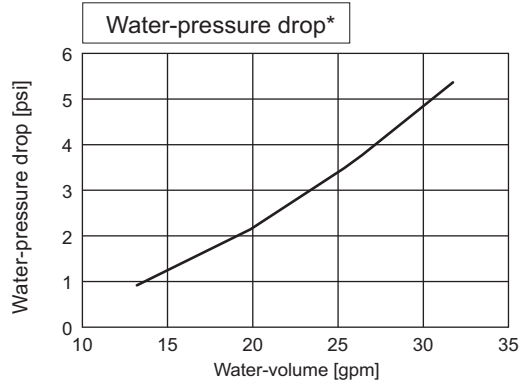
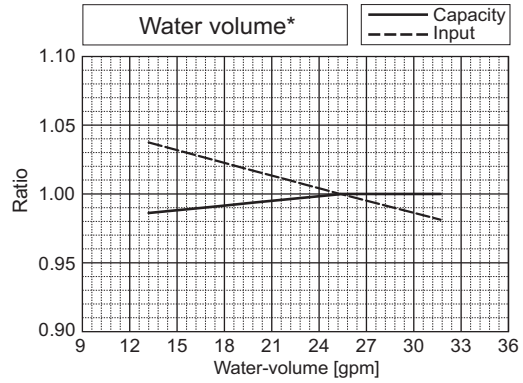

PQRY-P-T(S)LMU-A1, Y(S)LMU-A1

7. CAPACITY TABLES

PQRY-P-T(S)LMU-A1, Y(S)LMU-A1

*The drawing indicates characteristic per unit.

PQRY-		P192TSLMU/YSLMU
Nominal Cooling Capacity	kW	56.3
	BTU/h	192,000
Input	kW	11.30

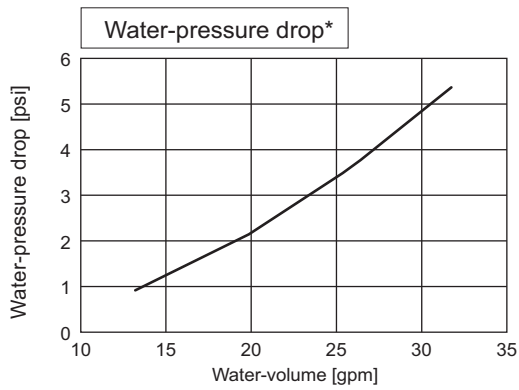
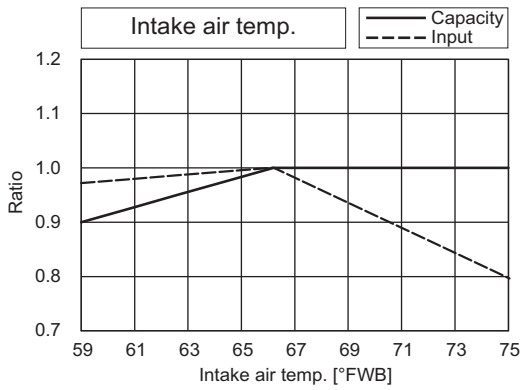
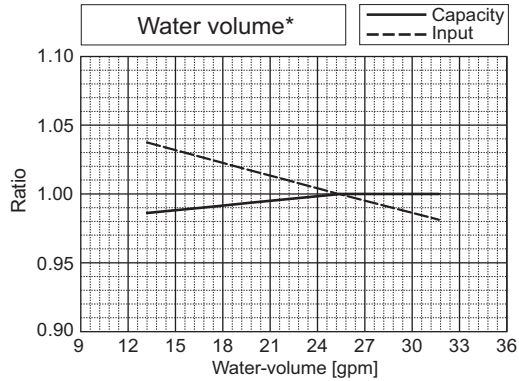
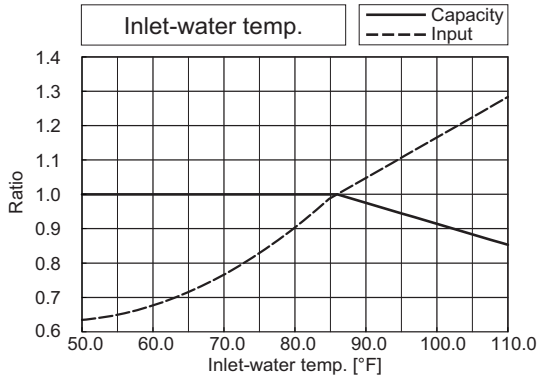

PQRY-		P192TSLMU/YSLMU
Nominal Heating Capacity	kW	63.0
	BTU/h	215,000
Input	kW	11.02

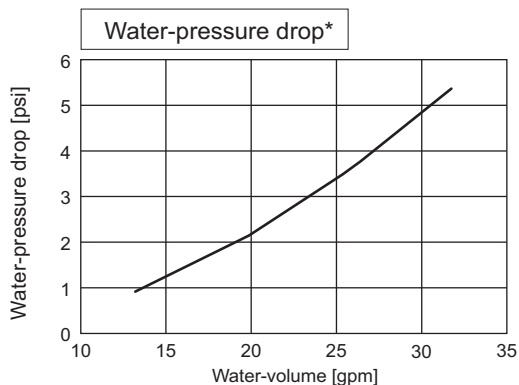
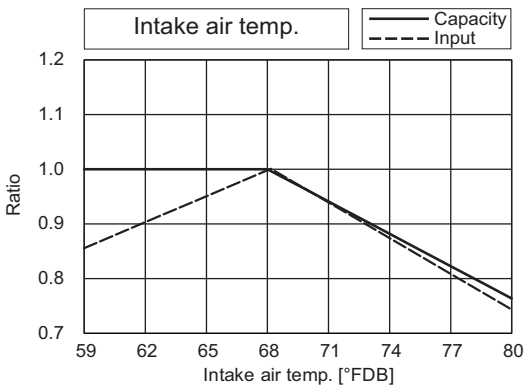
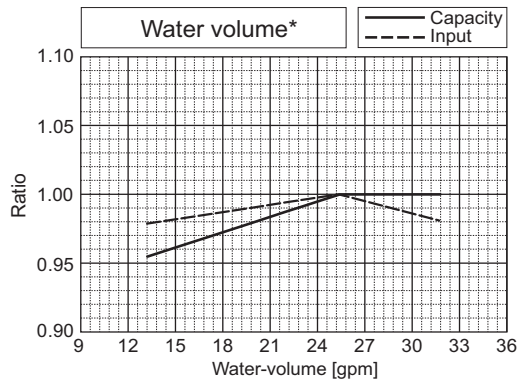
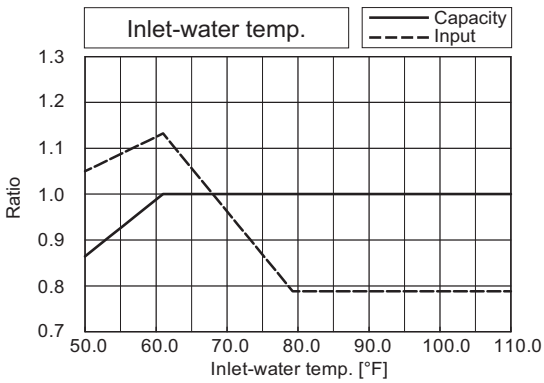

PQRY-		P216TSLMU/YSLMU
Nominal Cooling Capacity	kW	63.3
	BTU/h	216,000
Input	kW	14.03

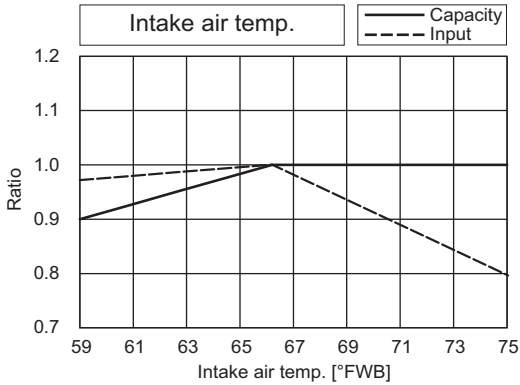
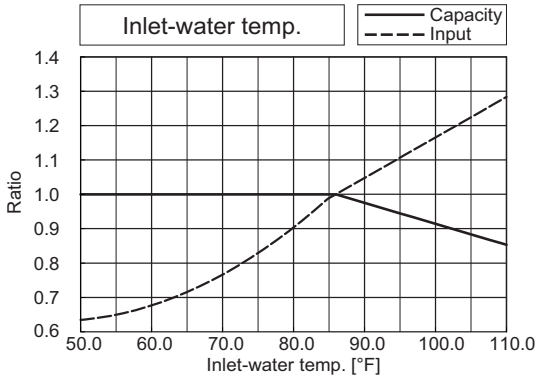

PQRY-		P216TSLMU/YSLMU
Nominal Heating Capacity	kW	71.2
	BTU/h	243,000
Input	kW	12.88

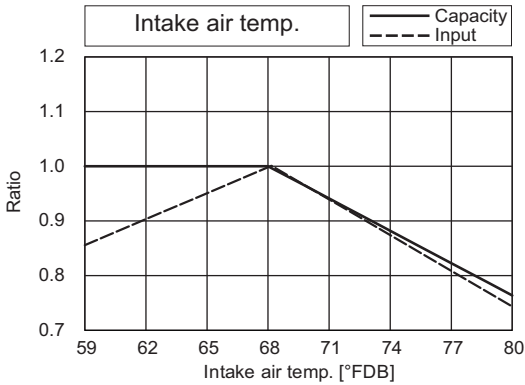
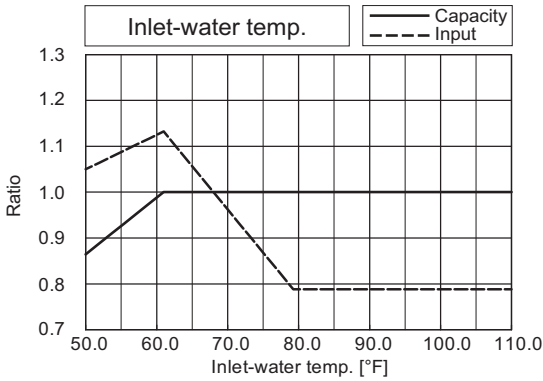

*The drawing indicates characteristic per unit.

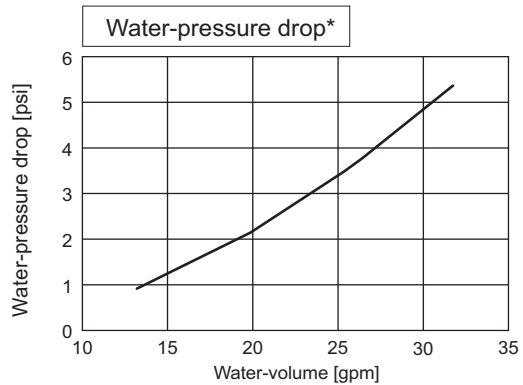
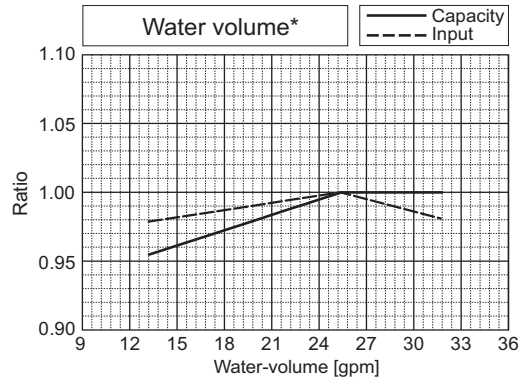
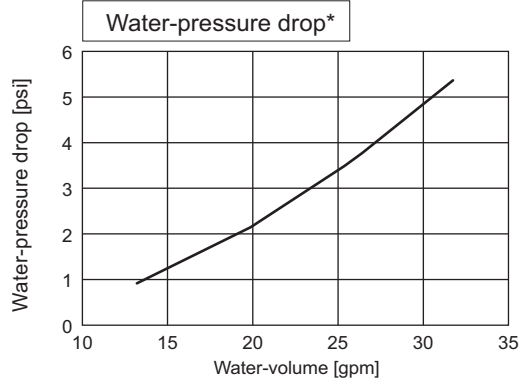
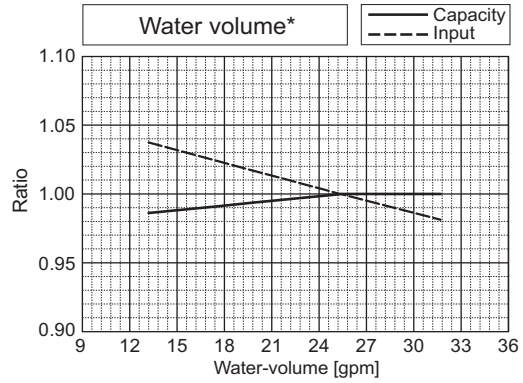

PQRY-P-T(S)LMU-A1, Y(S)LMU-A1

7. CAPACITY TABLES

PQRY-P-T(S)LMU-A1, Y(S)LMU-A1

PQRY-		P240TSLMU/YSLMU
Nominal Cooling Capacity	kW	70.3
	BTU/h	240,000
Input	kW	16.89

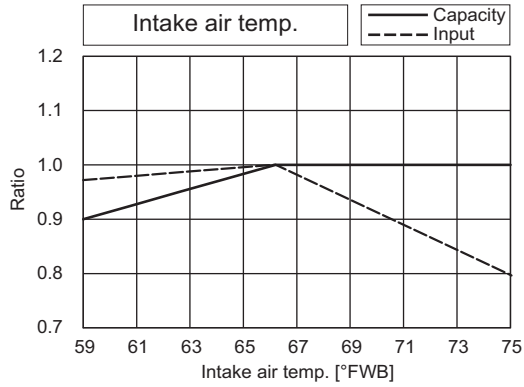
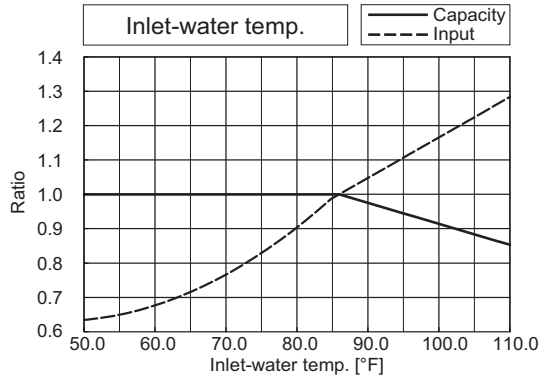

PQRY-		P240TSLMU/YSLMU
Nominal Heating Capacity	kW	79.1
	BTU/h	270,000
Input	kW	14.58

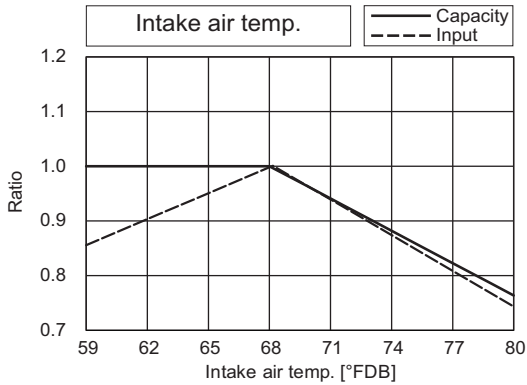
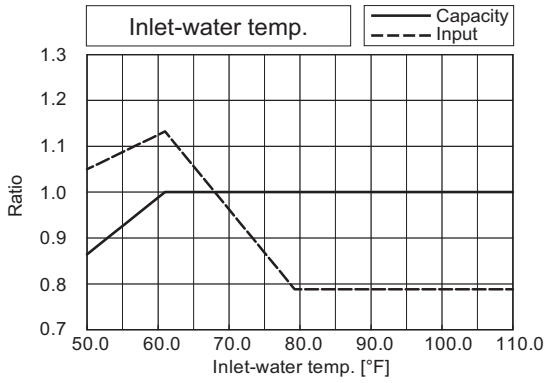

*The drawing indicates characteristic per unit.

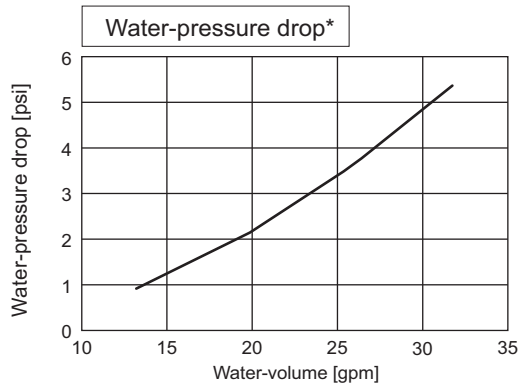
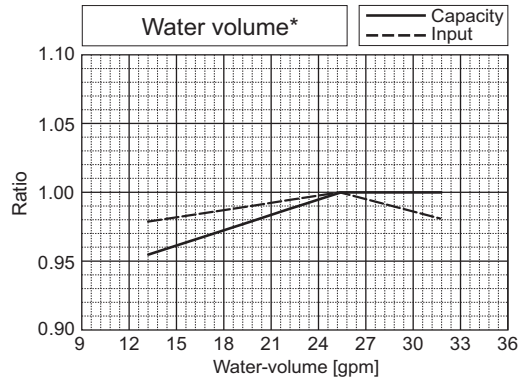
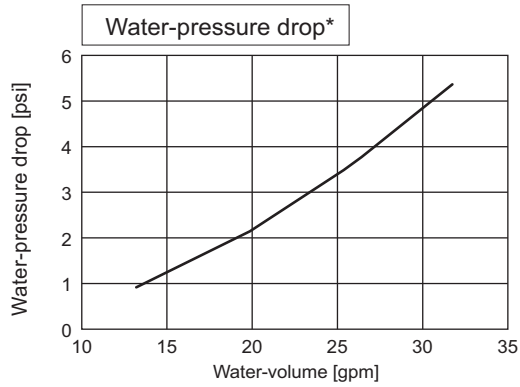
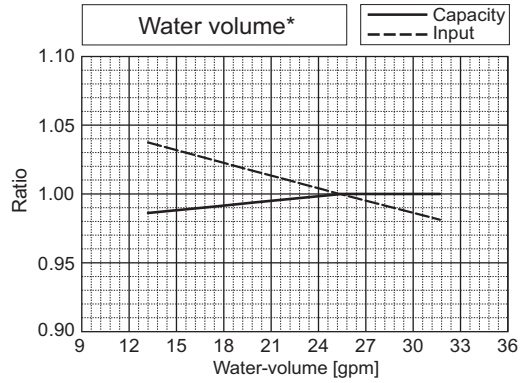

PQRY-		P288TSLMU/YSLMU
Nominal Cooling Capacity	kW	84.4
	BTU/h	288,000
Input	kW	20.42

*The drawing indicates characteristic per unit.

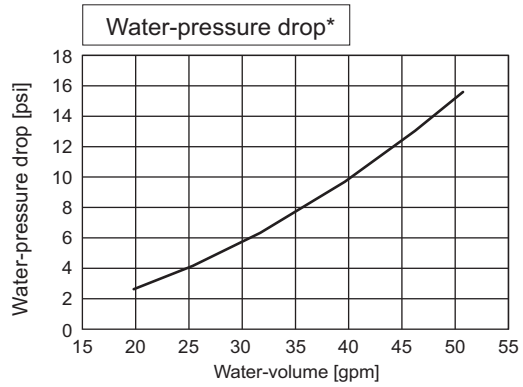
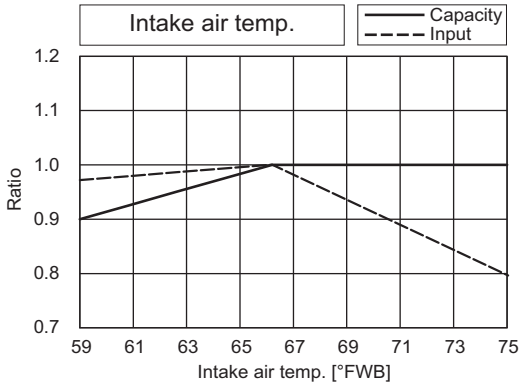
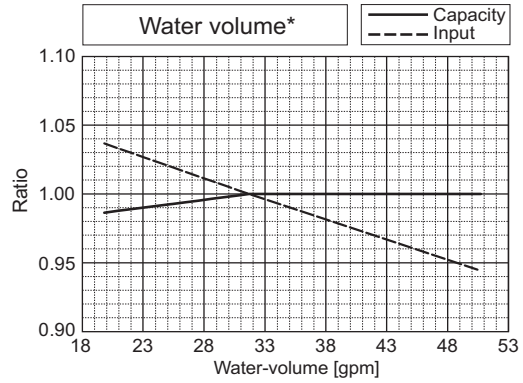
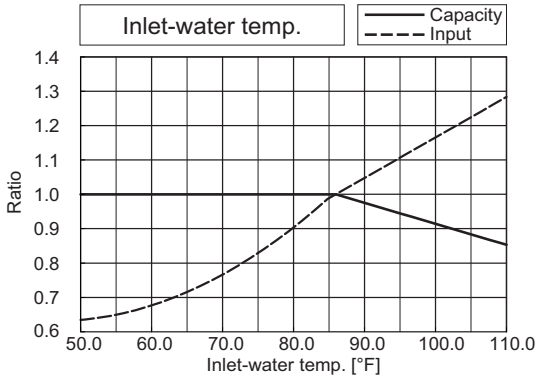

PQRY-		P288TSLMU/YSLMU
Nominal Heating Capacity	kW	94.7
	BTU/h	323,000
Input	kW	17.50

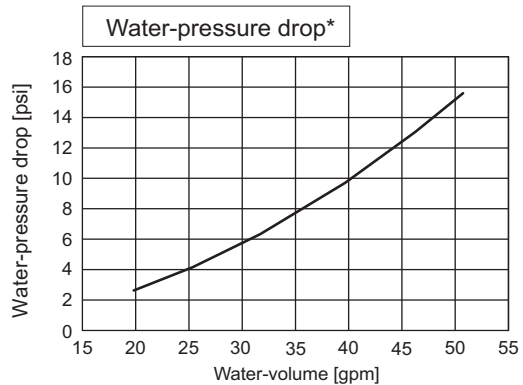
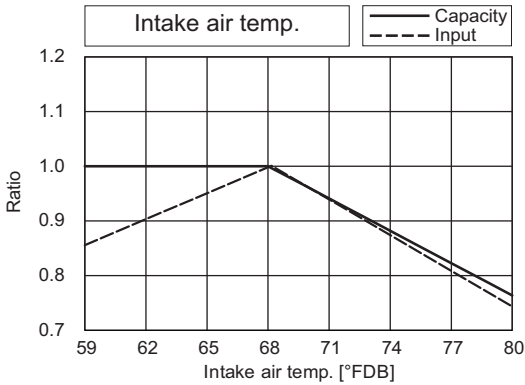
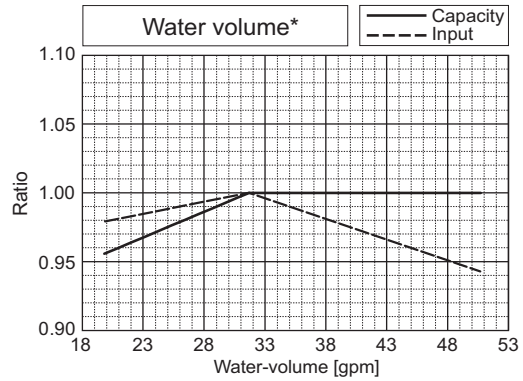
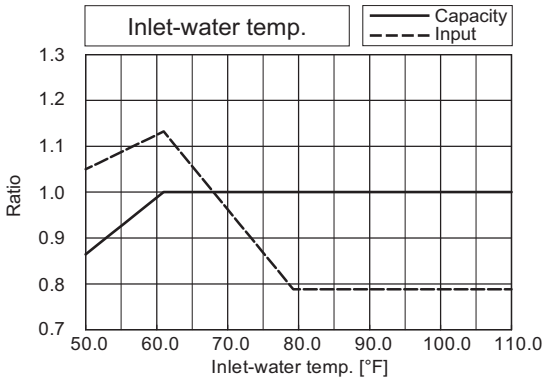

PQRY-P-T(S)LMU-A1, Y(S)LMU-A1

7. CAPACITY TABLES

PQRY-P-T(S)LMU-A1, Y(S)LMU-A1

PQRY-		P312TSLMU/YSLMU
Nominal Cooling Capacity	kW	91.4
	BTU/h	312,000
Input	kW	23.41

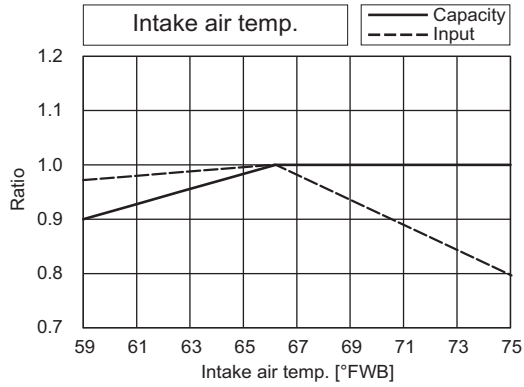
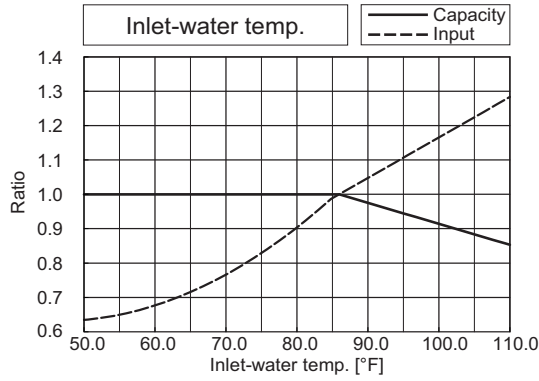

PQRY-		P312TSLMU/YSLMU
Nominal Heating Capacity	kW	102.6
	BTU/h	350,000
Input	kW	19.11

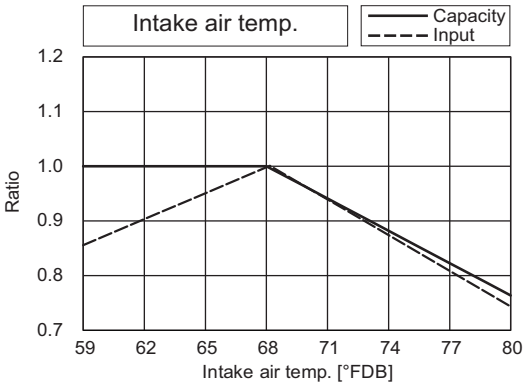
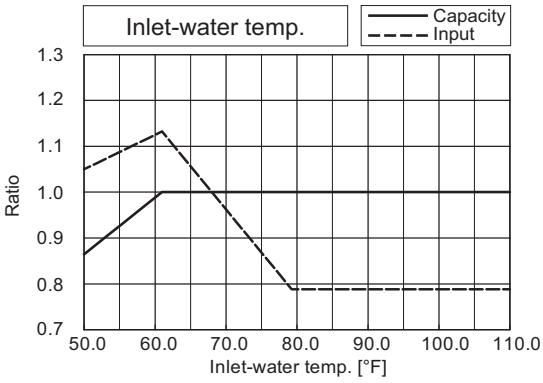

*The drawing indicates characteristic per unit.

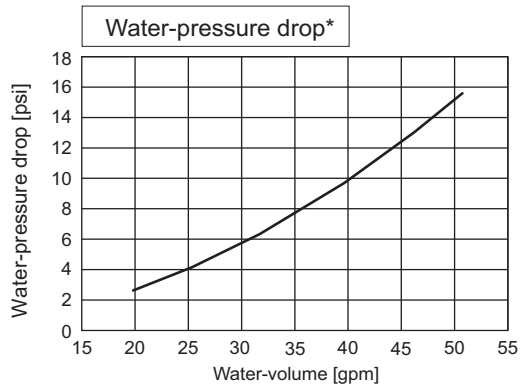
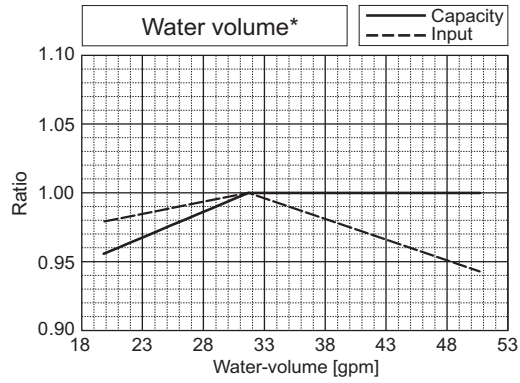
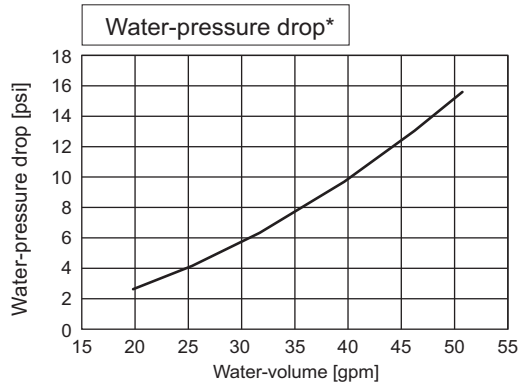
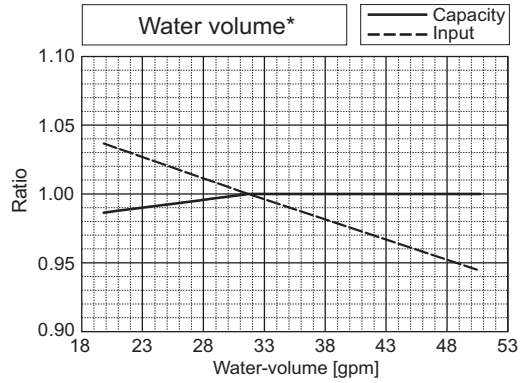

PQRY-		P336TSLMU/YSLMU
Nominal Cooling Capacity	kW	98.5
	BTU/h	336,000
Input	kW	26.84

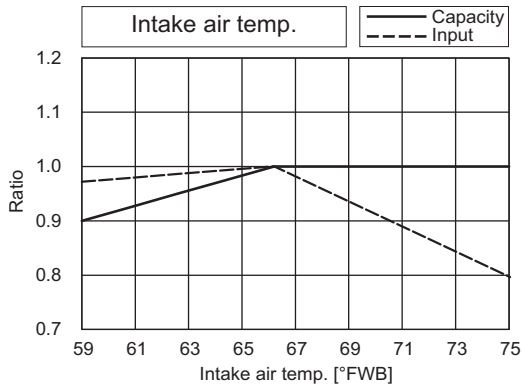
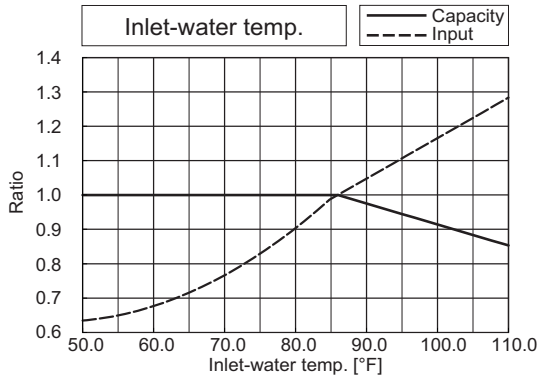

PQRY-		P336TSLMU/YSLMU
Nominal Heating Capacity	kW	110.8
	BTU/h	378,000
Input	kW	20.77

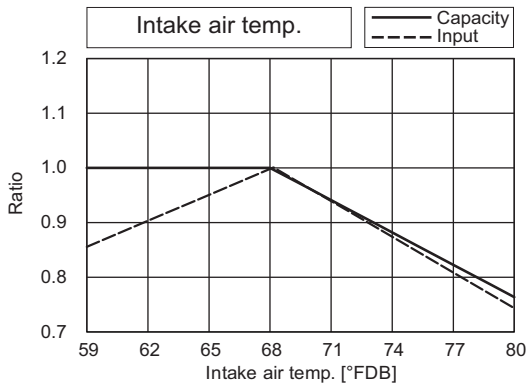
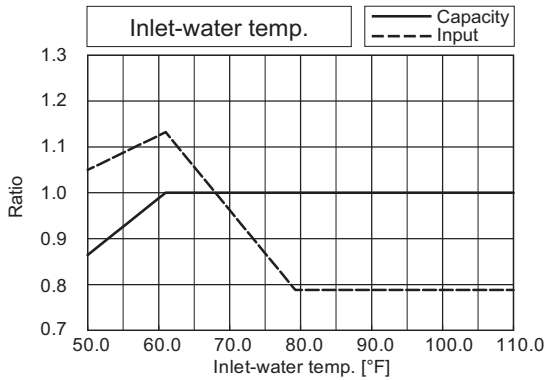

*The drawing indicates characteristic per unit.

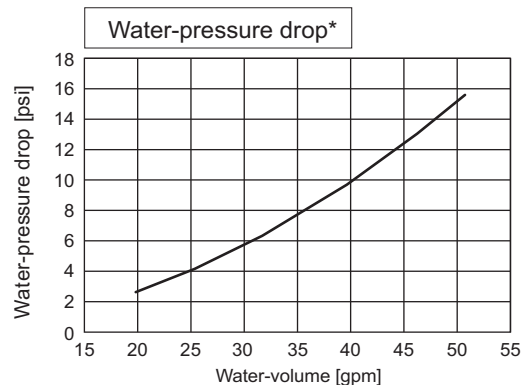
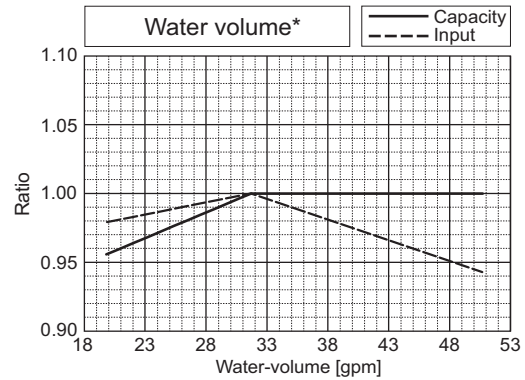
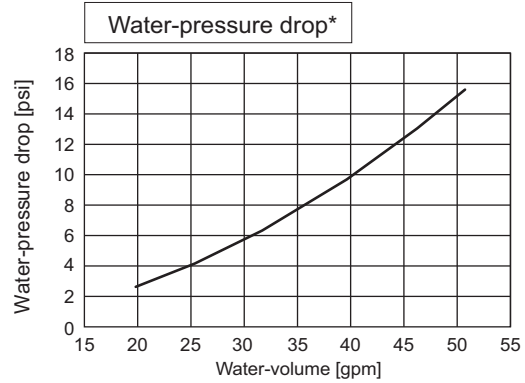
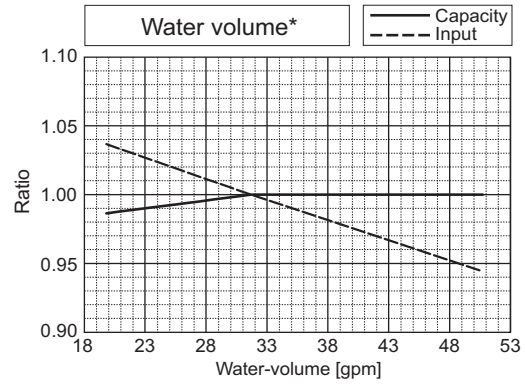

7-2. Correction by total indoor

CITY MULTI system have different capacities and inputs when many combinations of indoor units with different total capacities are connected. Using following tables, the maximum capacity can be found to ensure the system is installed with enough capacity for a particular application.

PQRY-P-T(S)LMU-A1, Y(S)LMU-A1

PQRY-		P72TLMU/YLMU	
Nominal cooling capacity	BTU/h	72,000	
	kW	21.1	
Input	kW	3.61	

PQRY-		P72TLMU/YLMU	
Nominal Heating capacity	BTU/h	80,000	
	kW	23.4	
Input	kW	4.04	

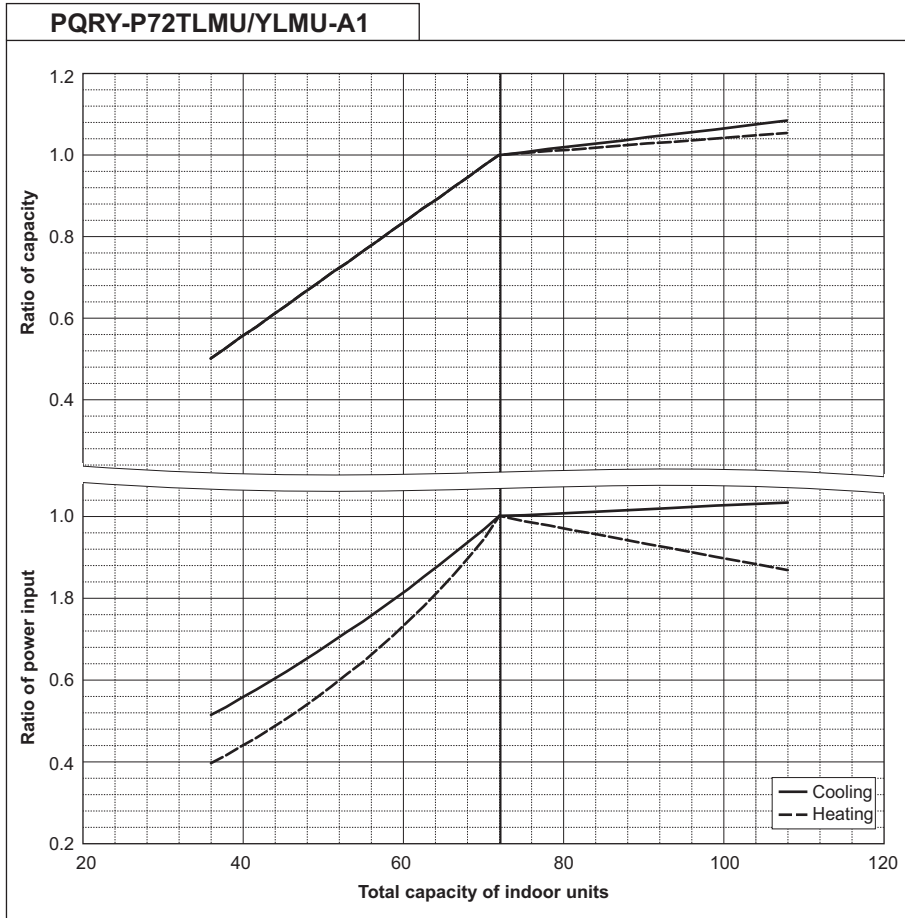

PQRY-		P96TLMU/YLMU	
Nominal cooling capacity	BTU/h	96,000	
	kW	28.1	
Input	kW	5.21	

PQRY-		P96TLMU/YLMU	
Nominal Heating capacity	BTU/h	108,000	
	kW	31.7	
Input	kW	5.64	

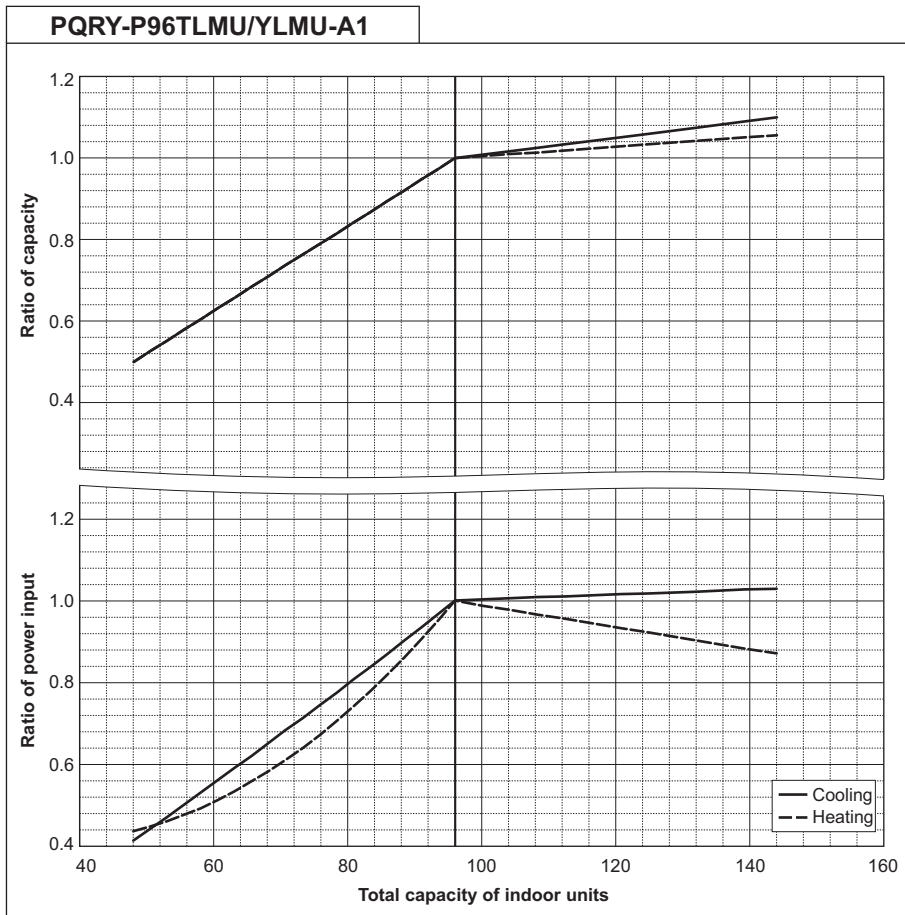

PQRY-		P120TLMU/YLMU	
Nominal cooling capacity	BTU/h	120,000	
	kW	35.2	
Input	kW	7.51	

PQRY-		P120TLMU/YLMU	
Nominal Heating capacity	BTU/h	135,000	
	kW	39.6	
Input	kW	7.09	

PQRY-P120TLMU/YLMU-A1

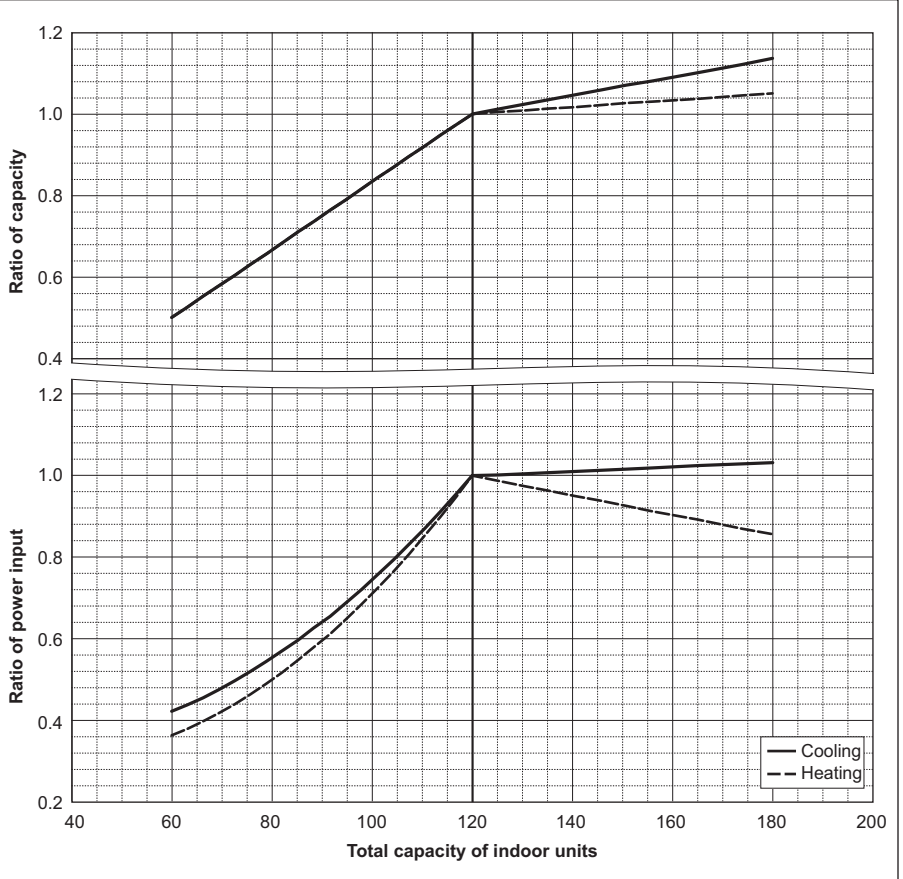

PQRY-		P144TLMU/YLMU	
Nominal cooling capacity	BTU/h	144,000	
	kW	42.2	
Input	kW	8.78	

PQRY-		P144TLMU/YLMU	
Nominal Heating capacity	BTU/h	160,000	
	kW	46.9	
Input	kW	8.11	

PQRY-		P144TSLMU/YSLMU	
Nominal cooling capacity	BTU/h	144,000	
	kW	42.2	
Input	kW	7.11	

PQRY-		P144TSLMU/YSLMU	
Nominal Heating capacity	BTU/h	160,000	
	kW	46.9	
Input	kW	7.45	

PQRY-P144T(S)LMU/Y(S)LMU-A1

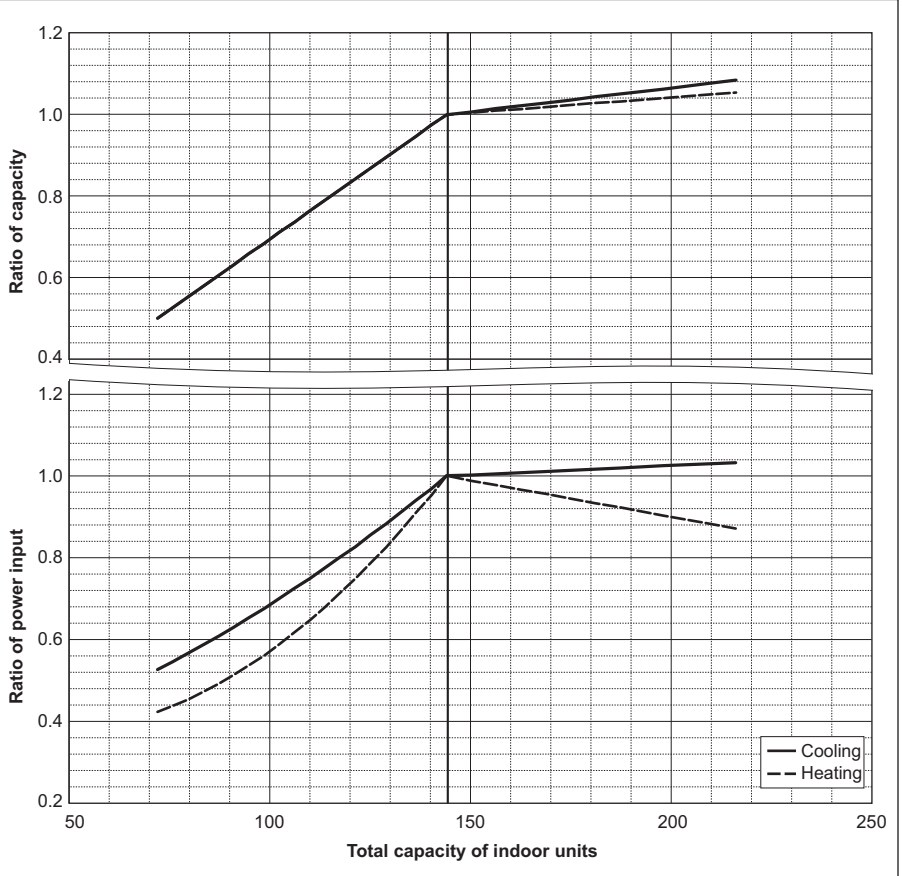

PQRY-P-T(S)LMU-A1, Y(S)LMU-A1

PQRY-P-T(S)LMU-A1, Y(S)LMU-A1

PQRY-		P168TLMU/YLMU	
Nominal cooling capacity	BTU/h	168,000	
	kW	49.2	
Input	kW	12.05	

PQRY-		P168TLMU/YLMU	
Nominal Heating capacity	BTU/h	188,000	
	kW	55.1	
Input	kW	9.86	

PQRY-		P168TSLMU/YSLMU	
Nominal cooling capacity	BTU/h	168,000	
	kW	49.2	
Input	kW	9.33	

PQRY-		P168TSLMU/YSLMU	
Nominal Heating capacity	BTU/h	188,000	
	kW	55.1	
Input	kW	9.34	

PQRY-P168T(S)LMU/Y(S)LMU-A1

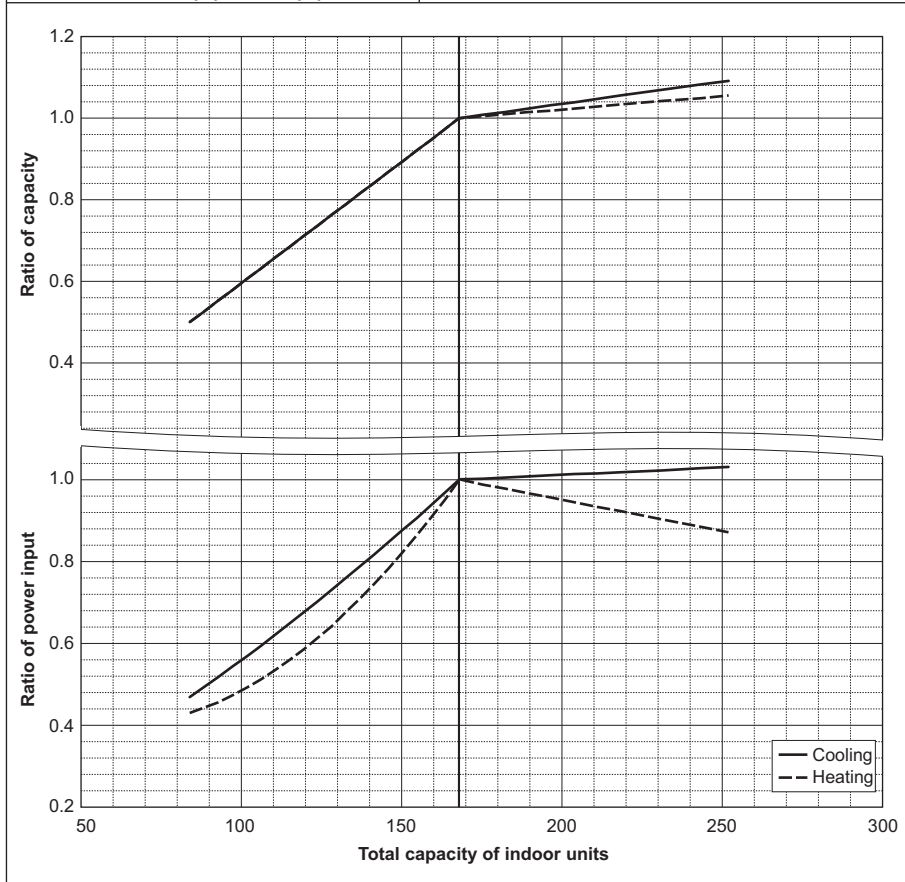

PQRY-		P192TLMU/YLMU	
Nominal cooling capacity	BTU/h	192,000	
	kW	56.3	
Input	kW	15.05	

PQRY-		P192TLMU/YLMU	
Nominal Heating capacity	BTU/h	215,000	
	kW	63.0	
Input	kW	11.90	

PQRY-		P192TSLMU/YSLMU	
Nominal cooling capacity	BTU/h	192,000	
	kW	56.3	
Input	kW	11.30	

PQRY-		P192TSLMU/YSLMU	
Nominal Heating capacity	BTU/h	215,000	
	kW	63.0	
Input	kW	11.02	

PQRY-P192T(S)LMU/Y(S)LMU-A1

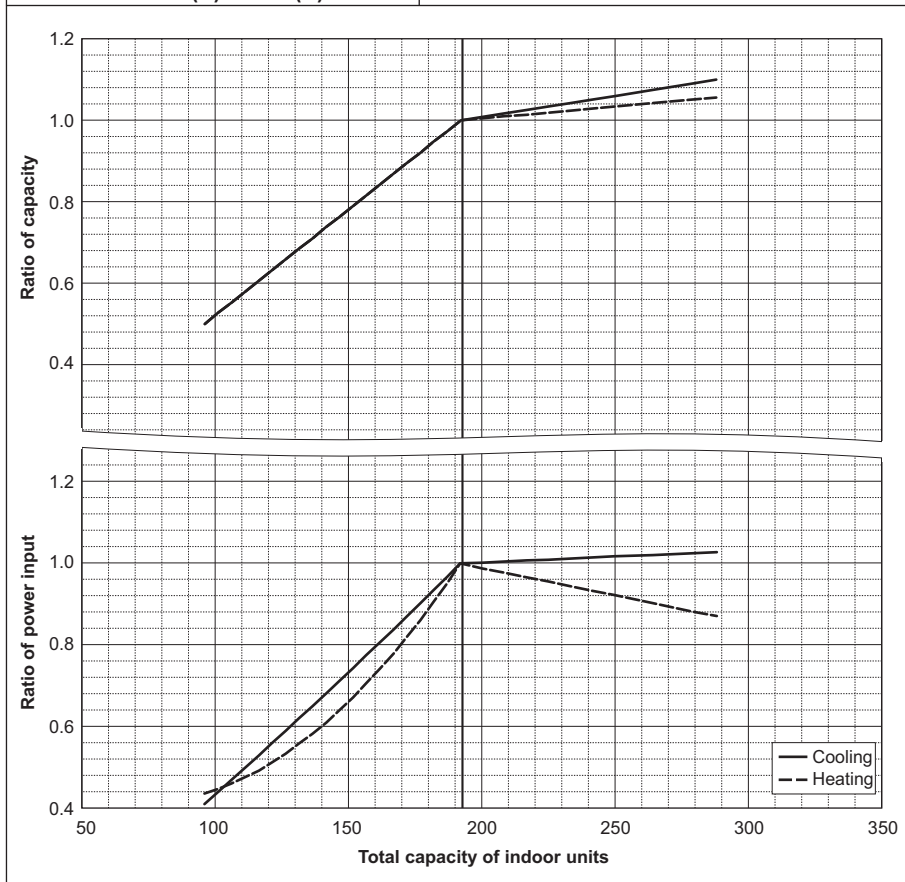

PQRY-		P216TLMU/YLMU	
Nominal cooling capacity	BTU/h	216,000	
	kW	63.3	
	Input kW	19.23	

PQRY-		P216TLMU/YLMU	
Nominal Heating capacity	BTU/h	243,000	
	kW	71.2	
	Input kW	13.04	

PQRY-		P216TSLMU/YSLMU	
Nominal cooling capacity	BTU/h	216,000	
	kW	63.3	
	Input kW	14.03	

PQRY-		P216TSLMU/YSLMU	
Nominal Heating capacity	BTU/h	243,000	
	kW	71.2	
	Input kW	12.88	

PQRY-P216T(S)LMU/Y(S)LMU-A1

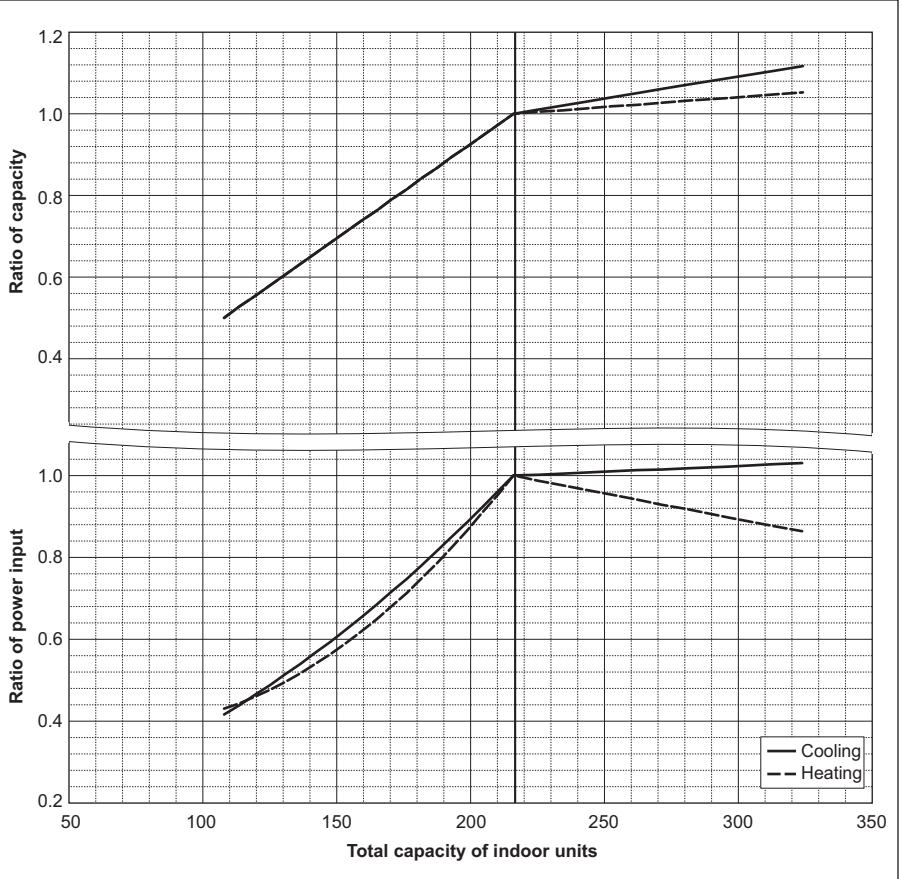

PQRY-		P240TLMU/YLMU	
Nominal cooling capacity	BTU/h	224,000	
	kW	65.7	
	Input kW	21.14	

PQRY-		P240TLMU/YLMU	
Nominal Heating capacity	BTU/h	270,000	
	kW	79.1	
	Input kW	15.12	

PQRY-		P240TSLMU/YSLMU	
Nominal cooling capacity	BTU/h	240,000	
	kW	70.3	
	Input kW	16.89	

PQRY-		P240TSLMU/YSLMU	
Nominal Heating capacity	BTU/h	270,000	
	kW	79.1	
	Input kW	14.58	

PQRY-P240T(S)LMU/Y(S)LMU-A1

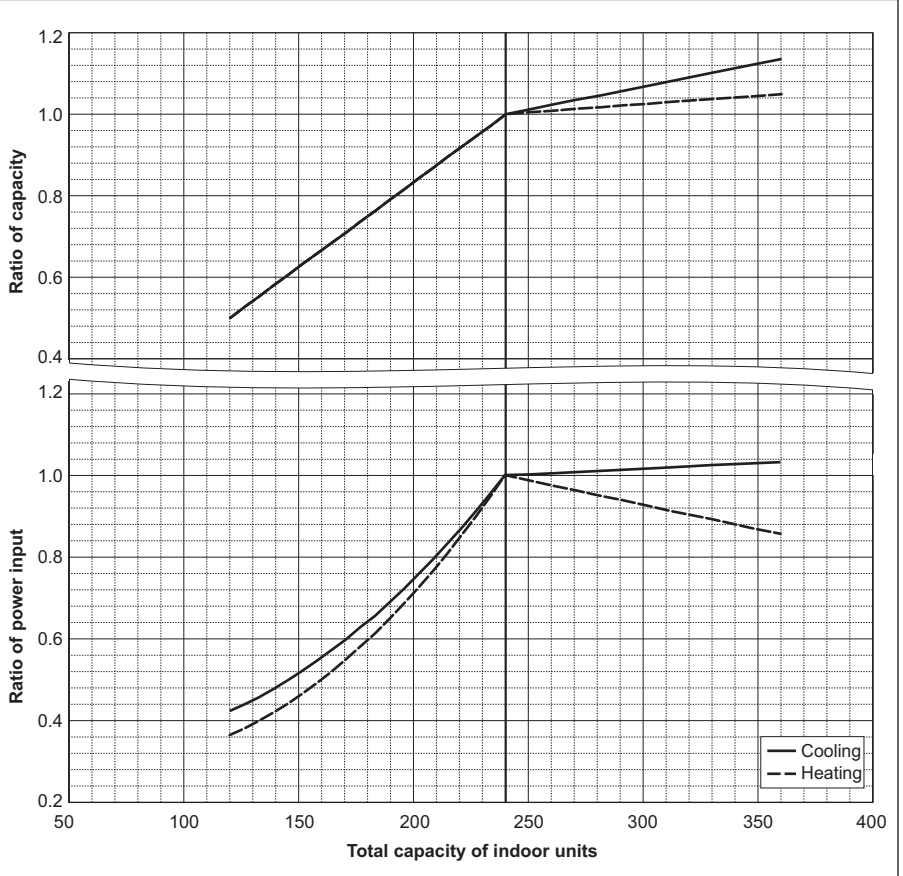

PQRY-P-T(S)LMU-A1, Y(S)LMU-A1

PQRY-P-T(S)LMU-A1, Y(S)LMU-A1

PQRY-		P288TSLMU/YSLMU
Nominal cooling capacity	BTU/h	288,000
	kW	84.4
	Input kW	20.42

PQRY-		P288TSLMU/YSLMU
Nominal Heating capacity	BTU/h	323,000
	kW	94.7
	Input kW	17.50

PQRY-P288TSLMU/YSLMU-A1

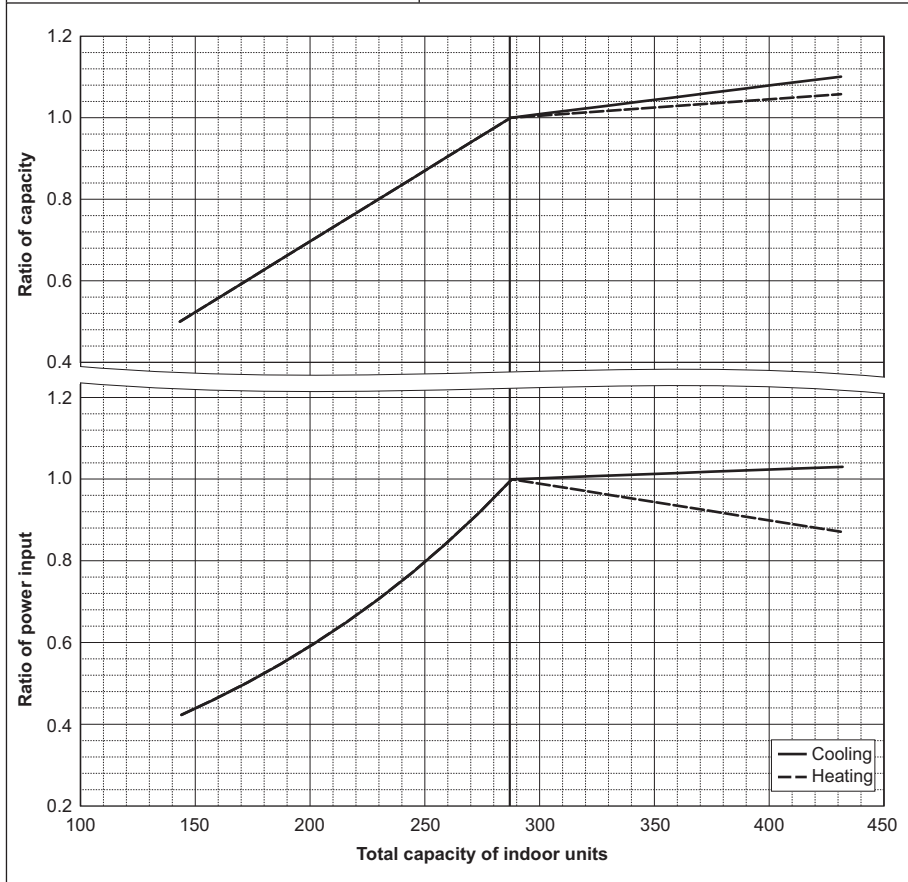

PQRY-		P312TSLMU/YSLMU
Nominal cooling capacity	BTU/h	312,000
	kW	91.4
	Input kW	23.41

PQRY-		P312TSLMU/YSLMU
Nominal Heating capacity	BTU/h	350,000
	kW	102.6
	Input kW	19.11

PQRY-P312TSLMU/YSLMU-A1

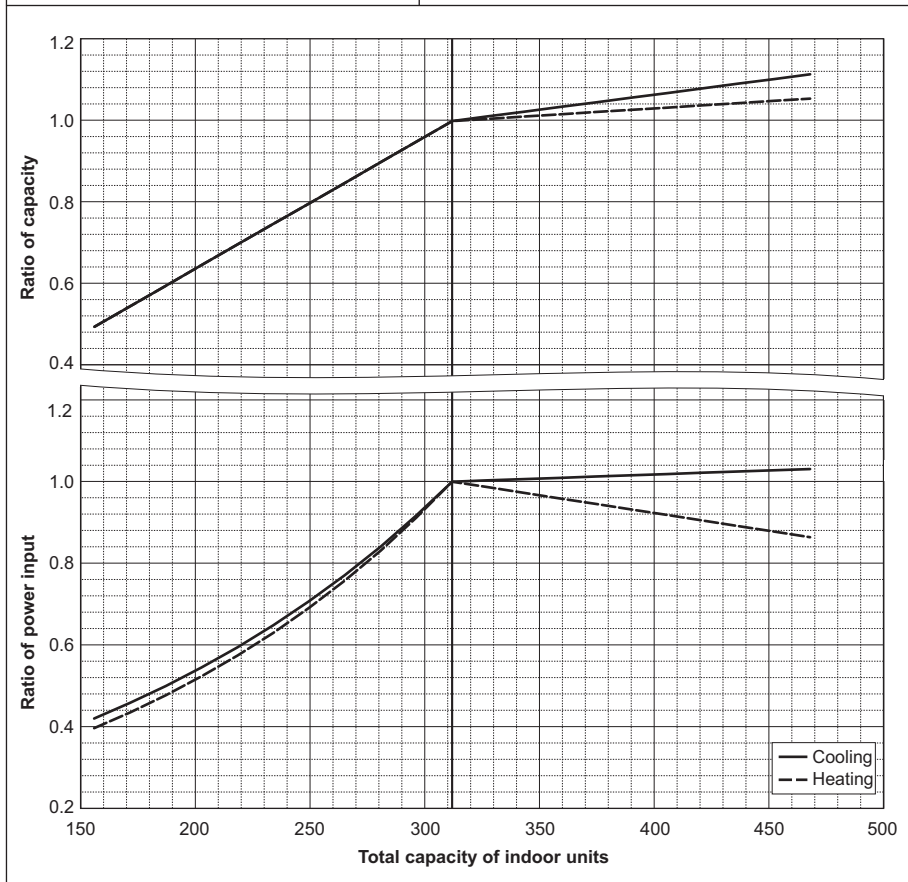

PQRY-		P336TSLMU/YSLMU
Nominal cooling capacity	BTU/h	336,000
	kW	98.5
Input	kW	26.84

PQRY-		P336TSLMU/YSLMU
Nominal Heating capacity	BTU/h	378,000
	kW	110.8
Input	kW	20.77

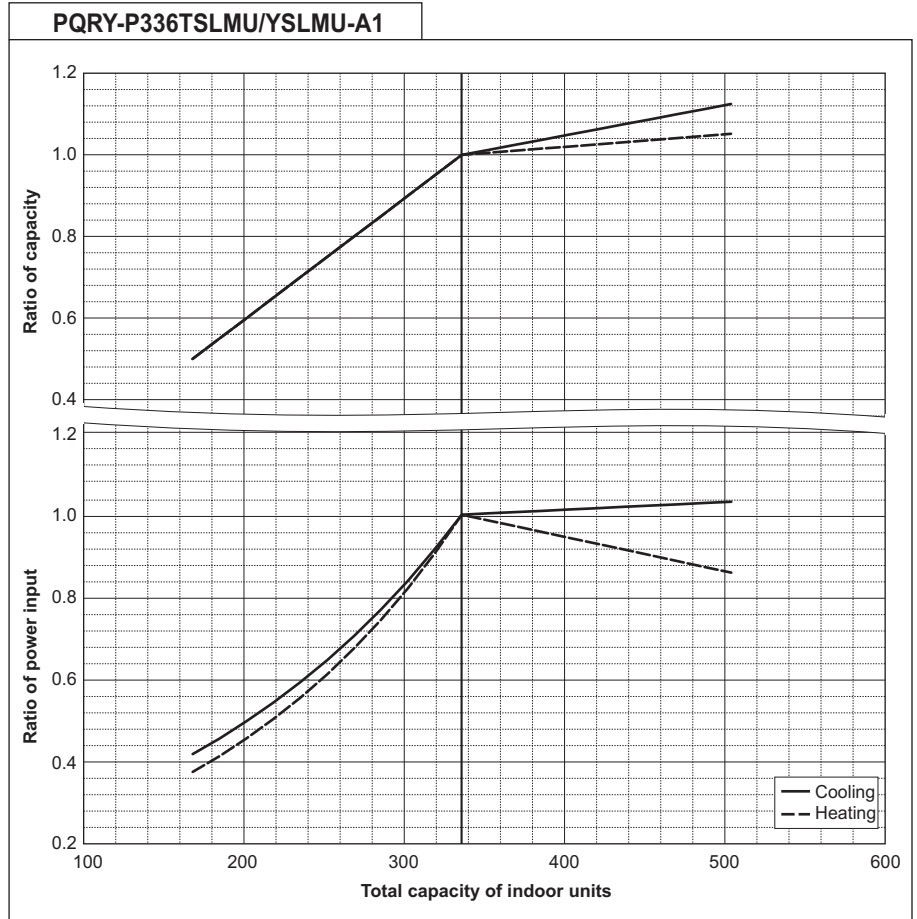

PQRY-P-T(S)LMU-A1, Y(S)LMU-A1

7-3. Correction by refrigerant piping length

CITY MULTI system can extend the piping flexibly within its limitation for the actual situation. However, a decrease of cooling/heating capacity could happen correspondently. Using following correction factor according to the equivalent length of the piping shown at 7-3-1 and 7-3-2, the capacity can be observed. 7-3-3 shows how to obtain the equivalent length of piping.

7-3-1. Cooling capacity correction

PQRY-P-T(S)LMU-A1, Y(S)LMU-A1

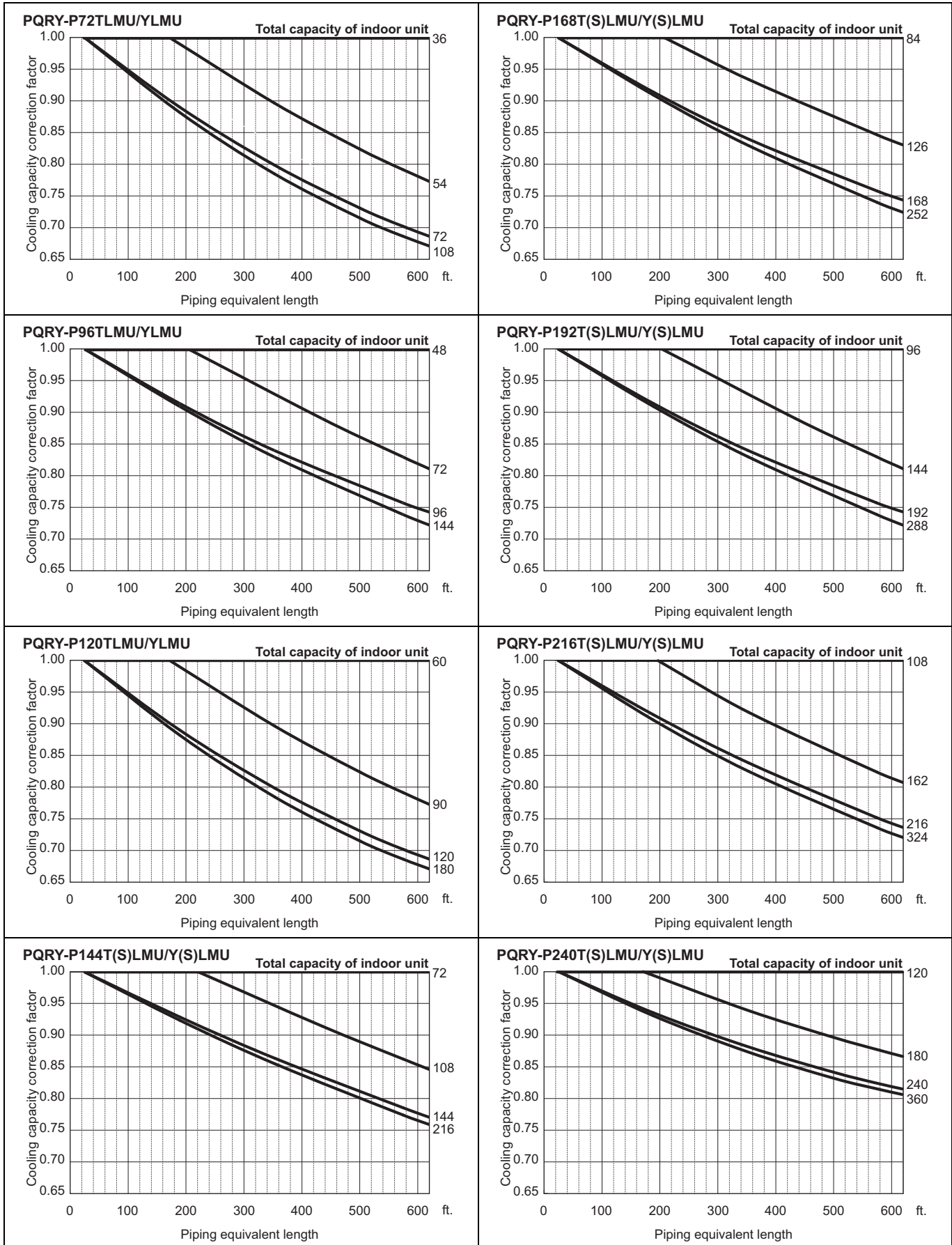

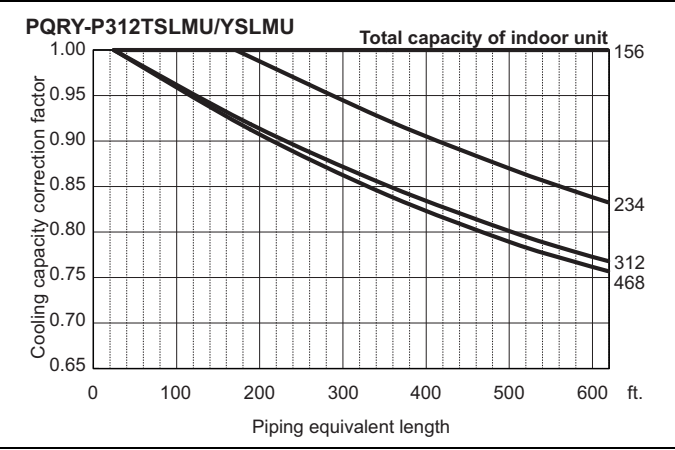
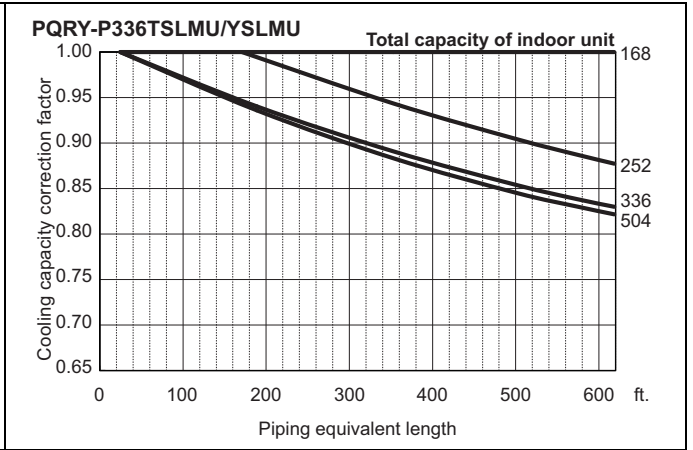
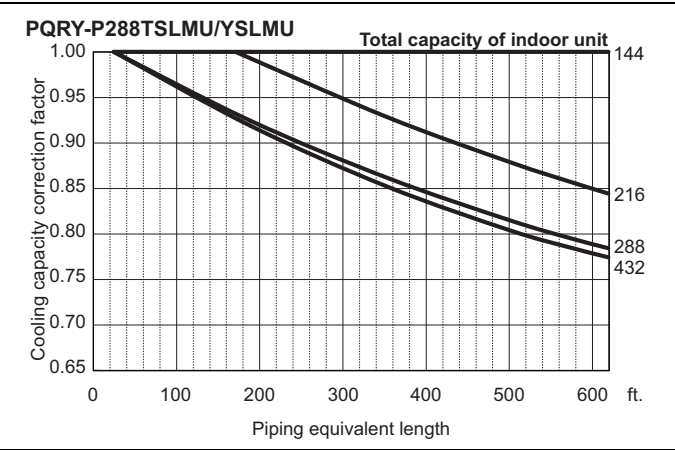

PQRY-P-T(S)LMU-A1, Y(S)LMU-A1

7-3-2. Heating capacity correction

PQRY-P-T(S)LMU-A1, Y(S)LMU-A1

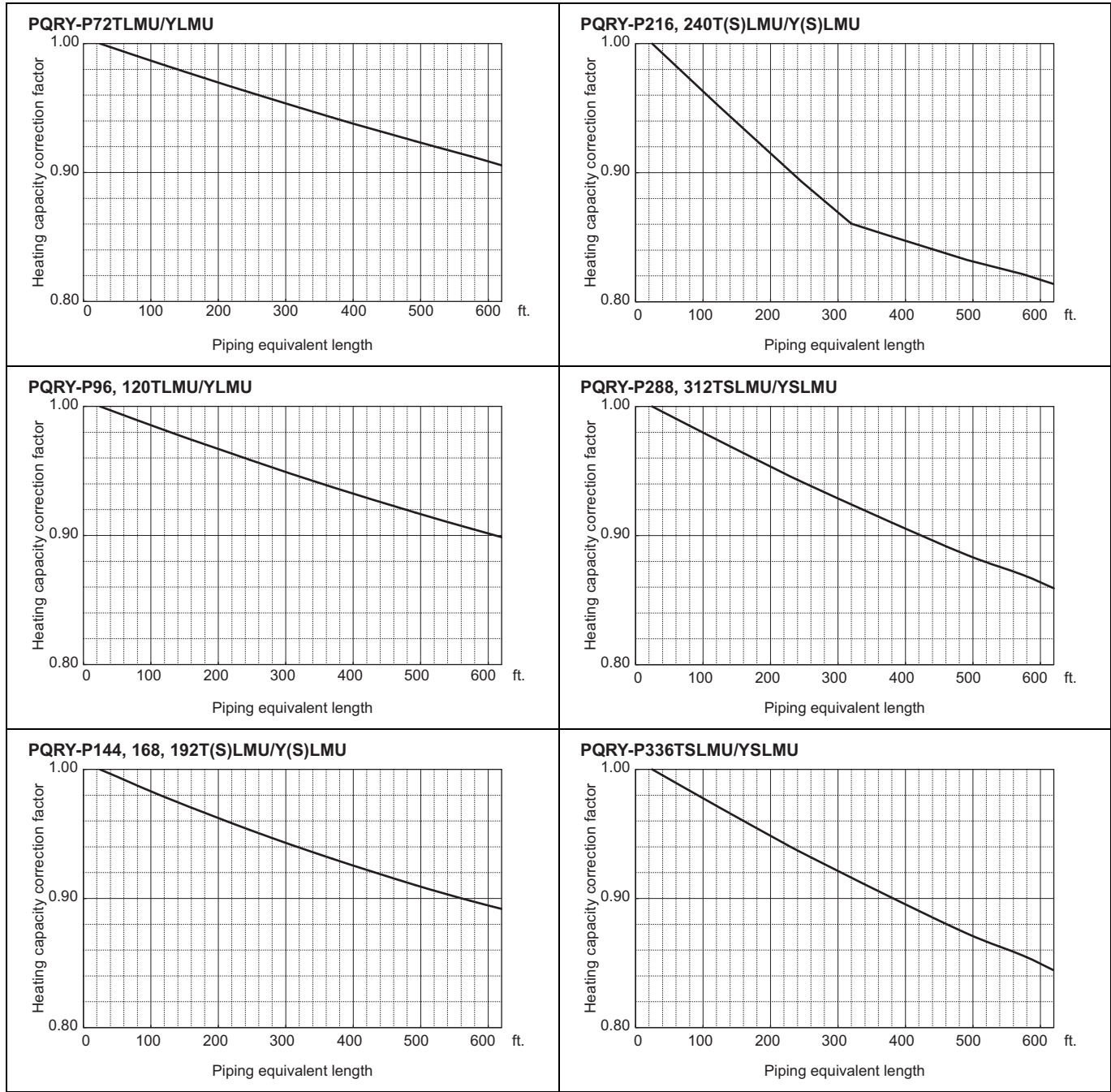

7-3-3. How to obtain the equivalent piping length**1. PQRYP72TLMU/YLMU**

Equivalent length = (Actual piping length to the farthest indoor unit) + (1.15 x number of bent on the piping) [ft.]

Equivalent length = (Actual piping length to the farthest indoor unit) + (0.35 x number of bent on the piping) [m]

2. PQRYP96TLMU/YLMU

Equivalent length = (Actual piping length to the farthest indoor unit) + (1.38 x number of bent on the piping) [ft.]

Equivalent length = (Actual piping length to the farthest indoor unit) + (0.42 x number of bent on the piping) [m]

3. PQRYP120TLMU/YLMU

Equivalent length = (Actual piping length to the farthest indoor unit) + (1.54 x number of bent on the piping) [ft.]

Equivalent length = (Actual piping length to the farthest indoor unit) + (0.47 x number of bent on the piping) [m]

4. PQRYP144, 168, 192, 216, 240T(S)LMU/Y(S)LMU

Equivalent length = (Actual piping length to the farthest indoor unit) + (1.64 x number of bent on the piping) [ft.]

Equivalent length = (Actual piping length to the farthest indoor unit) + (0.50 x number of bent on the piping) [m]

5. PQRYP288, 312TSLMU/YSLMU

Equivalent length = (Actual piping length to the farthest indoor unit) + (2.29 x number of bent on the piping) [ft.]

Equivalent length = (Actual piping length to the farthest indoor unit) + (0.70 x number of bent on the piping) [m]

6. PQRYP336TSLMU/YSLMU

Equivalent length = (Actual piping length to the farthest indoor unit) + (2.70 x number of bent on the piping) [ft.]

Equivalent length = (Actual piping length to the farthest indoor unit) + (0.80 x number of bent on the piping) [m]

PQR-Y-P-T(S)LMU-A1, Y(S)LMU-A1

8-1. Designing of water circuit system

1) Example of basic water circuit

The water circuit of the water heat source CITY MULTI connects the heat source unit with the cooling tower/auxiliary heat source/heat storage tank/circulation pump with a single system water piping as shown in the figure below. The selector valve automatically controls to circulate water toward the cooling tower in the cooling season, while toward the heat storage tank in the heating season. If the inlet water temperature is kept in a range of 10~45°C [50~113°F]* regardless of the building load, the water heat source CITY MULTI can be operated for either cooling or heating. Therefore in the summer when only cooling load exists, the temperature rise of circulation water will be suppressed by operating the cooling tower. While in the winter when heating load increases, the inlet temperature of circulation water may be dropped below 10°C [50°F]. Under such situation, the circulation water will be heated with the auxiliary heat source if it drops below a certain temperature.

When the thermal balance between cooling and heating operation is in a correct proportion, the operation of the auxiliary heat source and cooling tower is not required.

In order to control the above thermal balance properly and use thermal energy effectively, utilizing of heat storage tanks, and night-time discounted electric power as a auxiliary heat source will be economical.

Meantime as this system uses plural sets of heat source unit equipped with water heat exchangers, water quality control is important. Therefore, a cooling tower should be a closed type that water is not exposed to the atmosphere.

Example of basic water circuit for water heat source CITY MULTI

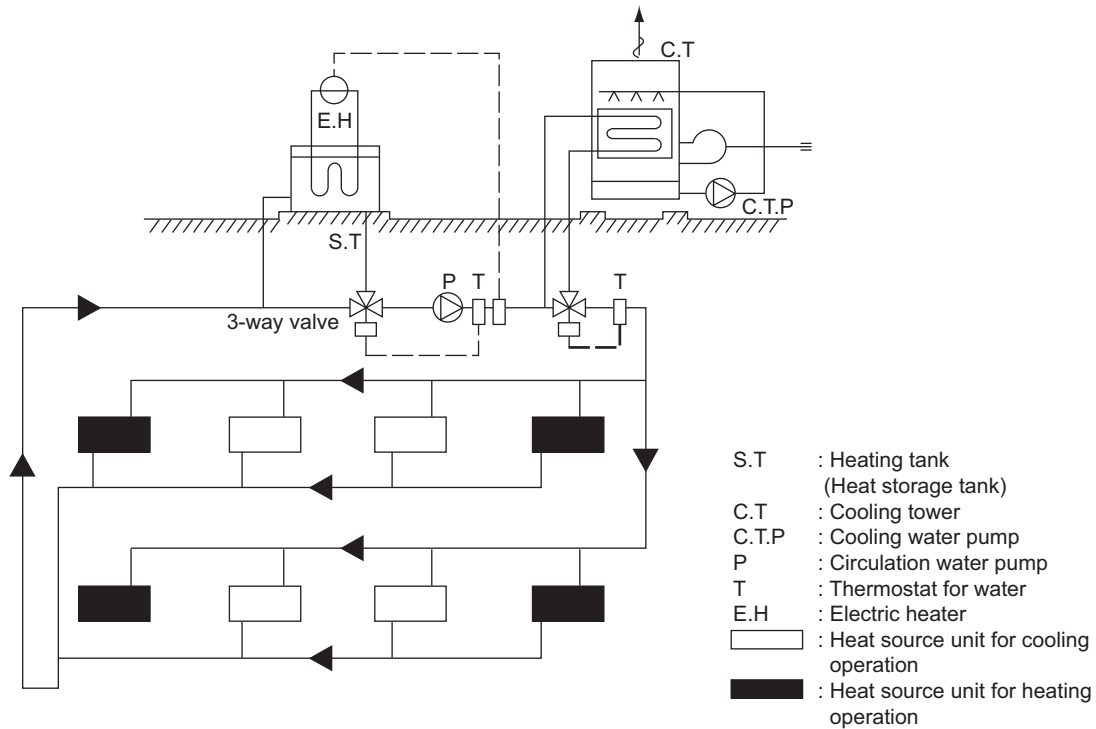

The indoor unit and refrigerant piping system are excluded in this figure.

2) Cooling tower

a) Types of cooling tower

The cooling towers presently used include the open type cooling tower, open type cooling tower + heat exchanger, closed type cooling tower, and air-cooled type cooling tower. However, as the quality control of circulation water is essential, to preserve water quality, use the closed type of cooling tower for WY/WR2.

Although the circulation water will not be contaminated by atmospheric air, it is recommended to periodically blow water inside the system and replenish fresh water instead.

In a district where the coil may be frozen in the winter, it is necessary to apply antifreeze solution to the circulation water, or take freeze protection measures such as to automatically discharge water inside the cooling coil at the stopping of the pump.

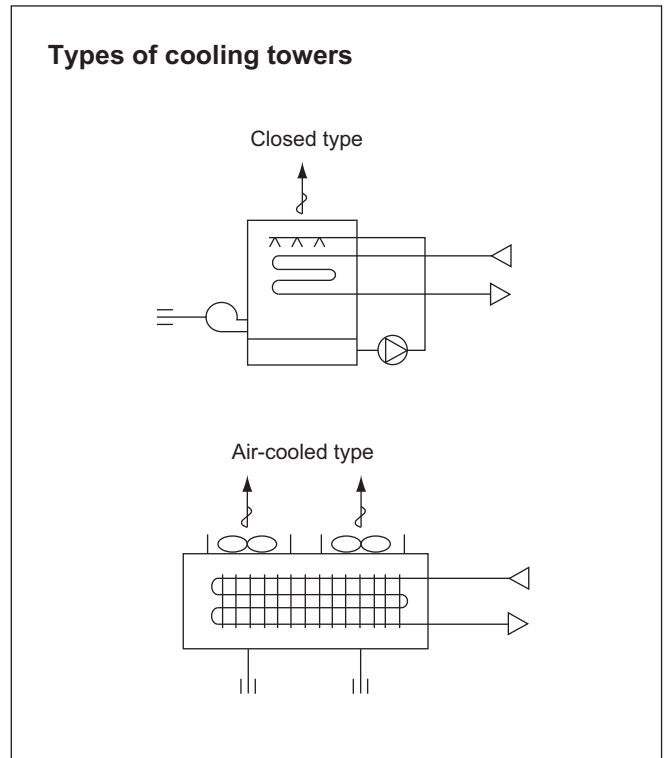

b) Calculation method of cooling tower capacity

All units of the water heat source CITY MULTI may possibly be in cooling operation temporarily (at pulling down) in the summer, however, it is not necessary to determine the capacity according to the total cooling capacity of all CITY MULTI units as this system has a wide operating water temperature range.

It is determined in accordance with the value obtained by adding the maximum cooling load of an actual building, the input heat equivalent value of all CITY MULTI units, and the cooling load of the circulating pumps. Please check for the values of the cooling water volume and circulation water volume.

$$\text{Cooling tower capacity} = \frac{Q_c + 860 \times (\Sigma Q_w + P_w)}{3,900} \text{ (Refrigeration ton)}$$

- Q_c : Maximum cooling load under actual state (kcal/h)
- Q_w : Total input of water heat source CITY MULTI at simultaneous operation under maximum state (kW)
- P_w : Shaft power of circulation pumps (kW)

$$\text{Cooling tower capacity} = \frac{Q_c + 3,412 \times (\Sigma Q_w + P_w)}{15,500} \text{ (Refrigeration ton)}$$

- Q_c : Maximum cooling load under actual state (BTU/h)
- Q_w : Total input of water heat source CITY MULTI at simultaneous operation under maximum state (kW)
- P_w : Shaft power of circulation pumps (kW)

* 1 Refrigerant ton of cooling tower capacity ≈ US refrigerant ton × (1 + 0.3)
= 3,900 kcal/h = 15,500 BTU/h

3) Auxiliary heat source and heat storage tank

When the heating load is larger than the cooling load, the circulation water temperature lowers in accordance with the heat balance of the system. It should be heated by the auxiliary heat source in order to keep the inlet water temperature within the operating range of the water heat source CITY MULTI.

Further in order to operate the water heat source CITY MULTI effectively, it is recommended to utilize the heat storage tank to cover the warming up load in the morning and the insufficient heat amount.

Effective heat utilization can be expected to cover insufficient heat at the warming up in the next morning or peak load time by storing heat by installing a heat storage tank or operating a low load auxiliary heat source at the stopping of the water heat source CITY MULTI. As it can also be possible to reduce the running cost through the heat storage by using the discounted night-time electric power, using both auxiliary heat source and heat storage tank together is recommended. The effective temperature difference of an ordinary heat storage tank shows about 5°C [41°F] even with the storing temperature at 45°C [113°F].

However with the water heat source CITY MULTI, it can be utilized as heating heat source up to 15°C [59°F] with an effective temperature of a high 30°C [54°F] approximately, thus the capacity of the heat storage tank can be minimized.

a) Auxiliary heat source

The following can be used as the auxiliary heat source.

- Boiler (Heavy oil, kerosine, gas, electricity)
- Electric heat (Insertion of electric heater into heat storage tank)
- Outdoor air (Air-heat source heat pump chiller)
- Warm discharge water (Exhaust water heat from machines inside building and hot water supply)
- Utilization of night-time lighting
- Solar heat

Please note that the auxiliary heat source should be selected after studying your operating environment and economical feasibility.

Determining the auxiliary heat source capacity

For the CITY MULTI water heat source system, a heat storage tank is recommended to use. When employment of the heat storage tank is difficult, the warming up operation should be arranged to cover the starting up heating load. Since the holding water inside the piping circuit owns heat capacity and the warming up operation can be assumed for about one hour except that in a cold region, the heat storage tank capacity is required to be that at the maximum daily heating load including the warming up load at the next morning of the holiday. However the auxiliary heat source capacity should be determined by the daily heating load including warming up load on the week day. For the load at the next morning of the holiday, heat storage is required by operating the auxiliary heat source even outside of the ordinary working hour.

When heat storage tank is not used

$$QH = HCT \left(1 - \frac{1}{COP_h} \right) - 1000 \times V_w \times \Delta T - 860 \times P_w$$

QH	: Auxiliary heat source capacity	(kcal/h)
HCT	: Total heating capacity of each water heat source CITY MULTI	(kcal/h)
COP _H	: COP of water heat source CITY MULTI at heating	
V _w	: Holding water volume inside piping	(m ³)
ΔT	: Allowable water temperature drop = T _{WH} - T _{WL}	(°C)
T _{WH}	: Heat source water temperature at high temperature side	(°C)
T _{WL}	: Heat source water temperature at low temperature side	(°C)
P _w	: Heat source water pump shaft power	(kW)

$$QH = HCT \left(1 - \frac{1}{COP_h} \right) - 8.343 \times V_w \times \Delta T - 3412 \times P_w$$

QH	: Auxiliary heat source capacity	(BTU/h)
HCT	: Total heating capacity of each water heat source CITY MULTI	(BTU/h)
COP _H	: COP of water heat source CITY MULTI at heating	
V _w	: Holding water volume inside piping	(G)
ΔT	: Allowable water temperature drop = T _{WH} - T _{WL}	(°F)
T _{WH}	: Heat source water temperature at high temperature side	(°F)
T _{WL}	: Heat source water temperature at low temperature side	(°F)
P _w	: Heat source water pump shaft power	(kW)

When heat storage tank is not used

$$QH = \frac{HQ_{1T} \cdot \left(1 - \frac{1}{COP_h}\right) - 860 \times P_w \times T_2}{T_1} \times K \quad (\text{kcal})$$

QH_{1T}	: Total of heating load on weekday including warming up	(kcal/day)
T_1	: Operating hour of auxiliary heat source	(h)
T_2	: Operating hour of heat source water pump	(h)
K	: Allowance factor (Heat storage tank, piping loss, etc.)	1.05~1.10

HQ_{1T} is calculated from the result of steady state load calculation similarly by using the equation below.

$$HQ_{1T} = 1.15 \times (\Sigma Q'a + \Sigma Q'b + \Sigma Q'c + \Sigma Q'd + \Sigma Q'f) T_2 - \psi (\Sigma Qe_1 + \Sigma Qe_2 + \Sigma Qe_3) (T_2 - 1)$$

$Q'a$: Thermal load from external wall/roof in each zone	(kcal/h)
$Q'b$: Thermal load from glass window in each zone	(kcal/h)
$Q'c$: Thermal load from partition/ceiling/floor in each zone	(kcal/h)
$Q'd$: Thermal load by infiltration in each zone	(kcal/h)
$Q'f$: Fresh outdoor air load in each zone	(kcal/h)
$Q'e_1$: Thermal load from human body in each zone	(kcal/h)
$Q'e_2$: Thermal load from lighting fixture in each zone	(kcal/h)
$Q'e_3$: Thermal load from equipment in each zone	(kcal/h)
ψ	: Radiation load rate	0.6~0.8
T_2	: Air conditioning hour	

$$QH = \frac{HQ_{1T} \cdot \left(1 - \frac{1}{COP_h}\right) - 3,412 \times P_w \times T_2}{T_1} \times K \quad (\text{BTU})$$

QH_{1T}	: Total of heating load on weekday including warming up	(BTU/day)
T_1	: Operating hour of auxiliary heat source	(h)
T_2	: Operating hour of heat source water pump	(h)
K	: Allowance factor (Heat storage tank, piping loss, etc.)	1.05~1.10

HQ_{1T} is calculated from the result of steady state load calculation similarly by using the equation below.

$$HQ_{1T} = 1.15 \times (\Sigma Q'a + \Sigma Q'b + \Sigma Q'c + \Sigma Q'd + \Sigma Q'f) T_2 - \psi (\Sigma Qe_1 + \Sigma Qe_2 + \Sigma Qe_3) (T_2 - 1)$$

$Q'a$: Thermal load from external wall/roof in each zone	(BTU/h)
$Q'b$: Thermal load from glass window in each zone	(BTU/h)
$Q'c$: Thermal load from partition/ceiling/floor in each zone	(BTU/h)
$Q'd$: Thermal load by infiltration in each zone	(BTU/h)
$Q'f$: Fresh outdoor air load in each zone	(BTU/h)
$Q'e_1$: Thermal load from human body in each zone	(BTU/h)
$Q'e_2$: Thermal load from lighting fixture in each zone	(BTU/h)
$Q'e_3$: Thermal load from equipment in each zone	(BTU/h)
ψ	: Radiation load rate	0.6~0.8
T_2	: Air conditioning hour	

b) Heat storage tank

Heat storage tank can be classified by types into the open type heat storage tank exposed to atmosphere, and the closed type heat storage tank with structure separated from atmosphere. Although the size of the tank and its installation place should be taken into account, the closed type tank should be used by considering corrosion problems.

The capacity of heat storage tanks is determined in accordance with the daily maximum heating load that includes warming up load to be applied for the day after the holiday.

When auxiliary heat source is operated during operation and even after stopping of water heat source CITY MULTI unit

$$V = \frac{HQ_{2T} \left(1 - \frac{1}{COP_h} \right) - 860 \times P_w \times T_2 - Q_H \times T_2}{\Delta T \times 1,000 \times \eta V} \quad (\text{ton})$$

HQ_{2T} : Maximum heating load including load required for the day after the holiday (kcal/day)

ΔT : Temperature difference utilized by heat storage tank ($^{\circ}\text{C}$)

ηV : Heat storage tank efficiency

$$HQ_{2T} : 1.3 \times (\Sigma Q'a + \Sigma Q'c + \Sigma Q'd + \Sigma Q'f) T_2 - \psi (\Sigma Qe2 + \Sigma Qe3) (T_2 - 1)$$

$$V = \frac{HQ_{2T} \left(1 - \frac{1}{COP_h} \right) - 3,412 \times P_w \times T_2 - Q_H \times T_2}{\Delta T \times \eta V} \quad (\text{lbs})$$

HQ_{2T} : Maximum heating load including load required for the day after the holiday (BTU/day)

ΔT : Temperature difference utilized by heat storage tank ($^{\circ}\text{F}$)

ηV : Heat storage tank efficiency

$$HQ_{2T} : 1.3 \times (\Sigma Q'a + \Sigma Q'c + \Sigma Q'd + \Sigma Q'f) T_2 - \psi (\Sigma Qe2 + \Sigma Qe3) (T_2 - 1)$$

When auxiliary heat source is operated after stopping of water heat source CITY MULTI unit

$$V = \frac{HQ_{2T} \left(1 - \frac{1}{COP_h} \right) - 860 \times P_w \times T_2}{\Delta T \times 1,000 \times \eta V} \quad (\text{ton})$$

HQ_{2T} : Maximum heating load including load required for the day after the holiday (kcal/day)

ΔT : Temperature difference utilized by heat storage tank ($^{\circ}\text{C}$)

ηV : Heat storage tank efficiency

$$HQ_{2T} : 1.3 \times (\Sigma Q'a + \Sigma Q'c + \Sigma Q'd + \Sigma Q'f) T_2 - \psi (\Sigma Qe2 + \Sigma Qe3) (T_2 - 1)$$

$$V = \frac{HQ_{2T} \left(1 - \frac{1}{COP_h} \right) - 3,412 \times P_w \times T_2}{\Delta T \times \eta V} \quad (\text{lbs})$$

HQ_{2T} : Maximum heating load including load required for the day after the holiday (BTU/day)

ΔT : Temperature difference utilized by heat storage tank ($^{\circ}\text{F}$)

ηV : Heat storage tank efficiency

$$HQ_{2T} : 1.3 \times (\Sigma Q'a + \Sigma Q'c + \Sigma Q'd + \Sigma Q'f) T_2 - \psi (\Sigma Qe2 + \Sigma Qe3) (T_2 - 1)$$

4) Piping system

The following items should be kept in your mind in planning / designing water circuits.

- a) All units should be constituted in a single circuit in principle.
- b) When plural numbers of the water heat source CITY MULTI unit are installed, the rated circulating water flow rate should be kept by making the piping resistance to each unit almost same value. As an example, the reverse return system as shown below may be employed.
- c) Depending on the structure of a building, the water circuit may be prefabricated by making the layout uniform.
- d) When a closed type piping circuit is constructed, install an expansion tank usable commonly for a make-up water tank to absorb the expansion/contraction of water caused by temperature fluctuation.
- e) If the operating temperature range of circulation water stays within the temperature near the normal temperature (summer :30°C [86°F], winter :20°C [68°F]), thermal insulation or anti-sweating work is not required for the piping inside buildings.

In case of the conditions below, however, thermal insulation is required.

- When well water is used for heat source water.
- When piped to outdoor or a place where freezing may be caused.
- When vapor condensation may be generated on piping due to an increase in dry bulb temperature caused by the entry of fresh outdoor air.

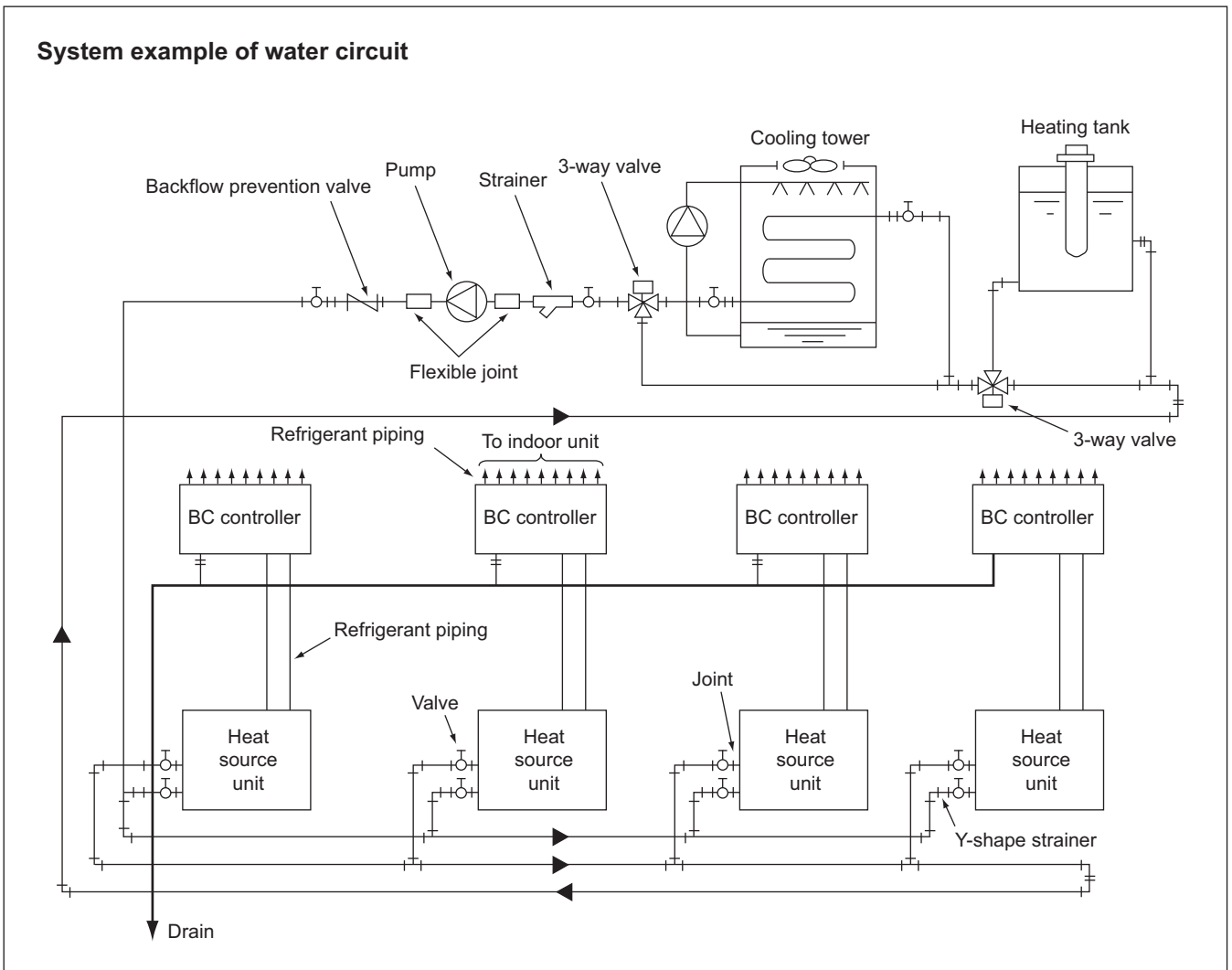

5) Practical System Examples and Circulation Water Control

Since the water heat source CITY MULTI is of water heat source system, versatile systems can be constituted by combining it with various heat sources.

The practical system examples are given below.

Either cooling or heating operation can be performed if the inlet water temperature of the water heat source CITY MULTI stays within a range of 10~45°C [50~113°F]. However, the inlet water temperature near 30°C [86°F] for cooling and 20°C [68°F] for heating is recommended by taking the life, power consumption and capacity of the air conditioning units into consideration. The detail of the control is also shown below.

Example-1 Combination of closed type cooling tower and hot water heat storage tank (using underground hollow slab)

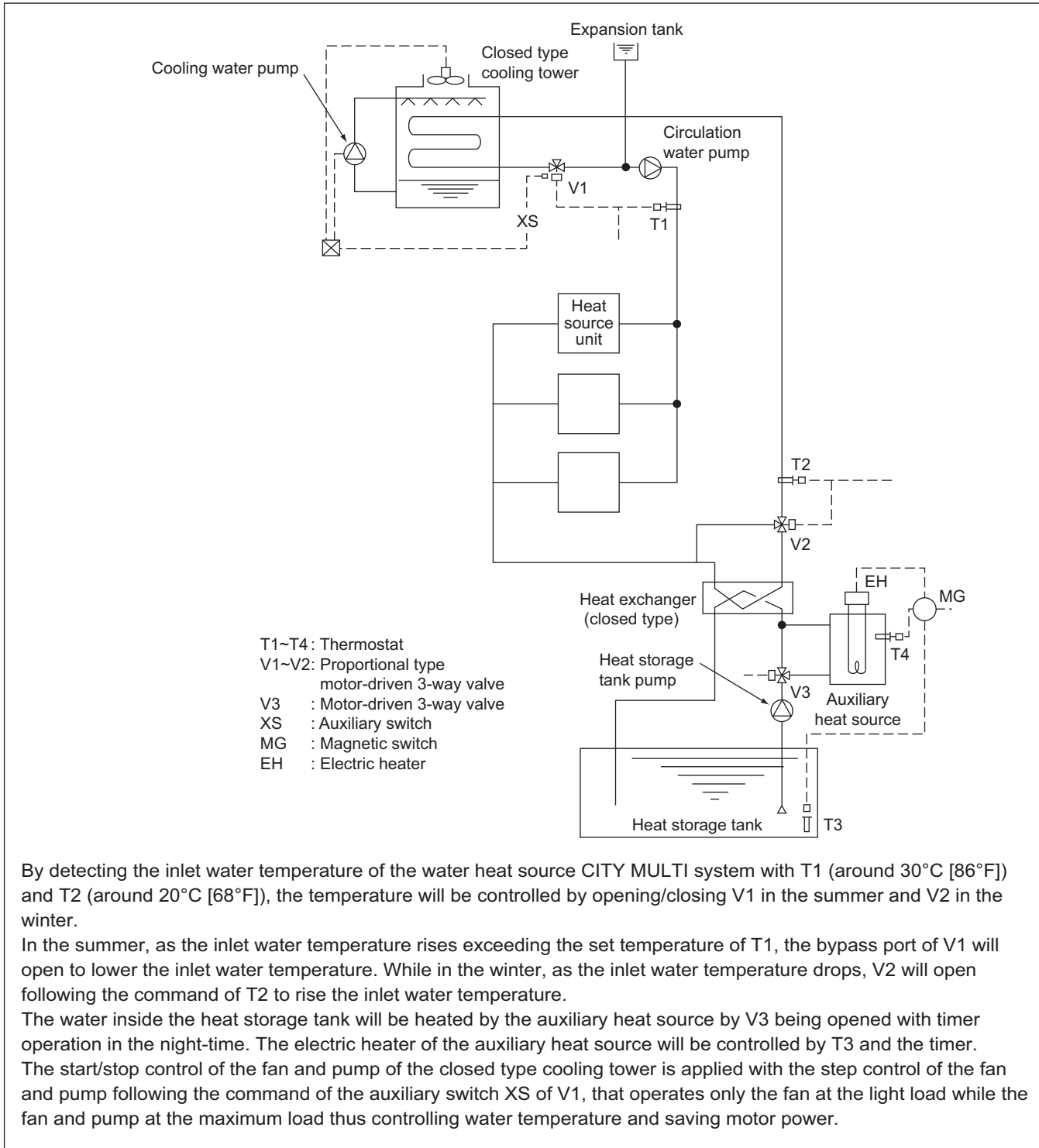

By detecting the inlet water temperature of the water heat source CITY MULTI system with T1 (around 30°C [86°F]) and T2 (around 20°C [68°F]), the temperature will be controlled by opening/closing V1 in the summer and V2 in the winter.

In the summer, as the inlet water temperature rises exceeding the set temperature of T1, the bypass port of V1 will open to lower the inlet water temperature. While in the winter, as the inlet water temperature drops, V2 will open following the command of T2 to rise the inlet water temperature.

The water inside the heat storage tank will be heated by the auxiliary heat source by V3 being opened with timer operation in the night-time. The electric heater of the auxiliary heat source will be controlled by T3 and the timer.

The start/stop control of the fan and pump of the closed type cooling tower is applied with the step control of the fan and pump following the command of the auxiliary switch XS of V1, that operates only the fan at the light load while the fan and pump at the maximum load thus controlling water temperature and saving motor power.

PQRY-P-T(S)LMU-A1, Y(S)LMU-A1

Example-2 Combination of closed type cooling tower and hot water heat storage tank

- T1 : Proportional type, insertion system thermostat
 T2 : Proportional type, insertion system thermostat
 T3 : Proportional type, insertion system thermostat
 V1 : Proportional type, motor-driven 3-way valve
 V2 : Proportional type, motor-driven 3-way valve
 XS : Auxiliary switch (Duplex switch type)
 SC : Step controller
 R : Relay
 MG : Magnetic

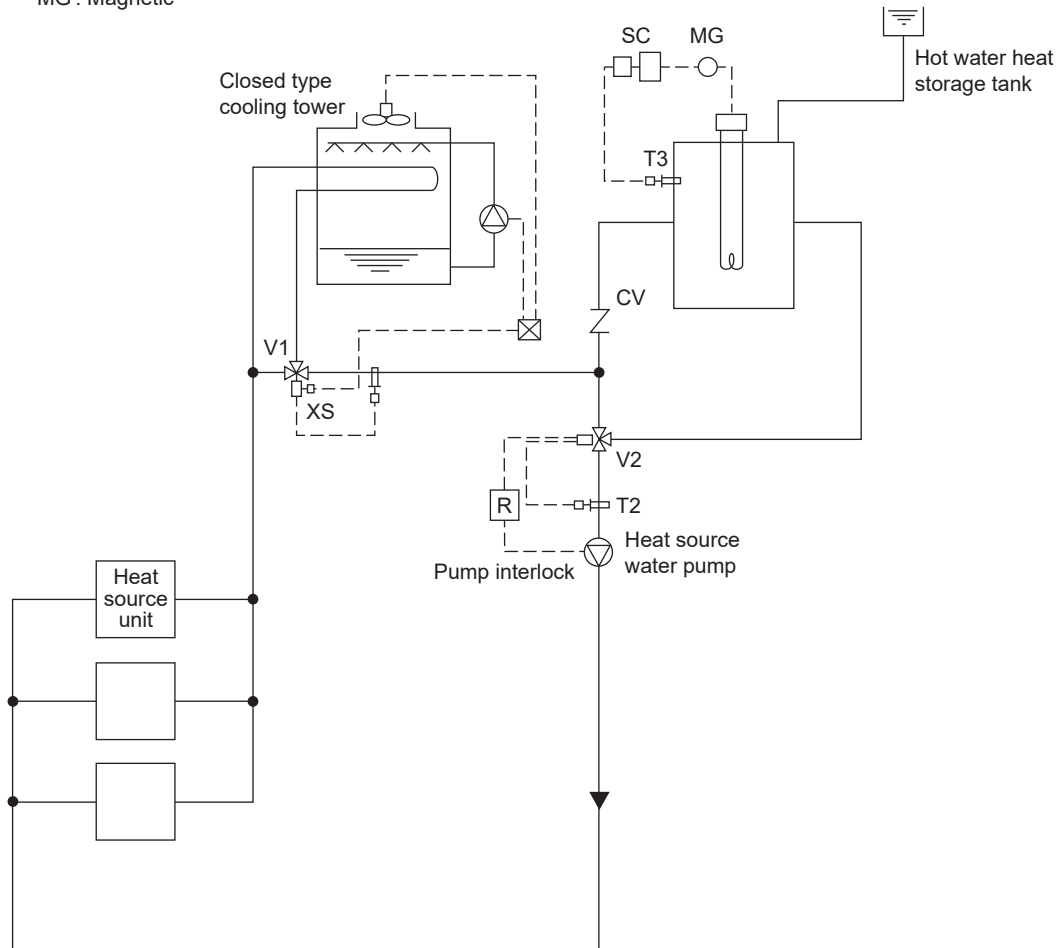

In the summer, as the inlet water temperature rises exceeding the set temperature of T1, the bypass port of V1 will open to lower the inlet water temperature. In the winter, if the inlet water temperature stays below 25°C [77°F], V2 will open/close by the command of T2 to keep the inlet water temperature constant.

The temperature of the hot water inside the heat storage tank will be controlled through the step control of the electric heater by step controller operation following the command of T3.

During the stopping of the heat source water pump, the bypass port of V2 will be closed fully by interlocking thus preventing the high temperature water from entering into the system at the starting of the pump.

The start/stop control of the fan and pump of the closed type cooling tower is applied with the step control of the fan and pump following the command of the auxiliary switch XS of V1, that operates only the fan at the light load while the fan and pump at the maximum load thus controlling water temperature and saving motor power.

Example-3 Combination of closed type cooling tower and boiler

- T1 : Proportional type, insertion system thermostat
- T2 : Proportional type, insertion system thermostat
- T3 : Proportional type, insertion system thermostat
- V1 : Proportional type, motor-driven 3-way valve
- S : Selector switch
- R : Relay
- XS : Auxiliary switch (Duplex switch type)

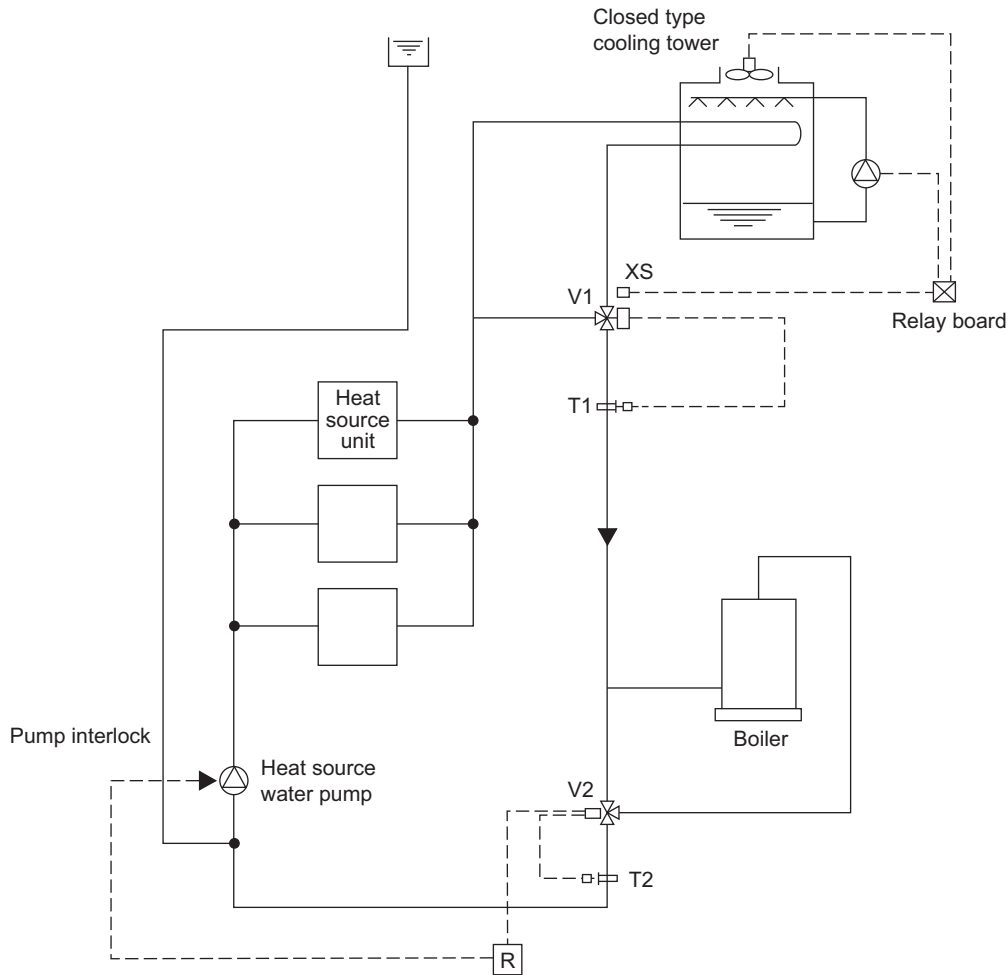

In the summer, as the inlet water temperature rises exceeding the set temperature of T1, the bypass port of V1 will close to lower the inlet water temperature. In the winter, if the inlet water temperature drops below 25°C [77°F], V2 will conduct water temperature control to keep the inlet water temperature constant.

During the stopping of the heat source water pump, the bypass port of V2 will be closed fully by interlocking.

The start/stop control of the fan and pump of the closed type cooling tower is applied with the step control following the command of the auxiliary switch XS of V1, thus controlling water temperature and saving motor power.

PQRY-P-T(S)LMU-A1, Y(S)LMU-A1

Example-4 Combination of closed type cooling tower and heat exchanger (of other heat source)

- T1 : Proportional type, insertion system thermostat
- T2 : Proportional type, insertion system thermostat
- V1 : Proportional type, motor-driven 3-way valve
- V2 : Proportional type, motor-driven 3-way valve
- S : Selector switch
- R : Relay
- XS : Auxiliary switch (Duplex switch type)

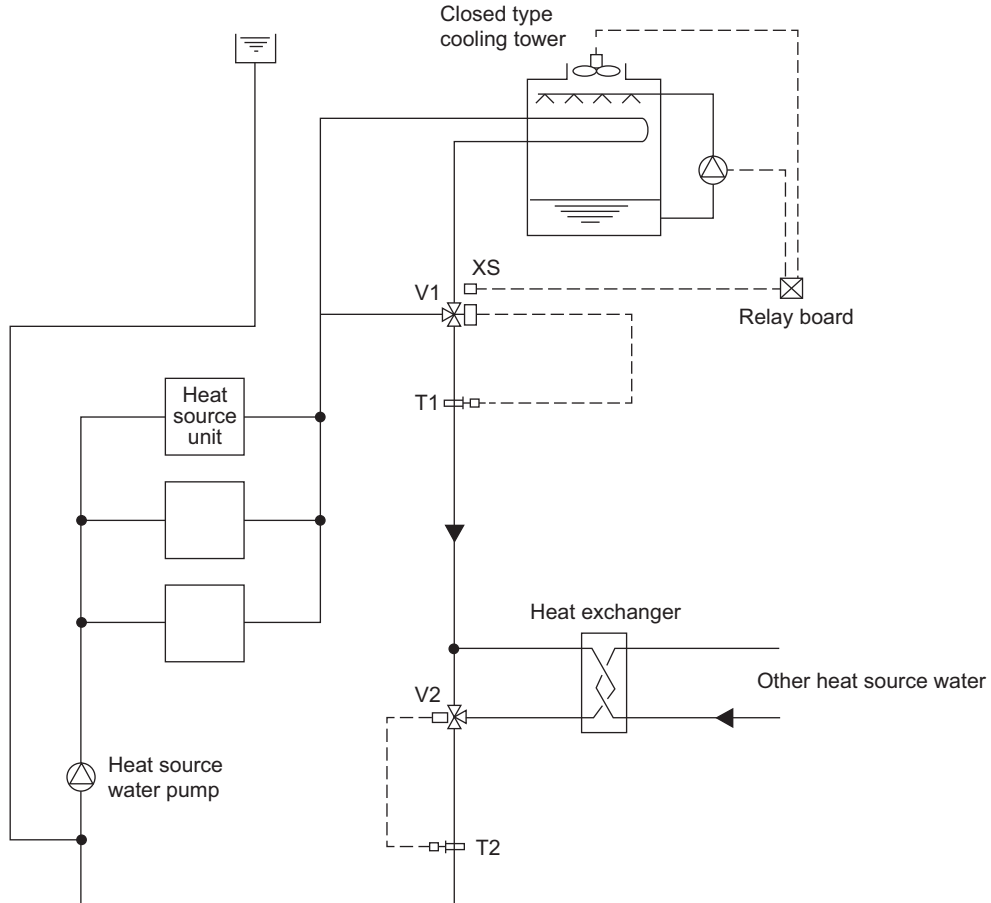

In the summer, as the inlet water temperature rises exceeding the set temperature of T1, the bypass port of V1 will close to lower the inlet water temperature. In the winter, if the inlet water temperature drops below 26°C [79°F], V2 will conduct water temperature control to keep the inlet water temperature constant.

During the stopping of the heat source water pump, the bypass port of V2 will be closed fully by interlocking.

The start/stop control of the fan and pump of the closed type cooling tower is applied with the step control following the command of the auxiliary switch XS of V1, thus controlling water temperature and saving motor power.

6) Pump interlock circuit

PQRY-P-T(S)LMU-A1, Y(S)LMU-A1

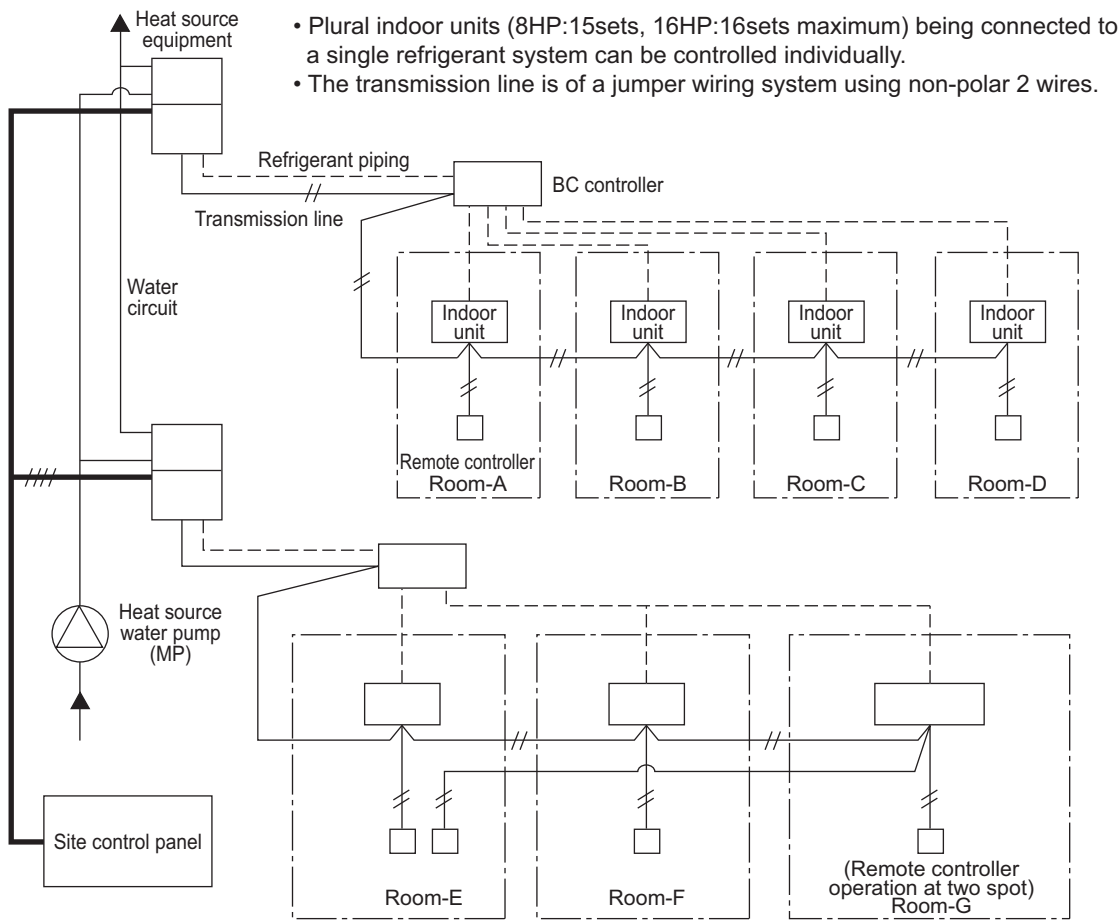

- Plural indoor units (8HP:15sets, 16HP:16sets maximum) being connected to a single refrigerant system can be controlled individually.
- The transmission line is of a jumper wiring system using non-polar 2 wires.

Wiring diagram

This circuit uses the "Terminal block for pump interlock (TB8)" inside the electrical parts box of the heat source equipment. This circuit is for interlocking the heat source equipment operation and the heat source water pump.

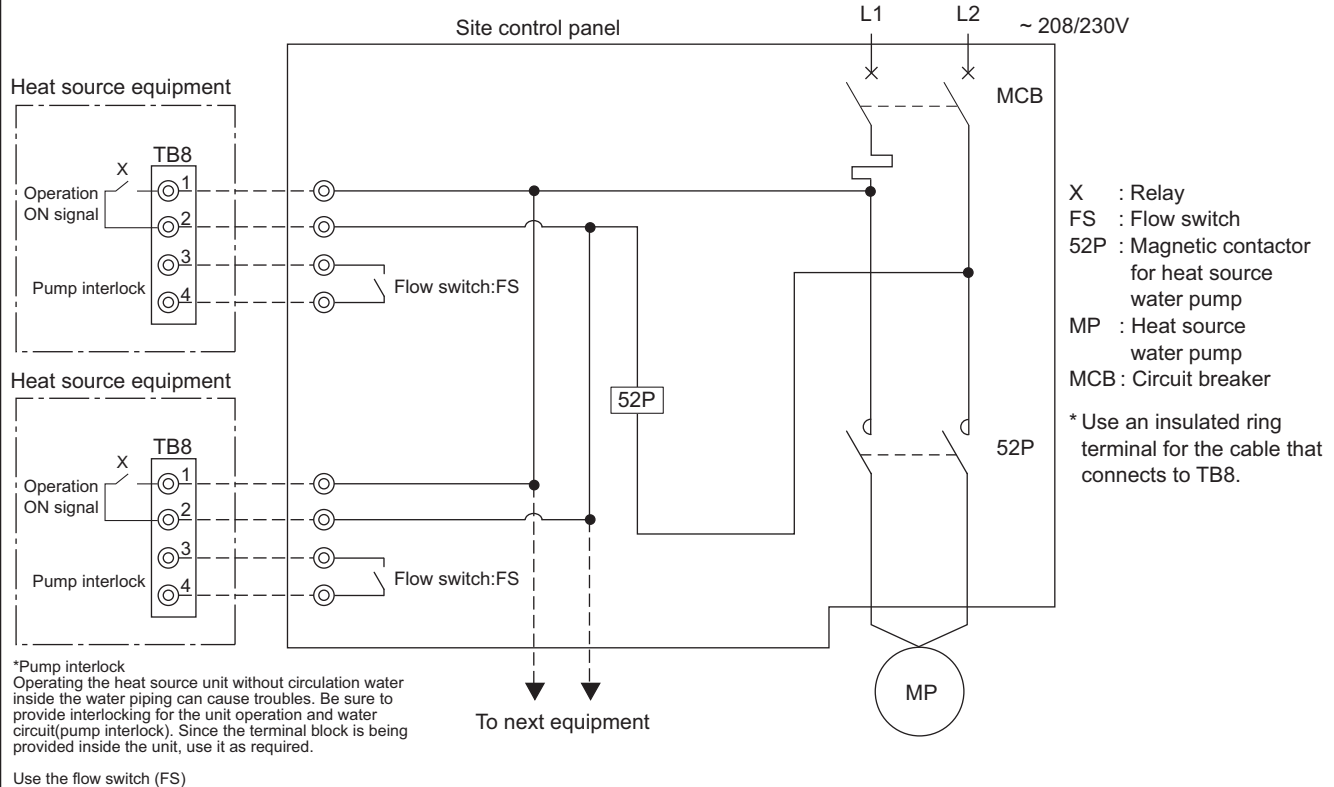

- X : Relay
- FS : Flow switch
- 52P : Magnetic contactor for heat source water pump
- MP : Heat source water pump
- MCB : Circuit breaker

* Use an insulated ring terminal for the cable that connects to TB8.

*Pump interlock
Operating the heat source unit without circulation water inside the water piping can cause troubles. Be sure to provide interlocking for the unit operation and water circuit(pump interlock). Since the terminal block is being provided inside the unit, use it as required.

Use the flow switch (FS)

Operation ON signal

Terminal No.	TB8-1, 2																														
Output	Relay contacts output Rated voltage: 3~: 208/230V Rated load: 1 A																														
Operation	<ul style="list-style-type: none"> When setting No.917 for Dip switch 4 (Dip switch 6-10 is ON) is OFF. The relay closes during compressor operation. <table border="1" style="margin-left: auto; margin-right: auto;"> <tr> <th colspan="10">SW4 0: OFF, 1: ON</th> </tr> <tr> <td>1</td><td>2</td><td>3</td><td>4</td><td>5</td><td>6</td><td>7</td><td>8</td><td>9</td><td>10</td> </tr> <tr> <td>1</td><td>0</td><td>1</td><td>0</td><td>1</td><td>0</td><td>0</td><td>1</td><td>1</td><td>1</td> </tr> </table> <ul style="list-style-type: none"> When setting No.917 for Dip switch 4 (Dip switch 6-10 is ON) is ON. The relay closes during reception of cooling or the heating operation signal from the controller. (Note: It is output even if the thermostat is OFF (when the compressor is stopped).) 	SW4 0: OFF, 1: ON										1	2	3	4	5	6	7	8	9	10	1	0	1	0	1	0	0	1	1	1
SW4 0: OFF, 1: ON																															
1	2	3	4	5	6	7	8	9	10																						
1	0	1	0	1	0	0	1	1	1																						

Pump Interlock

Terminal No.	TB8-3, 4
Input	Level signal
Operation	If the circuit between TB8-3 and TB8-4 is open, compressor operation is prohibited.

*Remove the short circuit wire between 3 and 4 when wiring to TB8.
To prevent a false detection of error resulting from contact failure, use a flow switch with a minimum guaranteed current of 5 mA or below for FS.

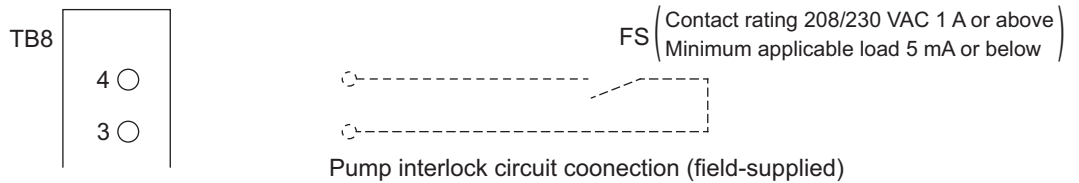

7) Water flow rate control

The function described here calculates the amount of circulating water required for the heat-exchanger unit based on the operation status of the heat-exchanger, and then outputs signals that adjust the water control valve. Signals requesting to decrease the water control valve opening are output when the heat-source unit is in partial-load operation, which decreases the amount of circulating water supplied to the heat-source unit and helps reduce the power required to operate the circulating water pump in the water circuit system.

a) Specifications

1. Circuit board: Signals can be output from the I/O board that is standard-equipped in heat-source units.
2. Variable flow rate control signal output: 0V-10 VDC
 - ♦ Signal output settings can be changed with the Dip SW on the heat-source unit.
(Settings need to be changed to suit given specifications of the water control valve.)

Switch			Function	Operation according to the switch setting		Switch setting timing	Unit (Note 2)
				OFF (LED3: Unlit)	ON (LED3: Lit)		
SW4 1-10 [0: OFF; 1: ON] (Note 1) SW6-10: ON	No. 810	0101010011	Outputs circulating water flow rate control signal	0 V: Fully open 10 V: Fully closed [Default]	0 V: Fully closed 10 V: Fully open	After power on and while the compressor is stopped	C

(Note 1) To switch between the ON/OFF settings, first set SW6-10 to ON, then set SW4, and finally press and hold SWP1 for two seconds or longer to reflect the change.

LED3 will be lit when the switch is set to ON, and LED3 will be unlit when the switch is set to OFF.

Check the LED3 indicator status to make sure the setting is set as intended.

The switch needs to be re-set at the replacement of the control board.

Note the settings on the electrical wiring diagram label on the control box.

(Note 2) A: Requires the switch on OC to be set.

B: Requires the switches on both OC and OS to be set to the same setting.

C: Requires the switches on both OC and OS to be set.

D: Requires the switches on either OC or OS to be set.

- ♦ The amount of circulating water required for the heat-exchanger unit is calculated based on the operation status of the heat-exchanger, and signals are output in the range between 0 and 10 VDC. (See b)-1. for details.)

3. Power supply: 3~ 208/230/460 V ... for heat-source unit
24 VAC or 24 VDC ... for (motor-powered) water flow rate control valve
 - ♦ See Figure c)-1 and Table c)-1 for information on supplying power to water flow rate control system.
4. Inlet water temperature range: 10 to 45°C (-5 to 45°C when using brine)
 - ♦ The same temperature range applies regardless of the Enable/Disable setting status of the circulating water flow rate control function.
5. Water flow rate range: The table below summarizes the water flow rate ranges for heat-source units.

Model		Water flow rate range
P72-P120	7.5-12.5HP	3.0-7.2 m ³ /h (50-120 L/min)
P144-P192	15-20HP	4.5-11.6 m ³ /h (75-192 L/min)
P216-P240	22.5-25HP	6.0-14.4 m ³ /h (100-240 L/min)

- ♦ The same water flow rate range applies regardless of the Enable/Disable setting status of the circulating water flow rate control function.

6. Water-circuit components: To be procured on site
 - ♦ Water-circuit components that are necessary to control circulating water include such components as (motor-powered) water flow rate control valve, control valve, and shut-off valve. Valves that meet the water-flow-rate specification of the heat-source unit must be used.
 - ♦ See Figure c)-1 and Table c)-1 for information on the components in the circuit that is subject to circulating water flow rate control.
 - ♦ When a system includes multiple heat-source units, each unit requires a water flow rate control valve.
7. Electrical wiring: To be procured on site
 - ♦ See Figure c)-1 and Table c)-2 for information on supplying power to water flow rate control system.

b) Circulating water flow rate control signal output

1. Water flow rate control signal output

Signal to control the water flow rate control valve is calculated by using the circulating water flow rate required, which is calculated based on the operating status of the unit.

Table below shows the three signal output conditions.

Status	A	B-1	B-2	C
Condition	Unit at stoppage	All heat-source units (OC/OS) in Thermo-OFF		During compressor operation
		Dip SW4 (901) = ON	Dip SW4 (901) = OFF	
Dip SW4 (810) = OFF	10 V	10 V	5 V (Min. water flow rate)	5-0 V
Dip SW4 (810) = ON	0 V	0 V	7.6 V (Min. water flow rate)	7.6-9.1 V

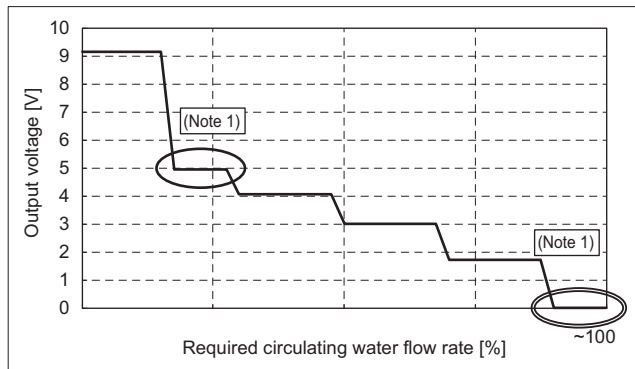

Figure b-1 Analog signal output (when Dip SW4 (810) is set to OFF)

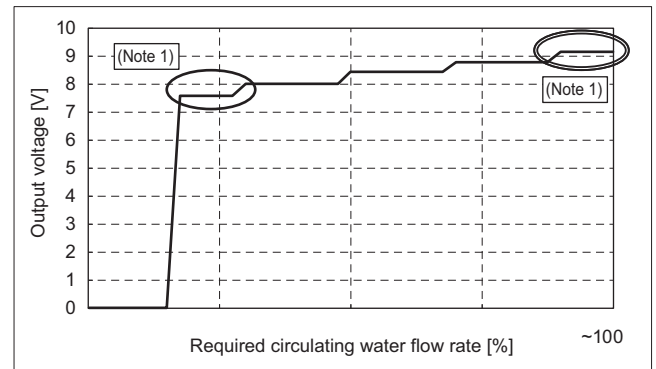

Figure b-2 Analog signal output (when Dip SW4 (810) is set to ON)

(Note 1) Output signals may deviate from the values shown in the tables by up to 10%.

During the test run, check that the flow rate of the circulating water supplied to the heat-source units falls within the operating range, even with the variations in output signals.

(Output voltage as indicated by a single circle: Greater than the minimum water flow rate; output voltage as indicated by double circles: Less than the maximum water flow rate)

(Note 2) To stabilize the heat-source unit operation, valve opening signal may temporarily exceeds the operating range.

(Note 3) It is recommended to use the type of water flow rate control valve that fully opens at 0 V and to set the Dip SW so that sufficient amount of circulating water will be supplied to the heat-source units even if the valve opening signal to the variable water flow control valve is lost.

(Note 4) When a system includes multiple heat-source units, each unit requires a water flow rate control valve that controls the circulating water flow rate.

2. Specifications of (motor-powered) water flow rate control valve

Note the following regarding (motor-powered) water flow rate control valve.

- 1) Select the valve capacity based on the range of circulating water supply to heat-source units and on the analog signal output range.
- 2) The types of valves with an inverting function (fully opens at 0 V) are recommended to ensure that sufficient amount of circulating water is supplied to the heat-source unit, even if the valve opening signal to the water flow rate control valve is lost.
- 3) It is recommended to use valves that allow for manual operation and for confirmation of present opening angle for easy test run and maintenance.

c) Schematic system diagram including heat-source units, water circuits, power supplies, and signals

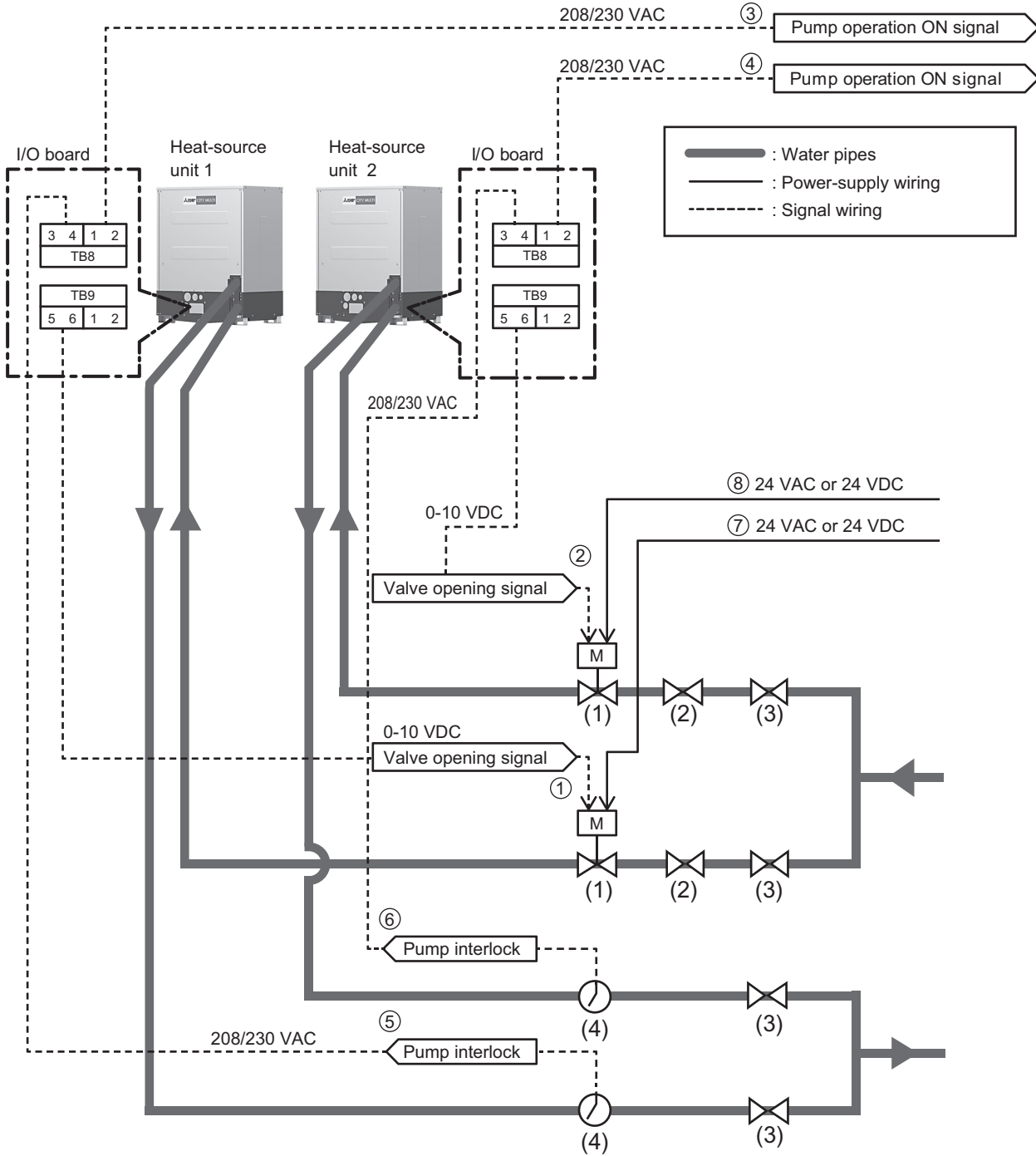

Figure c)-1 Schematic system diagram

Table c)-1 Water-circuit system

Symbol	Component	Usage	Note
(1)	(Motor-powered) water flow rate control valve	For controlling water flow rate	To be procured on site (See b)-2.)
(2)	Control valve	For keeping the circulating water flow rate within the operating range	To be procured on site
(3)	Shut-off valve	For the maintenance of devices	To be procured on site
(4)	Flow switch	For detecting the lower limit of circulating water flow rate	To be procured on site

Table c)-2 Electrical wiring specification

Symbol	Component	Specification	Connection example	Note
①	Command to adjust valve opening (Unit 1)	0 to 10 VDC	Unit 1 (TB9-5, 6) -Water flow rate control valve 1	Analog output
②	Command to adjust valve opening (Unit 2)	0 to 10 VDC	Unit 2 (TB9-5, 6) -Water flow rate control valve 2	Analog output
③	Pump operation ON signal (Unit 1)	208/230 VAC	Unit 1 (TB8-1, 2) - Control board	Digital output
④	Pump operation ON signal (Unit 2)	208/230 VAC	Unit 2 (TB8-1, 2) - Control board	Digital output
⑤	Pump interlock (Unit 1)	208/230 VAC	Flow switch - Unit 1 (TB8-3, 4)	Digital input
⑥	Pump interlock (Unit 2)	208/230 VAC	Flow switch - Unit 2 (TB8-3, 4)	Digital input
⑦	Power supply for water flow rate control valve (Unit 1)	24 VAC or 24 VDC	Control board - Water flow rate control valve 1	Power supply
⑧	Power supply for water flow rate control valve (Unit 2)	24 VAC or 24 VDC	Control board - Water flow rate control valve 2	Power supply

PQRY-P-T(S)LMU-A1, Y(S)LMU-A1

d) Electrical wiring diagram of heat-source unit
 Terminal blocks TB8 and TB9 for controlling water flow rate are found on the I/O board.
 Wiring connections need to be made for each heat-source unit.

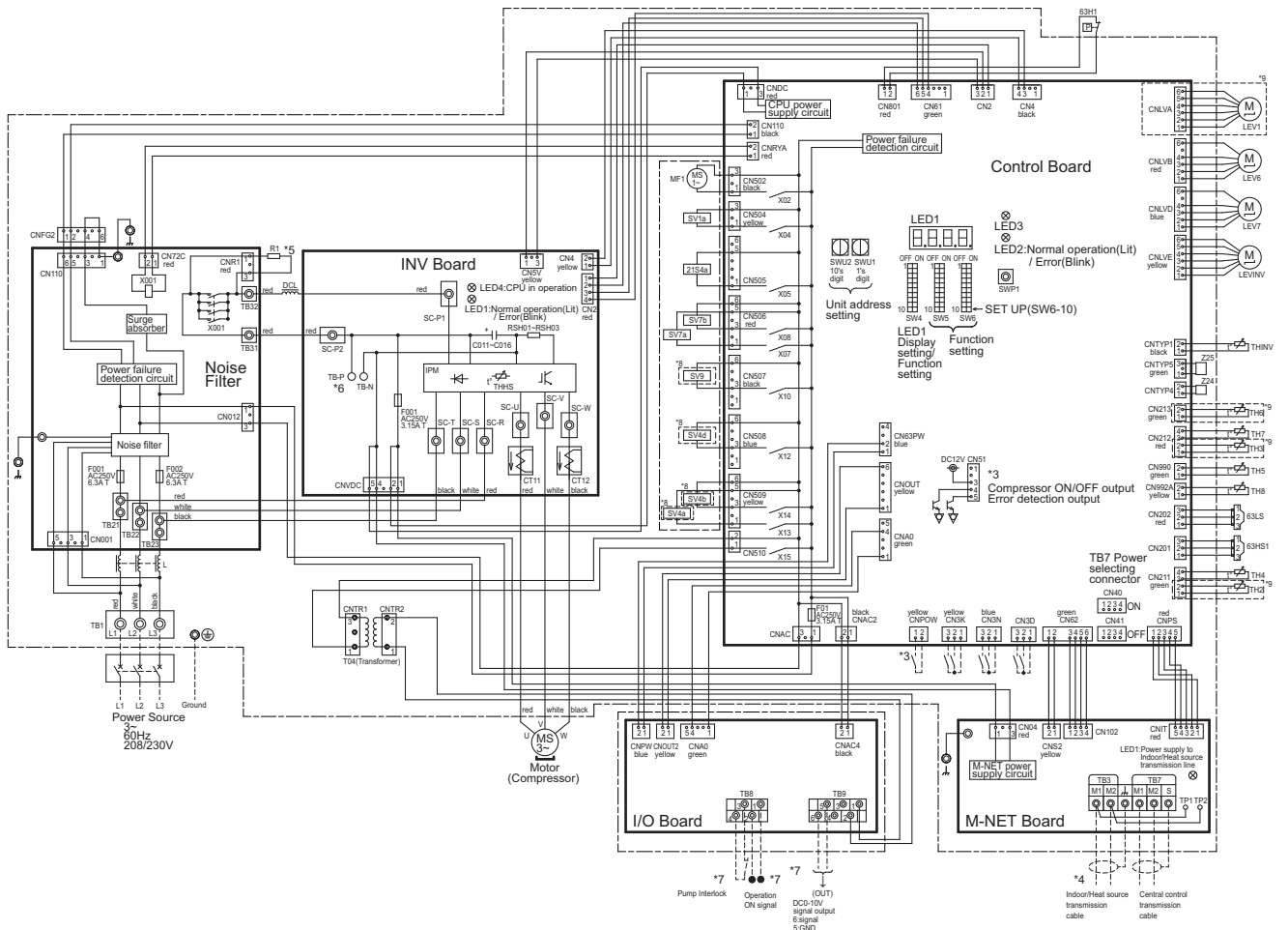

Figure d)-1 Electrical wiring diagram of heat-source unit

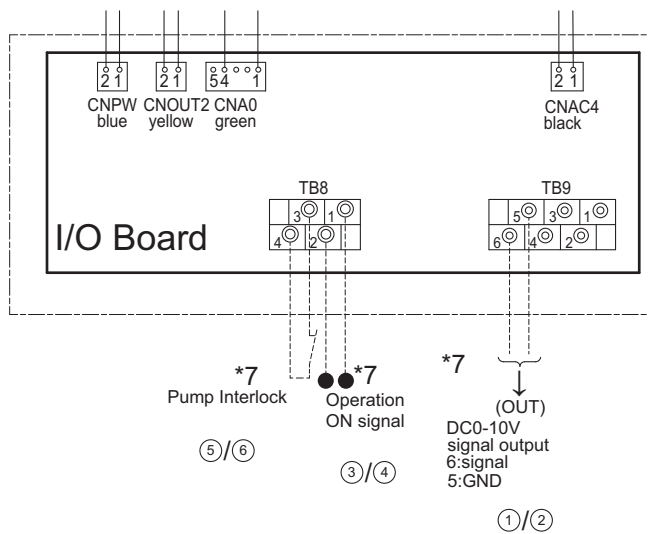

Figure d)-2 I/O board wiring diagram

(Note 1) Use insulated terminals for connection to TB8 and TB9.

PQRV-P-T(S)LMU-A1, Y(S)LMU-A1

e) Installation

Note the following for installing the circulating water flow rate control system.

1. Make sure that water circuit components necessary to build a circulating water flow rate control system are in place.
 - ♦ See Figure c)-1 and Table c)-1.
 - ♦ When a system includes multiple heat-source units, each unit requires a water flow rate control valve.
2. Connect all wirings (power-supply, signal, etc.) required by the circulating water flow rate control system.
 - ♦ See Figure c)-1 and Table c)-2.
3. Check the circulating water flow rate control system (including the heat-source unit) for proper operation.
4. Check that the circulating water supplied to the heat-source unit is within the operating range.
 - ♦ Make sure the inlet water temperature is within the operating range.
 - ♦ Make sure the water strainer is not clogged.
 - ♦ Make sure the circulating water flow rate is within the operating range in both the single-heat-source-unit systems or in the multiple-heat-source-unit systems and both during Thermo-OFF and in operation.
 - ♦ When using a single pump for multiple heat-source units in multiple systems, make sure that the flow rate of the circulating water supplied to each unit is within the operating range regardless of the ON/OFF status of the heat-source units in the system.
 - ♦ To check for proper operation of water flow rate control valve and to check that the circulating water flow rate is within the operating range, the use of device that outputs a voltage between 0 VDC and 10 VDC is recommended.
5. Check the system for the following items to use the circulating water control system in the normal operating range.
 - ♦ Management of supply water flow rate that takes strainer clogging and other possible problems that can occur during operation into consideration.
 - ♦ Adjustment of water-quality during operation
 - ♦ Measures against possible problems with the water-circuit system
(Examples: Water outage, circulating water flow rate outside the specification range, clogged strainer, air in the circulation system, water pump failure, water flow rate control valve problem, pump interlock failure, etc.)

f) Expansion function for the management of circulating water flow rate

Making the following settings can reduce the power required to operate the circulating water pump in the water circuit system. (Note that doing so may delay the start of heat-source units by a few minutes.)

Switch			Function	Operation according to the switch setting		Switch setting timing	Unit (Note 2)
				OFF (LED3: Unlit)	ON (LED3: Lit)		
SW4 1-10 [0: OFF; 1: ON] (Note 1) SW6-10: ON	No. 901	1010000111	Changes signal output when all heat-source units (OC/OS) go into Thermo-OFF	Water flow rate control valve remains open when all heat-source units (OC/OS) go into Thermo-OFF. (Minimum water flow rate) [Default]	Water flow rate control valves will close when all heat-source units (OC/OS) go into Thermo-OFF.	After power on and while the compressor is stopped	C
SW4 1-10 [0: OFF; 1: ON] (Note 1) SW6-10: ON	No. 917	1010100111	Pump operation ON signal	Signals are output when heat-source units go into Thermo-OFF. [Default]	Signals are output when Cooling/Heating operation signals are received from the controller.	After power on and while the compressor is stopped	C

(Note 1) To switch between the ON/OFF settings, first set SW6-10 to ON, then set SW4, and finally press and hold SWP1 for two seconds or longer to reflect the change.

LED3 will be lit when the switch is set to ON, and LED3 will be unlit when the switch is set to OFF.

Check the LED3 indicator status to make sure the setting is set as intended.

The switch needs to be re-set at the replacement of the control board.

Note the settings on the electrical wiring diagram label on the control box.

(Note 2) A: Requires the switch on OC to be set.

B: Requires the switches on both OC and OS to be set to the same setting.

C: Requires the switches on both OC and OS to be set.

D: Requires the switches on either OC or OS to be set.

(Note 3) To use the functions above, be sure to set the switches in the following combinations.

· Set SW4 (901) to OFF and SW4 (917) to ON to keep the pumps on all heat-source units (OC/OS) to operate during Thermo-OFF and to keep the water flow rate control valve open.

· Set SW4 (901) to ON and SW4 (917) to OFF to stop the pumps on all heat-source units (OC/OS) during Thermo-OFF and to close the water flow rate control valve.

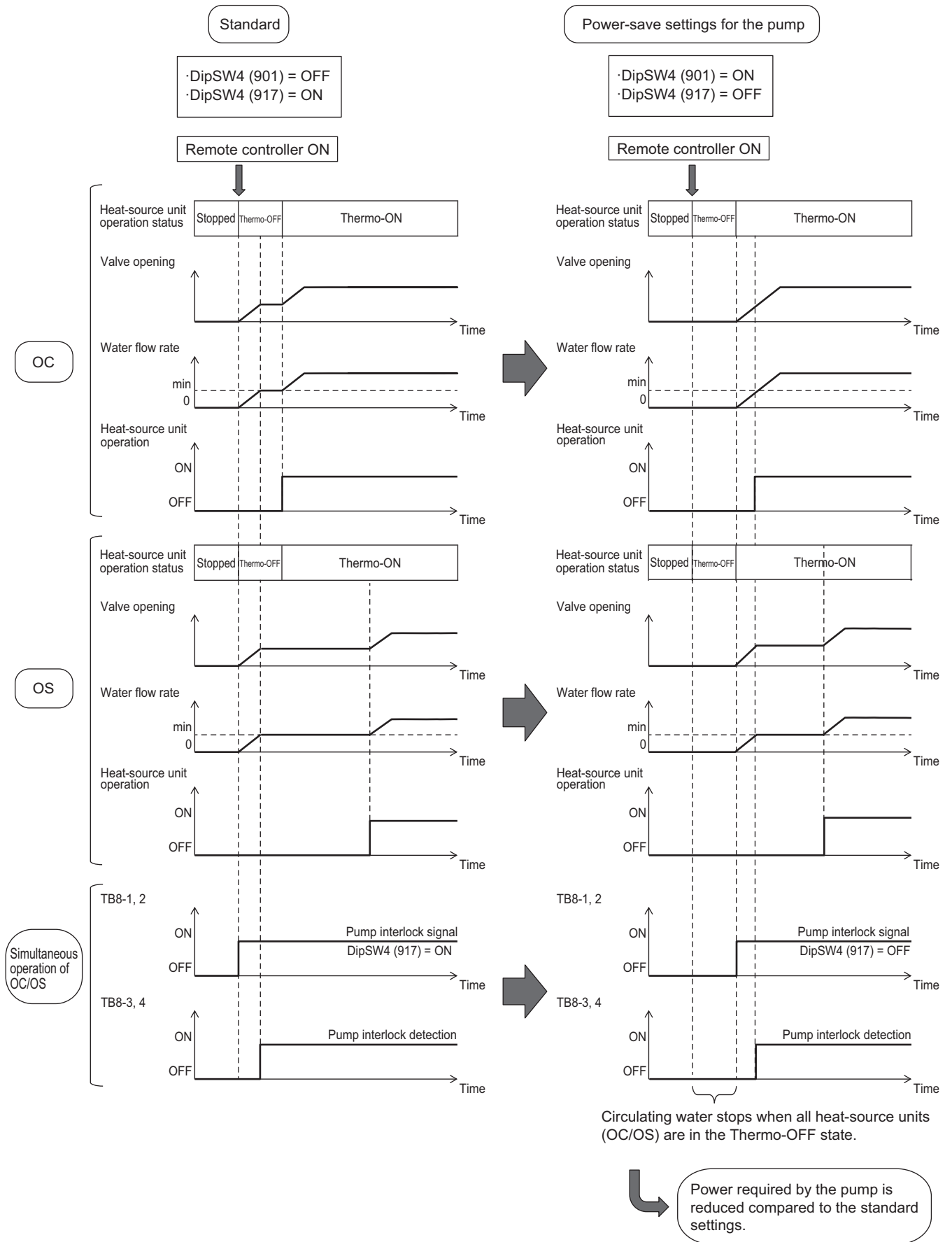

PQRY-P-T(S)LMU-A1, Y(S)LMU-A1

8-2. Water piping work

Although the water piping for the CITY MULTI WR2 system does not differ from that for ordinary air conditioning systems, pay special attention to the items below in conducting the piping work.

1) Items to be observed on installation work

- The water pressure resistance of the water pipes in the heat source unit is 2.0MPa [290psi].
- In order to equalize piping resistance for each unit, adapt the reverse return system.
- Mount a joint and a valve onto the water outlet/inlet of the unit to allow for maintenance, inspection and replacement work. Be sure to mount a strainer at the water inlet piping of the unit. (The strainer is required at the circulation water inlet to protect the heat source unit.)
- * The installation example of the heat source unit is shown right.
- Be sure to provide an air relief opening on the water piping properly, and purge air after feeding water to the piping system.
- Condensate will generate at the low temperature part inside the heat source equipment. Connect drain piping to the drain piping connection located at the bottom of the heat source equipment.
- Mount a backflow prevention valve and a flexible joint for vibration control onto the pump.
- Provide a sleeve to the penetrating parts of the wall to prevent the piping.
- Fasten the piping with metal fitting, arrange the piping not to expose to cutting or bending force, and pay sufficient care for possible vibration.
- Be careful not to erroneously judge the position of the inlet and outlet of water.
(Lower position : Inlet, Upper position : Outlet)
- When connecting heat source unit water piping and water piping on site, apply liquid sealing material for water piping over the sealing tape before connection.
- This unit doesn't include a heater to prevent freezing within tubes. If the water flow is stopped on low ambient, drain the water out.
- The unused knockout holes should be closed and the refrigerant pipes, water pipes, power source and transmission wires access holes should be filled with putty.
- The drain plug is installed on the back of the unit at factory for field-connection of the drain pipes on the front of the unit. Move the plug to the front to connect the drain pipes on the back. Verify that there are no leaks from pipe connections.
- For installing two units, install water pipes in parallel to each other so that the water flow rate through both units will be equal.
- Wrap the sealing tape as follows.
 - a) Wrap the joint with sealing tape in the direction of the threads (clockwise), and do not let the tape run over the edge.
 - b) Overlap the sealing tape by two-thirds to three-fourths of its width on each turn. Press the tape with your fingers so that it is pressed firmly against each thread.
 - c) Leave the 1.5th through 2nd farthest threads away from the pipe end unwrapped.
- Hold the pipe on the unit side in place with a spanner when installing the pipes or strainer. Tighten screws to a torque of 150N·m.
- Consider the circulating-water temperature and the water pressure range when deciding on the piping specifications.

2) Thermal insulation work

Thermal insulation or anti sweating work is not required for the piping inside buildings in the case of the CITY MULTI WR2 system if the operating temperature range of inlet water stays within the temperature near the normal (summer : 30°C[86°F], winter : 20°C[68°F]).

- In case of the conditions below, however, thermal insulation is required.
- Use of well water for heat source water
- Outdoor piping portions
- Indoor piping portions where freezing may be caused in winter
- A place where vapor condensation may be generated on piping due to an increase in dry bulb temperature inside the ceiling

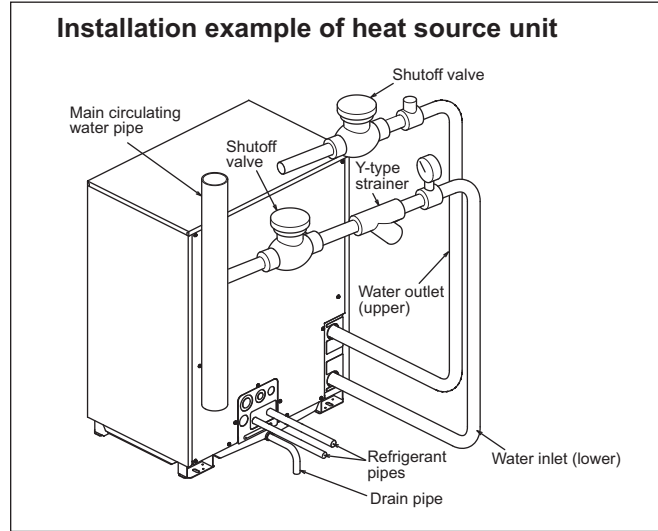

- caused by the entry of fresh outdoor air
- Drain piping portions

3) Water treatment and water quality control

To preserve water quality, use the closed type of cooling tower for WY/WR2. In the case that an open type cooling tower is employed or the circulating water quality is inferior, scale will adhere onto the water heat exchanger leading to the decreased heat exchange capacity or the corrosion of the heat exchanger. Be sufficiently careful for water quality control and water treatment at the installation of the circulation water system

- Removal of impurities inside piping
Be careful not to allow impurities such as welding fragment, remaining sealing material and rust from mixing into the piping during installation work.
- Water treatment
The water quality standards have been established by the industry (Japan Refrigeration, Air Conditioning Industry Association, in case of Japan) for water treatment to be applied.

Items	Lower mid-range temperature water system		Tendency	
	Recirculating water [20<T<60°C] [68<T<140°F]	Make-up water	Corrosive	Scale-forming
pH (25°C[77°F])	7.0 ~ 8.0	7.0 ~ 8.0	○	○
Electric conductivity (mS/m) (25°C[77°F])	30 or less	30 or less	○	○
(μS/cm) (25°C[77°F])	[300 or less]	[300 or less]		
Chloride ion (mg Cl/l)	50 or less	50 or less	○	
Sulfate ion (mg SO ₄ ²⁻ /l)	50 or less	50 or less	○	
Acid consumption (pH4.8) (mg CaCO ₃ /l)	50 or less	50 or less		○
Total hardness (mg CaCO ₃ /l)	70 or less	70 or less		○
Calcium hardness (mg CaCO ₃ /l)	50 or less	50 or less		○
Ionic silica (mg SiO ₂ /l)	30 or less	30 or less		○
Iron (mg Fe/l)	1.0 or less	0.3 or less	○	○
Copper (mg Cu/l)	1.0 or less	0.1 or less	○	
Sulfide ion (mg S ²⁻ /l)	not to be detected	not to be detected	○	
Ammonium ion (mg NH ₄ ⁺ /l)	0.3 or less	0.1 or less	○	
Residual chlorine (mg Cl/l)	0.25 or less	0.3 or less	○	
Free carbon dioxide (mg CO ₂ /l)	0.4 or less	0.4 or less	○	
Ryzner stability index	-	-	○	○

Reference : Guideline of Water Quality for Refrigeration and Air Conditioning Equipment. (JRA GL02E-1994)

In order to keep the water quality within such standards, you are kindly requested to conduct bleeding-off by overflow and periodical water quality tests, and use inhibitors to suppress condensation or corrosion. Since piping may be corroded by some kinds of inhibitor, consult an appropriate water treatment expert for proper water treatment.

4) Pump interlock

Operating the heat source unit without circulation water inside the water piping can cause a trouble. Be sure to provide interlocking for the unit operation and water circuit. Since the terminal block is being provided inside the unit, use it as required.

5) Handling plate heat exchangers for heat-source units

<Designing the piping system>

- Install a strainer (50 mesh or finer recommended) near the heat-source unit on the inlet side of the hot/cold water pipe and cooling-water pipe (hereafter referred to as water pipes) to prevent an infiltration of foreign materials of solid nature, such as dirt and sand, into the plate heat exchanger.
- Depending on the water quality, scale may form inside plate heat exchangers. Plate heat exchangers must be chemically cleaned regularly to remove scale formation. Install sluice valves on the water pipes, and provide ports for connecting a pipe between the sluice valves and the heat-source unit for chemical cleaning.
- On both the inlet and outlet sides of water pipes, provide a plug to remove trapped air and water (also to be used for cleaning heat-source units and for purging water before a period of nonuse in winter or at the end of an air conditioning season). Also, provide automatic air-vent valves where air is likely to be trapped (such as a pipe that runs vertically).
- In addition to installing the above-mentioned strainers, install a cleanable strainer near the pump pipe inlet.
- Keep the pipes properly insulated and take an appropriate measure against humidity to minimize heat loss and prevent freeze damage in severe cold climate.
- If the system is stopped during winter or at night in subfreezing temperatures, take appropriate measures to protect pipes from freezing (i.e., pipe purging and use of water-circulation pump or heater) and prevent resultant damage to the plate heat exchanger.

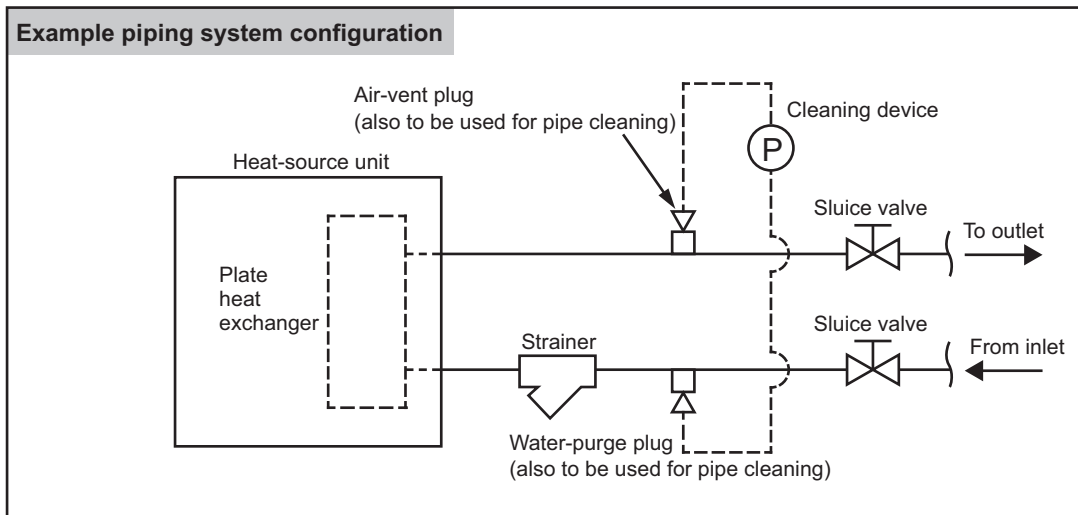

<Test run>

- Before performing a test run, check that the piping system is properly installed, especially the strainers, air-vents, automatic water-supply valves, expansion tanks, and systems.
- After the pipe system is filled with water, first, operate the pump alone to check the system for trapped air and adjust the water flow rate to prevent the plate heat exchanger from freezing. Take into consideration the water pressure loss before and after each heat-source unit, and make sure the water flow rate falls within the design water flow rate range. Stop the test run and correct any problems found, if any.
- At the completion of a test run, check the strainer at the inlet pipe of the heat-source unit and clean it as necessary.

<Daily maintenance>

- Controlling the water quality
Plate heat exchangers cannot be disassembled for cleaning and have no replaceable parts. Watch the water quality to prevent corrosion and scale formation. The quality of the water to be used for plate heat exchangers must meet the water quality guidelines JRA GL-02-1994 specified by Japan Refrigeration and Air conditioning Industry Association (JRAIA). (Refer to 3) Water treatment and water quality control.)
- Controlling the circulation water flow rate
Insufficient water rate will cause freeze damage to plate heat exchangers. Check for insufficient water flow caused by clogged strainer, trapped air in the system, or malfunction of the circulation water pump. Flow rate can also be checked by measuring the temperature or pressure difference between the inlet and outlet of plate heat exchangers. If the temperature or pressure difference goes outside of the specified range, stop the operation, remove the cause of the problem, and resume operation.
- What to do when the freeze protection trips
If the freeze protection trips during operation, be sure to remove its cause before resuming operation. Tripped freeze protection indicates that the system is partially frozen, and resuming operation without removing the cause of the problem will result in freeze damage to plate heat exchangers and/or pipes as well as resultant refrigerant leaks and infiltration of water into the refrigerant circuit.

<Maintaining plate heat exchangers>

Plate heat exchangers must be maintained in a planned and periodical manner to prevent scale formation, which may cause performance loss or decrease water flow rate that result in freeze damage to the plate heat exchanger.

- ♦ Check the following items before the operating season.
 1. Check that the water quality meets the specified water quality.
 2. Clean the strainers.
 3. Check that the water flow rate is adequate.
 4. Check for proper operation (e.g., pressure, flow rate, inlet/outlet temperatures).
- ♦ Plate heat exchangers cannot be disassembled for cleaning. Clean them in the following way.
 1. Make sure that there is a pipe connection port on the water inlet pipe.
Use formic acid, citric acid, oxalic acid, acetic acid, or phosphoric acid diluted to 5% to clean plate heat exchangers. Do not use highly corrosive acids, such as hydrochloric acid, sulfuric acid, or nitric acid.
 2. Make sure that valves are installed before the inlet connection port and after the outlet connection port.
 3. Connect a pipe for circulating cleaning solution to the inlet/outlet pipes of the plate heat exchanger, fill the plate heat exchanger with cleaning solution at a temperature between 50 and 60°C, and circulate the cleaning solution with a pump for 2 to 5 hours. The cleaning time will depend on the temperature of the cleaning solution and the degree of scale formation. Use the color of the cleaning solution as a guide to determine how long the system needs to be cleaned.
 4. When done, discharge the cleaning solution out of the plate heat exchanger, fill it with sodium hydrate (NaOH) or sodium bicarbonate (NaHCO₃) diluted with water to 1 to 2%, and let the solution be circulated for 15 to 20 minutes until the cleaning solution is neutralized.
 5. After neutralizing the cleaning solution, thoroughly rinse the plate heat exchanger with clean water.
 6. When using a commercially available cleaning solution, make sure to use a solution not corrosive to stainless steel or copper.
 7. Consult the cleaning solution manufacture for details.
- ♦ At the completion of cleaning, check the system for proper operation.

9-1. JOINT and REDUCER

CITY MULTI units can be easily connected by using Joint sets and Reducer sets provided by Mitsubishi Electric. Refer to section "Piping Design" or the Installation Manual that comes with the Joint set or Reducer set for how to install the Joint set or Reducer set.

PQR-Y-P-T(S)LMU-A1, Y(S)LMU-A1

CMY-Y102SS-G2

in.

For Gas pipe:

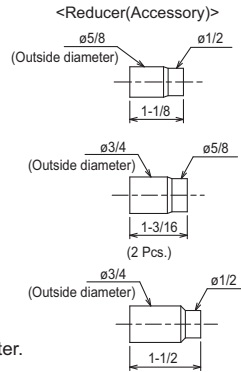
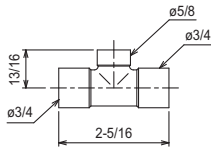

For Liquid pipe:

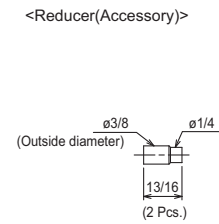
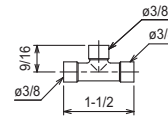

*Pipe diameter is indicated by inside diameter.

CMY-Y102LS-G2

in.

For Gas pipe:

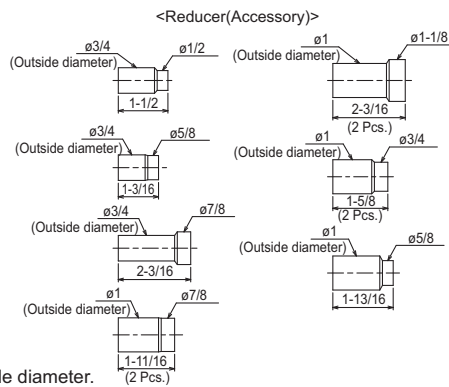
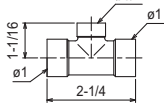

For Liquid pipe:

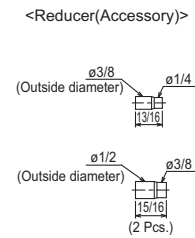
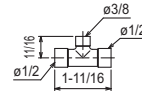

*Pipe diameter is indicated by inside diameter.

in.

in.

in.

in.

in.

CMY-R201S-G

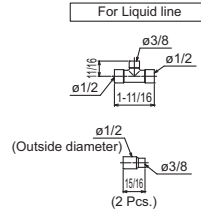
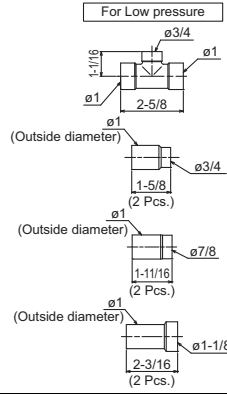
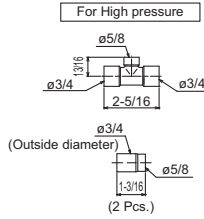

<Accessory>
 • Cover 3 Pcs.
 Note. Pipe diameter is indicated by inside diameter.

CMY-R202S-G

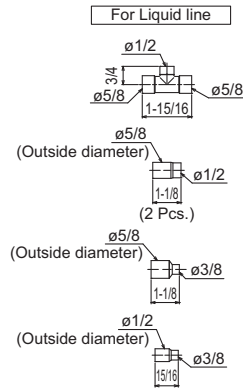
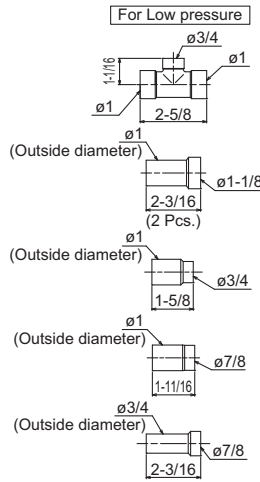
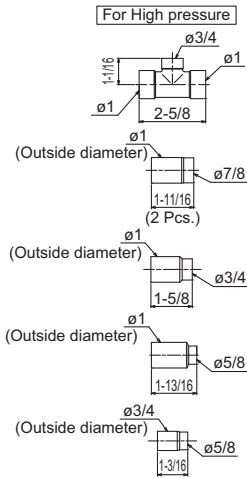

<Accessory>
 • Cover 3 Pcs.
 Note. Pipe diameter is indicated by inside diameter.

CMY-R203S-G

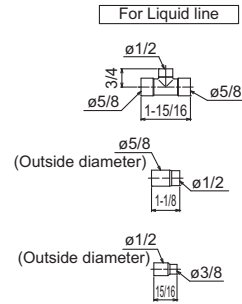
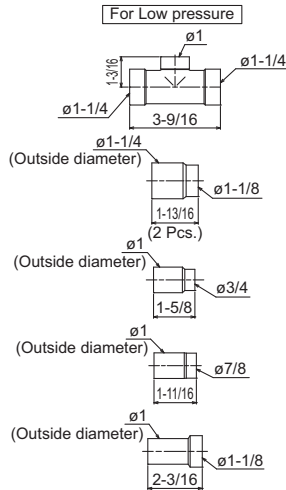
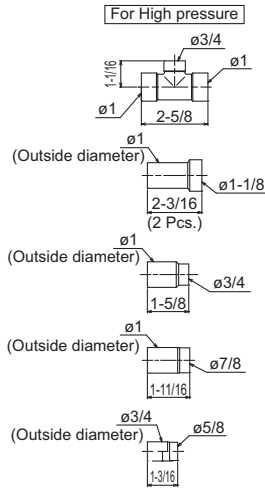

<Accessory>
 • Cover 3 Pcs.
 Note. Pipe diameter is indicated by inside diameter.

PQRY-P-T(S)LMU-A1, Y(S)LMU-A1

CMY-R204S-G

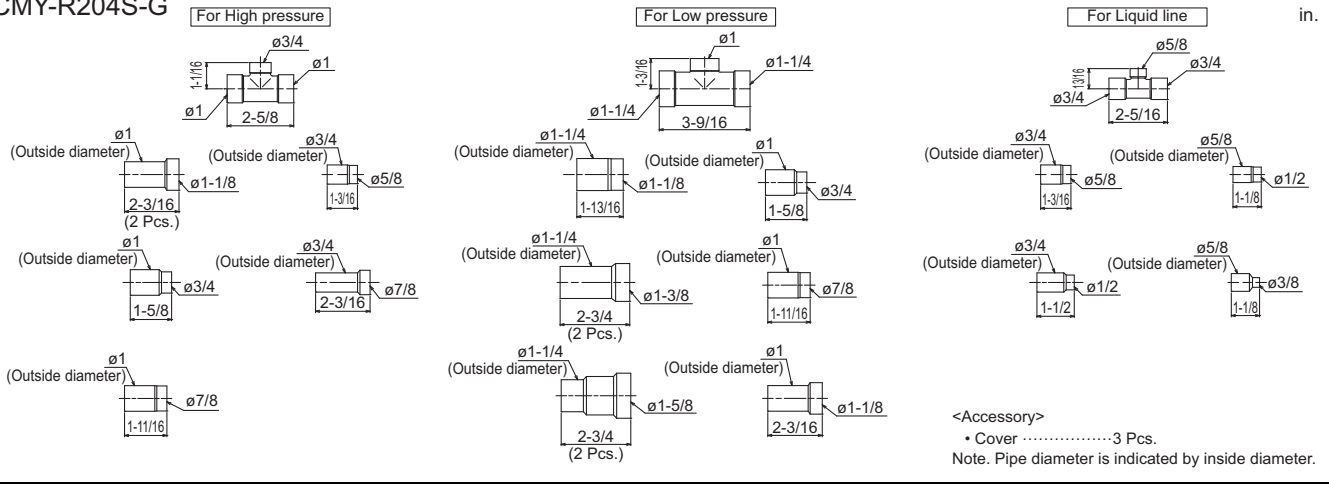

CMY-R205S-G

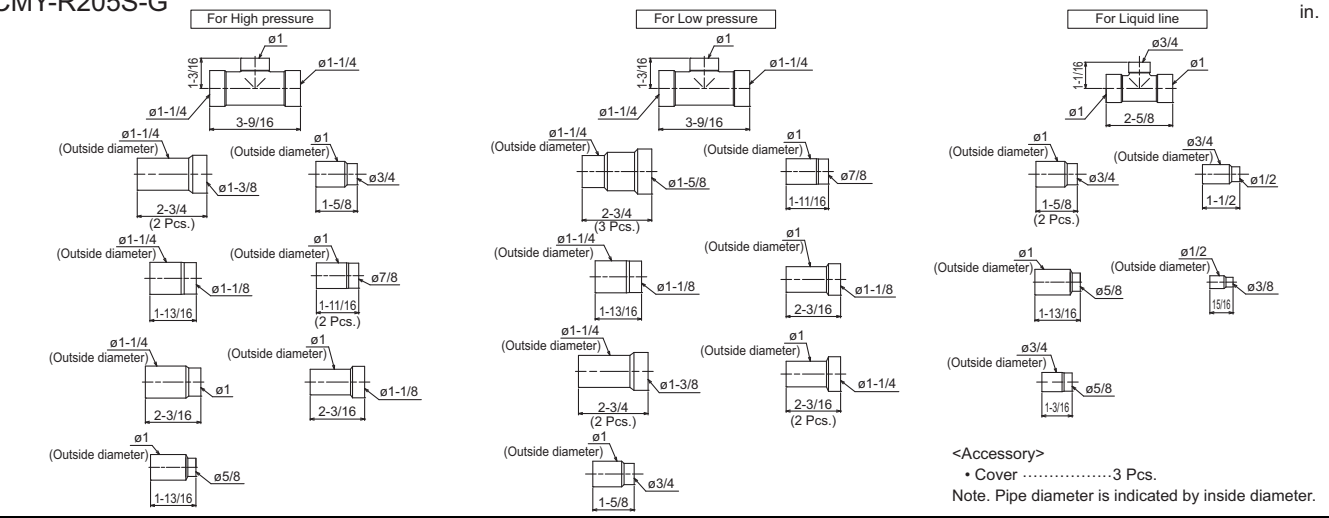

CMY-R301S-G

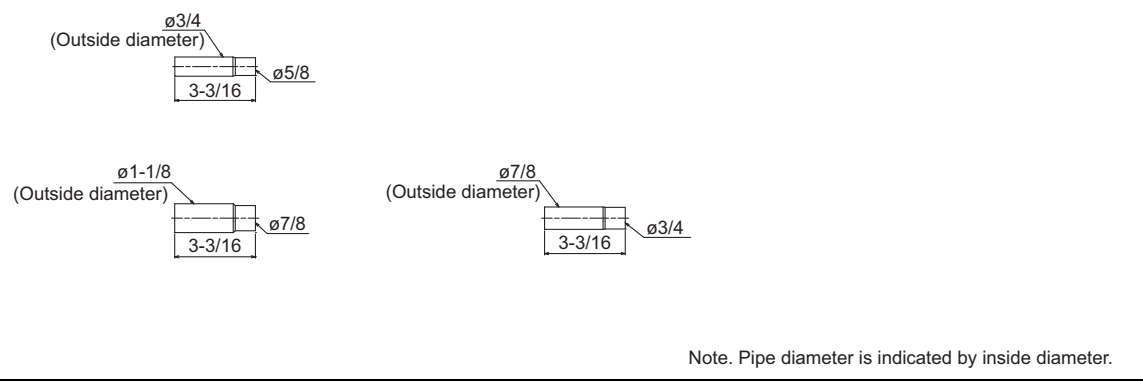

CMY-R302S-G1

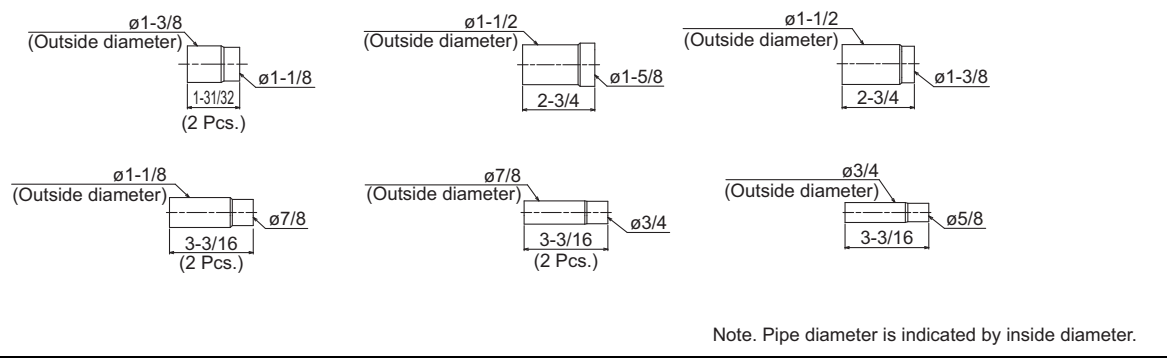

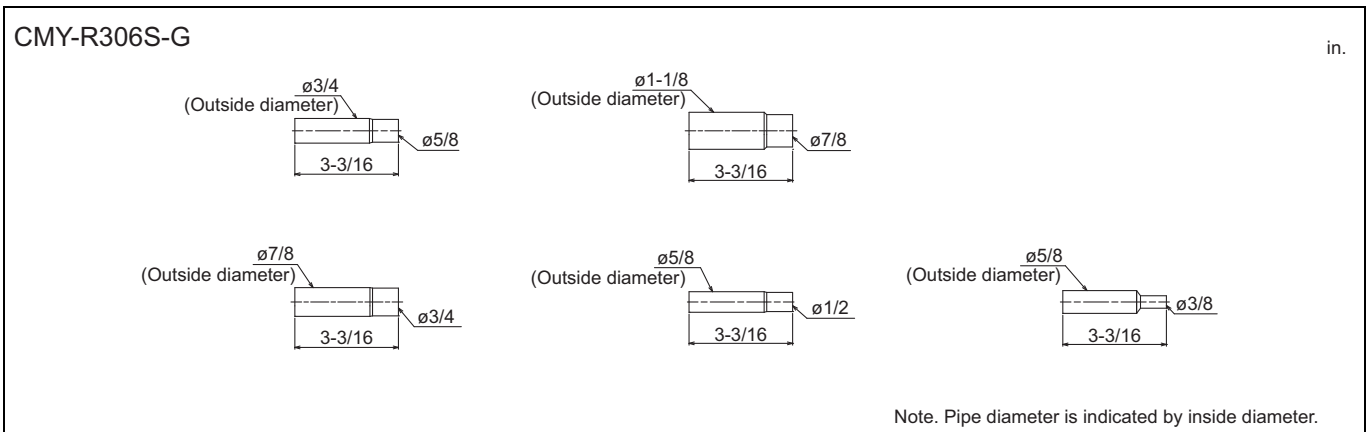
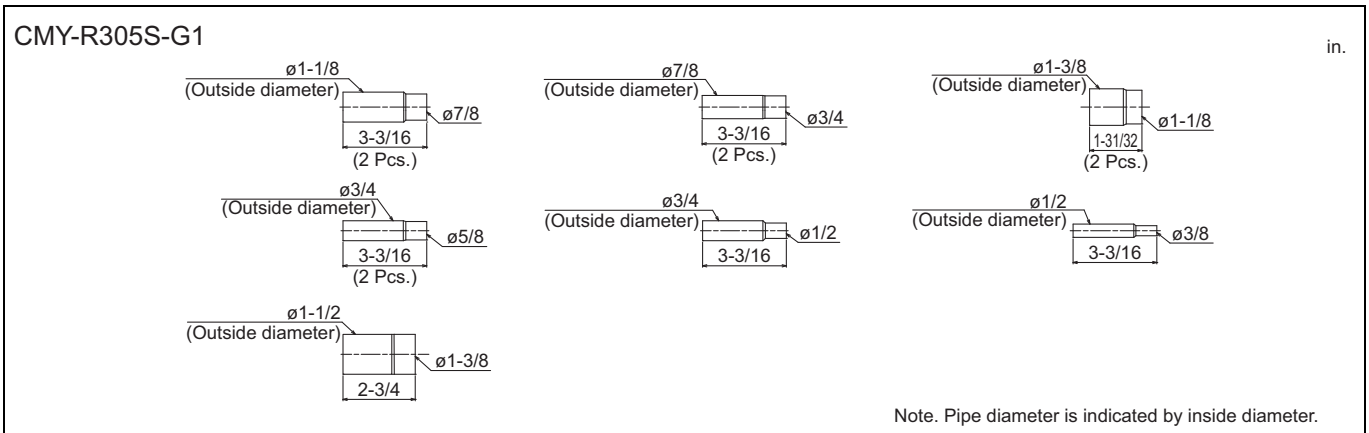
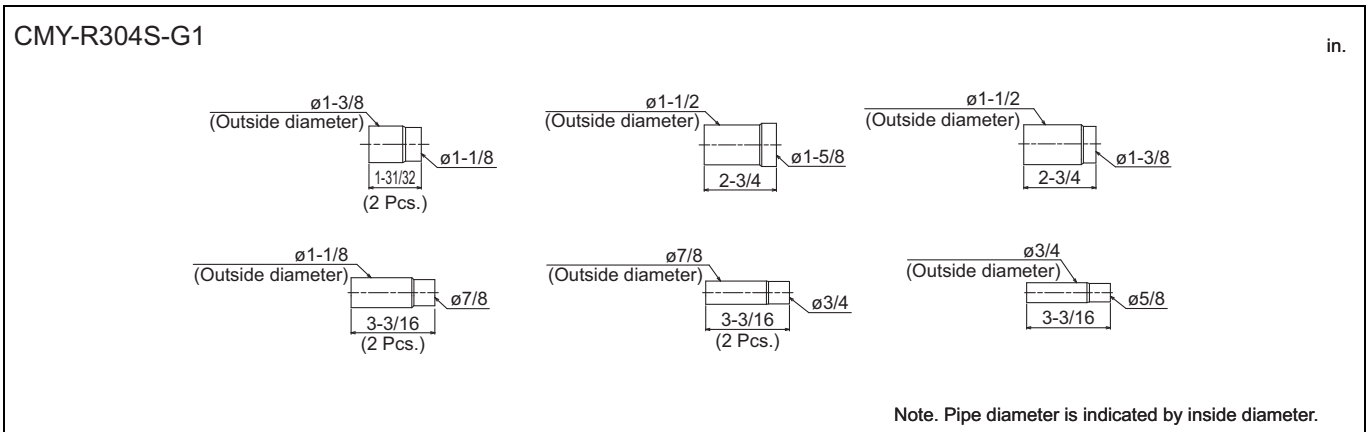
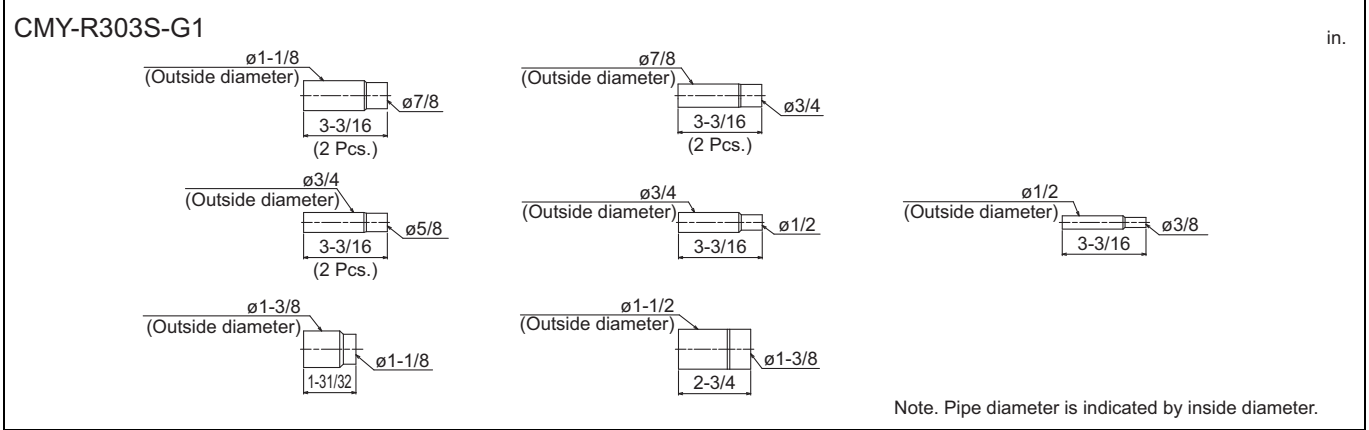

9-2. OUTDOOR TWINNING KIT

The following optional Outdoor Twinning Kit is needed to use to combine multiple refrigerant pipes. Refer to section "Piping Design" for the details of selecting a proper twinning kit.

PQR-Y-P-T(S)LMU-A1, Y(S)LMU-A1

CMY-Q100CBK2

Low-pressure pipe twinning kit

<Elbow pipe(Accessory)>

<Accessory>

Fixing screw	***1
Insulation cover	***1
Pipe cover (150mm(5-15/16) Length)	***2
Pipe cover (60mm(2-3/8) Length)	***1
Pipe cover (80mm(3-3/16) Length)	***2
Cable tie	***2
Water stopper	***1
Sealing material (Small)	***1
Sealing material (Large)	***1

High-pressure twinning pipe

<Pipe for routing through the front (Accessory)>

Note 1. Refer to the figure below for the installation position of the high-pressure twinning pipe.

Inclination tolerance of the high-pressure twinning pipe is $\pm 15^\circ$ relative to the ground.

2. Pipe diameter is indicated by inside diameter.

CMY-Q200CBK

Low-pressure pipe twinning kit

<Elbow pipe(Accessory)>

<Accessory>

Fixing screw	***1
Insulation cover	***1
Pipe cover (75mm(3) Length)	***1
Pipe cover (360mm(14-3/16) Length)	***1
Pipe cover (70mm(2-13/16) Length)	***1
Pipe cover (130mm(5-1/8) Length)	***1
Pipe cover (100mm(3-15/16) Length)	***1
Pipe cover (160mm(6-5/16) Length)	***1
Cable tie	***2
Water stopper	***1
Sealing material (Small)	***1
Sealing material (Large)	***1

High-pressure twinning pipe

<Deformed pipe(Accessory)>

<Pipe for routing through the front (Accessory)>

Note 1. Refer to the figure below for the installation position of the high-pressure twinning pipe.

Inclination tolerance of the high-pressure twinning pipe is $\pm 15^\circ$ relative to the ground.

2. Pipe diameter is indicated by inside diameter.

Note 1. Reference the attitude angle of the twinning pipe below the fig.

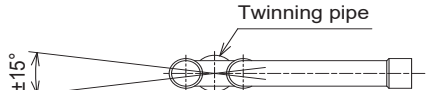

The angle of the twinning pipe is within $\pm 15^\circ$ against the horizontal plane.

2. Use the attached pipe to braze the port-opening of the twinning pipe.
3. Pipe diameter is indicated by inside diameter.

9-3. JOINT KIT "CMY-R160-J1" FOR BC CONTROLLER

Joint kit "CMY-R160-J1" for BC controller is used to combine 2 ports of the BC controller at a PURY/PQRY system so as to enable down-stream Indoor capacity above P54 as shown in Fig. 1.

The Joint kit include following items:

① Instruction	② Joint pipe(Small)	③ Joint pipe(Large)	④ Cover 1	⑤ Cover 2	⑥ Cover 3	⑦ Band	⑧ Reducer 1	⑨ Reducer 2
This sheet 1pc	1pc	1pc	2pcs	1pc for gas side	1pc for liquid side	8pcs	OD19.05-ID22.2 1pc	OD19.05-ID15.88 1pc

Please prepare the following items in the field. ①Tape for insulation material sealing ②Extension pipe for refrigerant circuit

② Joint pipe (for liquid side)

③ Joint pipe (for gas side)

mm (in.)

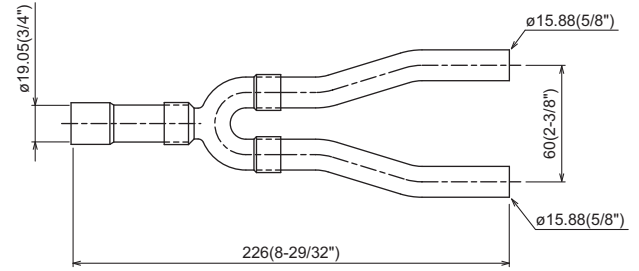
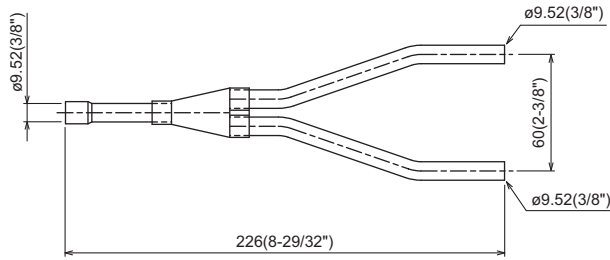

1. Designing CMY-R160-J1 to a PURY/PQRY system

The maximum down-stream Indoor capacity for 1 port of BC controller is P54. When the down-stream Indoor capacity is above P54, Joint kit CMY-R160-J1 is needed to combined 2 ports of BC controller to enlarge the capacity, like Group 2 and 3 in Fig. 1.

Maximum 3 Indoor units are allowed to connect to 1 port of BC controller or 2 combined ports of BC controller using CMY-R160-J1.

When connecting Indoor units to 1 port of BC controller or 2 combined ports of BC controller using CMY-R160-J1 or CMY-Y102SS-G2 is applicable, like Group 1 and 2 in Fig. 1

Caution: Mixed cooling and heating mode at the same time for Indoor units connecting to 1 port or 2 combined ports is not available.

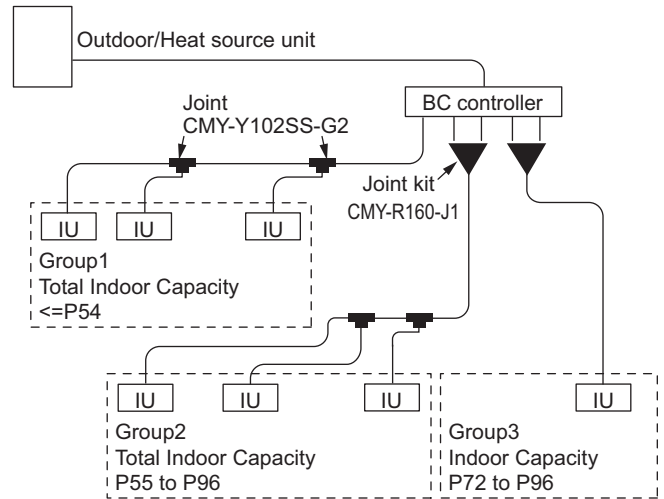

Fig.1. CMY-R160-J1 applying scheme

2. Piping at the installation site

The connection of CMY-R160-J1 to BC controller and pipe leading to Indoor units is referable to Fig. 2. Non-oxidized brazing is necessary. All piping must be careful to avoid foreign material getting inside.

After piping and air-tight testing, insulation work to the Joint and pipe should be done. Details is available at the Installation Manual.

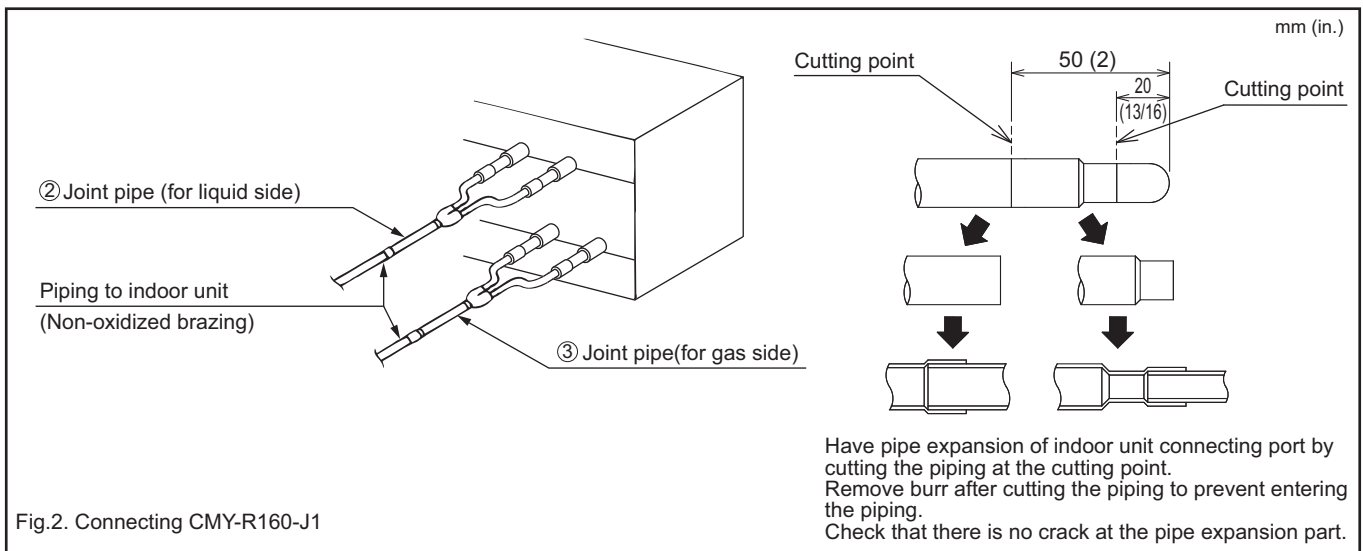
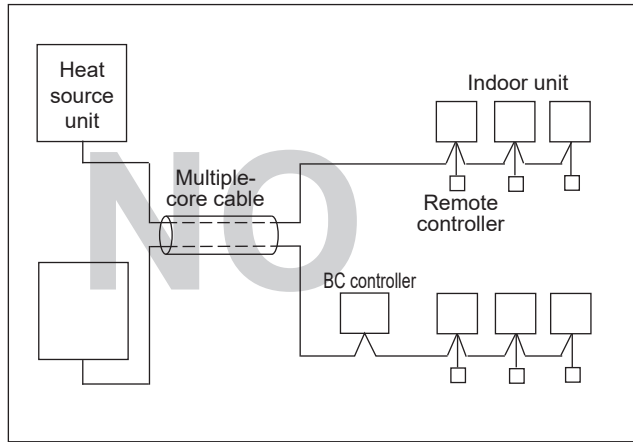
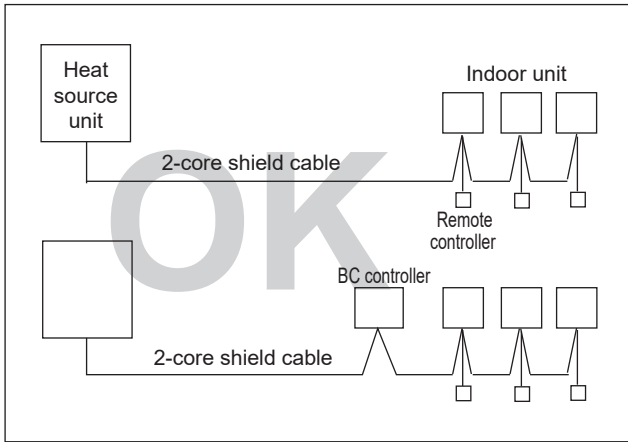

Fig.2. Connecting CMY-R160-J1

10-1. General cautions

- ① Follow ordinance of your governmental organization for technical standard related to electrical equipment, wiring regulations, and guidance of each electric power company.
- ② Wiring for control (hereinafter referred to as transmission cable) shall be (50mm[1-5/8in] or more) apart from power source wiring so that it is not influenced by electric noise from power source wiring. (Do not insert transmission cable and power source wire in the same conduit.)
- ③ Be sure to provide designated grounding work to heat source unit.
- ④ Give some allowance to wiring for electrical part box of indoor and heat source unit, because the box is sometimes removed at the time of service work.
- ⑤ Never connect 100V, 208~230V, 460V power source to terminal block of transmission cable. If connected, electrical parts will be damaged.
- ⑥ Use 2-core shield cable for transmission cable. If transmission cables of different systems are wired with the same multiple-core cable, the resultant poor transmitting and receiving will cause erroneous operations.
- ⑦ When extending the transmission line, make sure to extend the shield cable as well.

PQRY-P-T(S)LMU-A1, Y(S)LMU-A1



10-2. Power supply for Heat source unit

10-2-1. Electrical characteristics of Heat source unit

Symbols: MCA: Minimum Circuit Ampacity

PQRY-P-T(S)LMU

Model	Unit Combination	Heat source unit					Compressor	
		Hz	Volts	Voltage range	MCA (A)	MOP (A)	Output (kW)	SC (A)
PQRY-P72TLMU	-	60Hz	208/230V	188 to 253V	13/12	20/20	4.3	15
PQRY-P96TLMU	-				19/17	30/25	6.0	15
PQRY-P120TLMU	-				29/26	50/45	7.7	15
PQRY-P144TLMU	-				35/32	60/50	9.5	15
PQRY-P168TLMU	-				44/39	70/70	11.0	15
PQRY-P192TLMU	-				54/49	90/80	12.4	15
PQRY-P216TLMU	-				69/63	110/110	14.5	15
PQRY-P240TLMU	-				79/71	125/125	16.1	15
PQRY-P144TSLMU	PQRY-P72TLMU				13/12	20/20	4.3	15
	PQRY-P72TLMU				13/12	20/20	4.3	15
PQRY-P168TSLMU	PQRY-P72TLMU				13/12	20/20	4.3	15
	PQRY-P96TLMU				19/17	30/25	6.0	15
PQRY-P192TSLMU	PQRY-P96TLMU				19/17	30/25	6.0	15
	PQRY-P96TLMU				19/17	30/25	6.0	15
PQRY-P216TSLMU	PQRY-P96TLMU				19/17	30/25	6.0	15
	PQRY-P120TLMU				29/26	50/45	7.7	15
PQRY-P240TSLMU	PQRY-P120TLMU				29/26	50/45	7.7	15
	PQRY-P120TLMU				29/26	50/45	7.7	15
PQRY-P288TSLMU	PQRY-P144TLMU				35/32	60/50	9.5	15
	PQRY-P144TLMU				35/32	60/50	9.5	15
PQRY-P312TSLMU	PQRY-P144TLMU				35/32	60/50	9.5	15
	PQRY-P168TLMU				44/39	70/70	11.0	15
PQRY-P336TSLMU	PQRY-P168TLMU				44/39	70/70	11.0	15
	PQRY-P168TLMU				44/39	70/70	11.0	15

PQRY-P-Y(S)LMU

Model	Unit Combination	Heat source unit					Compressor	
		Hz	Volts	Voltage range	MCA (A)	MOP (A)	Output (kW)	SC (A)
PQRY-P72YLMU	-	60Hz	460V	414 to 506V	6	15	4.3	7
PQRY-P96YLMU	-				9	15	6.0	7
PQRY-P120YLMU	-				13	20	7.7	7
PQRY-P144YLMU	-				16	25	9.5	7
PQRY-P168YLMU	-				20	35	11.0	7
PQRY-P192YLMU	-				25	40	12.4	7
PQRY-P216YLMU	-				31	50	14.5	7
PQRY-P240YLMU	-				36	60	16.1	7
PQRY-P144YSLMU	PQRY-P72YLMU				6	15	4.3	7
	PQRY-P72YLMU				6	15	4.3	7
PQRY-P168YSLMU	PQRY-P72YLMU				6	15	4.3	7
	PQRY-P96YLMU				9	15	6.0	7
PQRY-P192YSLMU	PQRY-P96YLMU				9	15	6.0	7
	PQRY-P96YLMU				9	15	6.0	7
PQRY-P216YSLMU	PQRY-P96YLMU				9	15	6.0	7
	PQRY-P120YLMU				13	20	7.7	7
PQRY-P240YSLMU	PQRY-P120YLMU				13	20	7.7	7
	PQRY-P120YLMU				13	20	7.7	7
PQRY-P288YSLMU	PQRY-P144YLMU				16	25	9.5	7
	PQRY-P144YLMU				16	25	9.5	7
PQRY-P312YSLMU	PQRY-P144YLMU				16	25	9.5	7
	PQRY-P168YLMU				20	35	11.0	7
PQRY-P336YSLMU	PQRY-P168YLMU				20	35	11.0	7
	PQRY-P168YLMU				20	35	11.0	7

PQRY-P-T(S)LMU-A1, Y(S)LMU-A1

10-3. Power cable specifications

Thickness of wire for main power supply, capacities of the switch and system impedance

	Model	Minimum wire thickness [mm ² (AWG)]			Breaker for current leakage
		Main cable	Branch	Ground	
Heat source unit	PQRY-P72TLMU	3.3 (12)	-	3.3 (12)	30 mA or 100 mA 0.1sec. or less
	PQRY-P96TLMU	5.3 (10)	-	5.3 (10)	30 mA or 100 mA 0.1sec. or less
	PQRY-P120TLMU	8.4 (8)	-	8.4 (8)	100 mA 0.1sec. or less
	PQRY-P144TLMU	13.3 (6)	-	13.3 (6)	100 mA 0.1sec. or less
	PQRY-P168TLMU	13.3 (6)	-	13.3 (6)	100 mA 0.1sec. or less
	PQRY-P192TLMU	21.2 (4)	-	21.2 (4)	100 mA 0.1sec. or less
	PQRY-P216TLMU	33.6 (2)	-	33.6 (2)	100 mA 0.1sec. or less
	PQRY-P240TLMU	33.6 (2)	-	33.6 (2)	100 mA 0.1sec. or less

	Model	Minimum wire thickness [mm ² (AWG)]			Breaker for current leakage
		Main cable	Branch	Ground	
Heat source unit	PQRY-P72YLMU	2.1 (14)	-	2.1 (14)	30 mA or 100 mA 0.1sec. or less
	PQRY-P96YLMU	2.1 (14)	-	2.1 (14)	30 mA or 100 mA 0.1sec. or less
	PQRY-P120YLMU	3.3 (12)	-	3.3 (12)	30 mA or 100 mA 0.1sec. or less
	PQRY-P144YLMU	3.3 (12)	-	3.3 (12)	30 mA or 100 mA 0.1sec. or less
	PQRY-P168YLMU	5.3 (10)	-	5.3 (10)	30 mA or 100 mA 0.1sec. or less
	PQRY-P192YLMU	5.3 (10)	-	5.3 (10)	30 mA or 100 mA 0.1sec. or less
	PQRY-P216YLMU	8.4 (8)	-	8.4 (8)	100 mA 0.1sec. or less
		PQRY-P240YLMU	13.3 (6)	-	13.3 (6)

1. Use dedicated power supplies for the heat source unit and indoor unit. Ensure OC and OS are wired individually.
2. Bear in mind ambient conditions (ambient temperature, direct sunlight, rain water, etc.) when proceeding with the wiring and connections.
3. The wire size is the minimum value for metal conduit wiring. If the voltage drops, use a wire that is one rank thicker in diameter. Make sure the power-supply voltage does not drop more than 10%. Make sure that the voltage imbalance between the phases is 2% or less.
4. Specific wiring requirements should adhere to the wiring regulations of the region.
5. Power supply cords of parts of appliances for heat source use shall not be lighter than polychloroprene sheathed flexible cord (design 245 IEC57). For example,
6. A switch with at least 3 mm [1/8 in.] contact separation in each pole shall be provided by the Air Conditioner installer.

⚠ WARNING

- ◆ Be sure to use specified wires for connections and ensure no external force is imparted to terminal connections. If connections are not fixed firmly, heating or fire
- ◆ Be sure to use the appropriate type of overcurrent protection switch. Note that generated overcurrent may include some amount of direct current.

⚠ CAUTION

- ◆ The breakers for current leakage should support Inverter circuit. (e.g. Mitsubishi Electric's NV-C series or equivalent). If no earth leakage breaker is installed, it
 - ◆ Breakers for current leakage should combine using of switch.
 - ◆ Do not use anything other than a breaker with the correct capacity. Using a breaker of too large capacity may cause malfunction or fire.
 - ◆ If a large electric current flows due to malfunction or faulty wiring, earth-leakage breakers on the unit side and on the upstream side of the power supply system may both operate.
- Depending on the importance of the system, separate the power supply system or take protective coordination of breakers.

10-4. Power supply examples

The local standards and/or regulations is applicable at a higher priority.

10-4-1. PQR-Y-P72, 96, 120, 144, 168, 192, 216, 240TLMU/YLMU

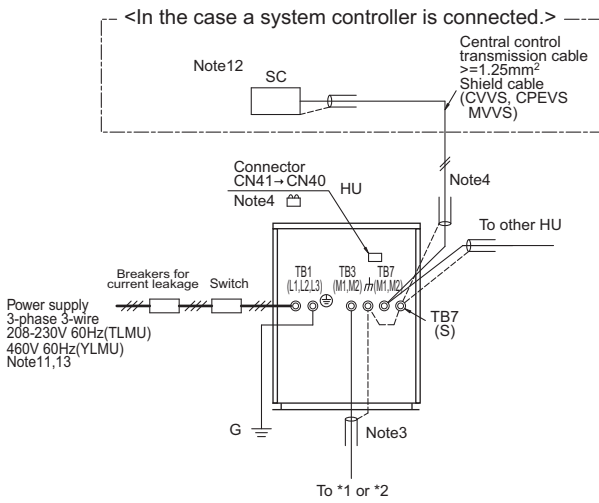

- Note:
- 1 The transmission cable is not-polarity double-wire.
 - 2 Symbol Ⓞ means a screw terminal for wiring.
 - 3 The shield wire of transmission cable should be connected to the grounding terminal at Heat source unit. All shield wire of M-Net transmission cable among Indoor units should be connected to the S terminal at Indoor unit or all shield wire should be connected together. The broken line at the scheme means shield wire.
 - 4 When the Heat source unit connected with system controller, power-supply to TB7 of the heat source unit(s) is needed. The connector change from CN41 to CN40 at one of the heat source units will enable the heat source unit to supply power to TB7, or an extra power supply unit PAC-SC51KUA should be used. The transmission cable (above 1.25mm², shielded, CVVS/CPEVS/MVVS) among Heat source units and system controllers is called central control transmission cable. The shield wire of the central control transmission cable must be grounded at the Heat source unit whose CN41 is changed to CN40. When the power supply unit PAC-SC51KUA is used, connect the shielded cable to the ground terminal on the PAC-SC51KUA.
 - 5 MA R/C transmission cable (0.3-1.25mm²) must be less than 200m in length, while ME R/C transmission cable (0.3-1.25mm²) must be less than 10m in length. But transmission cable to the ME R/C can be extended using a M-NET cable (>=1.25mm²) when the length is counted in the M-Net length.
 - 6 To wire PAR-CT01MAU, PAR-40MAU, and PAC-YT53CRAU, use a wire with a diameter of 0.3mm² [AWG 22].
 - 7 MA remote controller and ME remote controller should not be grouped together. When a PAR-CT01MAU or PAR-40MAU is connected to a group, no other MA remote controllers can be connected to the same group.
 - 8 If using 1 or 2 (main/sub) MA remote controller to control more than 1 Indoor unit, use MA transmission cable to connect all the TB15 terminals of the Indoor units. It is called "Grouping". If using 1 or 2 (main/sub) ME remote controller control more than 1 indoor unit, set address to Indoor unit and ME remote controller. For the method, refer to 11-4. "Address setting".
 - 9 Indoor board consumes power from TB3. The power balance should be considered according to System Design 11-3. "System configuration restrictions".
 - 10 If Transmission booster is needed, be sure to connect the shield wires to the both sides to the booster.
 - 11 The critical current for choosing power source equipment is approximate 1.4 times of total rated current of the Heat source unit(s) or Indoor unit(s).
 - 12 When System controller (SC) is connected to the system, turn the SW2-1 on.
 - 13 The phases of electricity power must be confirmed to be right used. Phase-reverse, or phase-missing could break the controllers.

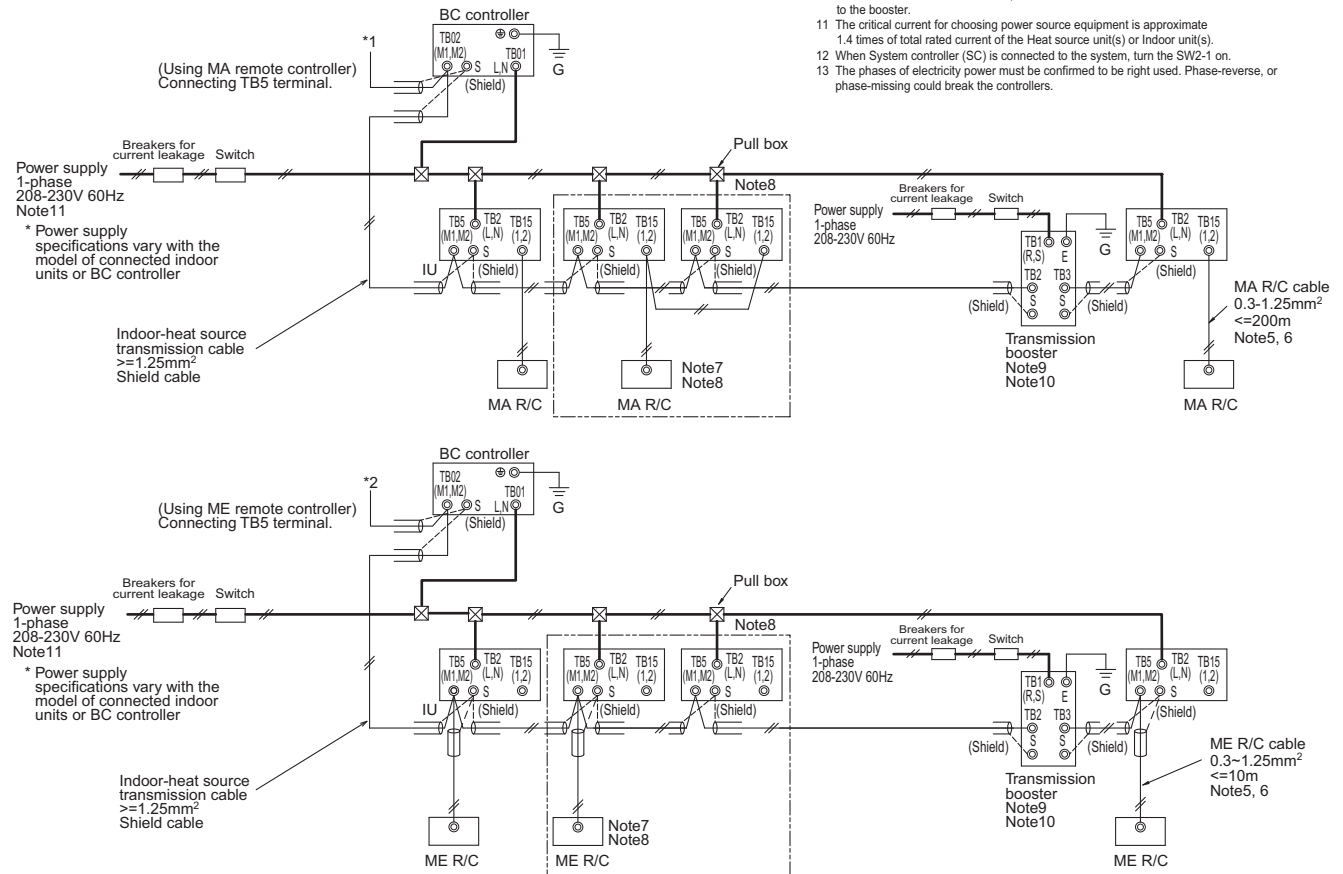

Symbol	Model	Minimum Wire thickness		Breaker for current leakage	
		Power wire [mm²(AWG)]	G wire [mm²(AWG)]		
BKC	Breaker capacity	PQR-Y-P72TLMU	3.3 (12)	3.3 (12)	30 mA or 100 mA 0.1sec. or less
OC	Over-current protector	PQR-Y-P96TLMU	5.3 (10)	5.3 (10)	30 mA or 100 mA 0.1sec. or less
NFB	Non-fuse breaker	PQR-Y-P120TLMU	8.4 (8)	8.4 (8)	100 mA 0.1sec. or less
HU	Heat source unit	PQR-Y-P144TLMU	13.3 (6)	13.3 (6)	100 mA 0.1sec. or less
IU	Indoor unit	PQR-Y-P168TLMU	13.3 (6)	13.3 (6)	100 mA 0.1sec. or less
SC	System controller	PQR-Y-P192TLMU	21.2 (4)	21.2 (4)	100 mA 0.1sec. or less
MA R/C	MA remote controller	PQR-Y-P216TLMU	33.6 (2)	33.6 (2)	100 mA 0.1sec. or less
ME R/C	ME remote controller	PQR-Y-P240TLMU	33.6 (2)	33.6 (2)	100 mA 0.1sec. or less
		PQR-Y-P72YLMU	2.1 (14)	2.1 (14)	30 mA or 100 mA 0.1sec. or less
		PQR-Y-P96YLMU	2.1 (14)	2.1 (14)	30 mA or 100 mA 0.1sec. or less
		PQR-Y-P120YLMU	3.3 (12)	3.3 (12)	30 mA or 100 mA 0.1sec. or less
		PQR-Y-P144YLMU	3.3 (12)	3.3 (12)	30 mA or 100 mA 0.1sec. or less
		PQR-Y-P168YLMU	5.3 (10)	5.3 (10)	30 mA or 100 mA 0.1sec. or less
		PQR-Y-P192YLMU	5.3 (10)	5.3 (10)	30 mA or 100 mA 0.1sec. or less
		PQR-Y-P216YLMU	8.4 (8)	8.4 (8)	100 mA 0.1sec. or less
		PQR-Y-P240YLMU	13.3 (6)	13.3 (6)	100 mA 0.1sec. or less

The local standards and/or regulations is applicable at a higher priority.

10-4-2. PQR-Y-P144, 168, 192, 216, 240, 288, 312, 336TSLMU/YSLMU

PQR-Y-P-T(S)LMU-A1, Y(S)LMU-A1

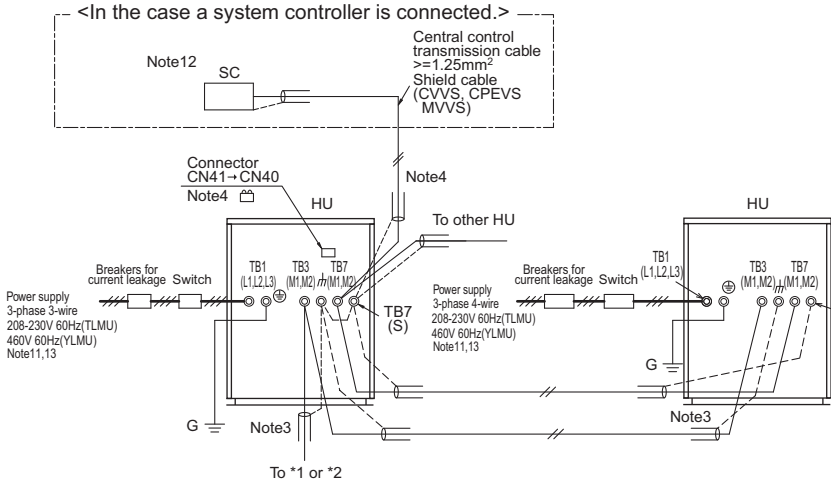

Note:

- 1 The transmission cable is not-polarity double-wire.
- 2 Symbol Ⓞ means a screw terminal for wiring.
- 3 The shield wire of transmission cable should be connected to the grounding terminal at Heat source unit. All shield wire of M-Net transmission cable among Indoor units should be connected to the S terminal at Indoor unit or all shield wire should be connected together.
The broken line at the scheme means shield wire.
- 4 When the Heat source unit connected with system controller, power-supply to TB7 of the heat source unit(s) is needed. The connector change from CN41 to CN40 at one of the heat source units will enable the heat source unit to supply power to TB7, or an extra power supply unit PAC-SC51KUA should be used. The transmission cable (above 1.25mm², shielded, CVVS/CPEVS/MVVS) among Heat source units and system controllers is called central control transmission cable. The shield wire of the central control transmission cable must be grounded at the Heat source unit whose CN41 is changed to CN40. When the power supply unit PAC-SC51KUA is used, connect the shielded cable to the ground terminal on the PAC-SC51KUA.
- 5 MA R/C transmission cable (0.3-1.25mm²) must be less than 200m in length, while ME R/C transmission cable (0.3-1.25mm²) must be less than 10m in length. But transmission cable to the ME R/C can be extend using a M-NET cable (>=1.25mm²) when the length is counted in the M-Net length.
- 6 To wire PAR-CT01MAU, PAR-40MAAU, and PAC-YT53CRAU, use a wire with a diameter of 0.3mm² [AWG 22].
- 7 MA remote controller and ME remote controller should not be grouped together. When a PAR-CT01MAU or PAR-40MAAU is connected to a group, no other MA remote controllers can be connected to the same group.
- 8 If using 1 or 2 (main/sub) MA remote controller to control more than 1 Indoor unit, use MA transmission cable to connect all the TB15 terminals of the Indoor units. It is called "Grouping".
If using 1 or 2 (main/sub) ME remote controller control more than 1 indoor unit, set address to Indoor unit and ME remote controller. For the method, refer to 11-4. "Address setting".
- 9 Indoor board consumes power from TB3. The power balance should be considered according to System Design 11-3. "System configuration restrictions".
- 10 If Transmission booster is needed, be sure to connect the shield wires to the both sides to the booster.
- 11 The critical current for choosing power source equipment is approximate 1.4 times of total rated current of the Heat source unit(s) or Indoor unit(s).
- 12 When System controller (SC) is connected to the system, turn the SW2-1 on.
- 13 The phases of electricity power must be confirmed to be right used. Phase-reverse, or phase-missing could break the controllers.

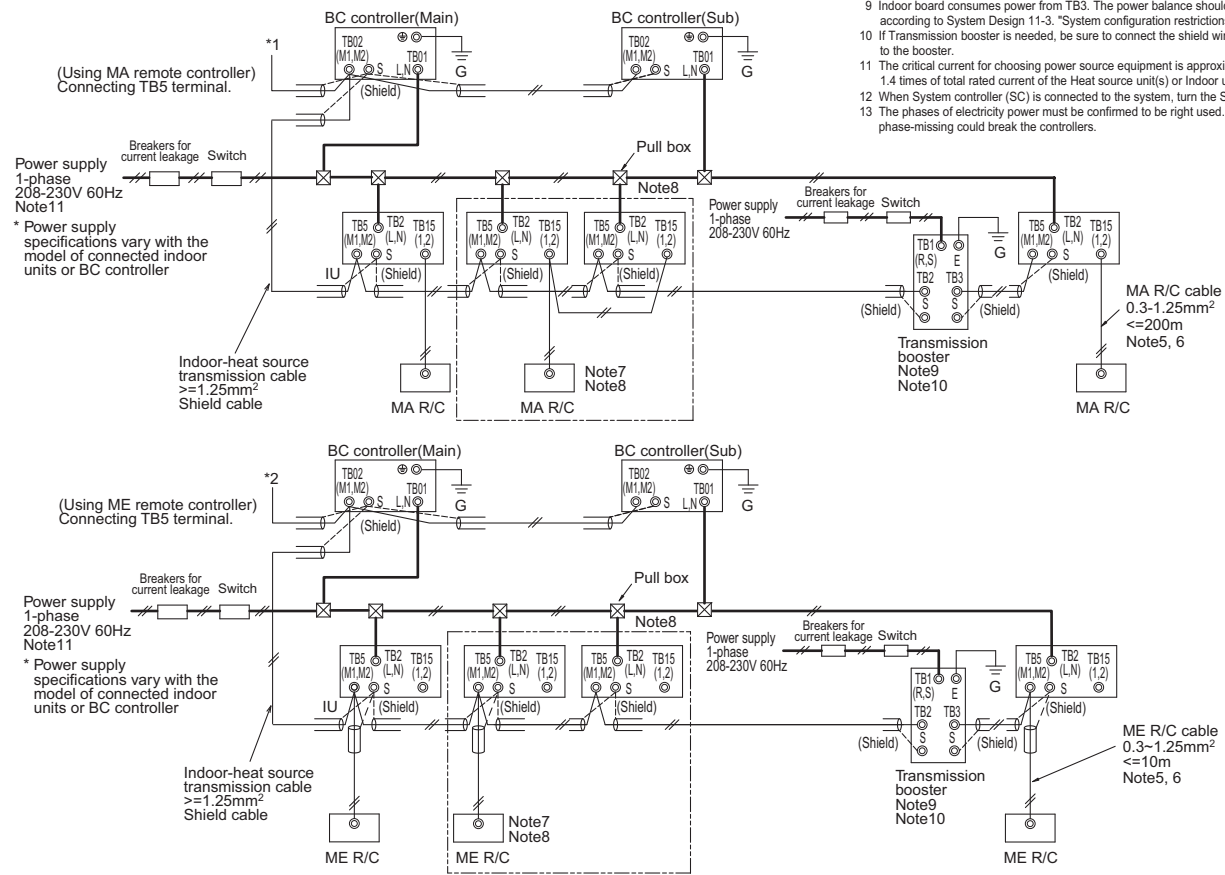

Symbol	Model	Minimum Wire thickness		Breaker for current leakage	
		Power wire [mm ² (AWG)]	G wire [mm ² (AWG)]		
BKC	Breaker capacity	PQR-Y-P72TLMU	3.3 (12)	3.3 (12)	30 mA or 100 mA 0.1sec. or less
OC	Over-current protector	PQR-Y-P96TLMU	5.3 (10)	5.3 (10)	30 mA or 100 mA 0.1sec. or less
NFB	Non-fuse breaker	PQR-Y-P120TLMU	8.4 (8)	8.4 (8)	100 mA 0.1sec. or less
HU	Heat source unit	PQR-Y-P144TLMU	13.3 (6)	13.3 (6)	100 mA 0.1sec. or less
IU	Indoor unit	PQR-Y-P168TLMU	13.3 (6)	13.3 (6)	100 mA 0.1sec. or less
SC	System controller	PQR-Y-P192TLMU	21.2 (4)	21.2 (4)	100 mA 0.1sec. or less
MA R/C	MA remote controller	PQR-Y-P216TLMU	33.6 (2)	33.6 (2)	100 mA 0.1sec. or less
ME R/C	ME remote controller	PQR-Y-P240TLMU	33.6 (2)	33.6 (2)	100 mA 0.1sec. or less
		PQR-Y-P72YLMU	2.1 (14)	2.1 (14)	30 mA or 100 mA 0.1sec. or less
		PQR-Y-P96YLMU	2.1 (14)	2.1 (14)	30 mA or 100 mA 0.1sec. or less
		PQR-Y-P120YLMU	3.3 (12)	3.3 (12)	30 mA or 100 mA 0.1sec. or less
		PQR-Y-P144YLMU	3.3 (12)	3.3 (12)	30 mA or 100 mA 0.1sec. or less
		PQR-Y-P168YLMU	5.3 (10)	5.3 (10)	30 mA or 100 mA 0.1sec. or less
		PQR-Y-P192YLMU	5.3 (10)	5.3 (10)	30 mA or 100 mA 0.1sec. or less
		PQR-Y-P216YLMU	8.4 (8)	8.4 (8)	100 mA 0.1sec. or less
		PQR-Y-P240YLMU	13.3 (6)	13.3 (6)	100 mA 0.1sec. or less

11-1. Transmission cable length limitation

11-1-1. Using MA Remote controller

MA remote controller refers to Simple MA remote controller and wireless remote controller.

Long transmission cable causes voltage down, therefore, the length limitation should be obeyed to secure proper transmission.

Max. length via Heat source (M-NET cable)	$L1+L2+L3, L1+L2+L4+L5, L3+L4+L5, L6+L2+L3, L6+L2+L4+L5$	$\leq 500m[1640ft.]$	1.25mm ² [AWG16] or thicker
Max. length to Heat source (M-NET cable)	$L1+L6, L3, L2+L4+L6, L5$	$\leq 200m[656ft.]$	1.25mm ² [AWG16] or thicker
Max. length from MA to Indoor for each group	$a1+a2, a1+a2+a3+a4$	$\leq 200m[656ft.]$	0.3-1.25 mm ² [AWG22-16]
24VDC to AG-150A-A	n	$\leq 50m[164ft.]$	0.75-2.0 mm ² [AWG18-14]

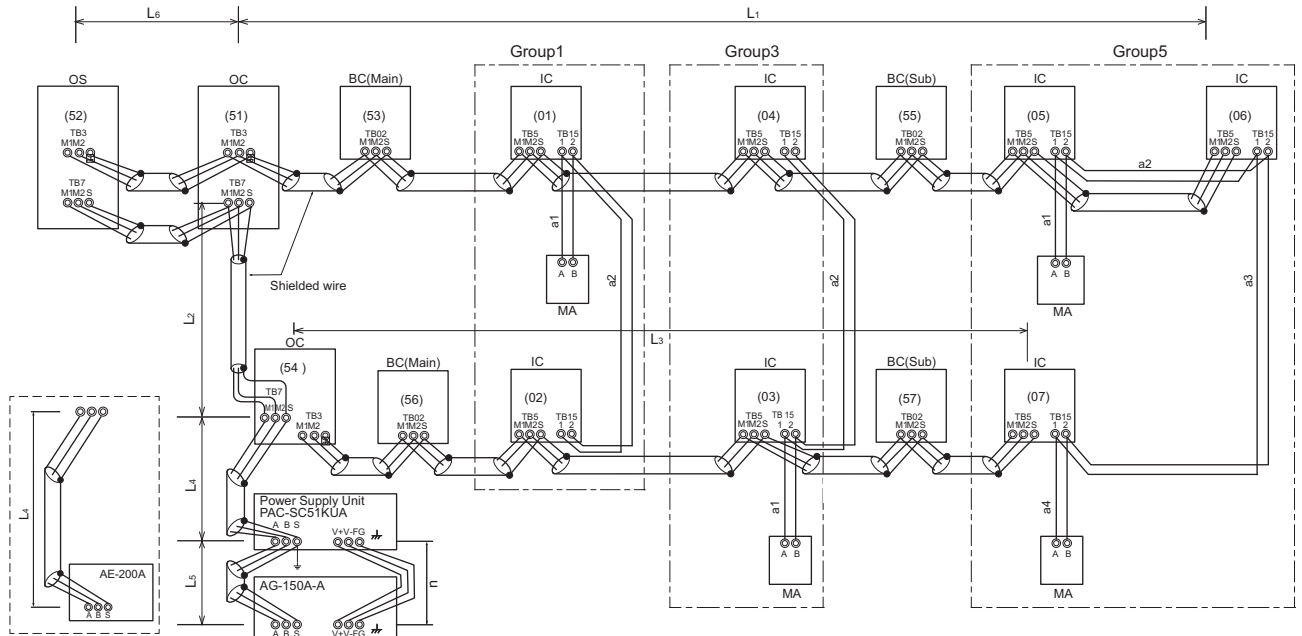

OC, OS: Heat source unit controller; IC: Indoor unit controller; ME: ME remote controller

11-1-2. Using ME Remote controller

ME remote controller refers to Smart ME Controller.

Long transmission cable causes voltage down, therefore, the length limitation should be obeyed to secure proper transmission.

Max. length via Heat source (M-NET cable)	$L1+L2+L3+L4, L1+L2+L6+L7, L1+L2+L3+L5, L3+L4+L6+L7, L8+L2+L3+L4, L8+L2+L3+L5, L8+L2+L6+L7, L3+L5+L6+L7$	$\leq 500m[1640ft.]$	1.25mm ² [AWG16] or thicker
Max. length to Heat source (M-NET cable)	$L1+L8, L3+L4, L2+L6+L8, L7, L3+L5$	$\leq 200m[656ft.]$	1.25mm ² [AWG16] or thicker
Max. length from ME to Indoor	$e1, e2, e3, e4$	$\leq 10m[32ft.]*1$	0.3-1.25 mm ² [AWG22-16]*1
24VDC to AG-150A-A	n	$\leq 50m[164ft.]$	0.75-2.0 mm ² [AWG18-14]

*1. If the length from ME to Indoor exceed 10m, use 1.25 mm² [AWG16] shielded cable, but the total length should be counted into Max. length via Heat source.

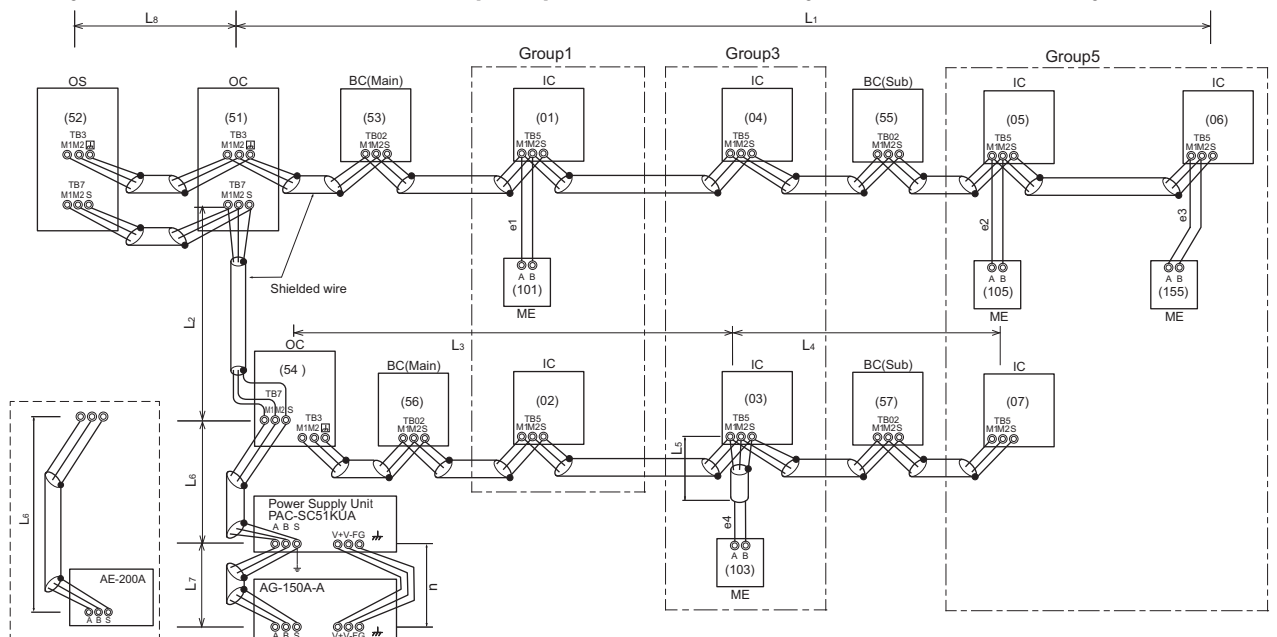

OC, OS: Heat source unit controller; IC: Indoor unit controller; ME: ME remote controller

11-2. Transmission cable specifications

	Transmission cables (Li)	ME Remote controller cables	MA Remote controller cables
Type of cable	Shielding wire (2-core) CVVS, CPEVS or MVVS	Sheathed 2-core cable (unshielded) CVV	
Cable size	More than 1.25mm ² [AWG16]	0.3~1.25mm ² [AWG22~16]	0.3~1.25mm ² [AWG22~16]*1
Remarks	—	When 10m [32ft] is exceeded, use cables with the same specification as transmission cables.	Max length : 200m [656ft]

*1 To wire PAR-CT01MAU, PAR-40MAAU, and PAC-YT53CRAU, use a wire with a diameter of 0.3 mm² [AWG22]

CVVS, MVVS: PVC insulated PVC sheathed shielded control cable
CPEVS: PE insulated PVC sheathed shielded communication cable
CVV: PVC insulated PVC sheathed control cable

11-3. System configuration restrictions

11-3-1. Common restrictions for the CITY MULTI system

For each Outdoor/Heat source unit, the maximum connectable quantity of Indoor unit is specified at its Specifications table.

- A) 1 Group of Indoor units can have 1-16 Indoor units;
- B) Maximum 2 remote controllers for 1 group;
 - *MA/ME remote controllers cannot be present together in 1group.
 - *When a PAR-CT01MAU or PAR-40MAAU is connected to a group, no other MA remote controllers can be connected to the same group.
 - *To wire PAR-CT01MAU, PAR-40MAAU, and PAC-YT53CRAU, use a wire with a diameter of 0.3 mm² [AWG22]
- C) 1 Lossnay unit can interlock maximum 16 Indoor units; 1 Indoor unit can interlock only 1 Lossnay unit.
- D) Maximum 3 System controllers are connectable when connecting to TB3 of the Outdoor/Heat source unit.
- E) A maximum of 6 system controller are connectable to TB3 and TB7 of Outdoor/Heat source unit.
- F) 4 System controllers or more are connectable when connecting to TB7 of the Outdoor/Heat source unit, if the transmission power is supplied by the power supply unit PAC-SC51KUA.
 - *System controller connected as described in D) would have a risk that the failure of connected Outdoor/Heat source unit would stop power supply to the System controller.

11-3-2. Ensuring proper communication power and the number of connected units for M-NET

In order to ensure proper communication among Outdoor/Heat source unit, Indoor unit, Lossnay, and Controllers, the transmission power situation for the M-NET should be observed. In some cases, Transmission booster should be used. Taking the power consumption of Indoor unit as 1, the equivalent power consumption or supply of others are listed at Table 1 and Table 2.

Both the transmission line for centralized controller and indoor-outdoor transmission line must meet the conditions listed below. (Both conditions a) and b) must be met.)

- a) [Total equivalent power consumption] ≤ [The equivalent power supply]
- b) [Total equivalent number of units (Table1)] ≤ [40]

Table 1 The equivalent power consumption and the equivalent number of units

Category	Model	The equivalent power consumption	The equivalent number of units
Indoor unit	Sized P04-P96, PEFY-AF1200CFM-E	1	1
	PEFY-AF1200CFMR-E	2	2
BC controller	CMB	2	1
PWFY *1	P36NMU-E-BU	6	1
	P36NMU-E2-AU	1	1
	P72NMU-E2-AU	5	1
MA remote controller/Lossnay	PAR-CT01MAU PAR-40MAAU PAC-YT53CRAU PAR-FA32MA LGH-F-RX ₅ -E1 LGH-F-RVX-E PZ-60DR-E PZ-61DR-E PZ-43SMF-E	0	0
ME remote controller	PAR-U01MEDU	0.5	1
System controller	AE-200A AE-50A EW-50A LM-AP	0	0
	AG-150A-A EB-50GU-A PAC-IF01AHC-J	0.5	1
	TC-24B	1.5	5
	PAC-YG60MCA PAC-YG66DCA PAC-YG63MCA	0.25	1
ON/OFF controller	PAC-YT40ANRA	1	1
MN converter	CMS-MNG-E	2	1
Outdoor/Heat source unit	TB7 power consumption	0	0
System control interface	MAC-333IF-E	0	0
A-M converter	PAC-IF01MNT-E	1	2

*1 PWFY cannot be connected to PUMY model.

Table 2 The equivalent power supply

Category	Model	The equivalent power supply		
Transmission Booster	PAC-SF46EPA-G	25 *1		
Power supply unit	PAC-SC51KUA	5		
Expansion controller	PAC-YG50ECA	6		
BM ADAPTER	BAC-HD150	6		
System controller	AE-200A/AE-50A	0.75		
	EW-50A	1.5		
	LM-AP	0		
Outdoor/Heat source unit		TB3 and TB7 total	TB7 only	TB3 only
	Outdoor unit other than the following units *2	32 *1	6	32*1 - equivalent power supplied to TB7
	S-Series outdoor unit	12 *1	0	12 *1
	TLMU/TKMU outdoor unit	32 *1	- *3	32 *1

*1 When one or more indoor units listed below is connected, subtract 3 from the equivalent power supply.

Table 3

Category	Model
Indoor unit	Sized P72, P96 PEFY-AF1200CFM(R)-E

*2 If PAC-SC51KUA is used to supply power at TB7 side, no power supply need from Outdoor/Heat source unit at TB7, Connector TB3 itself will therefore have 32.

With the equivalent power consumption values and the equivalent number of units in Table 1 and Table 2, PAC-SF46EPA-G can be designed into the air-conditioner system to ensure proper system communication according to (A), (B), (C).

- (A) Firstly, count from TB3 at TB3 side the total equivalent number of units of Indoor units, ME remote controller, and System controllers. If the total equivalent number of units reaches 40, a PAC-SF46EPA-G should be set.
- (B) Secondly, count from TB7 side to TB3 side the total transmission power consumption. If the total equivalent power supply reaches 32, a PAC-SF46EPA-G should be set. Yet, if a PAC-SC51KUA or another controller with a built-in power supply, such as PAC-YG50ECA, is used to supply power at TB7 side, count from TB3 side only.
- (C) Thirdly, count from TB7 at TB7 side the total transmission power consumption, If the total equivalent power supply for only TB7 reaches 6, a PAC-SF46EPA-G should be set. Also, count from TB7 at TB7 side the total equivalent number of units of System controllers, and so on. If the total equivalent number of units reaches 40, a PAC-SF46EPA-G should be set.

* The equivalent power supply of S-Series outdoor unit is 12.

* When one or more indoor units listed in Table 3 is connected, subtract 3 from the equivalent power supply.

■ System example

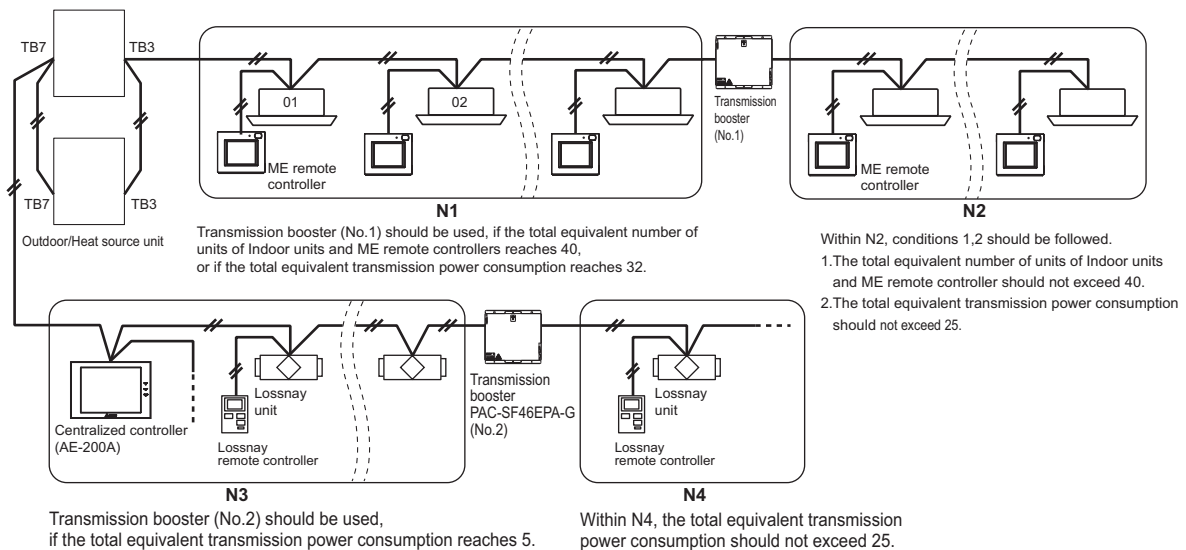

11-3-3. Ensuring proper power supply to System controller

The power to System controller (excluding AE-200A, AE-50A, EW-50A, BAC-HD150, LM-AP) is supplied via M-NET transmission line. M-NET transmission line at TB7 side is called Centralized control transmission line while one at TB3 side is called Indoor-Outdoor/Heat source transmission line. There are 3 ways to supply power to the System controller .

A) Connecting to TB3 of the Outdoor/Heat source unit and receiving power from the Outdoor/Heat source unit.

B) Connecting to TB7 of the Outdoor/Heat source unit and receiving power from the Outdoor/Heat source unit.

(Not applicable to the PUMY model)

C) Connecting to TB7 of the Outdoor/Heat source unit but receiving power from power supply unit PAC-SC51KUA.

* System controllers (AE-200A, AE-50A, EW-50A, BAC-HD150, LM-AP) have a built-in function to supply power to the M-NET transmission lines, so no power needs to be supplied to the M-NET transmission lines from the Outdoor/Heat source units or from PAC-SC51KUA.

11-3-3-A. When connecting to TB3 of the Outdoor/Heat source unit and receiving power from the Outdoor/Heat source unit.

Maximum 3 System controllers can be connected to TB3. If there is more than 1 Outdoor/Heat source unit, it is necessary to replace power supply switch connector CN41 with CN40 on one Outdoor/Heat source unit.

Fig. 11-3-3-A

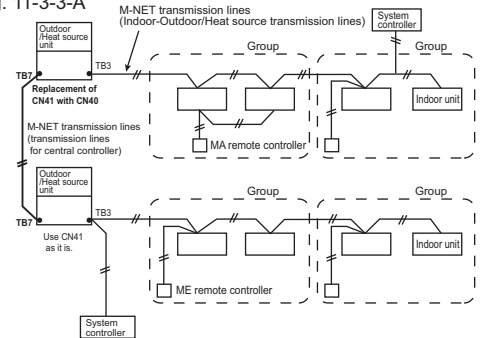

11-3-3-B. When connecting to TB7 of the Outdoor/Heat source unit and receiving power from the Outdoor/Heat source unit. (Not applicable to the PUMY model)

A maximum of 6 system controller are connectable to TB3 and TB7 of Outdoor/Heat source unit.

(Not applicable to the PUMY model)

It is necessary to replace power supply switch connector CN41 with CN40 on one Outdoor/Heat source unit.

Fig. 11-3-3-B

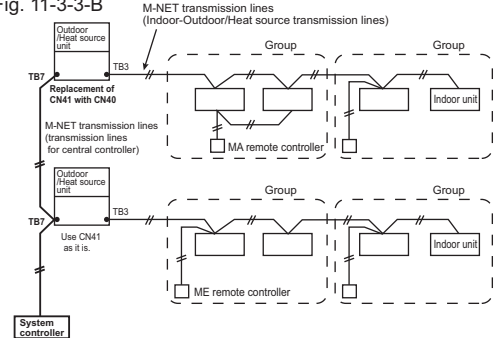

11-3-3-C. When connecting to TB7 of the Outdoor/Heat source unit but receiving power from PAC-SC51KUA.

When using PAC-SC51KUA to supply transmission power, the power supply connector CN41 on the Outdoor/Heat source units should be kept as it is. It is also a factory setting.

1 PAC-SC51KUA supports maximum 1 AG-150A-A or 1 EB-50GU-A unit due to the limited power 24VDC at its TB3. However, 1 PAC-SC51KUA supplies transmission power at its TB2 equal to 5 Indoor units, which is referable at Table 2.

If System controller, ON/OFF controller connected to TB7 consume transmission power more than 5 (Indoor units), Transmission booster PAC-SF46EPA-G is needed. PAC-SF46EPA-G supplies transmission power equal to 25 Indoor units.

Fig. 11-3-3-C

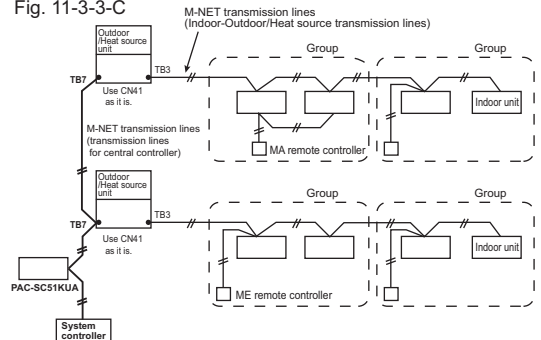

CAUTION

■How to connect system controllers (AE-200A, AE-50A, EW-50A, BAC-HD150, LM-AP) to a given system System controllers (AE-200A, AE-50A, EW-50A, BAC-HD150, LM-AP) have a built-in function to supply power to the M-NET transmission lines, so no power needs to be supplied to the M-NET transmission lines from the Outdoor/Heat source units or from PAC-SC51KUA.

Leave the power supply connector on the Outdoor/Heat source unit connected to CN41 as it is.

Refer to 11-3-2 for information about the power-supply capacity of each system controller (EW-50A, BAC-HD150, LM-AP) to the low-level system controllers.

Fig. 11-3-3-D

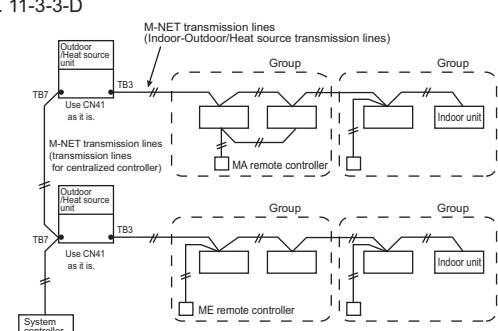

11-3-4. Power supply to LM-AP

1-phase 208-230VAC power supply is needed.

The power supply unit PAC-SC51KUA is not necessary when connecting only the LM-AP. Yet, make sure to change the power supply changeover connector CN41 to CN40 on the LM-AP.

11-3-5. Power supply to expansion controller

1-phase 100-240VAC power supply is needed.

The power supply unit PAC-SC51KUA is not necessary.

The expansion controller supplies power through TB3, which equals 6 indoor units. (refer to Table 2)

11-3-6. Power supply to BM ADAPTER

1-phase 100-240VAC power supply is needed.

The power supply unit PAC-SC51KUA is not necessary when only BM ADAPTER is connected.

Yet, make sure to move the power jumper from CN41 to CN40 on the BM ADAPTER.

11-3-7. Power supply to AE-200A/AE-50A/EW-50A

1-phase 100-240VAC power supply is needed.

The power supply unit PAC-SC51KUA is not necessary when connecting only the AE-200A/AE-50A/EW-50A.

11-4. Address setting

11-4-1. Switch operation

In order to constitute CITY MULTI in a complete system, switch operation for setting the unit address No. and connection No. is required.

- ① Address No. of heat source unit, indoor unit and ME remote controller.
The address No. is set at the address setting board.
In the case of WR2 system, it is necessary to set the same No. at the branch No. switch of indoor unit as that of the BC controller connected. (When connecting two or more branches, use the lowest branch No.)

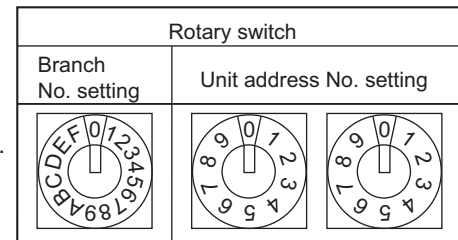

- ② Caution for switch operations

- Be sure to shut off power source before switch setting. If operated with power source on, switch can not operate properly.
- No units with identical unit address shall exist in one whole air conditioner system. If set erroneously, the system can not operate.

- ③ MA remote controller

- When connecting only one remote controller to one group, it is always the main remote controller. When connecting two remote controllers to one group, set one remote controller as the main remote controller and the other as the sub remote controller.
- The factory setting is "Main".

PAR-CT01MAU, PAR-40MAAU

The MA remote controller does not have the switches listed above.
Refer to the installation manual for the function setting.



























PAC-YT53CRAU

Setting the dip switches

There are switches on the back of the top case. Remote controller Main/Sub and other function settings are performed using these switches. Ordinarily, only change the Main/Sub setting of SW1.
(The factory settings are ON for SW1, 3, and 4 and OFF for SW2.)

SW No	SW contents Main	ON	OFF	Comment
1	Remote controller Main/Sub setting	Main	Sub	Set one of the two remote controllers at one group to "ON".
2	Temperature display units setting	Celsius	Fahrenheit	When the temperature is displayed in [Fahrenheit], set to "OFF".
3	Cooling/heating display in AUTO mode	Yes	No	When you do not want to display "Cooling" and "Heating" in the AUTO mode, set to "OFF".
4	Indoor temperature display	Yes	No	When you do not want to display the indoor temperature, set to "OFF".

11-4-2. Rule of setting address

Unit	Address setting	Example	Note
Indoor unit System control interface (MAC-333IF-E) A-M converter (PAC-IF01MNT-E)	01 ~ 50	 	Use the most recent address within the same group of indoor units. Make the indoor units address connected to the BC controller (Sub) larger than the indoor units address connected to the BC controller (Main). If applicable, set the sub BC controllers in an PQRY system in the following order: (1) Indoor unit to be connected to the BC controller (Main) (2) Indoor unit to be connected to the BC controller (No.1 Sub) (3) Indoor unit to be connected to the BC controller (No.2 Sub) Set the address so that (1)<(2)<(3)
Heat source unit	51 ~ 99, 100 (Note1)	 	The smallest address of indoor unit in same refrigerant system + 50 Assign sequential address numbers to the heat source units in one refrigerant circuit system. OC and OS are automatically detected. (Note 2) * Please reset one of them to an address between 51 and 99 when two addresses overlap. * The address automatically becomes "100" if it is set as "01~ 50"
BC controller (Main)	52 ~ 99, 100	 	The address of heat source unit + 1 * Please reset one of them to an address between 51 and 99 when two addresses overlap. * The address automatically becomes "100" if it is set as "01~ 50"
BC controller (Sub)	52 ~ 99, 100	 	Lowest address within the indoor units connected to the BC controller (Sub) plus 50.
Local remote controller	ME, Lossnay Remote controller (Main)	1 Fixed  	The smallest address of indoor unit in the group + 100 * The place of "100" is fixed to "1"
	ME, Lossnay Remote controller (Sub)	1 Fixed  	The address of main remote controller + 50 * The address automatically becomes "200" if it is set as "00"
System controller	ON/OFF remote controller	  	The smallest group No. to be managed + 200 * The smallest group No. to be managed is changeable.
	AE-200A/AE-50A AG-150A-A EB-50GU-A EW-50A TC-24B	0 0 0 100 10 1	* TC-24B cannot be set to "000".
	PAC-YG50ECA	0 0 0 100 10 1	* Settings are made on the initial screen of AG-150A-A.
	BAC-HD150	0 0 0 100 10 1	* Settings are made with setting tool of BM ADAPTER.
	LMAP04U-E	2 Fixed  	
PI, AI, DIDO	PAC-YG60MCA	 	
	PAC-YG63MCA	 	
	PAC-YG66DCA	 	
Lossnay	01 ~ 50	 	After setting the addresses of all the indoor units, assign an arbitrary address.
PAC-IF01AHC-J	201 ~ 250	2 Fixed  	

Note1: To set the address to "100", set it to "50"

Note2: Heat source units OC and OS in one refrigerant circuit system are automatically detected.
OC and OS are ranked in descending order of capacity. If units are the same capacity, they are ranked in ascending order of their address.

11-4-3. System examples

Factory setting

Original switch setting of the heat sources, indoors, controllers, LM-AP, and BM ADAPTER at shipment is as follows.

- Heat source unit : Address: 00, CN41: ON (Jumper), DipSW5-1: OFF
- Indoor unit : Address: 00
- BC controller : Address: 00
- ME remote controller : Address: 101
- LM-AP : Address: 247, CN41: ON (Jumper), DipSW1-2: OFF
- BM ADAPTER : Address: 000, CN41: ON (Jumper)
- AE-200A/AE-50A/EW-50A : Address: 000, CN21: ON (Jumper)

Setting at the site

- DipSW5-1(Heat source) : When the System Controller is used, all the Dip SW5-1 at the heat source units should be set to "ON". * Dip SW5-1 remains OFF when only LM-AP is used.
- DipSW1-2(LM-AP) : When the LM-AP is used together with System Controller, DipSW1-2 at the LM-AP should be set to "ON".
- CN40/CN41 : Change jumper from CN41 to CN 40 at heat source control board will activate central transmission power supply to TB7;
(Change jumper at only one heat source unit when activating the transmission power supply without using a power supply unit.)
Change jumper from CN41 to CN 40 at LM-AP/BM ADAPTER will activate transmission power supply to LM-AP/BM ADAPTER itself;
Power supply unit is recommended to use for a system having more than 1 heat source unit, because the central transmission power supply from TB7 of one of heat source units is risking that the heat source unit failure may let down the whole central control system.
- CN21(AE-200A/AE-50A/EW-50A) : Activates the power supply to M-NET transmission line from AE-200A/AE-50A/EW-50A (CN21: ON (power supplied), OFF (power not supplied))

11-4-3-1. MA remote controller, Single-refrigerant-system, No System Controller

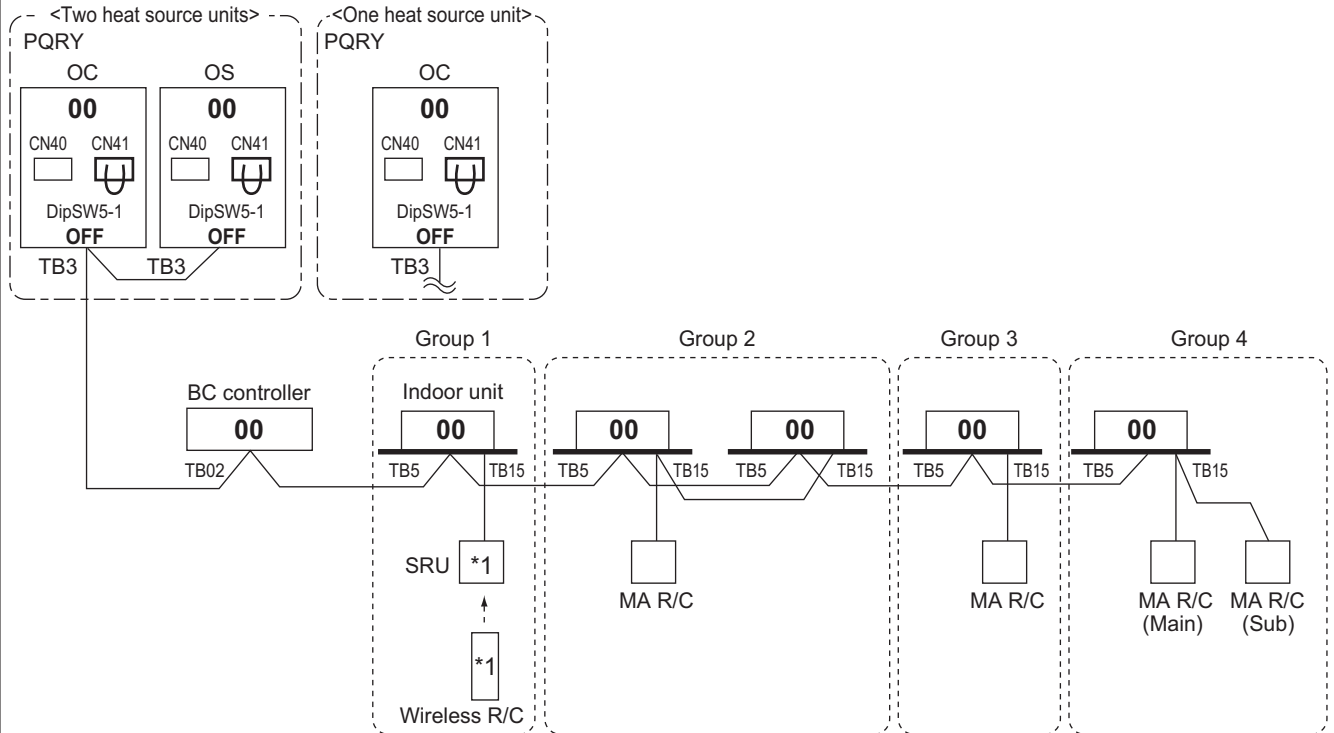

*1 For Wireless R/C and Signal receiver unit (SRU), channel 1, 2 and 3 are selectable and should be set to same channel.

NOTE:

1. Heat source units OC and OS in one refrigerant circuit system are automatically detected.
OC and OS are ranked in descending order of capacity. If units are the same capacity, they are ranked in ascending order of their address.
2. No address setting is needed.
3. For a system having more than 32 indoor unit, confirm the need of Booster at 11-3. "System configuration restrictions".
4. Indoor units should be set with a branch number.
5. Address setting is required if a sub BC controller is connected.
6. When a PAR-CT01MAU or PAR-40MAAU is connected to a group, no other MA remote controllers can be connected to the same group.

PQRY-P-T(S)LMU-A1, Y(S)LMU-A1

11-4-3-2. MA remote controller, Single-refrigerant-system, System Controller

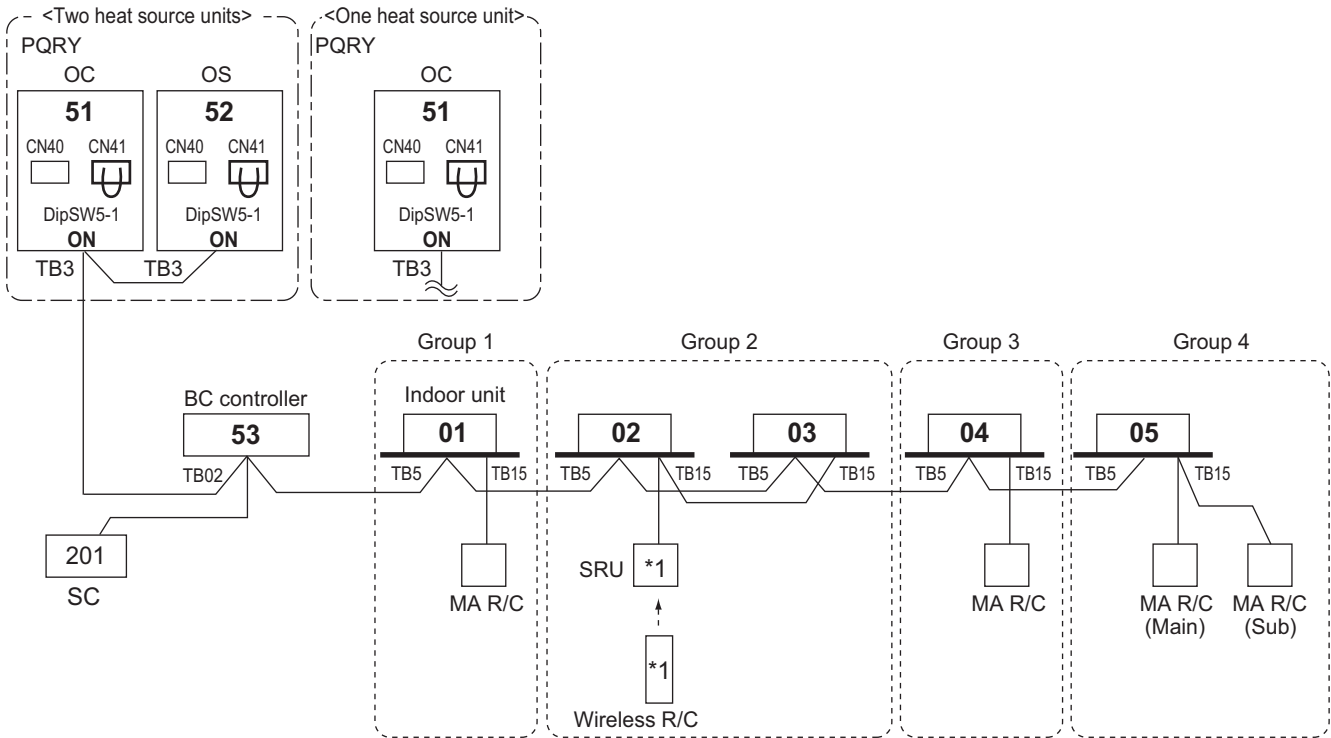

*1 For Wireless R/C and Signal receiver unit (SRU), channel 1, 2 and 3 are selectable and should be set to same channel.

*SC can be connected to TB3 side or TB7 side;

Should SC connected to TB7 side, change Jumper from CN41 to CN40 at the Heat source unit module so as to supply power to the SC.

NOTE:

1. Heat source units OC and OS in one refrigerant circuit system are automatically detected.
OC and OS are ranked in descending order of capacity. If units are the same capacity, they are ranked in ascending order of their address.
2. Address should be set to Indoor units and central controller.
3. For a system having more than 32 indoor unit, confirm the need of Booster at 11-3. **"System configuration restrictions"**.
4. Indoor units should be set with a branch number.
5. When a PAR-CT01MAU or PAR-40MAAU is connected to a group, no other MA remote controllers can be connected to the same group.

11-4-3-3. MA remote controller, Multi-refrigerant-system, System Controller at TB7/TB3 side, Booster for long M-NET wiring

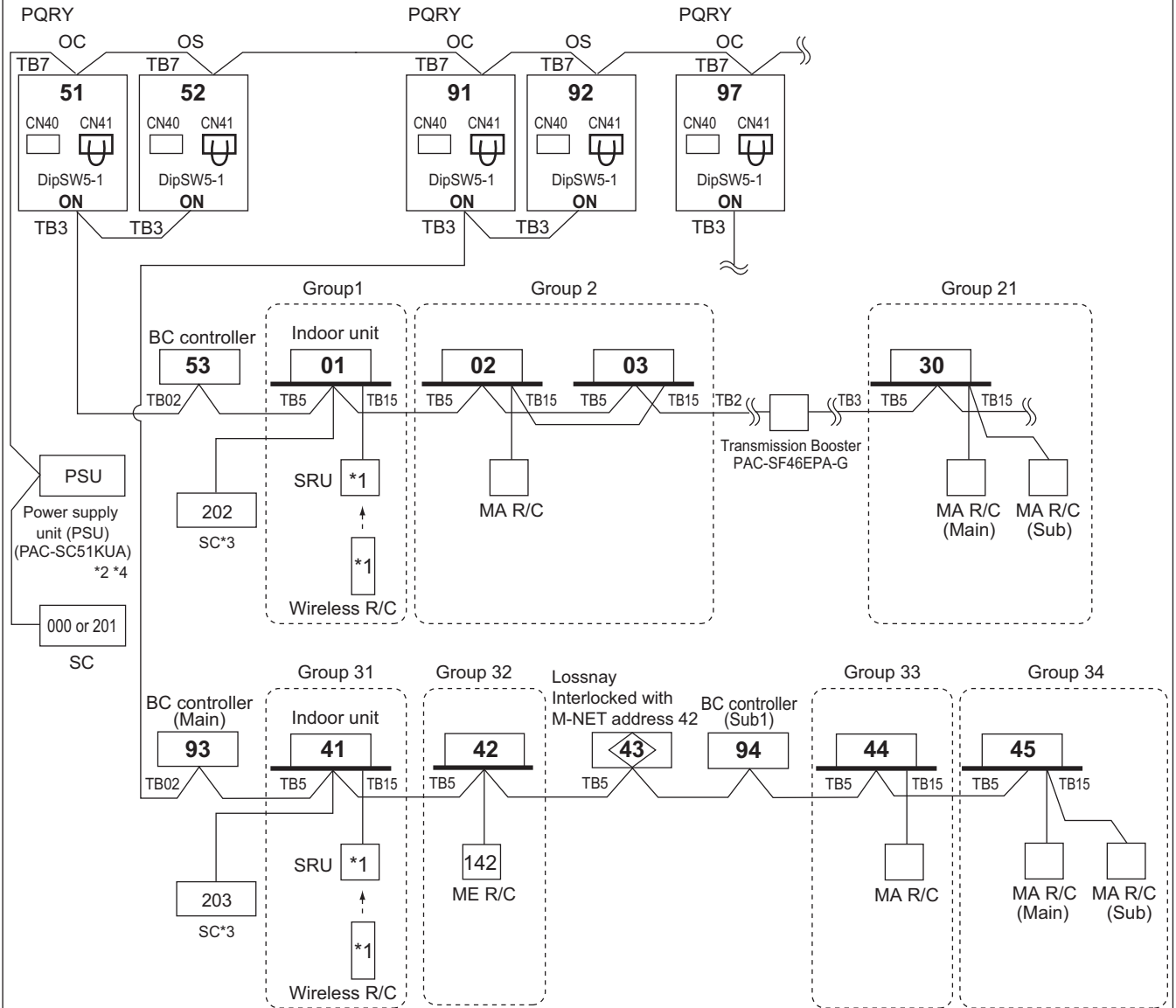

- *1 For Wireless R/C and Signal receiver unit (SRU), channel 1, 2 and 3 are selectable and should be set to same channel.
- *2 System controller should connect to TB7 at the Heat source unit and use power supply unit together in Multi-Refrigerant-System. For AG-150A-A, 24VDC should be used with the PAC-SC51KUA. For AE-200A, AE-50A, and EW-50A the power supply unit PAC-SC51KUA is unused.
- *3 When multiple system controllers are connected in the system, set the controller with more functions than others as a "main" controller and others as "sub". AE-200A, AE-50A, EW-50A, BAC-HD150, and LM-AP are for exclusive use as a "main" system controller and cannot be used as a "sub" system controller. Make the setting to only one of the system controllers for "prohibition of operation from local remote controller".
- *4 The power supply unit is not necessary for AE-200A, AE-50A, EW-50A, BAC-HD150, and LM-AP.

NOTE:

1. Heat source units OC and OS in one refrigerant circuit system are automatically detected. OC and OS are ranked in descending order of capacity. If units are the same capacity, they are ranked in ascending order of their address.
2. Address should be set to Indoor units, Lossnay and system controller.
3. M-NET power is supplied by the Heat source unit at TB3, while Indoor unit and ME remote controller consume the M-NET power for transmission use. The power balance is needed to consider for long M-NET wiring. Details refer to 11-3. "System configuration restrictions".
4. Indoor units should be set with a branch number.
5. Assign an address to each of the sub BC controllers which equals the sum of the smallest address of the indoor units that are connected to each sub BC controller and 50.
6. When a PAR-CT01MAU or PAR-40MAAU is connected to a group, no other MA remote controllers can be connected to the same group.

PQRY-P-T(S)LMU-A1, Y(S)LMU-A1

PQRY-P-T(S)LMU-A1, Y(S)LMU-A1

11-4-3-4. ME remote controller, Single-refrigerant-system, No system controller

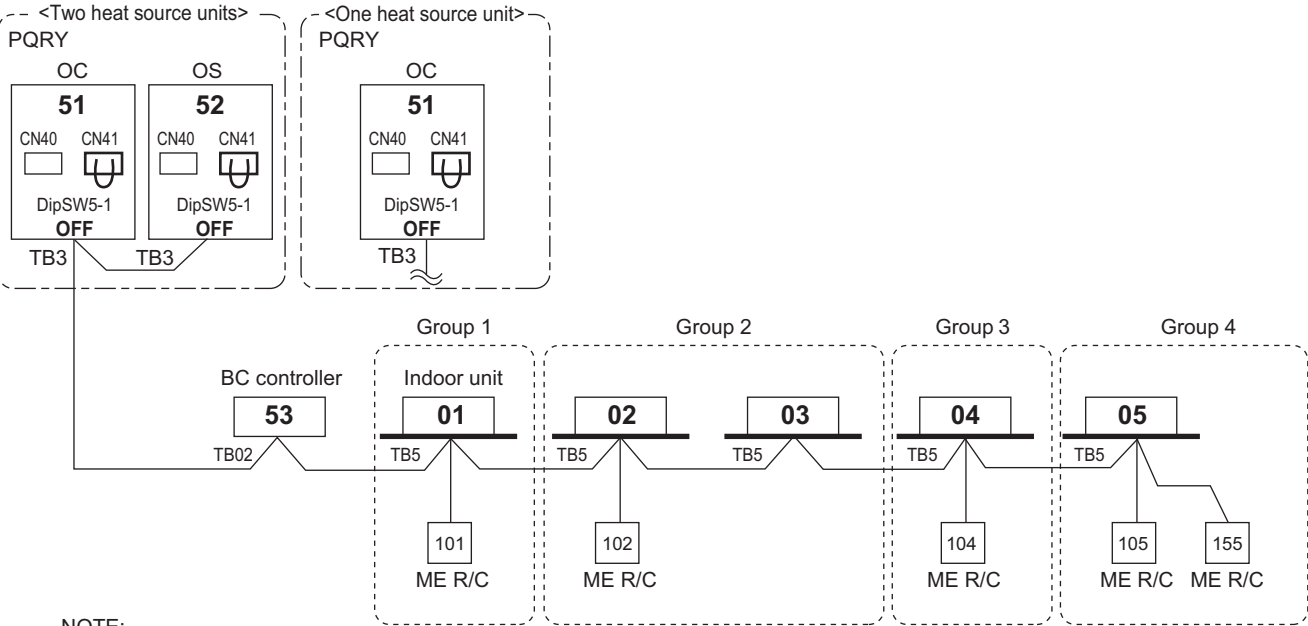

NOTE:

- Heat source units OC and OS in one refrigerant circuit system are automatically detected. OC and OS are ranked in descending order of capacity. If units are the same capacity, they are ranked in ascending order of their address.
- Address should be set to Indoor units, system controller and ME remote controllers.
- M-NET power is supplied by the Heat source unit at TB3, while Indoor unit and ME R/C consume the M-NET power for transmission use. The power balance is needed to consider for long M-NET wiring. Details refer to 11-3. "System configuration restrictions".
- Indoor units should be set with a branch number.

11-4-3-5. ME remote controller, Single-refrigerant-system, System controller, Lossnay

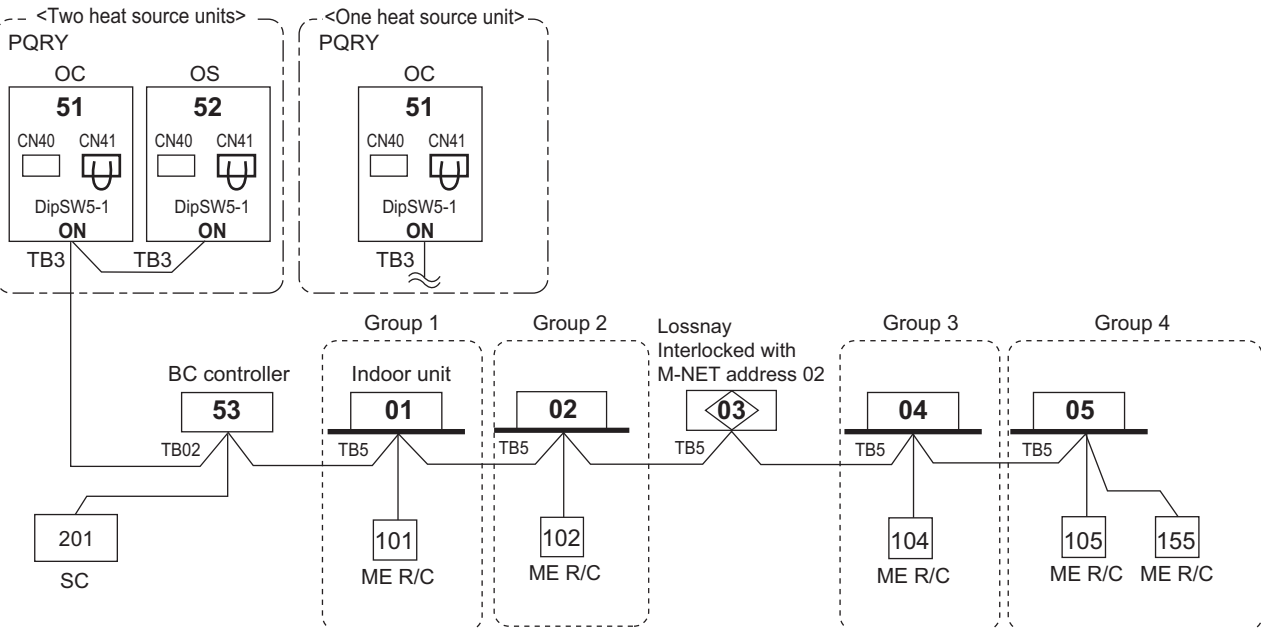

*SC can be connected to TB3 side or TB7 side;
Should SC connected to TB7 side, change Jumper from CN41 to CN40 at the Heat source unit module so as to supply power to the SC.

NOTE:

- Heat source units OC and OS in one refrigerant circuit system are automatically detected. OC and OS are ranked in descending order of capacity. If units are the same capacity, they are ranked in ascending order of their address.
- Address should be set to Indoor units, Lossnay, system controller, and ME remote controllers.
- For a system having more than 32 indoor unit, confirm the need of Booster at 11-3. "System configuration restrictions".
- Indoor units should be set with a branch number.

11-4-3-6. ME remote controller, Multi-refrigerant-system, System Controller at TB7 side, Lossnay, Booster for long M-NET wiring

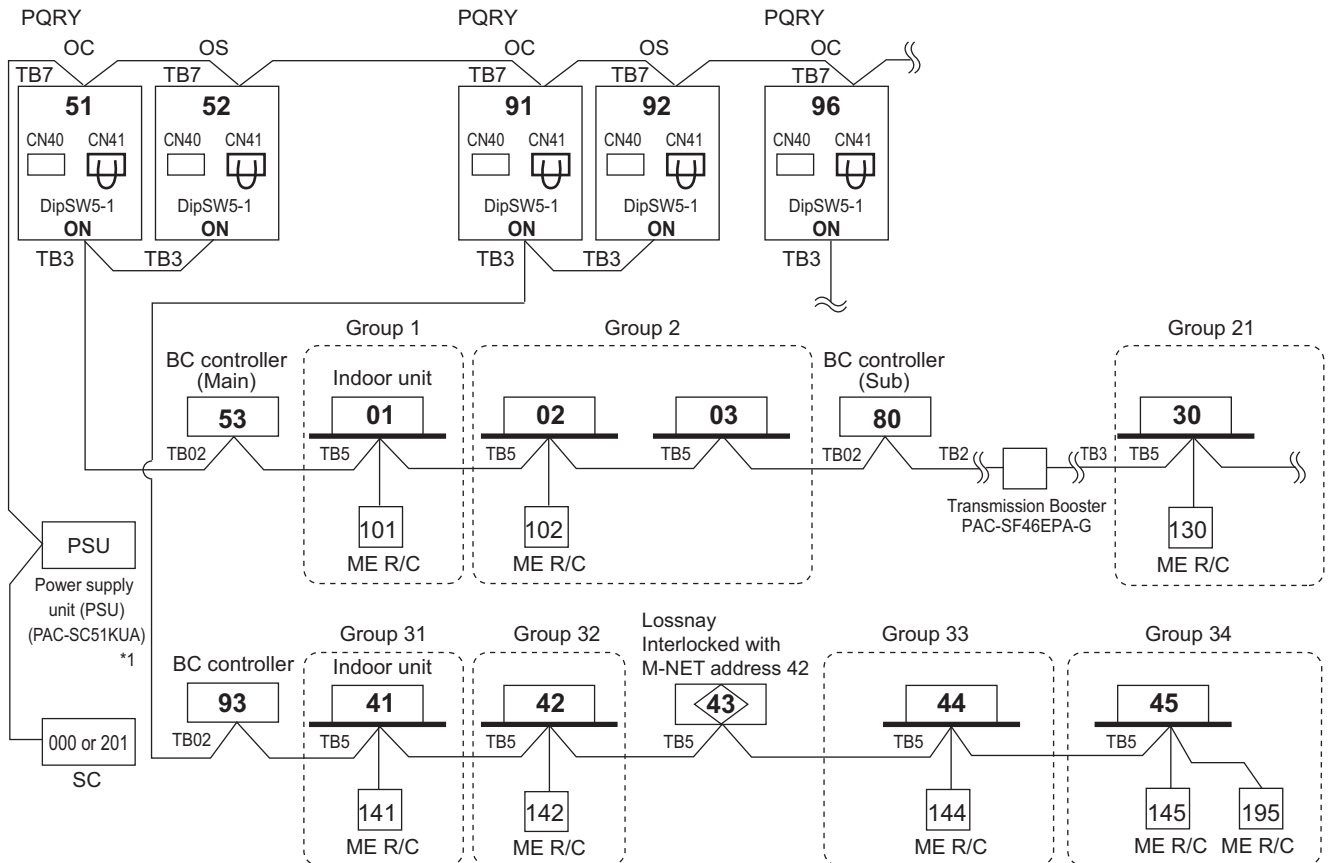

*1 System controller should connect to TB7 at the Heat source unit and use power supply unit together in Multi-Refrigerant-System. For AG-150A-A, 24VDC should be used with the PAC-SC51KUA. For AE-200A, AE-50A, and EW-50A the power supply unit PAC-SC51KUA is unused.

NOTE:

- Heat source units OC and OS in one refrigerant circuit system are automatically detected. OC and OS are ranked in descending order of capacity. If units are the same capacity, they are ranked in ascending order of their address.
- M-NET power is supplied by the Heat source unit at TB3, while Indoor unit and ME R/C consume the M-NET power for transmission use. The power balance is needed to consider for long M-NET wiring. Details refer to 11-3. "System configuration restrictions".
- Indoor units should be set with a branch number.
- Assign an address to each of the sub BC controllers which equals the sum of the smallest address of the indoor units that are connected to each sub BC controller and 50. When the address assigned to sub BC controller overlaps those of any other units including heat source units (OC/OS) or main BC controller, sub BC controller will be given priority to have the address.

11-4-3-7. Example: BC, BC sub

NOTE

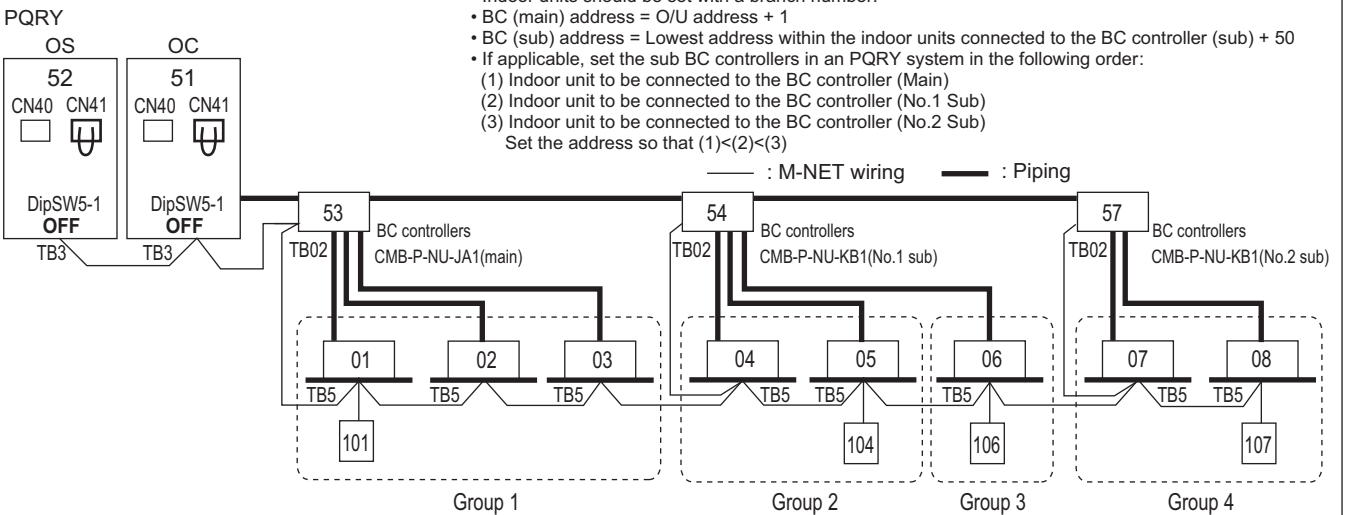

- Indoor units should be set with a branch number.
- BC (main) address = O/U address + 1
- BC (sub) address = Lowest address within the indoor units connected to the BC controller (sub) + 50
- If applicable, set the sub BC controllers in an PQRY system in the following order:
 - Indoor unit to be connected to the BC controller (Main)
 - Indoor unit to be connected to the BC controller (No.1 Sub)
 - Indoor unit to be connected to the BC controller (No.2 Sub)
 Set the address so that (1)<(2)<(3)

PQRY-P-T(S)LMU-A1, Y(S)LMU-A1

11-4-3-8. ME remote controller, Multi-refrigerant-system, No Power supply unit

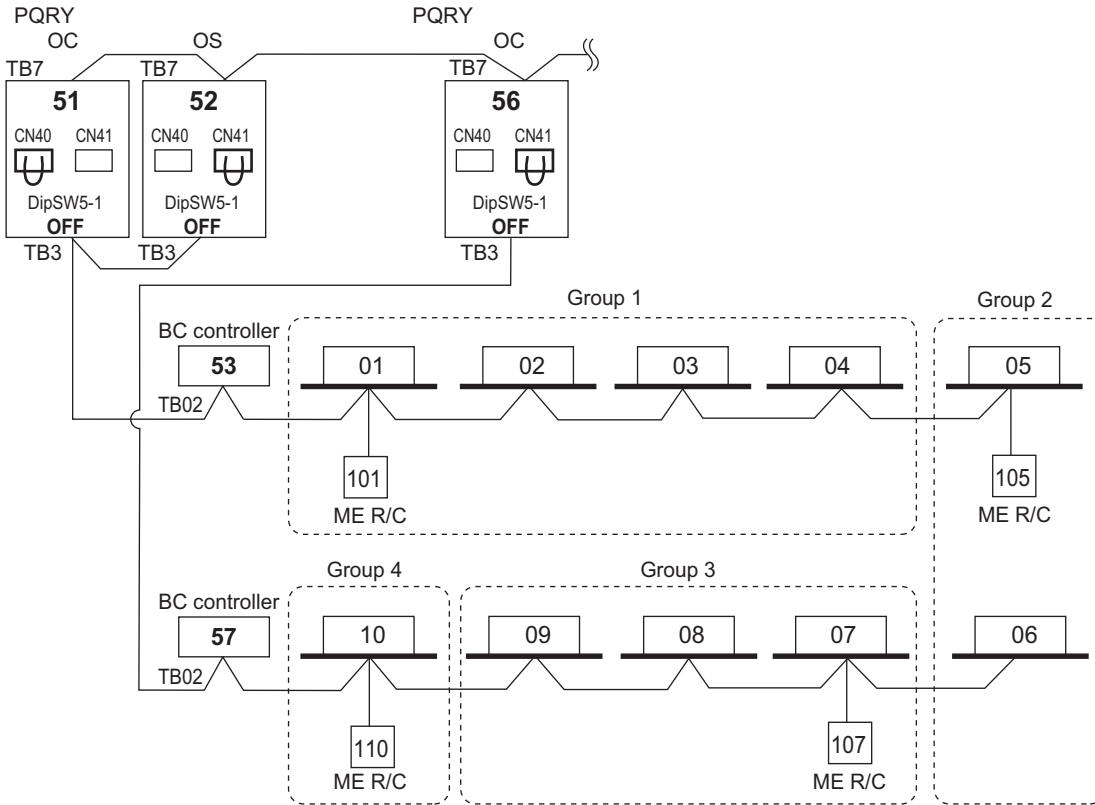

NOTE

- It is necessary to change the connector to CN40 on the heat source unit control board (only one heat source unit) when the group is set between other refrigerant systems.
- It is necessary to set on the remote controller by manual when group sets on the different refrigerant system. Please refer to remote controller installation manual.

11-4-3-9. ME remote controller, Multi-refrigerant-system, System Controller at TB7 side, No Power supply unit

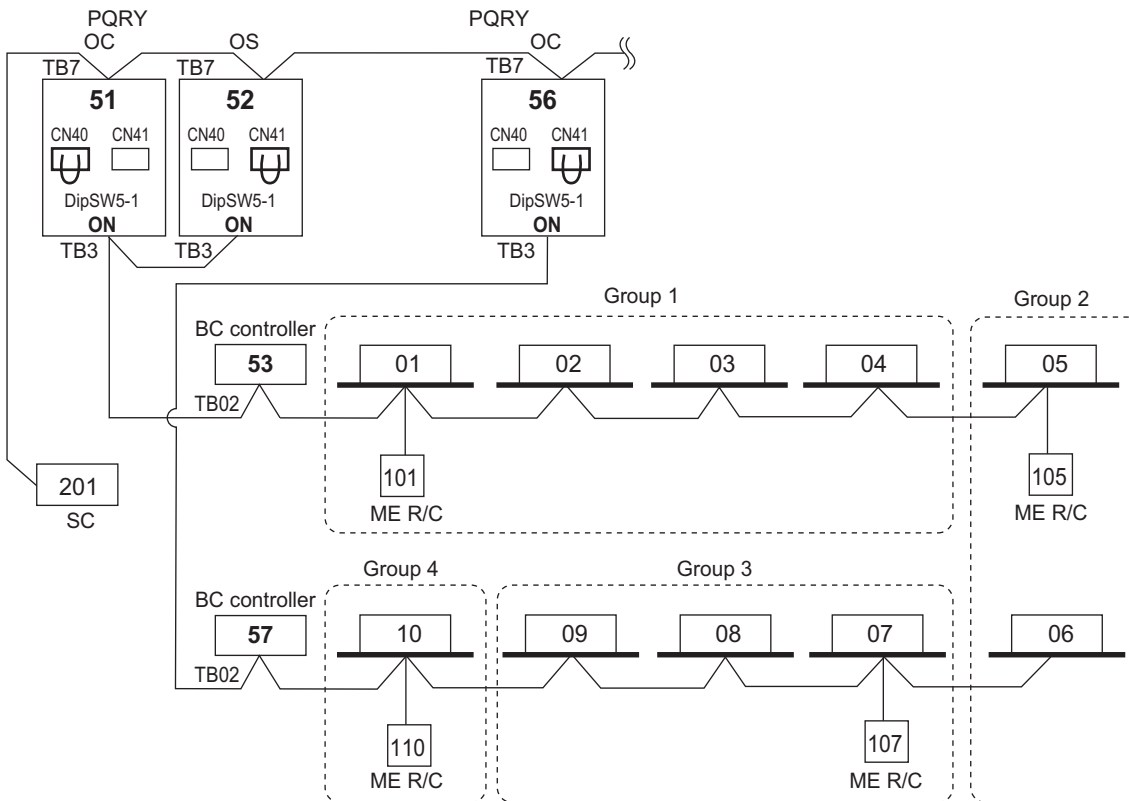

11-4-3-10. AE-200A + AE-50A, EW-50A
 AE-200A can control max. 200 indoor units/via AE-50A.

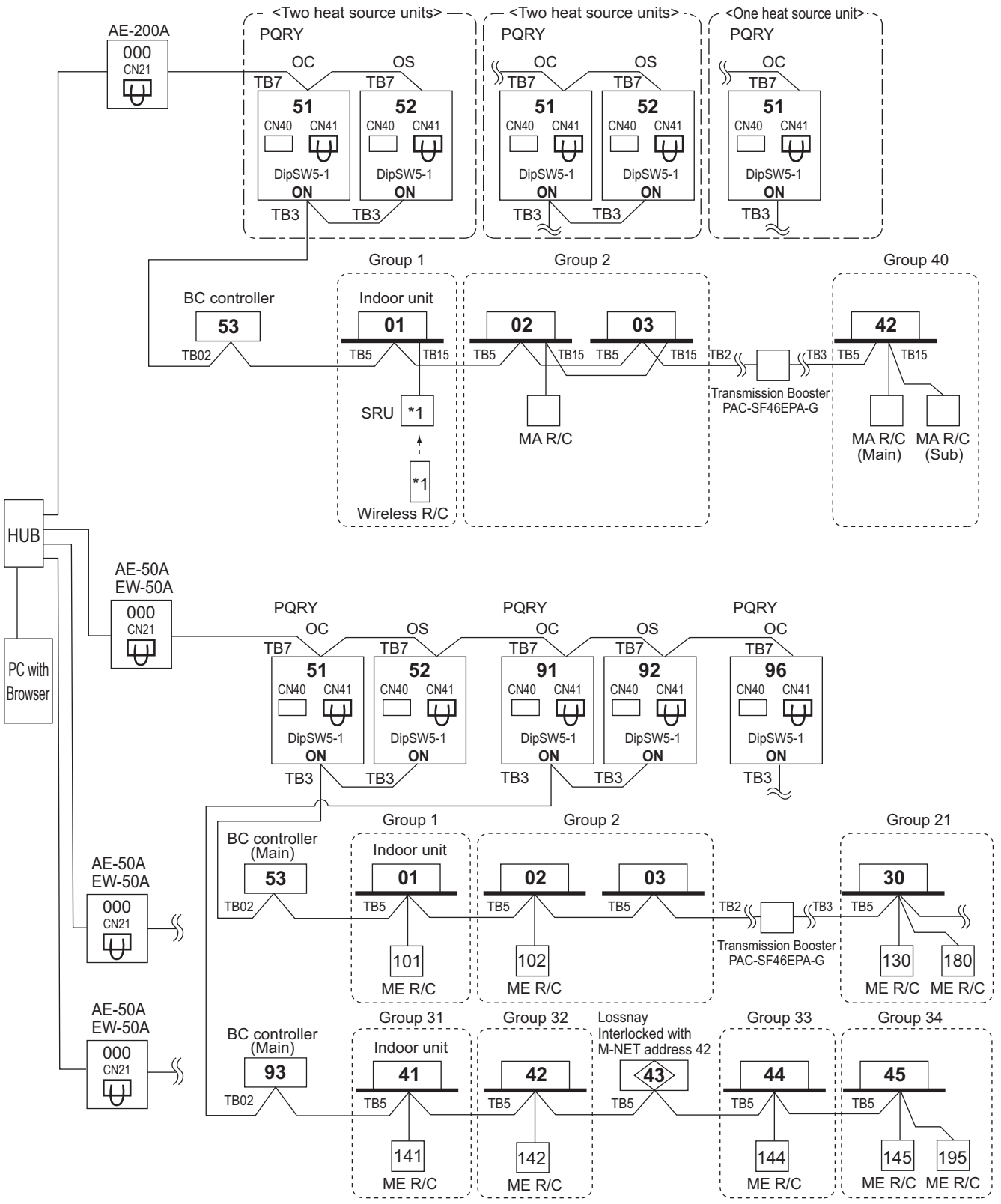

*1 For Wireless R/C and Signal receiver unit (SRU), channel 1, 2 and 3 are selectable and should be set to same channel.
 *2 When a PAR-CT01MAU or PAR-40MAAU is connected to a group, no other MA remote controllers can be connected to the same group.

PQRY-P-T(S)LMU-A1, Y(S)LMU-A1

PQRY-P-T(S)LMU-A1, Y(S)LMU-A1

11-4-3-11. LM-AP

LM-AP can transmit max. 50 indoor units;

If system controller (SC) is used, DipSW1-2 at LM-AP and DipSW5-1 at Heat source unit should set to "ON".

Change Jumper from CN41 to CN40 to activate power supply to LM-AP itself for those LM-AP connected without system controller (SC).

LM-AP can transmit for max.

50 indoor units in single-refrigerant-system or multi-refrigerant-system.

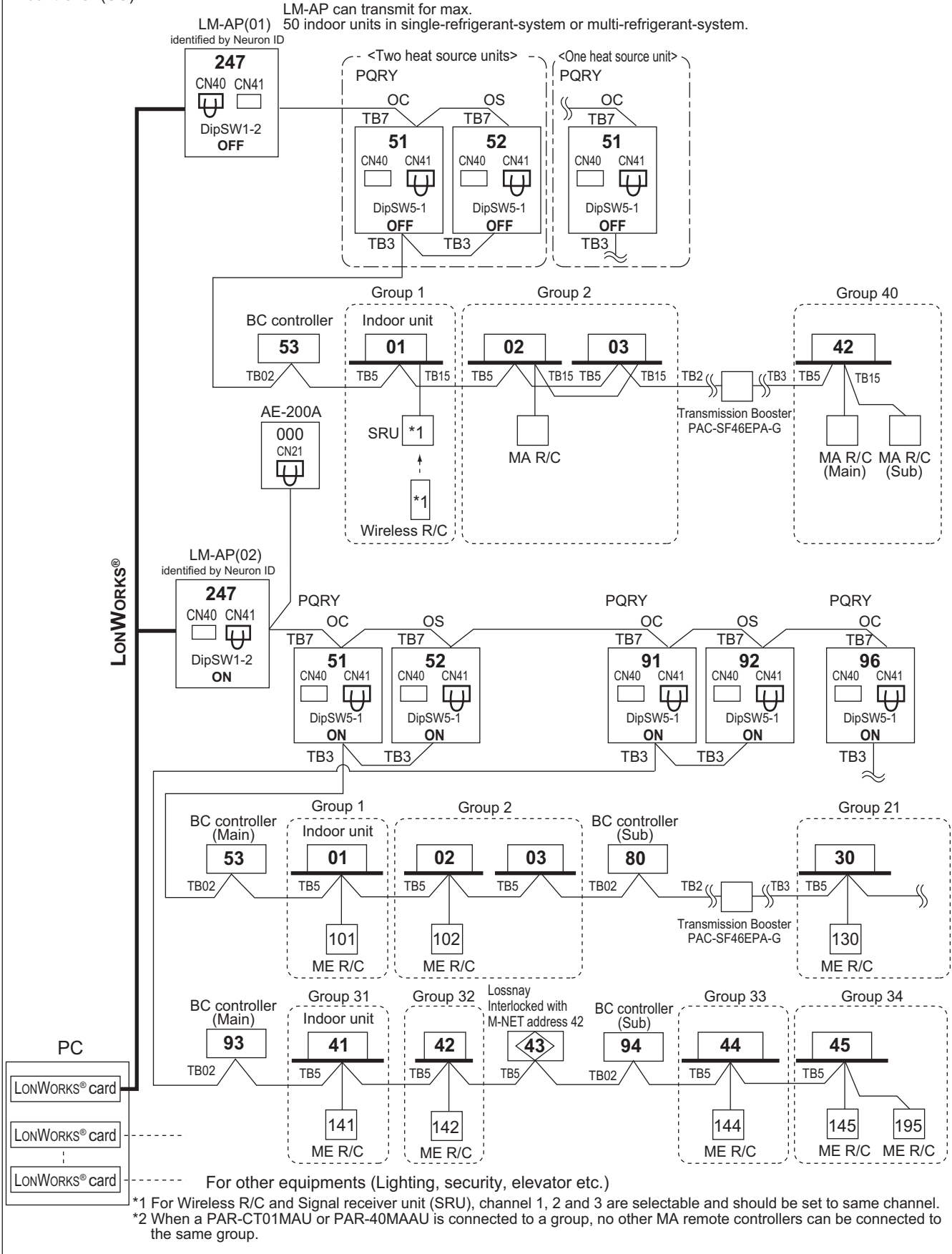

11-4-3-12. BACnet®

EW-50A (AE-200A) can control up to 50 units/groups (including Lossnay).

*To use the BACnet® function on EW-50A (AE-200A), BACnet® license registration is required.

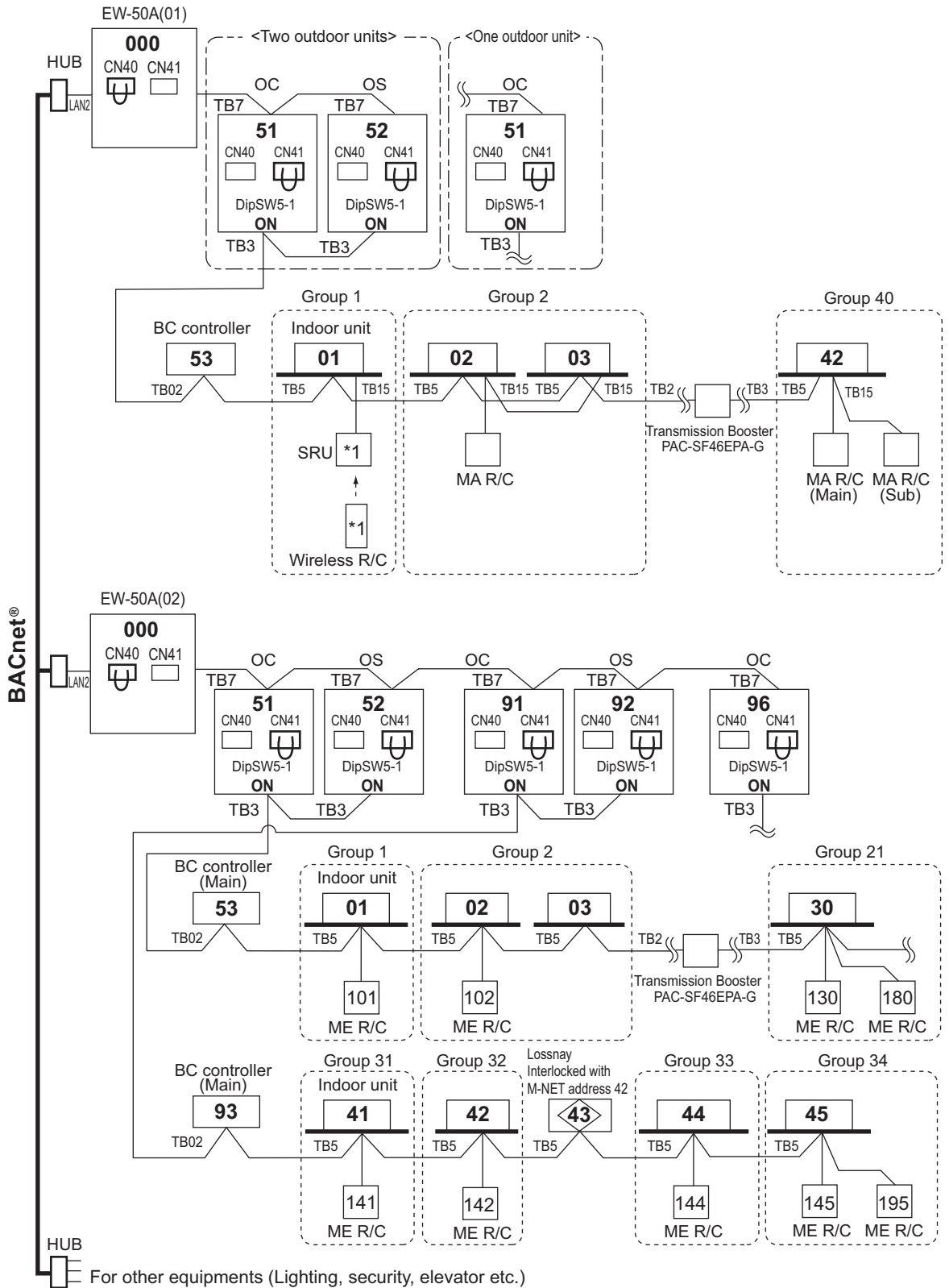

*1 For Wireless R/C and Signal receiver unit (SRU), channel 1, 2 and 3 are selectable and should be set to same channel.

*2 When a PAR-CT01MAU or PAR-40MAAU is connected to a group, no other MA remote controllers can be connected to the same group.

PQR-Y-P-T(S)LMU-A1, Y(S)LMU-A1

12-1. R410A Piping material

The maximum operation pressure of R410A air conditioner is 4.15 MPa [601 psi]. The refrigerant piping should ensure the safety under the maximum operation pressure. You shall follow the local industrial standard.

Procedures for installing the branched pipes

Refer to the instructions that came with the branched pipe kit (separately sold) for details.

[1] Branches on the indoor-unit side

- Restriction on installing the branch joint between BC and indoor units on the gas piping

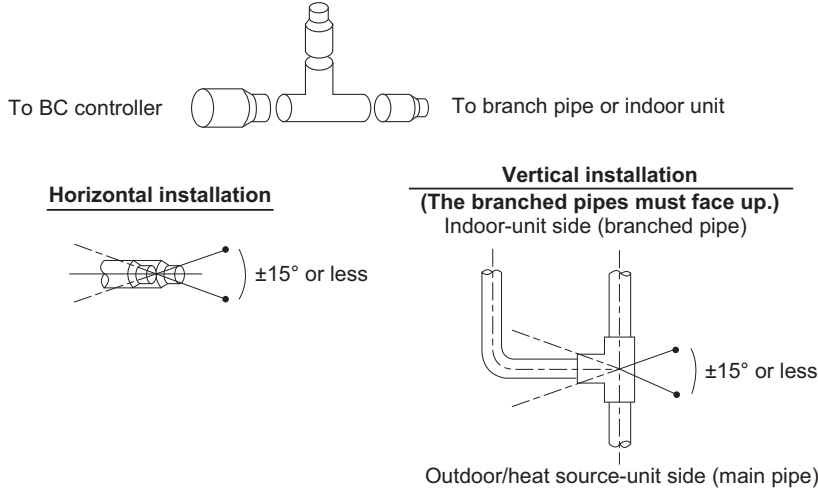

- Branch joint between BC and indoor units in the gas line must be installed horizontally (see figure above) or with the branched pipes facing up.
- If the size of the refrigerant pipe that is selected by following the instructions under "Piping Design" section does not match the size of the joint, use a reducer to connect them. A reducer is included in the kit.
- Restriction on installing the branch joint between Main BC and Sub BC on the high-pressure piping, low-pressure piping, and liquid piping.

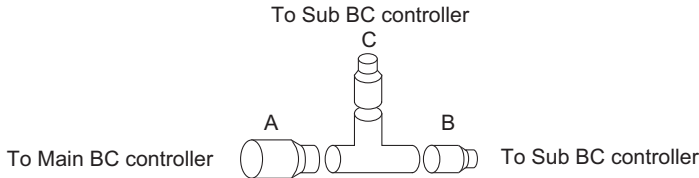

-Regarding the branch joint between Main BC and Sub BC on the high-pressure/low-pressure/liquid piping, A and B must be installed horizontally, and C must be installed upward higher than the horizontal plane of A and B.

[2] Branches on the outdoor/heat source-unit side

Note. Refer to the figure below for the installation position of the twinning pipe.

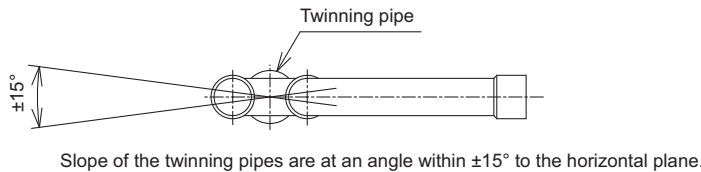

- Inclination of the twinning pipes
The inclination of the twinning pipes must be $\pm 15^\circ$ or less against the horizontal plane.
Excessive inclination of the branched pipes may damage the unit.
- Minimum length of the straight section of the pipe before the branched pipes
Always use the pipes supplied in the branched pipe kit, and make sure the straight section of the pipe immediately before it connects to the branched pipe is at least 500 mm (19-11/16 in.). Failure to do so may damage the unit.

12-2. Piping Design

12-2-1. IF 16 ports or less are in use, i.e., if only one BC controller is in use with no sub BC controller.

"BC controller," "BC controller (Main)," and "BC controller (Sub)" that appear in this section refer to the J1-type, JA1/KA1 type, and KB1 type.

When mixing GA1/HA1/GB1/HB1 type and JA1/KA1/KB1 type, specifications and restrictions is according to GA1/HA1/GB1/HB1 type. (piping length, connectable number of Sub BC)

- Note1. No Header usable on PQRY system.
- Note2. Indoor unit sized P72-P96 should be connected to BC controller via Y shape joint CMY-R160-J1.
- Note3. Indoor unit sized P72-P96 does NOT share BC controller ports with other Indoor units ;
- Note4. As bents cause pressure loss on transportation of refrigerant, fewer bents design is better ; Piping length needs to consider the actual length and equivalent length which bents are counted. Equivalent piping length (m)=Actual piping length+"M" x Number of bent.
- Note5. Set DIP-SW 4-6 to ON of BC controller, in case of connected Indoor unit sized P72-P96 with 2 ports.
- Note6. Do not connect multiple indoor units to the same port when operating each of them in different mod (cooling, heating, stop, and thermo-off). The indoor units connected to the same port must be set to operate in the same mode. Set them in the same group to make them run/stop in the same mode all together. For other options, enable the thermo setting on the remote controller, or set the common thermostat (optional) to run/stop the units in the same mode based on a representative temperature.
- Note7. Indoor capacity is described as its model size. For example, PEFY-P24NMAU-E3, its capacity is P24.
- Note8. Total down-stream Indoor capacity is the summary of the model size of Indoors down-stream. For example, PEFY-P24NMAU-E3 + PEFY-P06NMAU-E3: Total Indoor capacity = P24 + P06 = P30.
- Note9. To connect the BC controller to the main pipe, use the reducer (CMY-R301S-G, CMY-R302S-G1, or CMY-R304S-G1).
- Note10. Install the pipes correctly referring to the section titled "Procedures for installing the branched pipes."

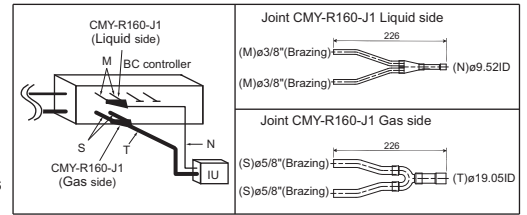

Fig. 12-2-1AA

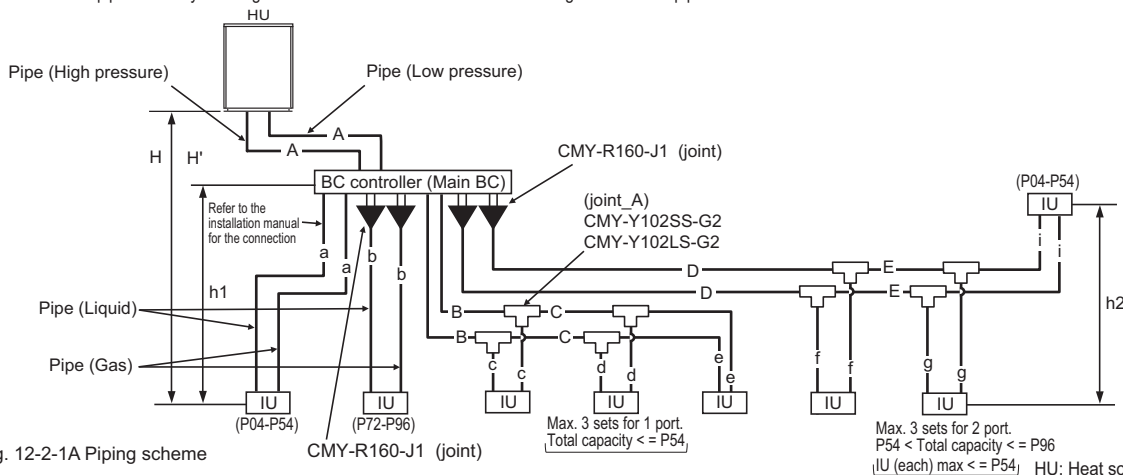

Fig. 12-2-1A Piping scheme

Piping length limitation *6		(m [ft.])	
Item	Piping in the figure	Max. length	Max. equivalent length
Total piping length (Total length of high pressure and liquid pipes)	A+B+C+D+E+a+b+c+d+e+f+g+i	*1	-
Farthest IU from HU	A+D+E+i	165 [541']	190 [623']
Distance between HU and BC	A	110 [360']	110 [360'] *1
Farthest IU from BC controller	D+E+i	60 [197'] *2*3	60 [197'] *2*3
Height between HU and IU (HU above IU)	H	50 [164']	-
Height between HU and IU (HU under IU)	H'	40 [131']	-
Height between IU and BC	h1	15 [49'] (10 [32']) *4	-
Height between IU and IU	h2	30 [98'] (20 [65']) *5	-

Max. 3 sets for 1 port. Total capacity <= P54
 Max. 3 sets for 2 port. P54 < Total capacity <= P96
 (IU each) max <= P54; HU: Heat source unit, IU: Indoor unit

Bent equivalent length		
Heat source Model	M (m/bent)	[ft./bent]
P72TLMU, YLMU	0.35	[1.15']
P96TLMU, YLMU	0.42	[1.38']
P120TLMU, YLMU	0.47	[1.54']
P144TLMU, YLMU	0.50	[1.64']
P168TLMU, YLMU	0.50	[1.64']
P192TLMU, YLMU	0.50	[1.64']
P216TLMU, YLMU	0.50	[1.64']
P240TLMU, YLMU	0.50	[1.64']

HU: Heat source Unit; IU: Indoor Unit; BC: BC controller

- *1. Refer to the section 12-2-4.
- *2. Details refer to Fig. 1.
- *3. When the P72 or P96 model of indoor units are connected to the system, the maximum distance from the BC controller to the farthest indoor unit indicated as "D + E + i" in the figure is 40 meters.
- *4. Distance of Indoor sized P72, P96 from BC must be less than 10 m, if any.
- *5. Distance of Indoor sized P72, P96 from IU must be less than 20 m, if any.
- *6. Total length of high-pressure pipes and liquid pipes

Fig. 1 Piping length and height between IU and BC controller

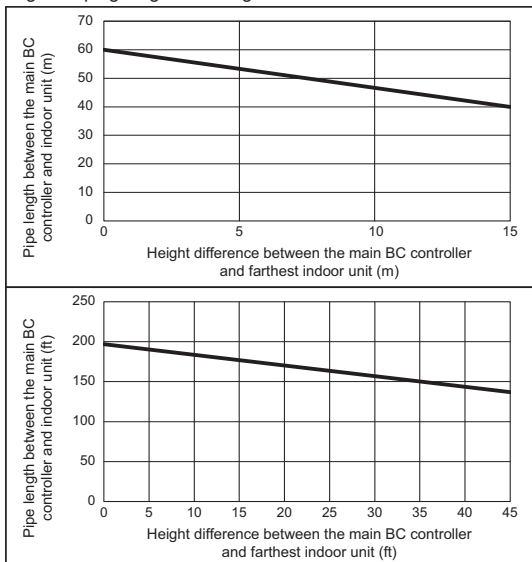

Piping "A" size selection rule (mm [in.])		
Heat source Model	Pipe(High pressure)	Pipe(Low pressure)
P72TLMU, YLMU	ø15.88 [5/8"]	ø19.05 [3/4"]
P96-120TLMU, YLMU	ø19.05 [3/4"]	ø22.20 [7/8"]
P144-192TLMU, YLMU	ø22.20 [7/8"]	ø28.58 [1-1/8"]
P216TLMU, YLMU	ø22.20 [7/8"] *9	ø28.58 [1-1/8"]
P240TLMU, YLMU	ø22.20 [7/8"] *9	ø34.93 [1-3/8"]

*9. When the piping length is 65 m or longer, use the ø28.58 [1-1/8"] pipe for the part that exceeds 65 m.

Piping "B", "C", "D", "E" size selection rule (mm [in.])		
Total down-stream Indoor capacity	Pipe(Liquid)	Pipe(Gas)
P54 or less	ø9.52 [3/8"]	ø15.88 [5/8"]
P55-P72	ø9.52 [3/8"]	ø19.05 [3/4"]
P73-P96	ø9.52 [3/8"]	ø22.20 [7/8"]

Piping "a", "b", "c", "d", "e", "f", "g", "i" size selection rule (mm [in.])		
Indoor Unit size	Pipe(Liquid)	Pipe(Gas)
P04-P18	ø6.35 [1/4"]	ø12.70 [1/2"]
P24-P54	ø9.52 [3/8"]	ø15.88 [5/8"]
P72	ø9.52 [3/8"]	ø19.05 [3/4"]
P96	ø9.52 [3/8"]	ø22.20 [7/8"]

Selection criteria for joints_A	
Total down-stream Indoor capacity	Joint
-P72	CMY-Y102SS-G2
P73-P96	CMY-Y102LS-G2

PQRY-P-T(S)LMU-A1, Y(S)LMU-A1

12-2-2. IF more than 16 ports are in use, or if there is more than one BC controller in use for one Heat source unit

- Note1. No Header usable on PQRY system.
- Note2. Indoor unit sized P72-P96 should be connected to BC controller via Y shape joint CMY-R160-J1.
- Note3. Indoor unit sized P72-P96 does NOT share BC controller ports with other Indoor units ;
- Note4. As bents cause pressure loss on transportation of refrigerant, fewer bents design is better ;
Piping length needs to consider the actual length and equivalent length which bents are counted.
Equivalent piping length (m)=Actual piping length+“M” x Number of bent.
- Note5. Set DIP-SW 4-6 to ON of BC controller, in case of connected Indoor unit sized P72-P96 with 2 ports.
- Note6. Do not connect multiple indoor units to the same port when operating each of them in different mode (cooling, heating, stop, and thermo-off). The indoor units connected to the same port must be set to operate in the same mode. Set them in the same group to make them run/stop in the same mode all together. For other options, enable the thermo setting on the remote controller, or set the common thermostat (optional) to run/stop the units in the same mode based on a representative temperature.
- Note7. The maximum total capacity of indoor units that can be connected to each sub BC controller CMB-P-NU-KB1 is 126.
- Note8. Indoor capacity is described as its model size. For example, PEFY-P24NMAU-E3, its capacity is P24.
- Note9. Total down-stream Indoor capacity is the summary of the model size of Indoors down-stream. For example, PEFY-P24NMAU-E3 + PEFY-P06NMAU-E3 : Total Indoor capacity = P24 + P06 = P30.
- Note10. To connect the BC controller to the main pipe, use the reducer (CMY-R301S-G, CMY-R302S-G1, or CMY-R304S-G1).
- Note11. To connect the sub BC controller to the main BC controller, use the reducer (CMY-R303S-G1, CMY-R305S-G1, or CMY-R306S-G).
- Note12. Install the pipes correctly referring to the section titled "Procedures for installing the branched pipes."
- Note13. Up to 11 sub BC controllers can be connected.

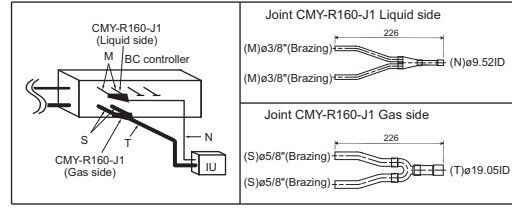

Fig. 12-2-2AA

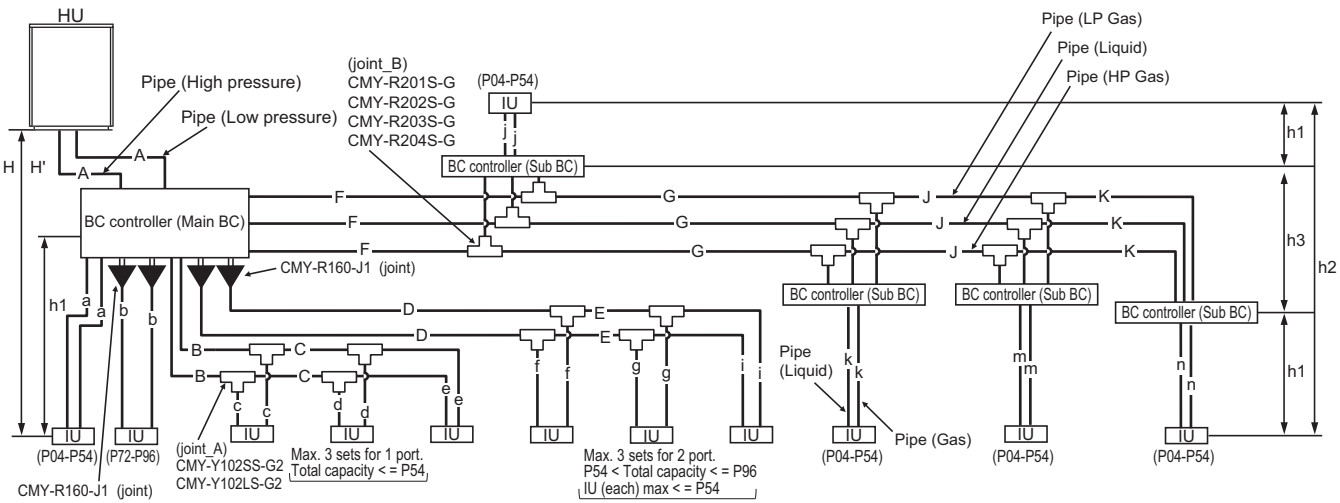

Fig. 12-2-2A Piping scheme

HU: Heat source unit, IU: Indoor unit

Piping length limitation *8

Item	Piping in the figure	Max. length	Max. equivalent length (m [ft.])
Total piping length (Total length of high pressure and liquid pipes)	A+B+C+D+E+F+G+J+K+a+b+c+d+e+f+g+i+j+k+m+n	*1	-
Farthest IU from HU	A+F+G+J+K+n	165 [541']	190 [623']
Distance between HU and BC	A	110 [360'] *1	110 [360'] *1
Farthest IU from BC controller	D+E+i	60 [197'] *2*3	60 [197'] *2*3
Farthest IU from BC controller via Sub BC controller	F+G+J+K+n	90 [295'] *7	90 [295'] *7
Height between HU and IU (HU above IU)	H	50 [164']	-
Height between HU and IU (HU under IU)	H'	40 [131']	-
Height between IU and BC	h1	15 [49'] (10 [32']) *4	-
Height between IU and IU	h2	30 [98'] (20 [65']) *5	-
Height between BC(Main or Sub) and BC(Sub)	h3	15 [49'] (10 [32']) *6	-

HU: Heat source Unit; IU: Indoor Unit; BC: BC controller

- *1. Refer to the section 12-2-4.
- *2. Details refer to Fig. 2.
- *3. When the P72 or P96 model of indoor units are connected to the system, the maximum distance from the BC controller to the farthest indoor unit indicated as "D + E + i" in the figure is 40 meters.
- *4. Distance of Indoor sized P72, P96 from BC must be less than 10 m, if any.
- *5. Distance of Indoor sized P72, P96 from IU must be less than 20 m, if any.
- *6. When using 2 or more Sub BC controllers, max. height "h3" should be considered.
- *7. When the piping length or the vertical separation exceeds the limit specified in Fig. 2, connect a sub BC to the system. The restriction for a system with a sub BC connection is shown in Fig. 3. When a given system configuration falls within the shaded area in Fig. 3, increase the size of the high-pressure pipe and the liquid pipe between the main BC and sub BC by one size. When using P12, P15, P18, P36, or P48 model of indoor units, increase the size of the liquid branch pipe between the sub BC and indoor unit by one size. When using indoor models P54 or larger, the restrictions shown in Fig. 2 cannot be exceeded.
- *8. Total length of high-pressure pipes and liquid pipes

Bent equivalent length

Heat source Model	M (m/bent [ft./bent])
P72TLMU, YLMU	0.35 [1.15']
P96TLMU, YLMU	0.42 [1.38']
P120TLMU, YLMU	0.47 [1.54']
P144TLMU, YLMU	0.50 [1.64']
P168TLMU, YLMU	0.50 [1.64']
P192TLMU, YLMU	0.50 [1.64']
P216TLMU, YLMU	0.50 [1.64']
P240TLMU, YLMU	0.50 [1.64']

Piping length and height between IU and BC controller

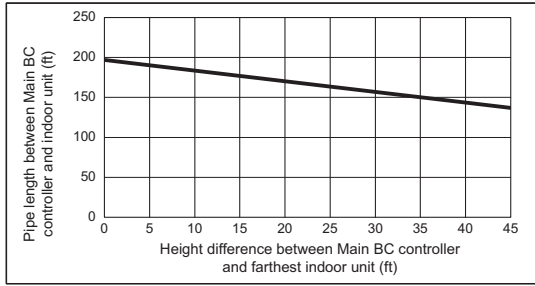

Fig. 2

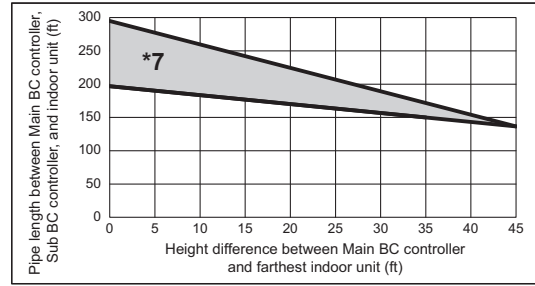
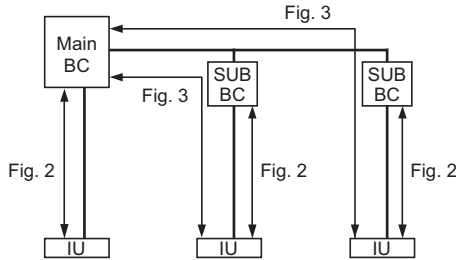

Fig. 3



*7. When the piping length or the vertical separation exceeds the limit specified in Fig. 2, connect a sub BC to the system.

The restriction for a system with a sub BC connection is shown in Fig. 3. When a given system configuration falls within the shaded area in Fig. 3, increase the size of the high-pressure pipe and the liquid pipe between the main BC and sub BC by one size. The maximum liquid branch pipe diameter is $\phi 19.05$. If a given system already has a $\phi 19.05$ -pipe between the main BC and sub BC, there is no need to increase the pipe size. When using P12, P15, P18, P36, or P48 model of indoor units, increase the size of the liquid branch pipe between the sub BC and indoor unit by one size. When using indoor models P54 or larger, the restrictions shown in Fig. 2 cannot be exceeded.

Piping "A" size selection rule

(mm [in.])

Heat source Model	Pipe(High pressure)	Pipe(Low pressure)
P72TLMU, YLMU	$\phi 15.88$ [5/8"]	$\phi 19.05$ [3/4"]
P96-120TLMU, YLMU	$\phi 19.05$ [3/4"]	$\phi 22.20$ [7/8"]
P144-192TLMU, YLMU	$\phi 22.20$ [7/8"]	$\phi 28.58$ [1-1/8"]
P216TLMU, YLMU	$\phi 22.20$ [7/8"] *9	$\phi 28.58$ [1-1/8"]
P240TLMU, YLMU	$\phi 22.20$ [7/8"] *9	$\phi 34.93$ [1-3/8"]

*9. When the piping length is 65 m or longer, use the $\phi 28.58$ [1-1/8"] pipe for the part that exceeds 65 m.

Selection criteria for joints_A

Total down-stream Indoor capacity	Joint
-P72	CMY-Y102SS-G2
P73-P96	CMY-Y102LS-G2

Piping "B", "C", "D", "E" size selection rule

(mm [in.])

Total down-stream Indoor capacity	Pipe(Liquid)	Pipe(Gas)
P54 or less	$\phi 9.52$ [3/8"]	$\phi 15.88$ [5/8"]
P55-P72	$\phi 9.52$ [3/8"]	$\phi 19.05$ [3/4"]
P73-P96	$\phi 9.52$ [3/8"]	$\phi 22.20$ [7/8"]

Selection criteria for joints_B

Total down-stream Indoor capacity	Joint
-P126	CMY-R201S-G
P127-P216	CMY-R202S-G
P217-P234	CMY-R203S-G
P235-P360	CMY-R204S-G

Piping "a", "b", "c", "d", "e", "f", "g", "i", "j", "k", "m", "n" size selection rule (mm [in.])

Indoor Unit size	Pipe(Liquid)	Pipe(Gas)
P04-P18	$\phi 6.35$ [1/4"]	$\phi 12.70$ [1/2"]
P24-P54	$\phi 9.52$ [3/8"]	$\phi 15.88$ [5/8"]
P72	$\phi 9.52$ [3/8"]	$\phi 19.05$ [3/4"]
P96	$\phi 9.52$ [3/8"]	$\phi 22.20$ [7/8"]

Piping "F", "G", "J", "K" size selection rule

(mm [in.])

Total down-stream Indoor capacity	Pipe(Liquid)	Pipe(HP Gas)	Pipe(LP Gas)
P72 or less	$\phi 9.52$ [3/8"]	$\phi 15.88$ [5/8"]	$\phi 19.05$ [3/4"]
P73 to P108	$\phi 9.52$ [3/8"]	$\phi 19.05$ [3/4"]	$\phi 22.20$ [7/8"]
P109 to P126	$\phi 12.70$ [1/2"]	$\phi 19.05$ [3/4"]	$\phi 28.58$ [1-1/8"]
P127 to P144	$\phi 12.70$ [1/2"]	$\phi 22.20$ [7/8"]	$\phi 28.58$ [1-1/8"]
P145 to P216	$\phi 15.88$ [5/8"]	$\phi 22.20$ [7/8"]	$\phi 28.58$ [1-1/8"]
P217 to P234	$\phi 15.88$ [5/8"]	$\phi 28.58$ [1-1/8"]	$\phi 28.58$ [1-1/8"]
P235 to P288	$\phi 19.05$ [3/4"]	$\phi 28.58$ [1-1/8"]	$\phi 34.93$ [1-3/8"]
P289 or above	$\phi 19.05$ [3/4"]	$\phi 28.58$ [1-1/8"]	$\phi 41.28$ [1-5/8"]

HP: High pressure, LP: Low pressure

PQRY-P-T(S)LMU-A1, Y(S)LMU-A1

12-2-3. IF more than 16 ports are in use, or if there is more than one BC controller in use for two Heat source units

- Note1. No Header usable on PQRY system.
- Note2. Indoor unit sized P72-P96 should be connected to BC controller via Y shape joint CMY-R160-J1.
- Note3. Indoor unit sized P72-P96 does NOT share BC controller ports with other Indoor units ;
- Note4. As bents cause pressure loss on transportation of refrigerant, fewer bents design is better ; Piping length needs to consider the actual length and equivalent length which bents are counted. Equivalent piping length (m)=Actual piping length+"M" x Number of bent.
- Note5. Set DIP-SW 4-6 to ON of BC controller, in case of connected Indoor unit sized P72-P96 with 2 ports.
- Note6. Do not connect multiple indoor units to the same port when operating each of them in different mode (cooling, heating, stop, and thermo-off). The indoor units connected to the same port must be set to operate in the same mode. Set them in the same group to make them run/stop in the same mode all together. For other options, enable the thermo setting on the remote controller, or set the common thermostat (optional) to run/stop the units in the same mode based on a representative temperature.
- Note7. The maximum total capacity of indoor units that can be connected to each sub BC controller CMB-P-NU-KB1 is P126.
- Note8. Indoor capacity is described as its model size. For example, PEFY-P24NMAU-E3, its capacity is P24.
- Note9. Total down-stream Indoor capacity is the summary of the model size of Indoors down-stream. For example, PEFY-P24NMAU-E3 + PEFY-P06NMAU-E3 : Total Indoor capacity = P24 + P06 = P30.
- Note10. To connect the BC controller to the main pipe, use the reducer (CMY-R301S-G, CMY-R302S-G1, or CMY-R304S-G1).
- Note11. To connect the sub BC controller to the main BC controller, use the reducer (CMY-R303S-G1, CMY-R305S-G1, or CMY-R306S-G).
- Note12. Install the pipes correctly referring to the section titled "Procedures for installing the branched pipes."
- Note13. Up to 11 sub BC controllers can be connected.

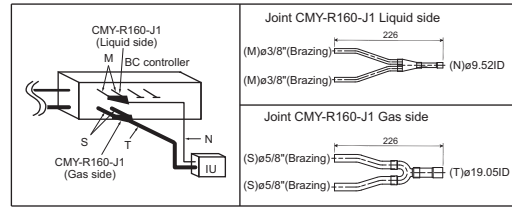
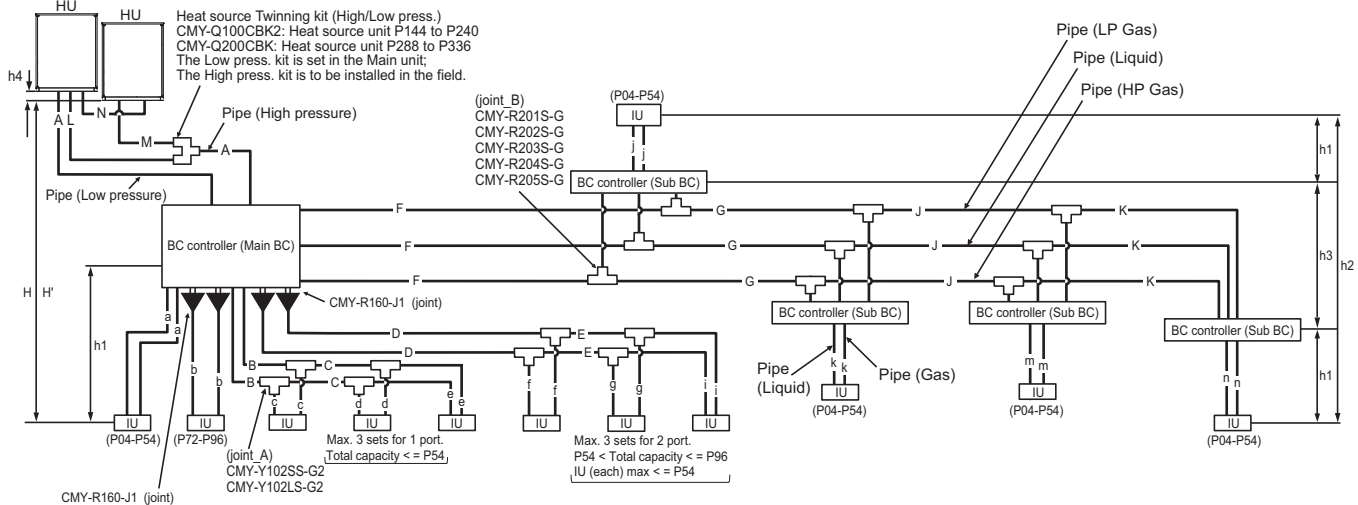

Fig. 12-2-3AA



HU: Heat source unit, IU: Indoor unit

Piping length limitation *9

Item	Piping in the figure	Max. length	Max. equivalent length (m [ft.])
Total piping length (Total length of high pressure and liquid pipes)	L+M+A+B+C+D+E+F+G+J+K+a+b+c+d+e+f+g+h+i+j+k+m+n	*1	-
Farthest IU from HU	L(M)+A+F+G+J+K+n	165 [541']	190 [623']
Distance between HU and BC	L(M)+A	110 [360'] *1	110 [360'] *1
Farthest IU from BC controller	D+E+i	60 [197'] *2 *3	60 [197'] *2*3
Farthest IU from BC controller via Sub BC controller	F+G+J+K+n	90 [295'] *7	90 [295'] *7
Height between HU and IU (HU above IU)	H	50 [164']	-
Height between HU and IU (HU under IU)	H'	40 [131']	-
Height between IU and BC	h1	15 [49'] (10 [32']) *4	-
Height between IU and IU	h2	30 [98'] (20 [65']) *5	-
Height between BC(Main or Sub) and BC(Sub)	h3	15 [49'] (10 [32']) *6	-
Distance between Main unit and Sub unit	L+M or N	5 [16']	-
Height between Main unit and Sub unit	h4	0.1 [0.3']	-

HU: Heat source Unit; IU: Indoor Unit; BC: BC controller

- *1. Refer to the section 12-2-4.
- *2. Details refer to Fig. 2.
- *3. When the P72 or P96 model of indoor units are connected to the system, the maximum distance from the BC controller to the farthest indoor unit (indicated as "D + E + i" in the figure is 40 meters.)
- *4. Distance of Indoor sized P72, P96 from BC must be less than 10 m, if any.
- *5. Distance of Indoor sized P72, P96 from IU must be less than 20 m, if any.
- *6. When using 2 or more Sub BC controllers, max. height "h3" should be considered.
- *7. When the piping length or the vertical separation exceeds the limit specified in Fig. 2, connect a sub BC to the system. The restriction for a system with a sub BC connection is shown in Fig. 3. When a given system configuration falls within the shaded area in Fig. 3, increase the size of the high-pressure pipe and the liquid pipe between the main BC and sub BC by one size. When using P12, P15, P18, P36, or P48 model of indoor units, increase the size of the liquid branch pipe between the sub BC and indoor unit by one size. When using indoor models P54 or larger, the restrictions shown in Fig. 2 cannot be exceeded.
- *8. When the high pressure piping length is 65 m or less, use ø22.2 (ø7/8) pipe. When the high pressure piping length exceeds 65 m, use ø22.2 (ø7/8) pipe until 65 m, use ø28.58 (ø1-1/8) pipe for the part that exceeds 65 m.
- *9. Total length of high-pressure pipes and liquid pipes

Bent equivalent length

Heat source Model	M (m/bent [ft./bent])
P144TSLMU, YSLMU	0.50 [1.64']
P168TSLMU, YSLMU	0.50 [1.64']
P192TSLMU, YSLMU	0.50 [1.64']
P216TSLMU, YSLMU	0.50 [1.64']
P240TSLMU, YSLMU	0.50 [1.64']
P288TSLMU, YSLMU	0.70 [2.29']
P312TSLMU, YSLMU	0.70 [2.29']
P336TSLMU, YSLMU	0.80 [2.62']

Piping length and height between IU and BC controller

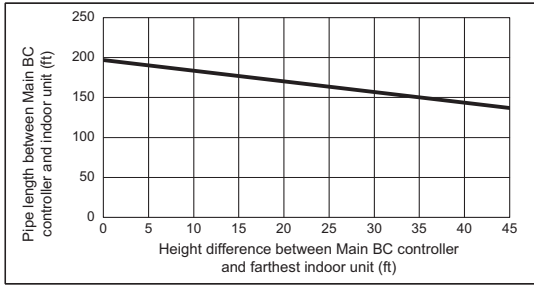

Fig. 2

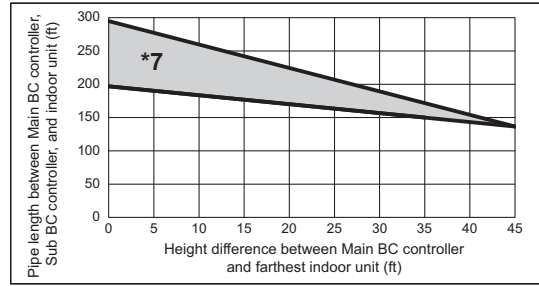
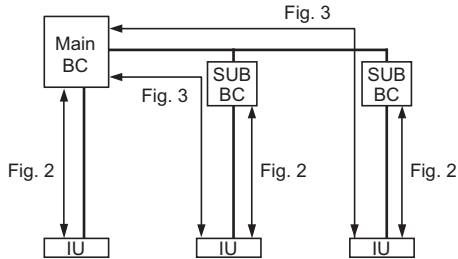

Fig. 3



*7. When the piping length or the vertical separation exceeds the limit specified in Fig. 2, connect a sub BC to the system.
 The restriction for a system with a sub BC connection is shown in Fig. 3.
 When a given system configuration falls within the shaded area in Fig. 3, increase the size of the high-pressure pipe and the liquid pipe between the main BC and sub BC by one size.
 The maximum liquid branch pipe diameter is $\phi 19.05$. If a given system already has a $\phi 19.05$ -pipe between the main BC and sub BC, there is no need to increase the pipe size.
 When using P12, P15, P18, P36, or P48 model of indoor units, increase the size of the liquid branch pipe between the sub BC and indoor unit by one size.
 When using indoor models P54 or larger, the restrictions shown in Fig. 2 cannot be exceeded.

Piping "A" size selection rule

(mm [in.])

Heat source Model	Pipe(High pressure)	Pipe(Low pressure)
P144-192TSLMU, YSLMU	$\phi 22.20$ [7/8"]	$\phi 28.58$ [1-1/8"]
P216TSLMU, YSLMU	$\phi 22.20$ [7/8"] *10	$\phi 28.58$ [1-1/8"]
P240TSLMU, YSLMU	$\phi 22.20$ [7/8"] *10	$\phi 34.93$ [1-3/8"]
P288-312TSLMU, YSLMU	$\phi 28.58$ [1-1/8"]	$\phi 34.93$ [1-3/8"]
P336TSLMU, YSLMU	$\phi 28.58$ [1-1/8"]	$\phi 41.28$ [1-5/8"]

*10. When the piping length is 65 m or longer, use the $\phi 28.58$ [1-1/8"] pipe for the part that exceeds 65 m.

Piping "L", "M", "N" size selection rule

(mm [in.])

Heat source Model	Pipe(High pressure)	Pipe(Low pressure)
P72TLMU, YLMU	$\phi 15.88$ [5/8"]	$\phi 19.05$ [3/4"]
P96TLMU, YLMU	$\phi 19.05$ [3/4"]	$\phi 22.20$ [7/8"]
P120TLMU, YLMU	$\phi 19.05$ [3/4"]	$\phi 22.20$ [7/8"]
P144TLMU, YLMU	$\phi 22.20$ [7/8"]	$\phi 28.58$ [1-1/8"]
P168TLMU, YLMU	$\phi 22.20$ [7/8"]	$\phi 28.58$ [1-1/8"]

Piping "B", "C", "D", "E" size selection rule

(mm [in.])

Total down-stream Indoor capacity	Pipe(Liquid)	Pipe(Gas)
P54 or less	$\phi 9.52$ [3/8"]	$\phi 15.88$ [5/8"]
P55-P72	$\phi 9.52$ [3/8"]	$\phi 19.05$ [3/4"]
P73-P96	$\phi 9.52$ [3/8"]	$\phi 22.20$ [7/8"]

Selection criteria for joints A

Total down-stream Indoor capacity	Joint
-P72	CMY-Y102SS-G2
P73-P96	CMY-Y102LS-G2

Piping "a", "b", "c", "d", "e", "f", "g", "i", "j", "k", "m", "n" size selection rule

(mm [in.])

Indoor Unit size	Pipe(Liquid)	Pipe(Gas)
P04-P18	$\phi 6.35$ [1/4"]	$\phi 12.70$ [1/2"]
P24-P54	$\phi 9.52$ [3/8"]	$\phi 15.88$ [5/8"]
P72	$\phi 9.52$ [3/8"]	$\phi 19.05$ [3/4"]
P96	$\phi 9.52$ [3/8"]	$\phi 22.20$ [7/8"]

Selection criteria for joints B

Total down-stream Indoor capacity	Joint
-P126	CMY-R201S-G
P127-P216	CMY-R202S-G
P217-P234	CMY-R203S-G
P235-P360	CMY-R204S-G
P361-	CMY-R205S-G

Piping "F", "G", "J", "K" size selection rule

(mm [in.])

Total down-stream Indoor capacity	Pipe(Liquid)	Pipe(HP Gas)	Pipe(LP Gas)
P72 or less	$\phi 9.52$ [3/8"]	$\phi 15.88$ [5/8"]	$\phi 19.05$ [3/4"]
P73 to P108	$\phi 9.52$ [3/8"]	$\phi 19.05$ [3/4"]	$\phi 22.20$ [7/8"]
P109 to P126	$\phi 12.70$ [1/2"]	$\phi 19.05$ [3/4"]	$\phi 28.58$ [1-1/8"]
P127 to P144	$\phi 12.70$ [1/2"]	$\phi 22.20$ [7/8"]	$\phi 28.58$ [1-1/8"]
P145 to P216	$\phi 15.88$ [5/8"]	$\phi 22.20$ [7/8"]	$\phi 28.58$ [1-1/8"]
P217 to P234	$\phi 15.88$ [5/8"]	$\phi 28.58$ [1-1/8"]	$\phi 28.58$ [1-1/8"]
P235 to P288	$\phi 19.05$ [3/4"]	$\phi 28.58$ [1-1/8"]	$\phi 34.93$ [1-3/8"]
P289 or above	$\phi 19.05$ [3/4"]	$\phi 28.58$ [1-1/8"]	$\phi 41.28$ [1-5/8"]

HP: High pressure, LP: Low pressure

PQRY-P-T(S)LMU-A1, Y(S)LMU-A1

12-2-4. Total piping length restrictions (m)

[PQRY-P72, 96, 120TLMU-A1/YLMU-A1]

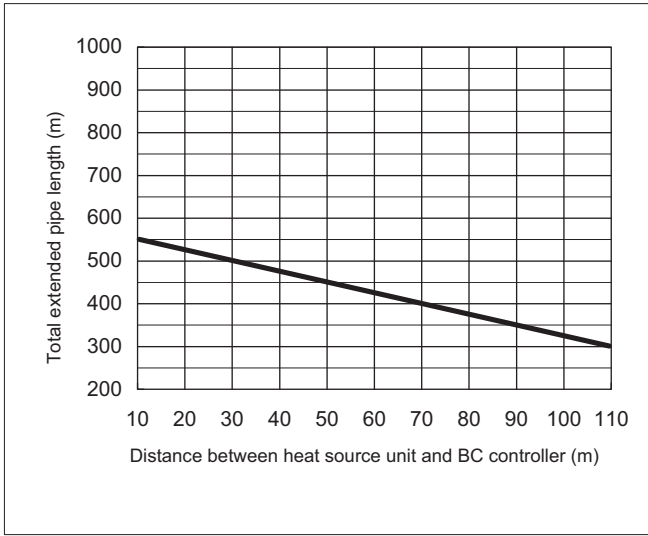

[PQRY-P144, 168, 192, 216, 240TLMU-A1/YLMU-A1]

[PQRY-P144, 168, 192, 216, 240, 288, 312, 336TSLMU-A1/YSLMU-A1]

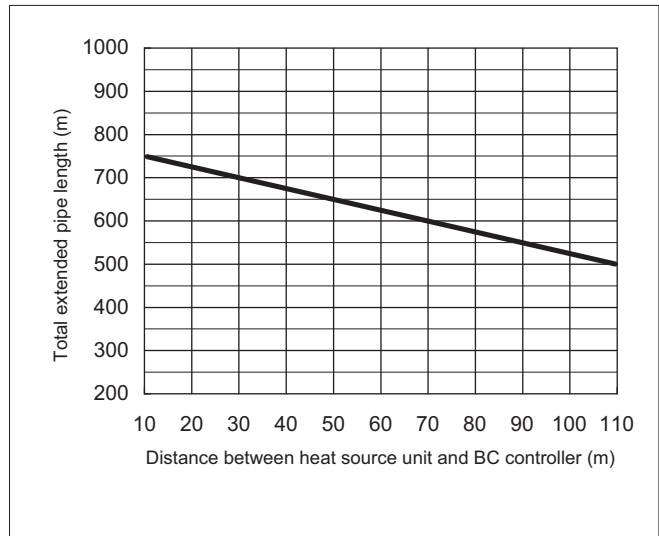

Total piping length restrictions (ft.)

[PQRY-P72, 96, 120TLMU-A1/YLMU-A1]

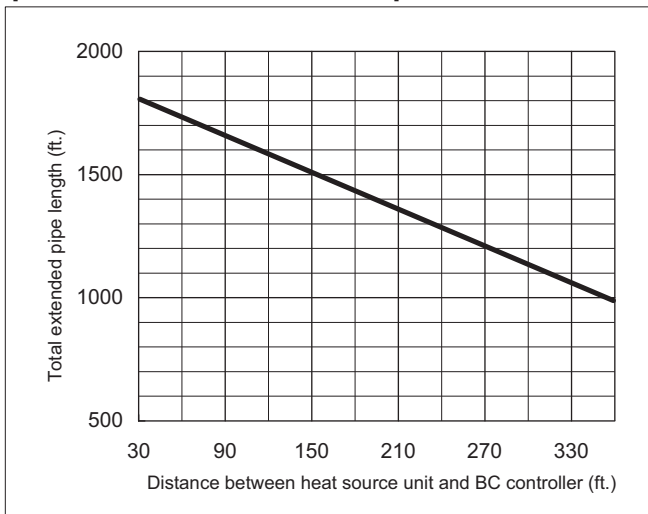

[PQRY-P144, 168, 192, 216, 240TLMU-A1/YLMU-A1]

[PQRY-P144, 168, 192, 216, 240, 288, 312, 336TSLMU-A1/YSLMU-A1]

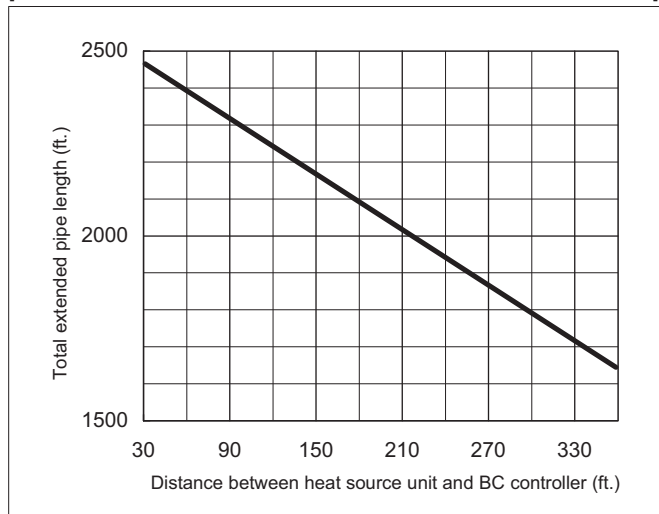

12-3. Refrigerant charging calculation

Sample connection (with 5 BC controllers and 8 indoor units) (PQRV-P288YSLMU-A1)

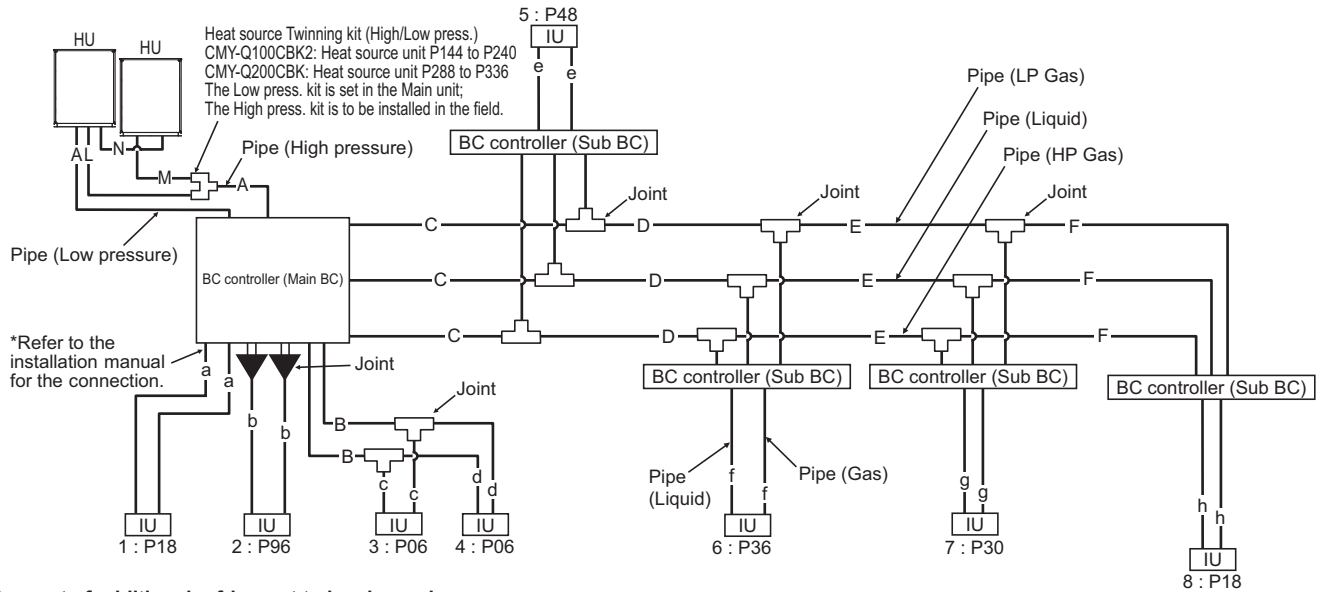

■ Amount of additional refrigerant to be charged

Refrigerant for extended pipes (field piping) is not factory-charged to the outdoor unit. Add an appropriate amount of refrigerant for each pipes on site. Record the size of each high pressure pipe and liquid pipe, and the amount of refrigerant that was charged on the outdoor unit for future reference.

■ Calculating the amount of additional refrigerant to be charged

The amount of refrigerant to be charged is calculated with the size of the on-site-installed high pressure pipes and liquid pipes, and their length.

Calculate the amount of refrigerant to be charged according to the formula below.

Round up the calculation result to the nearest 0.1kg. (i.e., 16.03 kg = 16.1 kg)

<Amount of additional refrigerant to be charged>

■ Calculating the amount of additional refrigerant to be charged

Units "m" and "kg" (In an WR2 system)

<Formula>

- When the piping length from the outdoor unit to the farthest indoor unit is 30.5 m (100 ft) or shorter

Amount of additional charge (kg)	=	High-pressure pipe ø28.58 total length × 0.36 (kg/m)	+	High-pressure pipe ø22.2 total length × 0.23 (kg/m)	+	High-pressure pipe ø19.05 total length × 0.16 (kg/m)	+	High-puressure pipe ø15.88 total length × 0.11(kg/m)		
	+	Liquid pipe ø19.05 total length × 0.29 (kg/m)	+	Liquid pipe ø15.88 total length × 0.2 (kg/m)	+	Liquid pipe ø12.7 total length × 0.12 (kg/m)	+	Liquid pipe ø9.52 total length × 0.06 (kg/m)	+	Liquid pipe ø6.35 total length × 0.024 (kg/m)

Additional charge			
	Heat source unit model	Charged amount	
+	Single	P216	1.0 kg
		P240	1.0 kg

Main or Sub BC controller	Amount (kg/unit)	Total capacity of connected indoor units	Amount (kg) (to be added for indoor unit)	
+	J-type	1.5	27 or below	2.0
	JA-type	3.0	28 to 54	2.5
	KA-type	4.7	55 to 126	3.0
	KB-type	0.4	127 to 144	3.5
			145 to 180	4.5
			181 to 234	5.0
			235 to 273	6.0
			274 to 307	8.0
			308 to 342	9.0
			343 to 411	10.0
		412 to 450	12.0	
		451 or above	14.0	

* High-pressure pipe: Main high-pressure pipe between outdoor unit and BC controller

* Liquid pipe: Liquid pipe between BC controller and indoor unit or between main BC controller and sub BC controller

* When connecting the CMB-P**-NU-G1, CMB-P**-NU-GA1, CMB-P**-NU-HA1, CMB-P**-NU-GB1, or CMB-P**-NU-HB1 to a given system, add the amount of refrigerant as indicated in the table below.

BC controller	Amount (kg/unit)
G1/GA1-type	3.0
HA1-type	5.0
GB1/HB1-type	1.0

• When the piping length from the outdoor unit to the farthest indoor unit is longer than 30.5 m (100 ft)

Amount of additional charge (kg)	=	High-pressure pipe ø28.58 total length × 0.33 (kg/m)	+	High-pressure pipe ø22.2 total length × 0.21 (kg/m)	+	High-pressure pipe ø19.05 total length × 0.14 (kg/m)	+	High-pressure pipe ø15.88 total length × 0.1 (kg/m)	+	Liquid pipe ø19.05 total length × 0.26 (kg/m)	+	Liquid pipe ø15.88 total length × 0.18 (kg/m)	+	Liquid pipe ø12.7 total length × 0.11 (kg/m)	+	Liquid pipe ø9.52 total length × 0.054 (kg/m)	+	Liquid pipe ø6.35 total length × 0.021 (kg/m)
	Additional charge																	

Additional charge		
Heat source unit model	Charged amount	
Single	P216	1.0 kg
	P240	1.0 kg

Main or Sub BC controller	Amount (kg/unit)	Total capacity of connected indoor units	Amount (kg) (to be added for indoor unit)
J-type	1.5	27 or below	2.0
JA-type	3.0	28 to 54	2.5
KA-type	4.7	55 to 126	3.0
KB-type	0.4	127 to 144	3.5
		145 to 180	4.5
		181 to 234	5.0
		235 to 273	6.0
		274 to 307	8.0
		308 to 342	9.0
		343 to 411	10.0
		412 to 450	12.0
		451 or above	14.0

* If the following (1) and (2) are met, add 0.55 kg [20 oz] of refrigerant per indoor unit.

(1) When only PEFY-P18NMAU-E**, PEFY-P24NMAU-E**, or PEFY-P30NMAU-E** are connected

(2) When the total number of connected indoor units is 6 or less

* When connecting PLFY-EP18NEMU**E**, PLFY-EP24NEMU**E**, or PLFY-EP36NEMU**E**, add 0.5 kg [18 oz] of refrigerant per indoor unit.

* High-pressure pipe: Main high-pressure pipe between outdoor unit and BC controller

* Liquid pipe: Liquid pipe between BC controller and indoor unit or between main BC controller and sub BC controller

* When connecting the CMB-P**-NU-G1, CMB-P**-NU-GA1, CMB-P**-NU-HA1, CMB-P**-NU-GB1, or CMB-P**-NU-HB1 to a given system, add the amount of refrigerant as indicated in the table below.

BC controller	Amount (kg/unit)
G1/GA1-type	0
HA1-type	2.0
GB1/HB1-type	1.0

Units "ft" and "oz" (In an WR2 system)

<Formula>

• When the piping length from the outdoor unit to the farthest indoor unit is 30.5 m (100 ft) or shorter

Amount of additional charge (oz)	=	High-pressure pipe ø1-1/8 total length × 3.88 (oz/ft)	+	High-pressure pipe ø7/8 total length × 2.48 (oz/ft)	+	High-pressure pipe ø3/4 total length × 1.73 (oz/ft)	+	High-pressure pipe ø5/8 total length × 1.19 (oz/ft)	+	Liquid pipe ø3/4 total length × 3.13 (oz/ft)	+	Liquid pipe ø5/8 total length × 2.16 (oz/ft)	+	Liquid pipe ø1/2 total length × 1.30 (oz/ft)	+	Liquid pipe ø3/8 total length × 0.65 (oz/ft)	+	Liquid pipe ø1/4 total length × 0.26 (oz/ft)
	Additional charge																	

Additional charge		
Heat source unit model	Charged amount	
Single	P216	36 oz
	P240	36 oz

Main or Sub BC controller	Amount (oz/unit)	Total capacity of connected indoor units	Amount (oz) (to be added for indoor unit)
J-type	53	27 or below	71
JA-type	106	28 to 54	89
KA-type	166	55 to 126	106
KB-type	15	127 to 144	124
		145 to 180	159
		181 to 234	177
		235 to 273	212
		274 to 307	283
		308 to 342	318
		343 to 411	353
		412 to 450	424
		451 or above	494

* High-pressure pipe: Main high-pressure pipe between outdoor unit and BC controller

* Liquid pipe: Liquid pipe between BC controller and indoor unit or between main BC controller and sub BC controller

* When connecting the CMB-P**-NU-G1, CMB-P**-NU-GA1, CMB-P**-NU-HA1, CMB-P**-NU-GB1, or CMB-P**-NU-HB1 to a given system, add the amount of refrigerant as indicated in the table below.

BC controller	Amount (oz/unit)
G1/GA1-type	106
HA1-type	177
GB1/HB1-type	36

• When the piping length from the outdoor unit to the farthest indoor unit is longer than 30.5 m (100 ft)

Amount of additional charge (oz)	=	High-pressure pipe ø1-1/8 total length × 3.55 (oz/ft)	+	High-pressure pipe ø7/8 total length × 2.26 (oz/ft)	+	High-pressure pipe ø3/4 total length × 1.51 (oz/ft)	+	High-pressure pipe ø5/8 total length × 1.08 (oz/ft)							
	+	Liquid pipe ø3/4 total length × 2.81 (oz/ft)	+	Liquid pipe ø5/8 total length × 1.94 (oz/ft)	+	Liquid pipe ø1/2 total length × 1.19 (oz/ft)	+	Liquid pipe ø3/8 total length × 0.59 (oz/ft)	+	Liquid pipe ø1/4 total length × 0.23 (oz/ft)					
Additional charge															
+ Heat source unit model															
Charged amount															
+ Single															
P216 36 oz															
P240 36 oz															
+															
Main or Sub BC controller	Amount (oz/unit)	Total capacity of connected indoor units				Amount (oz) (to be added for indoor unit)									
J-type	53	27 or below				71									
JA-type	106	28 to 54				89									
KA-type	166	55 to 126				106									
KB-type	15	127 to 144				124									
+															
145 to 180											159				
181 to 234											177				
235 to 273											212				
274 to 307											283				
308 to 342											318				
343 to 411											353				
412 to 450											424				
451 or above											494				

* If the following (1) and (2) are met, add 0.55 kg [20 oz] of refrigerant per indoor unit.

(1) When only PEFY-P18NMAU-E**, PEFY-P24NMAU-E**, or PEFY-P30NMAU-E** are connected

(2) When the total number of connected indoor units is 6 or less

* When connecting PLFY-EP18NEMU**-E**, PLFY-EP24NEMU**-E**, or PLFY-EP36NEMU**-E**, add 0.5 kg [18 oz] of refrigerant per indoor unit.

* High-pressure pipe: Main high-pressure pipe between outdoor unit and BC controller

* Liquid pipe: Liquid pipe between BC controller and indoor unit or between main BC controller and sub BC controller

* When connecting the CMB-P**-NU-G1, CMB-P**-NU-GA1, CMB-P**-NU-HA1, CMB-P**-NU-GB1, or CMB-P**-NU-HB1 to a given system, add the amount of refrigerant as indicated in the table below.

BC controller	Amount (oz/unit)
G1/GA1-type	106
HA1-type	177
GB1/HB1-type	36

■ Amount of factory charged refrigerant

Heat source unit Model	Charged amount
P72	5.0 kg
P96	
P120	
P144	
P168	6.0 kg
P192	
P216	11.7 kg
P240	

■ Sample calculation

Units "m" and "kg"

Indoor	1: 18	A: ø28.58	40m	a: ø6.35	10m
	2: 96	B: ø9.52	10m	b: ø9.52	10m
	3: 06	C: ø12.7	20m	c: ø6.35	5m
	4: 06	D: ø9.52	5m	d: ø6.35	5m
	5: 48	E: ø9.52	5m	e: ø9.52	5m
	6: 36	F: ø9.52	5m	f: ø9.52	5m
	7: 30	G: ø19.05	3m	g: ø9.52	5m
	8: 18	H: ø19.05	1m	h: ø6.35	10m

Outdoor P288
Main BC controller CMB-P108NU-JA1
Sub BC controller CMB-P104NU-KB1 × 4

Units "ft" and "oz"

Indoor	1: 18	A: ø1-1/8	131ft	a: ø1/4	32ft
	2: 96	B: ø3/8	32ft	b: ø3/8	32ft
	3: 06	C: ø1/2	65ft	c: ø1/4	16ft
	4: 06	D: ø3/8	16ft	d: ø1/4	16ft
	5: 48	E: ø3/8	16ft	e: ø3/8	16ft
	6: 36	F: ø3/8	16ft	f: ø3/8	16ft
	7: 30	G: ø3/4	9ft	g: ø3/8	16ft
	8: 18	H: ø3/4	3ft	h: ø1/4	32ft

Outdoor P288
Main BC controller CMB-P108NU-JA1
Sub BC controller CMB-P104NU-KB1 × 4

The total length of each liquid line as follows:

ø28.58: A = 40 m
ø19.05: G + H = 4 m
ø12.70: C = 20 m
ø9.52: B + D + E + F + b + e + f + g = 50 m
ø6.35: a + c + d + h = 30 m

<Calculation example>

Additional refrigerant charge
= 40 × 0.33 + 4 × 0.14 + 20 × 0.11 + 50 × 0.054
+ 30 × 0.021 + 3 + 0.4 × 4 + 8
= 31.9 (31.89)kg

The total length of each liquid line as follows:

ø1-1/8: A = 131 ft
ø3/4: G + H = 12 ft
ø1/2: C = 65 ft
ø3/8: B + D + E + F + b + e + f + g = 160 ft
ø1/4: a + c + d + h = 96 ft

<Calculation example>

Additional refrigerant charge
= 131 × 3.54 + 12 × 1.51 + 65 × 1.19 + 160 × 0.59
+ 96 × 0.23 + 106 + 15 × 4 + 283
= 1124.7 (1124.69)oz

■ Limitation of the amount of refrigerant to be charged

The above calculation result of the amount of refrigerant to be charged must become below the value in the table below.
If the amount of refrigerant exceeds the value in the below table, please redesign the system.

Total index of the heat source units		P72 T/YLMU	P96 T/YLMU	P120 T/YLMU	P144 T/YLMU	P168 T/YLMU	P192 T/YLMU	P216 T/YLMU	P240 T/YLMU	P144 T/YSLMU	P168 T/YSLMU
Maximum refrigerant charge	Factory charged	5.0kg	5.0kg	5.0kg	6.0kg	6.0kg	6.0kg	11.7kg	11.7kg	10.0kg	10.0kg
	Charged on site	28.0kg	30.0kg	31.0kg	46.0kg	47.0kg	48.0kg	43.3kg	44.3kg	49.0kg	50.0kg
	Total for system	33.0kg	35.0kg	36.0kg	52.0kg	53.0kg	54.0kg	55.0kg	56.0kg	59.0kg	60.0kg
	Factory charged	11 lbs 1 oz	11 lbs 1 oz	11 lbs 1 oz	13 lbs 4 oz	13 lbs 4 oz	13 lbs 4 oz	25 lbs 13 oz	25 lbs 13 oz	22 lbs 1 oz	22 lbs 1 oz
	Charged on site	61 lbs 12 oz	66 lbs 3 oz	68 lbs 6 oz	101 lbs 7 oz	103 lbs 10 oz	105 lbs 14 oz	95 lbs 8 oz	97 lbs 11 oz	108 lbs 1 oz	110 lbs 4 oz
	Total for system	72 lbs 13 oz	77 lbs 3 oz	79 lbs 6 oz	114 lbs 11 oz	116 lbs 14 oz	119 lbs 1 oz	121 lbs 5 oz	123 lbs 8 oz	130 lbs 2 oz	132 lbs 5 oz

Total index of the heat source units		P192 T/YSLMU	P216 T/YSLMU	P240 T/YSLMU	P288 T/YSLMU	P312 T/YSLMU	P336 T/YSLMU
Maximum refrigerant charge	Factory charged	10.0kg	10.0kg	10.0kg	12.0kg	12.0kg	12.0kg
	Charged on site	51.0kg	52.0kg	54.0kg	70.0kg	70.0kg	73.0kg
	Total for system	61.0kg	62.0kg	64.0kg	82.0kg	82.0kg	85.0kg
	Factory charged	22 lbs 1 oz	22 lbs 1 oz	22 lbs 1 oz	26 lbs 8 oz	26 lbs 8 oz	26 lbs 8 oz
	Charged on site	112 lbs 7 oz	114 lbs 11 oz	119 lbs 1 oz	154 lbs 6 oz	154 lbs 6 oz	160 lbs 15 oz
	Total for system	134 lbs 8 oz	136 lbs 11 oz	141 lbs 2 oz	180 lbs 13 oz	180 lbs 13 oz	187 lbs 7 oz

PQRV-P-T(S)LMU-A1, Y(S)LMU-A1

12-4. Compatibility

Outdoor/Heat source unit	BC controller	Compatibility
PQRY-P-T/Y(S)LMU S/W Ver.6.42 or later	J1 type	Compatible
PQRY-P-T/Y(S)LMU	G1 type	Compatible
PQRY-P-T/Y(S)LMU	G type	Compatible

Outdoor/Heat source unit	BC controller			Compatibility
	Main	Sub		
PQRY-P-T/Y(S)LMU S/W Ver. 6.42 or later	JA1/KA1 type	GB1/HB1 type	GB1/HB1 type	Compatible
	JA1/KA1 type	KB1 type	GB1/HB1 type	Not compatible
	JA1/KA1 type	GB1/HB1 type	GB/HB type	Compatible
	JA1/KA1 type	GB/HB type	GB/HB type	Compatible
	JA1/KA1 type	KB1 type	GB/HB type	Not compatible
	JA1/KA1 type	GB1/HB1 type	-	Compatible
	JA1/KA1 type	GB/HB type	-	Compatible
	GA1/HA1 type	KB1 type	KB1 type	Compatible
	GA1/HA1 type	KB1 type	GB1/HB1 type	Not compatible
	GA1/HA1 type	KB1 type	GB/HB type	Not compatible
	GA1/HA1 type	KB1 type	-	Compatible
	GA/HA type	KB1 type	KB1 type	Compatible
	GA/HA type	KB1 type	GB1/HB1 type	Not compatible
	GA/HA type	KB1 type	GB/HB type	Not compatible
GA/HA type	KB1 type	-	Compatible	

Outdoor/Heat source unit	BC controller		Compatibility
	Main	Sub	
PQRY-P-T/Y(S)LMU S/W Ver. 6.42 or later	JA1/KA1 type	KB1 type	Compatible(*)

*Up to 11 Sub BC controllers can be connected (KB1 type only).

GA(1)/HA(1)/GB(1)/HB(1) type and JA1/KA1/KB1 type can be mixed.

The only combination that is not available is mix of GB(1)/HB(1) type and KB1 type.

When mixing GA(1)/HA(1)/GB(1)/HB(1) type and JA1/KA1/KB1 type, specifications and restrictions are according to GA(1)/HA(1)/GB(1)/HB(1) type. (piping length, connectable number of Sub BC)

PQRY-P-T(S)LMU-A1, Y(S)LMU-A1

13-1. General requirements for installation

1. If possible, locate the unit to reduce the direct thermal radiation to the unit.
2. Consider the amount of noise the unit produces when choosing an installation location.
Valves and refrigerant flow on the outdoor/heat source unit may generate noise.
3. Avoid sites that may encounter strong winds.
4. Ensure the installation site can bear the weight of the unit.
5. Condensation should be moved away from the unit, particularly in heating mode.
6. Provide enough space for installation and service as shown in section 13-2. Spacing.
7. Avoid sites where acidic solutions or chemical sprays (such as sulfur sprays) are used frequently.
8. The unit should be provided from combustible gas, oil, steam, chemical gas like acidic solution, sulfur gas and so on.

13-2. Spacing

In case of single installation, 600mm or more of back space as front space makes easier access when servicing the unit from rear side.

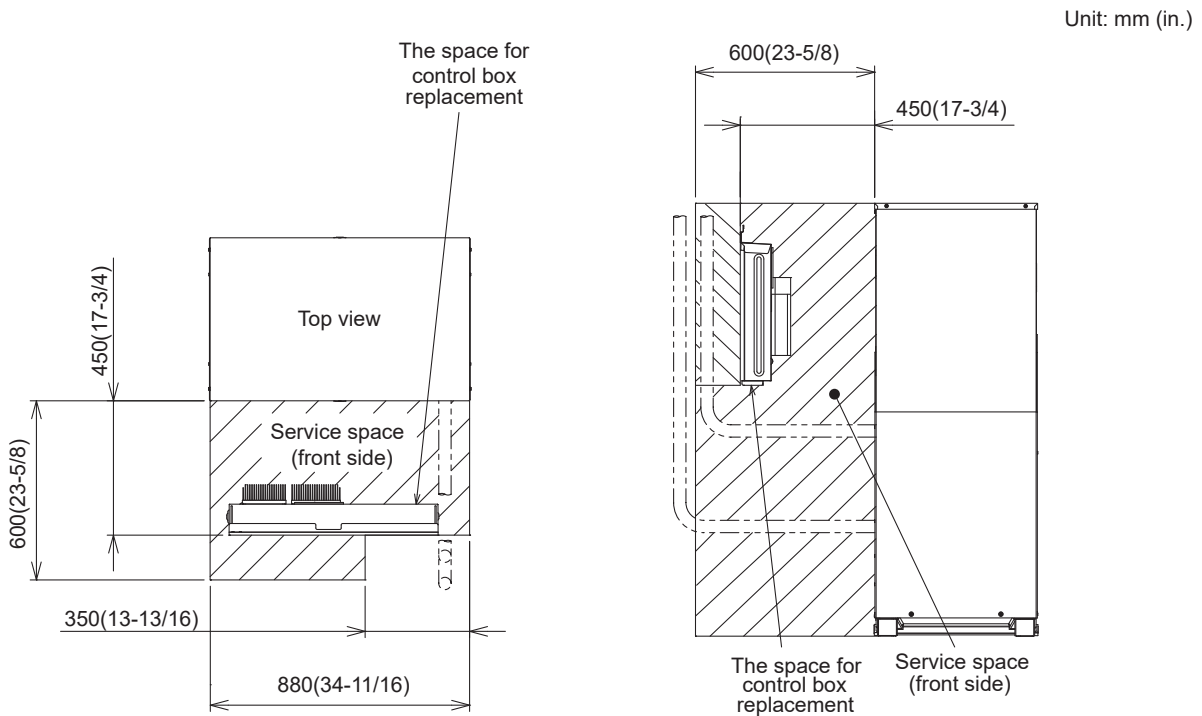

13-3. Piping direction

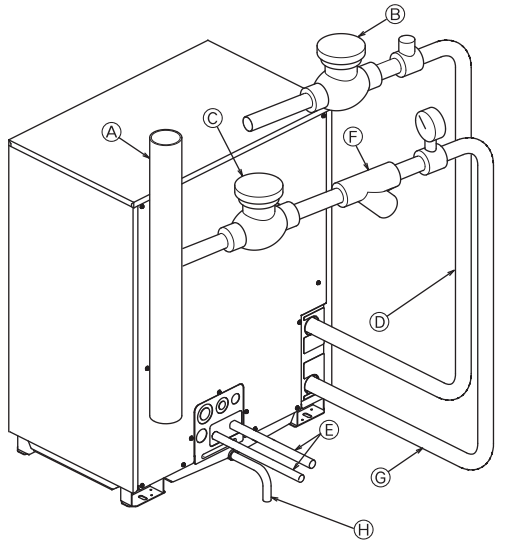

- (A) Main circulating water pipe
- (B) Shutoff valve
- (C) Shutoff valve
- (D) Water outlet (upper)
- (E) Refrigerant pipes
- (F) Y-type strainer
- (G) Water inlet (lower)
- (H) Drain pipe

1. Insulation installation

With City Multi WY/ WR2 Series piping, as long as the temperature range of the inlet water is kept to average temperatures year-round (30°C[86°F] in the summer, 20°C[68°F] in the winter), there is no need to insulate or otherwise protect indoor piping from exposure. You should use insulation in the following situations:

- Any heat source piping.
- Indoor piping in cold-weather regions where frozen pipes are a problem.
- When air coming from the outside causes condensation to form on piping.
- Any drainage piping.

2. Water processing and water quality control

To preserve water quality, use the closed type of cooling tower for WY/ WR2. When the circulating water quality is poor, the water heat exchanger can develop scales, leading to a reduction in heat-exchange power and possible corrosion of the heat exchanger. Please pay careful attention to water processing and water quality control when installing the water circulation system.

- Removal of foreign objects or impurities within the pipes. During installation, be careful that foreign objects, such as welding fragments, sealant particles, or rust, do not enter the pipes.
- Water Quality Processing
 - ① Depending on the quality of the cold-temperature water used in the air conditioner, the copper piping of the heat exchanger may become corroded. We recommend regular water quality processing. Cold water circulation systems using open heat storage tanks are particularly prone to corrosion. When using an open-type heat storage tank, install a water-to-water heat exchanger, and use a closed-loop circuit on the air conditioner side. If a water supply tank is installed, keep contact with air to a minimum, and keep the level of dissolved oxygen in the water no higher than 1mg/ℓ.
 - ② Water quality standard

Items	Lower mid-range temperature water system		Tendency	
	Recirculating water [20<T<60°C] [68<T<140°F]	Make-up water	Corrosive	Scale-forming
pH (25°C)[77°F]	7.0 ~ 8.0	7.0 ~ 8.0	○	○
Electric conductivity (mS/m) (25°C)[77°F]	30 or less	30 or less	○	○
(μS/cm) (25°C)[77°F]	[300 or less]	[300 or less]		
Chloride ion (mg Cl/ℓ)	50 or less	50 or less	○	
Sulfate ion (mg SO ₄ ²⁻ /ℓ)	50 or less	50 or less	○	
Acid consumption (pH4.8) (mg CaCO ₃ /ℓ)	50 or less	50 or less		○
Total hardness (mg CaCO ₃ /ℓ)	70 or less	70 or less		○
Calcium hardness (mg CaCO ₃ /ℓ)	50 or less	50 or less		○
Ionic silica (mg SiO ₂ /ℓ)	30 or less	30 or less		○
Iron (mg Fe/ℓ)	1.0 or less	0.3 or less	○	○
Copper (mg Cu/ℓ)	1.0 or less	0.1 or less	○	
Sulfide ion (mg S ²⁻ /ℓ)	not to be detected	not to be detected	○	
Ammonium ion (mg NH ₄ ⁺ /ℓ)	0.3 or less	0.1 or less	○	
Residual chlorine (mg Cl/ℓ)	0.25 or less	0.3 or less	○	
Free carbon dioxide (mg CO ₂ /ℓ)	0.4 or less	4.0 or less	○	
Ryzner stability index	-	-	○	○

Reference : Guideline of Water Quality for Refrigeration and Air Conditioning Equipment. (JRA GL02E-1994)

- ③ Please consult with a water quality control specialist about water quality control methods and water quality calculations before using anti-corrosive solutions for water quality management.
- ④ When replacing a previously installed air conditioning device (even when only the heat exchanger is being replaced), first conduct a water quality analysis and check for possible corrosion. Corrosion can occur in cold-water systems even if there has been no prior signs of corrosion. If the water quality level has dropped, please adjust water quality sufficiently before replacing the unit.

PQRY-P-T(S)LMU-A1, Y(S)LMU-A1

Installation information

1. Installation information	2
1-1. General precautions	2
1-2. Precautions for Indoor unit and BC controller	4
1-3. Precautions for outdoor unit/heat source unit	5
1-4. Precautions for control-related items	6

* Refer to the enclosed Installation Manual for details on installation. Arrange to have an expert install the system correctly.

1-1. General precautions

1-1-1. Usage

- ♦The air-conditioning system described in this DATA BOOK is designed for human comfort.
- ♦This product is not designed to assist in the preservation of food, provide conditions to maintain plants or animals, or stabilize environments for the preservation of precision equipment or art objects. To prevent loss of quality, do not use the product for purposes other than those it is designed for.
- ♦To reduce the risk of water leakage and electric shock, do not use the product for air-conditioning vehicles or vessels.

1-1-2. Installation environment

- ♦Do not install any unit other than the dedicated unit in an area where the voltage changes significantly, large amounts of mineral oil (e.g., cutting oil) are present, cooking oil may splash, or a large quantity of steam can be generated, such as a kitchen.
- ♦Do not install the unit in acidic or alkaline environments.
- ♦Installation should not be performed in locations exposed to chlorine or other corrosive gases. Avoid installation near sewers.
- ♦To reduce the risk of fire, do not install the unit in an area where flammable gas may leak or flammable material is present.
- ♦This air-conditioning unit has a built-in microcomputer. The effects of noise should be taken into consideration when deciding on the installation position. It is recommended that the air-conditioning unit be installed in a position away from antennas or electronic devices.
- ♦Install the unit on a solid foundation in accordance with local safety measures against typhoons, wind gusts, and earthquakes to prevent the unit from being damaged, toppling over, or falling.

1-1-3. Backup system

- ♦In regions in which the malfunctioning of the air conditioner may have a critical effect, it is recommended to have two or more systems made up of single outdoor/heat source units and multiple indoor units.

1-1-4. Unit characteristics

- ♦The heat pump efficiency of the outdoor unit depends on the outdoor temperature. In heating mode, performance drops as the outside air temperature drops. In cold climates, performance can be poor. Warm air will continue to be trapped near the ceiling and the floor level will remain cold. In such cases, heat pumps require a supplemental heating system or air circulator. Before purchasing, consult your local distributor for assistance in selecting the unit and system.
- ♦When the outdoor temperature is low and the humidity is high, the heat exchanger on the outdoor/heat source unit side tends to collect frost, which reduces its heating performance. The Auto-defrost function will be activated in order to remove the frost, and the heating mode will temporarily stop for 3-10 minutes. Heating mode will automatically resume upon completion of the defrost process.
- ♦An air conditioner with a heat pump requires time to warm up the whole room after the heating operation begins, because the system circulates warm air in order to warm up the whole room.
- ♦Sound levels were obtained in an anechoic room. Sound levels during actual operation are usually higher than the simulated values due to ambient noise and echoes. Refer to the section on "SOUND LEVELS" in the DATA BOOK for the measurement location.
- ♦Depending on the operating conditions, the unit generates noise caused by valve actuation, refrigerant flow, and pressure changes even when operating normally. Try to avoid positioning the air conditioner in locations where quietness is required. With regard to the BC/HBC controller, it is recommended that the unit be installed in areas such as corridor ceilings, restrooms and plant rooms.
- ♦The total capacity of the connected indoor units can be greater than the capacity of the outdoor/heat source unit. However, when the connected indoor units operate simultaneously, each unit's capacity may become smaller than the rated capacity.
- ♦When the unit is started up for the first time within 12 hours after the power comes on, i.e. after a power failure, it performs initial startup operation (capacity control operation) to prevent damage to the compressor. The initial startup operation requires a maximum of 90 minutes to complete, depending on the operating load.

1-1-5. Related equipment

- ♦Use an earth leakage breaker (ELB) with medium sensitivity, and an activation speed of 0.1 second or less.
- ♦Consult your local distributor or a qualified technician when installing an earth leakage breaker.
- ♦If the unit is an inverter type, select an earth leakage breaker able to respond to high harmonic waves and surges.
- ♦Leakage current is generated not only through the air-conditioning unit but also through the power wires. The leakage current of the main power supply is therefore greater than the total leakage current of each unit. Take the capacity of the earth leakage breaker or leakage alarm into consideration when installing one at the main power supply. To measure the leakage current simply on site, use a measurement tool equipped with a filter, and clamp all the four power wires together. The leakage current measured on the ground wire may not be accurate because the leakage current from other systems may be included in the measurement value.
- ♦Do not install a phase-advancing capacitor on a unit connected to the same power system as an inverter-type unit and its related equipment.
- ♦If a large current flows due to the malfunctioning of the product or faulty wiring, both the earth leakage breaker on the product side and the upstream overcurrent breaker may trip almost at the same time. Separate the power system or coordinate all the breakers depending on the system's priority level.

1-1-6. Unit installation

- ♦Your local distributor or a qualified technician must read the Installation Manual that is provided with each unit carefully before performing installation work.
- ♦Consult your local distributor or a qualified technician when installing the unit. Improper installation by an unqualified person may result in water leakage, electric shock, or fire.
- ♦Ensure that there is enough space around each unit.

1-1-7. Optional accessories

- ♦Only use accessories recommended by Mitsubishi Electric. Consult your local distributor or a qualified technician when installing them. Improper installation by an unqualified person may result in water leakage, power leakage, system breakdown, or fire.
- ♦Some optional accessories may not be compatible for use with the air-conditioning unit or may not be suitable for the installation conditions. Check the compatibility when considering any accessories.
- ♦Note that some optional accessories may affect the air conditioner's external form, appearance, weight, operating sound, and other characteristics.

1-1-8. Operation/Maintenance

- ♦Read the Instruction Book that is provided with each unit carefully prior to use.
- ♦Maintenance or cleaning of each unit may be risky and require expertise. Read the Instruction Book to ensure safety. Consult your local distributor or a qualified technician when special expertise is required, such as when the indoor unit needs to be cleaned.

1-2. Precautions for Indoor unit and BC controller

1-2-1. Operating environment

- ♦The refrigerant (R410A) used in the air conditioner is non-toxic and nonflammable. However, if the refrigerant leaks, the oxygen level may drop to harmful levels. If the air conditioner is installed in a small room, measures must be taken to prevent the refrigerant concentration from exceeding the safety limit even if the refrigerant leaks.
- ♦If the units operate in cooling mode at a humidity above 80%, condensation may collect and drip from the indoor units.
- ♦Regular checking and cleaning of the drain drainage paths, such as the drain pan or the drain pump, is recommended to prevent clogging. The neglect of a clogged drain pump may trigger the water-leakage protection function which stops operation of the entire system.

1-2-2. Unit characteristics

- ♦The return air temperature display on the remote controller may differ from the displays on the other thermometers.
- ♦The clock on the remote controller may be displayed with a time lag of approximately one minute every month.
- ♦The temperature measured by the built-in temperature sensor on the remote controller may differ from the actual room temperature due to the effect of the wall temperature.
- ♦Use the built-in thermostat on the remote controller or a separately-sold thermostat when indoor units installed on or in the ceiling operate the automatic cooling/heating switchover.
- ♦The room temperature may rise drastically due to Thermo OFF in areas where the air-conditioning load is large, such as computer rooms.
- ♦Be sure to use a regular filter. If an irregular filter is installed, the unit may not operate properly, and operating noise may increase.
- ♦The room temperature may increase above the preset temperature in environments in which the heating or air-conditioning load is small.

1-2-3. Unit installation

- ♦The insulation for the low-pressure pipe between the BC controller and the outdoor/heat source unit must be at least 20 mm (13/16 in.) thick. If the unit is installed on the top floor or in a high-temperature, high-humidity environment, thicker insulation may be necessary.
- ♦Do not have any branching points on the downstream of the refrigerant pipe header.
- ♦When a field-supplied external thermistor is installed or when a device for demand control is used, the unit may stop abnormally or damage may occur to the electromagnetic contactor. Consult your local distributor for details.
- ♦When indoor units employ fresh air intake, install a filter in the duct (locally procured) to remove dust from the air.
- ♦The 4-way Cassette Type units that have an outside air inlet can be connected to the duct, but need a booster fan to be installed at site. Refer to the chapter "Indoor Unit" for the available range for fresh air intake volume.
- ♦Employing fresh air intake for the indoor unit may increase the sound pressure level.
- ♦Do not install the unit above the cooking or food processing area.

1-2-4. Noise level (Sound pressure level)

- ♦The sound pressure level is a value measured in an anechoic room in accordance with the conventional method in JIS standard. The sound pressure level actually measured at the installation site is usually higher than the value indicated in this DATA BOOK due to the influence of ambient noise and echoes.

1-3. Precautions for outdoor unit/heat source unit

1-3-1. Installation environment

- ♦The outdoor unit with the salt-resistant specification is recommended for use in an area in which it will be exposed to salt air.
- ♦Even when the unit with the salt-resistant specification is used, it is not completely protected against corrosion. Be sure to follow the directions or precautions described in the Instruction Book and Installation Manual for installation and maintenance. The salt-resistant specification is referred to in the guidelines published by JRAIA (JRA9002).
- ♦Install the unit in an area where the flow of discharge air is not obstructed. If the flow of discharge air is obstructed, short-cycling of discharge air may occur.
- ♦Provide proper drainage around the base of the units; condensation may collect and drip from outdoor units. Provide water-proofing protection to the floor when installing the unit on the rooftop.
- ♦In regions where snowfall can be expected, install the unit so that the outlet faces away from the direction of the wind, and install a snow guard to protect the unit from snow. Install the unit on a base approximately 50 cm (19-11/16 in.) higher than the expected snowfall. Close the openings for pipes and wiring, because the ingress of water and small animals may cause equipment damage. If a SUS snow guard is used, refer to the Installation Manual that comes with the snow guard and be careful with the installation to avoid the risk of corrosion.
- ♦When the unit is expected to operate continuously for a long period of time at outside air temperatures of below 0°C (32°F), take appropriate measures, such as the use of a unit base heater, to prevent ice forming on the unit base. (Not applicable to the PUMY-Series)
- ♦Install the snow guard so that the outlet/inlet faces away from the direction of the wind.
- ♦When approximately 50 cm (19-11/16 in.) or more of snow accumulates on the snow guard, remove the snow from the guard. Install a roof that is strong enough to withstand loads caused by snow in areas where snow accumulates.
- ♦Provide proper protection around the outdoor units in places such as schools to avoid the risk of injury.
- ♦A cooling tower and heat source water circuit should be a closed circuit so that water is not exposed to the atmosphere. When a tank is installed to ensure that the circuit has enough water, minimize the contact with outside air to ensure that the oxygen dissolved in the water is 1 mg/L or less.
- ♦Install a strainer (50 mesh or more recommended) on the water pipe inlet on the heat source unit.
- ♦Interlock the heat source unit and water circuit pump.
- ♦Note the following to prevent the freezing and bursting of pipes when the heat source unit is installed in an area where the ambient temperature can be 0°C (32°F) or below.
 - ♦Keep the water circulating to prevent it from freezing when the ambient temperature is 0°C (32°F) or below.
 - ♦Before a long period of non-use, be sure to purge the water from the unit.
- ♦The salt-resistant unit is resistant to salt corrosion, but not salt-proof.

Please note the following when installing and maintaining outdoor units in a marine environment.

 1. Install the salt-resistant unit in an area in which it is not directly exposed to sea breezes, and minimize exposure to salt water mist.
 2. Avoid installing a sun shade over the outdoor unit, so that rain will wash away salt deposits off the unit.
 3. Install the unit horizontally to ensure proper water drainage from the base of the unit. Accumulation of water in the base of the outdoor unit will significantly accelerate corrosion.
 4. Periodically wash salt deposits off the unit, especially when the unit is installed in a coastal area.
 5. Repair all noticeable scratches after installation and during maintenance.
 6. Periodically check the unit, and apply an anti-rust agent and replace corroded parts as necessary.

1-3-2. Circulating water

- ♦Regularly check the quality of the water in the heat source unit, following the guidelines published by JRAIA (JRA-GL02-1994).
- ♦A cooling tower and heat source water circuit should be a closed circuit so that water is not exposed to the atmosphere. When a tank is installed to ensure that the circuit has enough water, minimize the contact with outside air to ensure that the oxygen dissolved in the water is 1 mg/L or less.

1-3-3. Unit characteristics

- ♦When the Thermo ON and OFF is frequently repeated on the indoor unit, the operating status of outdoor/heat source units may become unstable.

1-3-4. Related equipment

- ♦Provide grounding in accordance with the local regulations.

1-3-5. Noise level (Sound pressure level)

- ♦The sound pressure level is a value measured in an anechoic room in accordance with the conventional method in JIS standard. The sound pressure level actually measured at the installation site is usually higher than the value indicated in this DATA BOOK due to the influence of ambient noise and echoes. Valve operation noise and refrigerant flow noise may occur from inside the outdoor unit/heat-source unit.

1-4. Precautions for control-related items

1-4-1. Product specification

- ♦To introduce the MELANS system, a consultation with us is required in advance. Especially to introduce the electricity charge-apportioning function or energy save function, further detailed consultation is required. Consult your local distributor for details.
- ♦Billing calculation for AE-200A/AE-50A/EW-50A, or the billing calculation unit is unique and based on our original method. (Backup operation is included.) It is not based on the metering method, and do not use it for official business purposes. It is not the method that the amount of electric power consumption (input) by air conditioner is calculated. Note that the electric power consumption by air conditioner is apportioned by using the ratio corresponding to the operation status (output) for each air conditioner (indoor unit) in this method.
- ♦In the apportioned billing function for AE-200A/AE-50A and EW-50A, separate watt-hour meters should be used for A-control units, K-control units, and CITY MULTI packaged air conditioners. It is recommended that an individual watt-hour meter should be used for large-capacity indoor units (with two or more addresses).
- ♦When using the peak cut function on the AE-200A/AE-50A or EW-50A, note that the control is performed once every minute and it takes time to obtain the effect of the control. Take appropriate measures such as lowering the criterion value. Power consumption may exceed the limits if the AE-200A/AE-50A or EW-50A malfunctions or stops. Provide a back-up remedy as necessary.
- ♦The controllers cannot operate while the indoor unit is OFF. (No error)
Turn ON the power to the indoor unit when operating the controllers.
- ♦When using the interlocked control function on the AE-200A/AE-50A/EW-50A/PAC-YG66DCA or PAC-YG63MCA, do not use the control for fire prevention or security. (This function should never be used in a way that would put people's lives at risk.) Employ any methods or circuits that allow ON/OFF operation using an external switch in case of failure.

1-4-2. Installation environment

- ♦Surge protection may be required for the transmission line in areas where lightning strikes occur frequently.
- ♦The receiver for a wireless remote controller may not work properly due to the effect of general lighting. Leave a space of at least 1 m between the general lighting and the receiver.
- ♦When the auto-elevating panel is used and the system is operated using a wired remote controller, install the wired remote controller in a place where all the air conditioners being controlled (at least the bottom part of them) can be seen from the wired remote controller. If not, the descending panel may cause damage or injury; be sure to use a wireless remote controller designed for use with the elevating panel (sold separately).
- ♦Install the wired remote controller (switch box) in a place where the following conditions are met.
 - ♦Where the installation surface is flat
 - ♦Where the remote controller can detect an accurate room temperature
The temperature sensors that detect the room temperature are installed both in the remote controller and in the indoor unit.
When the room temperature is detected using the sensor in the remote controller, the main remote controller is used to detect the room temperature. In this case, follow the instructions below.
 - ♦ Install the controller in a place where it is not affected by a heat source.
(If the remote controller faces direct sunlight or the direction of the supply air flow, the remote controller cannot detect the accurate room temperature.)
 - ♦ Install the controller in a place where the average room temperature can be detected.
 - ♦ Install the controller in a place where no other wires are present around the temperature sensor.
(If other wires are present, the remote controller cannot detect an accurate room temperature.)
- ♦To prevent unauthorized access, always use a security device such as a VPN router when connecting the AE-200A/AE-50A or EW-50A to the Internet.

CAUTION FOR REFRIGERANT LEAKAGE

1. Caution for refrigerant leakage	Ub-1-2
1-1. Refrigerant property	Ub-1-2
1-2. Confirm the Critical concentration and take countermeasure	Ub-1-2

1. Caution for refrigerant leakage

The installer and/or air conditioning system specialist shall secure safety against refrigerant leakage according to local regulations or standards. The following standard may be applicable if no local regulation or standard is available.

1-1. Refrigerant property

R410A refrigerant is harmless and incombustible. The R410A is heavier than the indoor air in density. Leakage of the refrigerant in a room has possibility to lead to a hypoxia situation. Therefore, the critical concentration specified below shall not be exceeded even if the leakage happens.

• Critical concentration

Critical concentration hereby is the refrigerant concentration in which no human body would be hurt if immediate measures can be taken when refrigerant leakage happens.

Critical concentration of R410A: 0.44kg/m³
(The weight of refrigeration gas per 1 m³ air conditioning space.);

* The Critical concentration is subject to ISO5149, EN378-1.

For the CITY MULTI system, the concentration of refrigerant leaked should not have a chance to exceed the critical concentration in any situation.

1-2. Confirm the Critical concentration and take countermeasure

The maximum refrigerant leakage concentration (Rmax) is defined as the result of the possible maximum refrigerant weight (Wmax) leaked into a room divided by its room capacity (V). It is referable to Fig.1-1. The refrigerant of Outdoor/Heat source unit here includes its original charge and additional charge at the site.

The additional charge is calculated according to the refrigerant charging calculation of each kind of Outdoor/Heat source unit, and shall not be over charged at the site. Procedure 1-2-1~3 tells how to confirm maximum refrigerant leakage concentration (Rmax) and how to take countermeasures against a possible leakage.

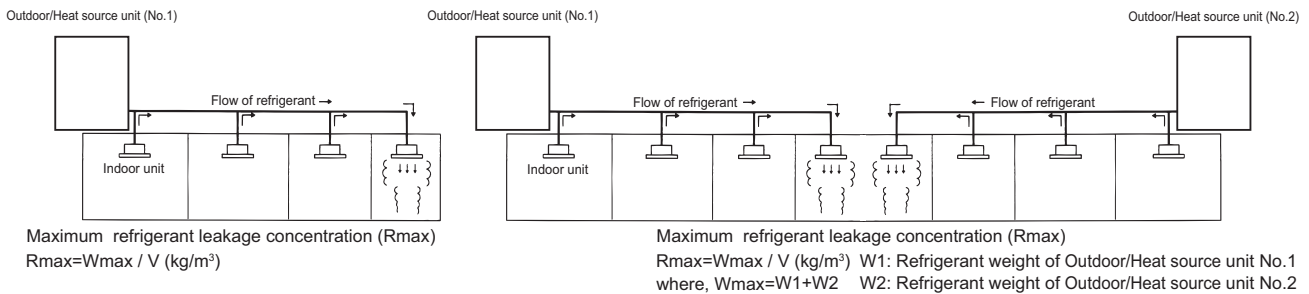

Fig. 1-1 The maximum refrigerant leakage concentration

1-2-1. Find the room capacity (V),

If a room having total opening area more than 0.15% of the floor area at a low position with another room/space, the two rooms/space are considered as one. The total space shall be added up.

1-2-2. Find the possible maximum leakage (Wmax) in the room. If a room has Indoor unit(s) from more than 1 Outdoor/Heat source unit, add up the refrigerant of the Outdoor/Heat source units.

1-2-3. Divide (Wmax) by (V) to get the maximum refrigerant leakage concentration (Rmax).

1-2-4. Find if there is any room in which the maximum refrigerant leakage concentration (Rmax) is over 0.44kg/m³.

If no, then the CITY MULTI is safe against refrigerant leakage.

If yes, following countermeasure is recommended to do at site.

Countermeasure 1: Let-out (making V bigger)

Design an opening of more than 0.15% of the floor area at a low position of the wall to let out the refrigerant whenever leaked. e.g. make the upper and lower seams of door big enough.

Countermeasure 2: Smaller total charge (making Wmax smaller)

e.g. Avoid connecting more than 1 Outdoor/Heat source unit to one room.
 e.g. Using smaller model size but more Outdoor/Heat source units.
 e.g. Shorten the refrigerant piping as much as possible.

Countermeasure 3: Fresh air in from the ceiling (Ventilation)

As the density of the refrigerant is bigger than that of the air. Fresh air supply from the ceiling is better than air exhausting from the ceiling. Fresh air supply solution refers to Fig. 1-2~4.

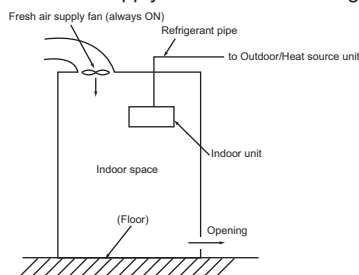

Fig. 1-2. Fresh air supply always ON

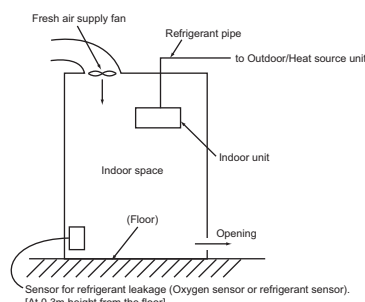

Fig. 1-3. Fresh air supply upon sensor action

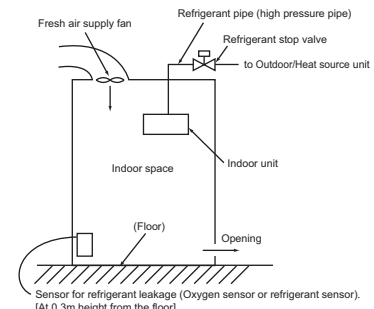

Fig. 1-4. Fresh air supply and refrigerant shut-off upon sensor action

Note 1. Countermeasure 3 should be done in a proper way in which the fresh air supply shall be on whenever the leakage happens.

Note 2. In principle, MITSUBISHI ELECTRIC requires proper piping design, installation and air-tight testing after installation to avoid leakage happening.

In the area should earthquake happen, anti-vibration measures should be fully considered.

The piping should consider the extension due to the temperature variation.

⚠ Warning

- Do not use refrigerant other than the type indicated in the manuals provided with the unit and on the nameplate.
 - Doing so may cause the unit or pipes to burst, or result in explosion or fire during use, repair, or at the time of disposal of the unit.
 - It may also be in violation of applicable laws.
 - MITSUBISHI ELECTRIC CORPORATION cannot be held responsible for malfunctions or accidents resulting from the use of the wrong type of refrigerant.
- Our air conditioning equipment and heat pumps contain a fluorinated greenhouse gas, R410A.

MITSUBISHI ELECTRIC CORPORATION

www.MitsubishiElectric.com