

AIR CONDITIONING SYSTEMS

# CITY MULTI

## DATA BOOK

MODEL

**PUHY-HP72-240T(S)NU-A**

**PUHY-HP72-240Y(S)NU-A**

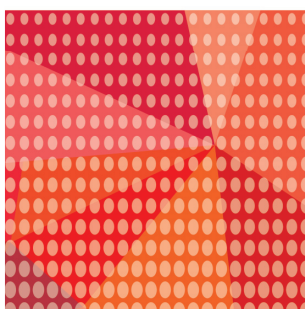

Hyper Heating Inverter Y-Series-208-230V



Type(BTU/h)	72K	96K	120K
Model Name	PUHY-HP72TNU-A	PUHY-HP96TNU-A	PUHY-HP120TNU-A

Hyper Heating Inverter Y-Series-460V



Type(BTU/h)	72K	96K	120K
Model Name	PUHY-HP72YNU-A	PUHY-HP96YNU-A	PUHY-HP120YNU-A

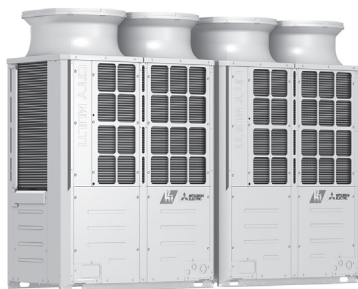

Type(BTU/h)	144K	192K	240K
Model Name	PUHY-HP144TSNU-A	PUHY-HP192TSNU-A	PUHY-HP240TSNU-A

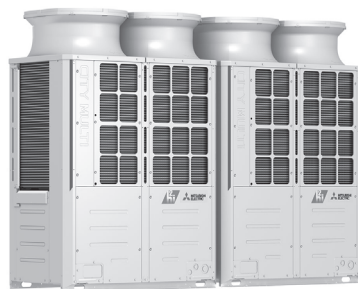

Type(BTU/h)	144K	192K	240K
Model Name	PUHY-HP144YSNU-A	PUHY-HP192YSNU-A	PUHY-HP240YSNU-A

**PUHY-HP-T(S)NU-A, PUHY-HP-Y(S)NU-A**

1. SPECIFICATIONS .....	2
1-1. AHRI 1230-2014 condition.....	2
1-2. AHRI 1230-2021 condition.....	14
2. EXTERNAL DIMENSIONS .....	26
3. CENTER OF GRAVITY .....	32
4. ELECTRICAL WIRING DIAGRAMS .....	33
5. SOUND LEVELS .....	35
5-1. Sound levels in cooling mode .....	35
5-2. Sound levels in heating mode.....	36
6. VIBRATION LEVEL .....	37
7. OPERATION TEMPERATURE RANGE.....	38
8. CAPACITY TABLES .....	39
8-1. Selection of Cooling/Heating Units .....	40
8-2. Correction by temperature .....	50
8-3. Correction by total indoor.....	74
8-4. Correction by refrigerant piping length.....	77
8-5. Correction at frost and defrost .....	79
8-6. Correction at evaporation-temperature (ET) control .....	79
9. OPTIONAL PARTS.....	80
9-1. JOINT .....	80
9-2. HEADER.....	81
9-3. OUTDOOR TWINNING KIT.....	82
9-4. FIN GUARD .....	83
10.ELECTRICAL WORK .....	84
10-1.General cautions .....	84
10-2.Power supply for Outdoor unit.....	85
10-3.Power cable specifications .....	86
10-4.Power supply examples.....	87
11.M-NET CONTROL .....	89
11-1.Transmission cable length limitation.....	89
11-2.Transmission cable specifications.....	90
11-3.System configuration restrictions.....	91
11-4.Address setting.....	95
12.PIPING DESIGN .....	104
12-1.R410A Piping material.....	104
12-2.Piping Design .....	106
12-3.Refrigerant charging calculation .....	109
13.OUTDOOR INSTALLATION .....	112
13-1.General requirements for installation.....	112
13-2.Spacing.....	113
13-3.Piping direction .....	115
13-4.Weather countermeasure .....	120
13-5.Countermeasure to wind .....	120

1-1. AHRI 1230-2014 condition

PUHY-HP-T(S)NU-A, Y(S)NU-A

Outdoor Model			PUHY-HP72TNU-A		
Indoor Model			Non-Ducted		Ducted
Power source			3-phase 3-wire 208-230 V ±10% 60 Hz		
Cooling capacity (Nominal)	*1	BTU/h	72,000		
		kW	21.1		
	(208-230)	Power input	5.39		
		Current input	16.6-15.0		
	(Rated)	BTU/h	69,000		
		kW	20.2		
(208-230)	Power input	4.90	5.07		
	Current input	15.1-13.6	15.6-14.1		
Temp. range of cooling	Indoor	W.B.	59~75°F (15~24°C)		
	Outdoor	D.B.	23~126°F (-5~52°C)		
Heating capacity (Nominal)	*2	BTU/h	80,000		
		kW	23.4		
	(208-230)	Power input	5.33		
		Current input	16.4-14.8		
	(Rated)	BTU/h	76,000		
		kW	22.3		
(208-230)	Power input	4.83	5.04		
	Current input	14.8-13.4	15.5-14.0		
Temp. range of heating	Indoor	D.B.	59~81°F (15~27°C)		
	Outdoor	W.B.	-22~60°F (-30~15.5°C)		
Indoor unit connectable	Total capacity	50~130% of outdoor unit capacity			
	Model/Quantity	P04~P72/1~18			
Sound power level (measured in anechoic room) *3		dB <A>	74.0/76.0		
Refrigerant piping diameter	Liquid pipe	in. (mm)	3/8 (9.52) Brazed		
	Gas pipe	in. (mm)	7/8 (22.2) Brazed		
Minimum Circuit Ampacity		A	55-49		
Maximum Overcurrent Protection		A	90-80		
FAN	Type x Quantity		Propeller fan x 2		
	Airflow rate	cfm	6,700		
		m <sup>3</sup> /min	190		
		L/s	3,170		
	Control, Driving mechanism		Inverter-control, Brushless DC motor		
	Motor output	kW	0.46+0.46		
*4	External static press.		0 in.WG (0 Pa)		
Compressor	Type x Quantity		Inverter scroll hermetic compressor x 1		
	Manufacture		MITSUBISHI ELECTRIC		
	Starting method		Inverter		
	Motor output	kW	3.8 x 1		
	Case heater	kW	-		
	Lubricant		MEL46		
External finish			Pre-coated galvanized steel sheet <MUNSELL 3Y 7.8/1.1 or similar>		
External dimension H x W x D		in.	71-5/8 x 49-1/4 x 29-3/8		
		mm	1,818 x 1,250 x 745		
Protection devices	High pressure protection		High pressure sensor, High pressure switch at 4.15 MPa (601 psi)		
	Inverter circuit (COMP./FAN)		Over-current protection		
	Fan motor		-		
Refrigerant	Type x original charge		R410A x 21 lbs + 10 oz (9.8 kg)		
	Control		LEV and HIC circuit		
Net weight		lbs (kg)	609 (276)		
Heat exchanger			Salt-resistant cross fin & copper tube		
HIC circuit (HIC: Heat Inter-Changer)			Copper pipe, tube-in-tube structure		
Defrosting method			Auto-defrost mode (Reversed refrigerant cycle)		
Drawing	External		KB94C0GM		
	Wiring		KE94G811		
Standard attachment	Document		Installation Manual		
	Accessory		Details refer to External Drw		
Optional parts			joint: CMY-Y102SS/102LS-G2 Header: CMY-Y104/108/1010C-G		
Remarks			Details on foundation work, duct work, insulation work, electrical wiring, power source switch, and other items shall be referred to the Installation Manual.		

Notes:		Unit converter
1.Cooling conditions (Test conditions are based on AHRI 1230) Indoor: 80°F D.B./67°F W.B. (26.7°C D.B./19.4°C W.B.), Outdoor: 95°F D.B. (35°C D.B.)		BTU/h =kW x 3.412
2.Heating conditions (Test conditions are based on AHRI 1230) Indoor: 70°F D.B. (21.1°C D.B.), Outdoor: 47°F D.B./43°F W.B. (8.3°C D.B./6.1°C W.B.)		cfm =m <sup>3</sup> /min x 35.31
3.Cooling mode/Heating mode		lbs =kg/0.4536
4.External static pressure option is available (0.12 in.WG, 0.24 in.WG, 0.32 in.WG/30 Pa, 60 Pa, 80 Pa).		
* Due to continuing improvement, above specifications may be subject to change without notice.		*Above specification data is subject to rounding variation.



# 1. SPECIFICATIONS

Outdoor Model			PUHY-HP96TNU-A		
Indoor Model			Non-Ducted	Ducted	
Power source			3-phase 3-wire 208-230 V ±10% 60 Hz		
Cooling capacity (Nominal)	*1	BTU/h	96,000		
		kW	28.1		
	(208-230)	Power input	kW		6.23
		Current input	A		19.2-17.3
	(Rated)	BTU/h	92,000		
		kW	27.0		
	(208-230)	Power input	kW		5.71
		Current input	A		17.6-15.9
Temp. range of cooling	Indoor	W.B.	59~75°F (15~24°C)		
	Outdoor	D.B.	23~126°F (-5~52°C)		
Heating capacity (Nominal)	*2	BTU/h	108,000		
		kW	31.7		
	(208-230)	Power input	kW		7.33
		Current input	A		22.6-20.4
	(Rated)	BTU/h	103,000		
		kW	30.2		
	(208-230)	Power input	kW		6.65
		Current input	A		20.5-18.5
Temp. range of heating	Indoor	D.B.	59~81°F (15~27°C)		
	Outdoor	W.B.	-22~60°F (-30~15.5°C)		
Indoor unit connectable	Total capacity	50~130% of outdoor unit capacity			
	Model/Quantity	P04-P96/1~24			
Sound power level (measured in anechoic room) *3		dB <A>	76.0/77.5		
Refrigerant piping diameter	Liquid pipe	in. (mm)	3/8 (9.52) Braze (1/2 (12.7) Braze, the farthest pipe length >= 90 m)		
	Gas pipe	in. (mm)	7/8 (22.2) Braze		
Minimum Circuit Ampacity		A	63-57		
Maximum Overcurrent Protection		A	100-90		
FAN	Type x Quantity		Propeller fan x 2		
	Airflow rate	cfm	7,400		
		m <sup>3</sup> /min	210		
		L/s	3,500		
	Control, Driving mechanism		Inverter-control, Brushless DC motor		
	Motor output		kW	0.46+0.46	
*4 External static press.		0 in.WG (0 Pa)			
Compressor	Type x Quantity		Inverter scroll hermetic compressor x 1		
	Manufacture		MITSUBISHI ELECTRIC		
	Starting method		Inverter		
	Motor output	kW	4.5 x 1		
	Case heater	kW	-		
	Lubricant		MEL46		
External finish			Pre-coated galvanized steel sheet <MUNSELL 3Y 7.8/1.1 or similar>		
External dimension H x W x D			in.	71-5/8 x 49-1/4 x 29-3/8	
			mm	1,818 x 1,250 x 745	
Protection devices	High pressure protection		High pressure sensor, High pressure switch at 4.15 MPa (601 psi)		
	Inverter circuit (COMP./FAN)		Over-current protection		
	Fan motor		-		
Refrigerant	Type x original charge		R410A x 23 lbs + 12 oz (10.8 kg)		
	Control		LEV and HIC circuit		
Net weight		lbs (kg)	653 (296)		
Heat exchanger			Salt-resistant cross fin & copper tube		
HIC circuit (HIC: Heat Inter-Changer)			Copper pipe, tube-in-tube structure		
Defrosting method			Auto-defrost mode (Reversed refrigerant cycle)		
Drawing	External		KB94C0GM		
	Wiring		KE94G811		
Standard attachment	Document		Installation Manual		
	Accessory		Details refer to External Drw		
Optional parts			joint: CMY-Y102SS/102LS-G2 Header: CMY-Y104/108/1010C-G		
Remarks			Details on foundation work, duct work, insulation work, electrical wiring, power source switch, and other items shall be referred to the Installation Manual.		

Notes:	Unit converter
1.Cooling conditions (Test conditions are based on AHRI 1230) Indoor: 80°F D.B./67°F W.B. (26.7°C D.B./19.4°C W.B.), Outdoor: 95°F D.B. (35°C D.B.)	BTU/h =kW x 3,412
2.Heating conditions (Test conditions are based on AHRI 1230) Indoor: 70°F D.B. (21.1°C D.B.), Outdoor: 47°F D.B./43°F W.B. (8.3°C D.B./6.1°C W.B.)	cfm =m <sup>3</sup> /min x 35.31
3.Cooling mode/Heating mode	lbs =kg/0.4536
4.External static pressure option is available (0.12 in.WG, 0.24 in.WG, 0.32 in.WG/30 Pa, 60 Pa, 80 Pa).	
* Due to continuing improvement, above specifications may be subject to change without notice.	*Above specification data is subject to rounding variation.

# 1. SPECIFICATIONS

PUHY-HP-T(S)NU-A, Y(S)NU-A

Outdoor Model		PUHY-HP120TNU-A		
Indoor Model		Non-Ducted	Ducted	
Power source		3-phase 3-wire 208-230 V ±10% 60 Hz		
Cooling capacity (Nominal)	*1	BTU/h	120,000	
		kW	35.2	
	(208-230)	Power input	8.53	
		Current input	26.3-23.7	
	(Rated)	BTU/h	114,000	
		kW	33.4	
(208-230)	Power input	7.67	8.11	
	Current input	23.6-21.3	25.0-22.6	
Temp. range of cooling	Indoor	W.B.	59~75°F (15~24°C)	
	Outdoor	D.B.	23~126°F (-5~52°C)	
Heating capacity (Nominal)	*2	BTU/h	135,000	
		kW	39.6	
	(208-230)	Power input	9.63	
		Current input	29.7-26.8	
	(Rated)	BTU/h	129,000	
		kW	37.8	
(208-230)	Power input	8.55	9.28	
	Current input	26.3-23.8	28.6-25.8	
Temp. range of heating	Indoor	D.B.	59~81°F (15~27°C)	
	Outdoor	W.B.	-22~60°F (-30~15.5°C)	
Indoor unit connectable	Total capacity	50~130% of outdoor unit capacity		
	Model/Quantity	P04~P96/1~30		
Sound power level (measured in anechoic room) *3		dB <A>	79.5/80.5	
Refrigerant piping diameter	Liquid pipe	in. (mm)	3/8 (9.52) Braze (1/2 (12.7) Braze, the farthest pipe length >= 40 m)	
	Gas pipe	in. (mm)	1-1/8 (28.58) Braze	
Minimum Circuit Ampacity		A	66-60	
Maximum Overcurrent Protection		A	110-100	
FAN	Type x Quantity		Propeller fan x 2	
	Airflow rate	cfm	7,750	
		m <sup>3</sup> /min	220	
		L/s	3,670	
	Control, Driving mechanism		Inverter-control, Brushless DC motor	
	Motor output	kW	0.46+0.46	
*4 External static press.	0 in.WG (0 Pa)			
Compressor	Type x Quantity		Inverter scroll hermetic compressor x 1	
	Manufacture		MITSUBISHI ELECTRIC	
	Starting method		Inverter	
	Motor output	kW	6.5 x 1	
	Case heater	kW	-	
	Lubricant	MEL46		
External finish		Pre-coated galvanized steel sheet <MUNSELL 3Y 7.8/1.1 or similar>		
External dimension H x W x D		in.	71-5/8 x 49-1/4 x 29-3/8	
		mm	1,818 x 1,250 x 745	
Protection devices	High pressure protection		High pressure sensor, High pressure switch at 4.15 MPa (601 psi)	
	Inverter circuit (COMP./FAN)		Over-current protection	
	Fan motor		-	
Refrigerant	Type x original charge		R410A x 23 lbs + 12 oz (10.8 kg)	
	Control		LEV and HIC circuit	
Net weight	lbs (kg)	655 (297)		
Heat exchanger		Salt-resistant cross fin & copper tube		
HIC circuit (HIC: Heat Inter-Changer)		Copper pipe, tube-in-tube structure		
Defrosting method		Auto-defrost mode (Reversed refrigerant cycle)		
Drawing	External	KB94C0GM		
	Wiring	KE94G811		
Standard attachment	Document	Installation Manual		
	Accessory	Details refer to External Drw		
Optional parts		joint: CMY-Y102SS/102LS-G2, CMY-Y202S-G2 Header: CMY-Y104/108/1010C-G		
Remarks		Details on foundation work, duct work, insulation work, electrical wiring, power source switch, and other items shall be referred to the Installation Manual.		

Notes:	Unit converter
1.Cooling conditions (Test conditions are based on AHRI 1230) Indoor: 80°F D.B./67°F W.B. (26.7°C D.B./19.4°C W.B.), Outdoor: 95°F D.B. (35°C D.B.)	BTU/h =kW x 3.412
2.Heating conditions (Test conditions are based on AHRI 1230) Indoor: 70°F D.B. (21.1°C D.B.), Outdoor: 47°F D.B./43°F W.B. (8.3°C D.B./6.1°C W.B.)	cfm =m <sup>3</sup> /min x 35.31
3.Cooling mode/Heating mode	lbs =kg/0.4536
4.External static pressure option is available (0.12 in.WG, 0.24 in.WG, 0.32 in.WG/30 Pa, 60 Pa, 80 Pa).	
* Due to continuing improvement, above specifications may be subject to change without notice.	*Above specification data is subject to rounding variation.

# 1. SPECIFICATIONS

Outdoor Model		PUHY-HP144TSNU-A		
Indoor Model		Non-Ducted	Ducted	
Power source		3-phase 3-wire 208-230 V ±10% 60 Hz		
Cooling capacity (Nominal)	*1	BTU/h	144,000	
		kW	42.2	
	(208-230)	Power input	12.20	
		Current input	37.6-34.0	
	(Rated)	BTU/h	138,000	
		kW	40.4	
(208-230)	Power input	10.98	11.61	
	Current input	33.8-30.6	35.8-32.3	
Temp. range of cooling	Indoor	W.B.	59~75°F (15~24°C)	
	Outdoor	D.B.	23~126°F (-5~52°C)	
Heating capacity (Nominal)	*2	BTU/h	160,000	
		kW	46.9	
	(208-230)	Power input	11.70	
		Current input	36.0-32.6	
	(Rated)	BTU/h	152,000	
		kW	44.5	
(208-230)	Power input	10.50	11.15	
	Current input	32.3-29.2	34.3-31.0	
Temp. range of heating	Indoor	D.B.	59~81°F (15~27°C)	
	Outdoor	W.B.	-22~60°F (-30~15.5°C)	
Indoor unit connectable	Total capacity	50~130% of outdoor unit capacity		
	Model/Quantity	P04~P96/1~36		
Sound power level (measured in anechoic room) *3		dB <A>	77.5/79.5	
Refrigerant piping diameter	Liquid pipe	1/2 (12.7) Brazed		
	Gas pipe	1-1/8 (28.58) Brazed		

Set Model		PUHY-HP72TNU-A		PUHY-HP72TNU-A		
Model		PUHY-HP72TNU-A		PUHY-HP72TNU-A		
Minimum Circuit Ampacity		A		55-49		
Maximum Overcurrent Protection		A		90-80		
FAN	Type x Quantity		Propeller fan x 2		Propeller fan x 2	
	Airflow rate	cfm	6,700		6,700	
		m <sup>3</sup> /min	190		190	
		L/s	3,170		3,170	
	Control, Driving mechanism		Inverter-control, Brushless DC motor		Inverter-control, Brushless DC motor	
	*4 Motor output		kW		0.46+0.46	
External static press.		0 in.WG (0 Pa)		0 in.WG (0 Pa)		
Compressor	Type x Quantity		Inverter scroll hermetic compressor x 1		Inverter scroll hermetic compressor x 1	
	Manufacture		MITSUBISHI ELECTRIC		MITSUBISHI ELECTRIC	
	Starting method		Inverter		Inverter	
	Motor output		kW		3.8 x 1	
	Case heater		kW		-	
Lubricant		MEL46		MEL46		
External finish		Pre-coated galvanized steel sheet <MUNSELL 3Y 7.8/1.1 or similar>		Pre-coated galvanized steel sheet <MUNSELL 3Y 7.8/1.1 or similar>		
External dimension H x W x D		in.	71-5/8 x 49-1/4 x 29-3/8		71-5/8 x 49-1/4 x 29-3/8	
		mm	1,818 x 1,250 x 745		1,818 x 1,250 x 745	
Protection devices	High pressure protection		High pressure sensor, High pressure switch at 4.15 MPa (601 psi)		High pressure sensor, High pressure switch at 4.15 MPa (601 psi)	
	Inverter circuit (COMP./FAN)		Over-current protection		Over-current protection	
	Fan motor		-		-	
Refrigerant	Type x original charge		R410A x 21 lbs + 10 oz (9.8 kg)		R410A x 21 lbs + 10 oz (9.8 kg)	
	Control		LEV and HIC circuit			
Net weight		lbs (kg)	609 (276)		609 (276)	
Heat exchanger		Salt-resistant cross fin & copper tube		Salt-resistant cross fin & copper tube		
HIC circuit (HIC: Heat Inter-Changer)		Copper pipe, tube-in-tube structure		Copper pipe, tube-in-tube structure		
Pipe between unit and distributor	Liquid pipe	in. (mm)	3/8 (9.52) Brazed		3/8 (9.52) Brazed	
	Gas pipe	in. (mm)	7/8 (22.2) Brazed		7/8 (22.2) Brazed	
Defrosting method		Auto-defrost mode (Reversed refrigerant cycle)				
Drawing	External	KB94C0GN				
	Wiring	KE94G811		KE94G811		
Standard attachment	Document	Installation Manual				
	Accessory	Details refer to External Drw				
Optional parts		Outdoor Twinning kit: CMY-Y100CBK3 joint: CMY-Y102SS/102LS-G2, CMY-Y202S-G2 Header: CMY-Y104/108/1010C-G				
Remarks		Details on foundation work, duct work, insulation work, electrical wiring, power source switch, and other items shall be referred to the Installation Manual.				

Notes:	Unit converter
1.Cooling conditions (Test conditions are based on AHRI 1230) Indoor: 80°F D.B./67°F W.B. (26.7°C D.B./19.4°C W.B.), Outdoor: 95°F D.B. (35°C D.B.)	BTU/h =kW x 3,412
2.Heating conditions (Test conditions are based on AHRI 1230) Indoor: 70°F D.B. (21.1°C D.B.), Outdoor: 47°F D.B./43°F W.B. (8.3°C D.B./6.1°C W.B.)	cfm =m <sup>3</sup> /min x 35.31
3.Cooling mode/Heating mode	lbs =kg/0.4536
4.External static pressure option is available (0.12 in.WG, 0.24 in.WG, 0.32 in.WG/30 Pa, 60 Pa, 80 Pa).	
* Due to continuing improvement, above specifications may be subject to change without notice.	*Above specification data is subject to rounding variation.

# 1. SPECIFICATIONS

Hyper Heating Inverter Y-Series

PUHY-HP-T(S)NU-A, Y(S)NU-A

Outdoor Model			PUHY-HP192TSNU-A		
Indoor Model			Non-Ducted	Ducted	
Power source			3-phase 3-wire 208-230 V ±10% 60 Hz		
Cooling capacity (Nominal)	*1	BTU/h	192,000		
		kW	56.3		
	(208-230)	Power input	13.79		
		Current input	42.5-38.4		
	(Rated)	BTU/h	184,000		
		kW	53.9		
(208-230)	Power input	12.58	12.94		
	Current input	38.7-35.0	39.9-36.0		
Temp. range of cooling	Indoor	W.B.	59~75°F (15~24°C)		
	Outdoor	D.B.	23~126°F (-5~52°C)		
Heating capacity (Nominal)	*2	BTU/h	215,000		
		kW	63.0		
	(208-230)	Power input	15.91		
		Current input	49.0-44.3		
	(Rated)	BTU/h	206,000		
		kW	60.4		
(208-230)	Power input	14.39	15.06		
	Current input	44.3-40.1	46.4-42.0		
Temp. range of heating	Indoor	D.B.	59~81°F (15~27°C)		
	Outdoor	W.B.	-22~60°F (-30~15.5°C)		
Indoor unit connectable	Total capacity	50~130% of outdoor unit capacity			
	Model/Quantity	P04~P96/1~48			
Sound power level (measured in anechoic room) *3		dB <A>	79.5/81.0		
Refrigerant piping diameter	Liquid pipe	in. (mm)	5/8 (15.88) Brazed		
	Gas pipe	in. (mm)	1-1/8 (28.58) Brazed		

Set Model			PUHY-HP96TNU-A		PUHY-HP96TNU-A		
Model			PUHY-HP96TNU-A		PUHY-HP96TNU-A		
Minimum Circuit Ampacity			A		63-57		
Maximum Overcurrent Protection			A		100-90		
FAN	Type x Quantity		Propeller fan x 2		Propeller fan x 2		
	Airflow rate	cfm	7,400		7,400		
		m <sup>3</sup> /min	210		210		
		L/s	3,500		3,500		
	Control, Driving mechanism		Inverter-control, Brushless DC motor		Inverter-control, Brushless DC motor		
	*4	Motor output	kW	0.46+0.46		0.46+0.46	
External static press.		0 in.WG (0 Pa)		0 in.WG (0 Pa)			
Compressor	Type x Quantity		Inverter scroll hermetic compressor x 1		Inverter scroll hermetic compressor x 1		
	Manufacture		MITSUBISHI ELECTRIC		MITSUBISHI ELECTRIC		
	Starting method		Inverter		Inverter		
	Motor output	kW	4.5 x 1		4.5 x 1		
	Case heater	kW	-		-		
	Lubricant		MEL46		MEL46		
External finish			Pre-coated galvanized steel sheet <MUNSELL 3Y 7.8/1.1 or similar>		Pre-coated galvanized steel sheet <MUNSELL 3Y 7.8/1.1 or similar>		
External dimension H x W x D			in.	71-5/8 x 49-1/4 x 29-3/8		71-5/8 x 49-1/4 x 29-3/8	
			mm	1,818 x 1,250 x 745		1,818 x 1,250 x 745	
Protection devices	High pressure protection		High pressure sensor, High pressure switch at 4.15 MPa (601 psi)		High pressure sensor, High pressure switch at 4.15 MPa (601 psi)		
	Inverter circuit (COMP./FAN)		Over-current protection		Over-current protection		
	Fan motor		-		-		
Refrigerant	Type x original charge		R410A x 23 lbs + 12 oz (10.8 kg)		R410A x 23 lbs + 12 oz (10.8 kg)		
	Control		LEV and HIC circuit				
Net weight			lbs (kg)	653 (296)		653 (296)	
Heat exchanger			Salt-resistant cross fin & copper tube		Salt-resistant cross fin & copper tube		
HIC circuit (HIC: Heat Inter-Changer)			Copper pipe, tube-in-tube structure		Copper pipe, tube-in-tube structure		
Pipe between unit and distributor	Liquid pipe	in. (mm)	3/8 (9.52) Brazed		3/8 (9.52) Brazed		
	Gas pipe	in. (mm)	7/8 (22.2) Brazed		7/8 (22.2) Brazed		
Defrosting method			Auto-defrost mode (Reversed refrigerant cycle)				
Drawing	External	KB94C0GN					
	Wiring	KE94G811		KE94G811			
Standard attachment	Document	Installation Manual					
	Accessory	Details refer to External Drw					
Optional parts			Outdoor Twinning kit: CMY-Y100CBK3 joint: CMY-Y102SS/102LS-G2, CMY-Y202S/302S-G2 Header: CMY-Y104/108/1010C-G				
Remarks			Details on foundation work, duct work, insulation work, electrical wiring, power source switch, and other items shall be referred to the Installation Manual.				

Notes:	Unit converter
1. Cooling conditions (Test conditions are based on AHRI 1230) Indoor: 80°F D.B./67°F W.B. (26.7°C D.B./19.4°C W.B.), Outdoor: 95°F D.B. (35°C D.B.)	BTU/h = kW x 3.412
2. Heating conditions (Test conditions are based on AHRI 1230) Indoor: 70°F D.B. (21.1°C D.B.), Outdoor: 47°F D.B./43°F W.B. (8.3°C D.B./6.1°C W.B.)	cfm = m <sup>3</sup> /min x 35.31
3. Cooling mode/Heating mode	lbs = kg/0.4536
4. External static pressure option is available (0.12 in.WG, 0.24 in.WG, 0.32 in.WG/30 Pa, 60 Pa, 80 Pa).	
* Due to continuing improvement, above specifications may be subject to change without notice.	* Above specification data is subject to rounding variation.

# 1. SPECIFICATIONS

Outdoor Model		PUHY-HP240TSNU-A		
Indoor Model		Non-Ducted	Ducted	
Power source		3-phase 3-wire 208-230 V ±10% 60 Hz		
Cooling capacity (Nominal)	*1	BTU/h	240,000	
		kW	70.3	
	(208-230)	Power input	19.37	
		Current input	59.7-54.0	
	(Rated)	BTU/h	228,000	
		kW	66.8	
(208-230)	Power input	17.78	18.08	
	Current input	54.8-49.5	55.7-50.4	
Temp. range of cooling	Indoor	W.B.	59~75°F (15~24°C)	
	Outdoor	D.B.	23~126°F (-5~52°C)	
Heating capacity (Nominal)	*2	BTU/h	270,000	
		kW	79.1	
	(208-230)	Power input	21.38	
		Current input	65.9-59.6	
	(Rated)	BTU/h	258,000	
		kW	75.6	
(208-230)	Power input	19.48	20.10	
	Current input	60.0-54.3	61.9-56.0	
Temp. range of heating	Indoor	D.B.	59~81°F (15~27°C)	
	Outdoor	W.B.	-22~60°F (-30~15.5°C)	
Indoor unit connectable	Total capacity	50~130% of outdoor unit capacity		
	Model/Quantity	P04-P96/2~50		
Sound power level (measured in anechoic room) *3		dB <A>	83.0/84.0	
Refrigerant piping diameter	Liquid pipe	in. (mm)	5/8 (15.88) Brazed	
	Gas pipe	in. (mm)	1-1/8 (28.58) Brazed	

Set Model		PUHY-HP120TNU-A		PUHY-HP120TNU-A		
Model		PUHY-HP120TNU-A		PUHY-HP120TNU-A		
Minimum Circuit Ampacity		A	66-60	66-60		
Maximum Overcurrent Protection		A	110-100	110-100		
FAN	Type x Quantity		Propeller fan x 2		Propeller fan x 2	
	Airflow rate	cfm	7,750	7,750		
		m <sup>3</sup> /min	220	220		
		L/s	3,670	3,670		
	Control, Driving mechanism		Inverter-control, Brushless DC motor		Inverter-control, Brushless DC motor	
	*4	Motor output	kW	0.46+0.46	0.46+0.46	
External static press.		0 in.WG (0 Pa)		0 in.WG (0 Pa)		
Compressor	Type x Quantity		Inverter scroll hermetic compressor x 1		Inverter scroll hermetic compressor x 1	
	Manufacture		MITSUBISHI ELECTRIC		MITSUBISHI ELECTRIC	
	Starting method		Inverter		Inverter	
	Motor output	kW	6.5 x 1	6.5 x 1		
	Case heater	kW	-	-		
Lubricant		MEL46		MEL46		
External finish		Pre-coated galvanized steel sheet <MUNSELL 3Y 7.8/1.1 or similar>		Pre-coated galvanized steel sheet <MUNSELL 3Y 7.8/1.1 or similar>		
External dimension H x W x D		in.	71-5/8 x 49-1/4 x 29-3/8	71-5/8 x 49-1/4 x 29-3/8		
		mm	1,818 x 1,250 x 745	1,818 x 1,250 x 745		
Protection devices	High pressure protection		High pressure sensor, High pressure switch at 4.15 MPa (601 psi)		High pressure sensor, High pressure switch at 4.15 MPa (601 psi)	
	Inverter circuit (COMP./FAN)		Over-current protection		Over-current protection	
	Fan motor		-		-	
Refrigerant	Type x original charge		R410A x 23 lbs + 12 oz (10.8 kg)		R410A x 23 lbs + 12 oz (10.8 kg)	
	Control		LEV and HIC circuit			
Net weight		lbs (kg)	655 (297)	655 (297)		
Heat exchanger		Salt-resistant cross fin & copper tube		Salt-resistant cross fin & copper tube		
HIC circuit (HIC: Heat Inter-Changer)		Copper pipe, tube-in-tube structure		Copper pipe, tube-in-tube structure		
Pipe between unit and distributor	Liquid pipe	in. (mm)	1/2 (12.7) Brazed	1/2 (12.7) Brazed		
	Gas pipe	in. (mm)	1-1/8 (28.58) Brazed	1-1/8 (28.58) Brazed		
Defrosting method		Auto-defrost mode (Reversed refrigerant cycle)				
Drawing	External	KB94C0GN				
	Wiring	KE94G811		KE94G811		
Standard attachment	Document	Installation Manual				
	Accessory	Details refer to External Drw				
Optional parts		Outdoor Twinning kit: CMY-Y100CBK3 joint: CMY-Y102SS/102LS-G2, CMY-Y202S/302S-G2 Header: CMY-Y104/108/1010C-G				
Remarks		Details on foundation work, duct work, insulation work, electrical wiring, power source switch, and other items shall be referred to the Installation Manual.				

Notes:	Unit converter
1.Cooling conditions (Test conditions are based on AHRI 1230) Indoor: 80°F D.B./67°F W.B. (26.7°C D.B./19.4°C W.B.), Outdoor: 95°F D.B. (35°C D.B.)	BTU/h =kW x 3,412
2.Heating conditions (Test conditions are based on AHRI 1230) Indoor: 70°F D.B. (21.1°C D.B.), Outdoor: 47°F D.B./43°F W.B. (8.3°C D.B./6.1°C W.B.)	cfm =m <sup>3</sup> /min x 35.31
3.Cooling mode/Heating mode	lbs =kg/0.4536
4.External static pressure option is available (0.12 in.WG, 0.24 in.WG, 0.32 in.WG/30 Pa, 60 Pa, 80 Pa).	
* Due to continuing improvement, above specifications may be subject to change without notice.	*Above specification data is subject to rounding variation.

# 1. SPECIFICATIONS

Hyper Heating Inverter Y-Series

PUHY-HP-T(S)NU-A, Y(S)NU-A

Outdoor Model		PUHY-HP72YNU-A		
Indoor Model		Non-Ducted	Ducted	
Power source		3-phase 3-wire 460 V ±10% 60 Hz		
Cooling capacity (Nominal)	*1	BTU/h	72,000	
		kW	21.1	
	(460)	Power input	5.39	
		Current input	7.5	
	(Rated)	BTU/h	69,000	
		kW	20.2	
(460)	Power input	4.90	5.07	
	Current input	6.8	7.0	
Temp. range of cooling	Indoor	W.B.	59~75°F (15~24°C)	
	Outdoor	D.B.	23~126°F (-5~52°C)	
Heating capacity (Nominal)	*2	BTU/h	80,000	
		kW	23.4	
	(460)	Power input	5.33	
		Current input	7.4	
	(Rated)	BTU/h	76,000	
		kW	22.3	
(460)	Power input	4.83	5.04	
	Current input	6.7	7.0	
Temp. range of heating	Indoor	D.B.	59~81°F (15~27°C)	
	Outdoor	W.B.	-22~60°F (-30~15.5°C)	
Indoor unit connectable	Total capacity	50~130% of outdoor unit capacity		
	Model/Quantity	P04~P72/1~18		
Sound power level (measured in anechoic room) *3		dB <A>	74.0/76.0	
Refrigerant piping diameter	Liquid pipe	in. (mm)	3/8 (9.52) Brazed	
	Gas pipe	in. (mm)	7/8 (22.2) Brazed	
Minimum Circuit Ampacity		A	25	
Maximum Overcurrent Protection		A	40	
FAN	Type x Quantity		Propeller fan x 2	
	Airflow rate	cfm	6,700	
		m <sup>3</sup> /min	190	
		L/s	3,170	
	Control, Driving mechanism		Inverter-control, Brushless DC motor	
	Motor output	kW	0.46+0.46	
*4 External static press.		0 in.WG (0 Pa)		
Compressor	Type x Quantity		Inverter scroll hermetic compressor x 1	
	Manufacture		MITSUBISHI ELECTRIC	
	Starting method		Inverter	
	Motor output	kW	3.8 x 1	
	Case heater	kW	-	
	Lubricant		MEL46	
External finish		Pre-coated galvanized steel sheet <MUNSELL 3Y 7.8/1.1 or similar>		
External dimension H x W x D		in.	71-5/8 x 49-1/4 x 29-3/8	
		mm	1,818 x 1,250 x 745	
Protection devices	High pressure protection		High pressure sensor, High pressure switch at 4.15 MPa (601 psi)	
	Inverter circuit (COMP./FAN)		Over-current protection	
	Fan motor		-	
Refrigerant	Type x original charge		R410A x 21 lbs + 10 oz (9.8 kg)	
	Control		LEV and HIC circuit	
Net weight	lbs (kg)	644 (292)		
Heat exchanger		Salt-resistant cross fin & copper tube		
HIC circuit (HIC: Heat Inter-Changer)		Copper pipe, tube-in-tube structure		
Defrosting method		Auto-defrost mode (Reversed refrigerant cycle)		
Drawing	External	KB94C0GP		
	Wiring	KE94G817		
Standard attachment	Document	Installation Manual		
	Accessory	Details refer to External Drw		
Optional parts		joint: CMY-Y102SS/102LS-G2 Header: CMY-Y104/108/1010C-G		
Remarks		Details on foundation work, duct work, insulation work, electrical wiring, power source switch, and other items shall be referred to the Installation Manual.		

Notes:	Unit converter
1.Cooling conditions (Test conditions are based on AHRI 1230) Indoor: 80°F D.B./67°F W.B. (26.7°C D.B./19.4°C W.B.), Outdoor: 95°F D.B. (35°C D.B.)	BTU/h =kW x 3.412
2.Heating conditions (Test conditions are based on AHRI 1230) Indoor: 70°F D.B. (21.1°C D.B.), Outdoor: 47°F D.B./43°F W.B. (8.3°C D.B./6.1°C W.B.)	cfm =m <sup>3</sup> /min x 35.31
3.Cooling mode/Heating mode	lbs =kg/0.4536
4.External static pressure option is available (0.12 in.WG, 0.24 in.WG, 0.32 in.WG/30 Pa, 60 Pa, 80 Pa).	
* Due to continuing improvement, above specifications may be subject to change without notice.	*Above specification data is subject to rounding variation.

# 1. SPECIFICATIONS

Outdoor Model			PUHY-HP96YNU-A		
Indoor Model			Non-Ducted	Ducted	
Power source			3-phase 3-wire 460 V ±10% 60 Hz		
Cooling capacity (Nominal)	*1	BTU/h	96,000		
		kW	28.1		
	(460)	Power input	6.23		
		Current input	A		
	(Rated)	BTU/h	92,000		
		kW	27.0		
	(460)	Power input	5.71	5.82	
		Current input	7.9	8.1	
Temp. range of cooling	Indoor	W.B.	59~75°F (15~24°C)		
	Outdoor	D.B.	23~126°F (-5~52°C)		
Heating capacity (Nominal)	*2	BTU/h	108,000		
		kW	31.7		
	(460)	Power input	7.33		
		Current input	A		
	(Rated)	BTU/h	103,000		
		kW	30.2		
	(460)	Power input	6.65	6.92	
		Current input	9.2	9.6	
Temp. range of heating	Indoor	D.B.	59~81°F (15~27°C)		
	Outdoor	W.B.	-22~60°F (-30~15.5°C)		
Indoor unit connectable	Total capacity	50~130% of outdoor unit capacity			
	Model/Quantity	P04-P96/1~24			
Sound power level (measured in anechoic room) *3		dB <A>	76.0/77.5		
Refrigerant piping diameter	Liquid pipe	in. (mm)	3/8 (9.52) Braze (1/2 (12.7) Braze, the farthest pipe length >= 90 m)		
	Gas pipe	in. (mm)	7/8 (22.2) Braze		
Minimum Circuit Ampacity		A	29		
Maximum Overcurrent Protection		A	45		
FAN	Type x Quantity		Propeller fan x 2		
	Airflow rate	cfm	7,400		
		m <sup>3</sup> /min	210		
		L/s	3,500		
	Control, Driving mechanism		Inverter-control, Brushless DC motor		
	Motor output		kW	0.46+0.46	
	*4 External static press.		0 in.WG (0 Pa)		
Compressor	Type x Quantity		Inverter scroll hermetic compressor x 1		
	Manufacture		MITSUBISHI ELECTRIC		
	Starting method		Inverter		
	Motor output	kW	4.5 x 1		
	Case heater	kW	-		
	Lubricant		MEL46		
External finish			Pre-coated galvanized steel sheet <MUNSELL 3Y 7.8/1.1 or similar>		
External dimension H x W x D			in.	71-5/8 x 49-1/4 x 29-3/8	
			mm	1,818 x 1,250 x 745	
Protection devices	High pressure protection		High pressure sensor, High pressure switch at 4.15 MPa (601 psi)		
	Inverter circuit (COMP./FAN)		Over-current protection		
	Fan motor		-		
Refrigerant	Type x original charge		R410A x 23 lbs + 12 oz (10.8 kg)		
	Control		LEV and HIC circuit		
Net weight		lbs (kg)	688 (312)		
Heat exchanger			Salt-resistant cross fin & copper tube		
HIC circuit (HIC: Heat Inter-Changer)			Copper pipe, tube-in-tube structure		
Defrosting method			Auto-defrost mode (Reversed refrigerant cycle)		
Drawing	External		KB94C0GP		
	Wiring		KE94G817		
Standard attachment	Document		Installation Manual		
	Accessory		Details refer to External Drw		
Optional parts			joint: CMY-Y102SS/102LS-G2 Header: CMY-Y104/108/1010C-G		
Remarks			Details on foundation work, duct work, insulation work, electrical wiring, power source switch, and other items shall be referred to the Installation Manual.		

Notes: 1.Cooling conditions (Test conditions are based on AHRI 1230) Indoor: 80°F D.B./67°F W.B. (26.7°C D.B./19.4°C W.B.), Outdoor: 95°F D.B. (35°C D.B.) 2.Heating conditions (Test conditions are based on AHRI 1230) Indoor: 70°F D.B. (21.1°C D.B.), Outdoor: 47°F D.B./43°F W.B. (8.3°C D.B./6.1°C W.B.) 3.Cooling mode/Heating mode 4.External static pressure option is available (0.12 in.WG, 0.24 in.WG, 0.32 in.WG/30 Pa, 60 Pa, 80 Pa).	Unit converter	
	BTU/h	=kW x 3.412
	cfm	=m <sup>3</sup> /min x 35.31
	lbs	=kg/0.4536
	*Above specification data is subject to rounding variation.	
* Due to continuing improvement, above specifications may be subject to change without notice.		

# 1. SPECIFICATIONS

Hyper Heating Inverter Y-Series

PUHY-HP-T(S)NU-A, Y(S)NU-A

Outdoor Model		PUHY-HP120YNU-A		
Indoor Model		Non-Ducted	Ducted	
Power source		3-phase 3-wire 460 V ±10% 60 Hz		
Cooling capacity (Nominal)	*1	BTU/h	120,000	
		kW	35.2	
	(460)	Power input	8.53	
		Current input	11.8	
	(Rated)	BTU/h	114,000	
		kW	33.4	
(460)	Power input	7.67	8.11	
	Current input	10.6	11.3	
Temp. range of cooling	Indoor	W.B.	59~75°F (15~24°C)	
	Outdoor	D.B.	23~126°F (-5~52°C)	
Heating capacity (Nominal)	*2	BTU/h	135,000	
		kW	39.6	
	(460)	Power input	9.63	
		Current input	13.4	
	(Rated)	BTU/h	129,000	
		kW	37.8	
(460)	Power input	8.55	9.28	
(460)	Current input	11.9	12.9	
Temp. range of heating	Indoor	D.B.	59~81°F (15~27°C)	
	Outdoor	W.B.	-22~60°F (-30~15.5°C)	
Indoor unit connectable	Total capacity	50~130% of outdoor unit capacity		
	Model/Quantity	P04~P96/1~30		
Sound power level (measured in anechoic room) *3		dB <A>	79.5/80.5	
Refrigerant piping diameter	Liquid pipe	in. (mm)	3/8 (9.52) Brazed (1/2 (12.7) Brazed, the farthest pipe length >= 40 m)	
	Gas pipe	in. (mm)	1-1/8 (28.58) Brazed	
Minimum Circuit Ampacity		A	35	
Maximum Overcurrent Protection		A	50	
FAN	Type x Quantity	Propeller fan x 2		
	Airflow rate	cfm	7,750	
		m <sup>3</sup> /min	220	
		L/s	3,670	
	Control, Driving mechanism	Inverter-control, Brushless DC motor		
	Motor output	kW	0.46+0.46	
*4 External static press.		0 in.WG (0 Pa)		
Compressor	Type x Quantity	Inverter scroll hermetic compressor x 1		
	Manufacture	MITSUBISHI ELECTRIC		
	Starting method	Inverter		
	Motor output	kW	6.5 x 1	
	Case heater	kW	-	
	Lubricant	MEL46		
External finish		Pre-coated galvanized steel sheet <MUNSELL 3Y 7.8/1.1 or similar>		
External dimension H x W x D	in.	71-5/8 x 49-1/4 x 29-3/8		
	mm	1,818 x 1,250 x 745		
Protection devices	High pressure protection	High pressure sensor, High pressure switch at 4.15 MPa (601 psi)		
	Inverter circuit (COMP./FAN)	Over-current protection		
	Fan motor	-		
Refrigerant	Type x original charge	R410A x 23 lbs + 12 oz (10.8 kg)		
	Control	LEV and HIC circuit		
Net weight	lbs (kg)	691 (313)		
Heat exchanger		Salt-resistant cross fin & copper tube		
HIC circuit (HIC: Heat Inter-Changer)		Copper pipe, tube-in-tube structure		
Defrosting method		Auto-defrost mode (Reversed refrigerant cycle)		
Drawing	External	KB94C0GP		
	Wiring	KE94G817		
Standard attachment	Document	Installation Manual		
	Accessory	Details refer to External Drw		
Optional parts		joint: CMY-Y102SS/102LS-G2, CMY-Y202S-G2 Header: CMY-Y104/108/1010C-G		
Remarks		Details on foundation work, duct work, insulation work, electrical wiring, power source switch, and other items shall be referred to the Installation Manual.		

Notes:	Unit converter
1.Cooling conditions (Test conditions are based on AHRI 1230) Indoor: 80°F D.B./67°F W.B. (26.7°C D.B./19.4°C W.B.), Outdoor: 95°F D.B. (35°C D.B.)	BTU/h =kW x 3.412
2.Heating conditions (Test conditions are based on AHRI 1230) Indoor: 70°F D.B. (21.1°C D.B.), Outdoor: 47°F D.B./43°F W.B. (8.3°C D.B./6.1°C W.B.)	cfm =m <sup>3</sup> /min x 35.31
3.Cooling mode/Heating mode	lbs =kg/0.4536
4.External static pressure option is available (0.12 in.WG, 0.24 in.WG, 0.32 in.WG/30 Pa, 60 Pa, 80 Pa).	
* Due to continuing improvement, above specifications may be subject to change without notice.	*Above specification data is subject to rounding variation.



# 1. SPECIFICATIONS

Outdoor Model		PUHY-HP144YSNU-A	
Indoor Model		Non-Ducted	Ducted
Power source		3-phase 3-wire 460 V ±10% 60 Hz	
Cooling capacity (Nominal)	*1	BTU/h	144,000
		kW	42.2
	(460)	Power input kW	12.20
		Current input A	17.0
	(Rated)	BTU/h	138,000
		kW	40.4
(460)	Power input kW	10.98	11.61
	Current input A	15.3	16.1
	Temp. range of cooling		Indoor W.B. 59~75°F (15~24°C)
	Outdoor D.B. 23~126°F (-5~52°C)		
Heating capacity (Nominal)	*2	BTU/h	160,000
		kW	46.9
	(460)	Power input kW	11.70
		Current input A	16.3
	(Rated)	BTU/h	152,000
		kW	44.5
(460)	Power input kW	10.50	11.15
	Current input A	14.6	15.5
Temp. range of heating		Indoor D.B. 59~81°F (15~27°C)	
Outdoor W.B. -22~60°F (-30~15.5°C)			
Indoor unit connectable		Total capacity 50~130% of outdoor unit capacity	
Model/Quantity		P04-P96/1~36	
Sound power level (measured in anechoic room) *3		dB <A> 77.5/79.5	
Refrigerant piping diameter	Liquid pipe	in. (mm) 1/2 (12.7) Brazed	
	Gas pipe	in. (mm) 1-1/8 (28.58) Brazed	

Set Model			
Model		PUHY-HP72YNU-A	PUHY-HP72YNU-A
Minimum Circuit Ampacity		A 25	25
Maximum Overcurrent Protection		A 40	40
FAN	Type x Quantity		Propeller fan x 2
	Airflow rate	cfm	6,700
		m <sup>3</sup> /min	190
		L/s	3,170
	Control, Driving mechanism		Inverter-control, Brushless DC motor
	*4	Motor output kW	0.46+0.46
External static press.		0 in.WG (0 Pa)	
Compressor	Type x Quantity		Inverter scroll hermetic compressor x 1
	Manufacture		DAIKIN
	Starting method		Inverter
	Motor output kW	3.8 x 1	3.8 x 1
	Case heater kW	-	-
	Lubricant	MEL46	MEL46
External finish		Pre-coated galvanized steel sheet <MUNSELL 3Y 7.8/1.1 or similar>	
External dimension H x W x D		in. 71-5/8 x 49-1/4 x 29-3/8	
		mm 1,818 x 1,250 x 745	
Protection devices	High pressure protection		High pressure sensor, High pressure switch at 4.15 MPa (601 psi)
	Inverter circuit (COMP./FAN)		Over-current protection
	Fan motor		-
Refrigerant	Type x original charge		R410A x 21 lbs + 10 oz (9.8 kg)
	Control		LEV and HIC circuit
Net weight lbs (kg)		644 (292)	
Heat exchanger		Salt-resistant cross fin & copper tube	
HIC circuit (HIC: Heat Inter-Changer)		Copper pipe, tube-in-tube structure	
Pipe between unit and distributor	Liquid pipe	in. (mm) 3/8 (9.52) Brazed	
	Gas pipe	in. (mm) 7/8 (22.2) Brazed	
Defrosting method		Auto-defrost mode (Reversed refrigerant cycle)	
Drawing	External	KB94C0GQ	
	Wiring	KE94G817	KE94G817
Standard attachment	Document	Installation Manual	
	Accessory	Details refer to External Drw	
Optional parts		Outdoor Twinning kit: CMY-Y100CBK3 joint: CMY-Y102SS/102LS-G2, CMY-Y202S-G2 Header: CMY-Y104/108/1010C-G	
Remarks		Details on foundation work, duct work, insulation work, electrical wiring, power source switch, and other items shall be referred to the Installation Manual.	

Notes:	Unit converter
1.Cooling conditions (Test conditions are based on AHRI 1230) Indoor: 80°F D.B./67°F W.B. (26.7°C D.B./19.4°C W.B.), Outdoor: 95°F D.B. (35°C D.B.)	BTU/h =kW x 3,412
2.Heating conditions (Test conditions are based on AHRI 1230) Indoor: 70°F D.B. (21.1°C D.B.), Outdoor: 47°F D.B./43°F W.B. (8.3°C D.B./6.1°C W.B.)	cfm =m <sup>3</sup> /min x 35.31
3.Cooling mode/Heating mode	lbs =kg/0.4536
4.External static pressure option is available (0.12 in.WG, 0.24 in.WG, 0.32 in.WG/30 Pa, 60 Pa, 80 Pa).	
* Due to continuing improvement, above specifications may be subject to change without notice.	*Above specification data is subject to rounding variation.

# 1. SPECIFICATIONS

PUHY-HP-T(S)NU-A, Y(S)NU-A

Outdoor Model			PUHY-HP192YSNU-A		
Indoor Model			Non-Ducted	Ducted	
Power source			3-phase 3-wire 460 V ±10% 60 Hz		
Cooling capacity (Nominal)	*1	BTU/h	192,000		
		kW	56.3		
	(460)	Power input	13.79		
		Current input	19.2		
	(Rated)	BTU/h	184,000		
		kW	53.9		
(460)	Power input	12.58	12.94		
	Current input	17.5	18.0		
	Temp. range of cooling			Indoor: W.B. 59~75°F (15~24°C) Outdoor: D.B. 23~126°F (-5~52°C)	
	Heating capacity (Nominal)			*2	
(Nominal)	*2	BTU/h	215,000		
		kW	63.0		
(460)	Power input	15.91			
	Current input	22.1			
(Rated)	BTU/h	206,000			
	kW	60.4			
(460)	Power input	14.39	15.06		
	Current input	20.0	21.0		
Temp. range of heating			Indoor: D.B. 59~81°F (15~27°C) Outdoor: W.B. -22~60°F (-30~15.5°C)		
Indoor unit connectable			Total capacity: 50~130% of outdoor unit capacity Model/Quantity: P04~P96/1~48		
Sound power level (measured in anechoic room) *3			dB <A> 79.5/81.0		
Refrigerant piping diameter			Liquid pipe: in. (mm) 5/8 (15.88) Brazed Gas pipe: in. (mm) 1-1/8 (28.58) Brazed		

Set Model			PUHY-HP96YNU-A	PUHY-HP96YNU-A
Model			PUHY-HP96YNU-A	PUHY-HP96YNU-A
Minimum Circuit Ampacity			A 29	29
Maximum Overcurrent Protection			A 45	45
FAN	Type x Quantity		Propeller fan x 2	Propeller fan x 2
	Airflow rate	cfm	7,400	7,400
		m <sup>3</sup> /min	210	210
		L/s	3,500	3,500
	Control, Driving mechanism		Inverter-control, Brushless DC motor	Inverter-control, Brushless DC motor
	*4	Motor output	kW 0.46+0.46	0.46+0.46
External static press.		0 in.WG (0 Pa)	0 in.WG (0 Pa)	
Compressor	Type x Quantity		Inverter scroll hermetic compressor x 1	Inverter scroll hermetic compressor x 1
	Manufacture		MITSUBISHI ELECTRIC	MITSUBISHI ELECTRIC
	Starting method		Inverter	Inverter
	Motor output	kW	4.5 x 1	4.5 x 1
	Case heater	kW	-	-
	Lubricant		MEL46	MEL46
External finish			Pre-coated galvanized steel sheet <MUNSELL 3Y 7.8/1.1 or similar>	Pre-coated galvanized steel sheet <MUNSELL 3Y 7.8/1.1 or similar>
External dimension H x W x D			in. 71-5/8 x 49-1/4 x 29-3/8 mm 1,818 x 1,250 x 745	71-5/8 x 49-1/4 x 29-3/8 1,818 x 1,250 x 745
Protection devices	High pressure protection		High pressure sensor, High pressure switch at 4.15 MPa (601 psi)	High pressure sensor, High pressure switch at 4.15 MPa (601 psi)
	Inverter circuit (COMP./FAN)		Over-current protection	Over-current protection
	Fan motor		-	-
Refrigerant	Type x original charge		R410A x 23 lbs + 12 oz (10.8 kg)	R410A x 23 lbs + 12 oz (10.8 kg)
	Control		LEV and HIC circuit	
Net weight			lbs (kg) 688 (312)	688 (312)
Heat exchanger			Salt-resistant cross fin & copper tube	
HIC circuit (HIC: Heat Inter-Changer)			Copper pipe, tube-in-tube structure	
Pipe between unit and distributor	Liquid pipe	in. (mm)	3/8 (9.52) Brazed	3/8 (9.52) Brazed
	Gas pipe	in. (mm)	7/8 (22.2) Brazed	7/8 (22.2) Brazed
Defrosting method			Auto-defrost mode (Reversed refrigerant cycle)	
Drawing	External Wiring		KB94C0GQ	
			KE94G817	KE94G817
Standard attachment	Document		Installation Manual	
	Accessory		Details refer to External Drw	
Optional parts			Outdoor Twinning kit: CMY-Y100CBK3 joint: CMY-Y102SS/102LS-G2, CMY-Y202S/302S-G2 Header: CMY-Y104/108/1010C-G	
Remarks			Details on foundation work, duct work, insulation work, electrical wiring, power source switch, and other items shall be referred to the Installation Manual.	

Notes:	Unit converter
1. Cooling conditions (Test conditions are based on AHRI 1230) Indoor: 80°F D.B./67°F W.B. (26.7°C D.B./19.4°C W.B.), Outdoor: 95°F D.B. (35°C D.B.)	BTU/h = kW x 3.412
2. Heating conditions (Test conditions are based on AHRI 1230) Indoor: 70°F D.B. (21.1°C D.B.), Outdoor: 47°F D.B./43°F W.B. (8.3°C D.B./6.1°C W.B.)	cfm = m <sup>3</sup> /min x 35.31
3. Cooling mode/Heating mode	lbs = kg/0.4536
4. External static pressure option is available (0.12 in.WG, 0.24 in.WG, 0.32 in.WG/30 Pa, 60 Pa, 80 Pa).	
* Due to continuing improvement, above specifications may be subject to change without notice.	* Above specification data is subject to rounding variation.

# 1. SPECIFICATIONS

Outdoor Model		PUHY-HP240YSNU-A	
Indoor Model		Non-Ducted	Ducted
Power source		3-phase 3-wire 460 V ±10% 60 Hz	
Cooling capacity (Nominal)	*1	BTU/h	240,000
		kW	70.3
	(460)	Power input	19.37
		Current input	27.0
	(Rated)	BTU/h	228,000
		kW	66.8
(460)	Power input	17.78	18.08
	Current input	24.7	25.2
	Temp. range of cooling		Indoor W.B. 59~75°F (15~24°C)
	Outdoor D.B. 23~126°F (-5~52°C)		
Heating capacity (Nominal)	*2	BTU/h	270,000
		kW	79.1
	(460)	Power input	21.38
		Current input	29.8
	(Rated)	BTU/h	258,000
		kW	75.6
(460)	Power input	19.48	20.10
	Current input	27.1	28.0
Temp. range of heating		Indoor D.B. 59~81°F (15~27°C)	
Outdoor W.B. -22~60°F (-30~15.5°C)			
Indoor unit connectable		Total capacity 50~130% of outdoor unit capacity	
Model/Quantity		P04~P96/2~50	
Sound power level (measured in anechoic room) *3		dB <A> 83.0/84.0	
Refrigerant piping diameter	Liquid pipe	in. (mm) 5/8 (15.88) Brazed	
	Gas pipe	in. (mm) 1-1/8 (28.58) Brazed	

Set Model		PUHY-HP120YNU-A		PUHY-HP120YNU-A		
Model		PUHY-HP120YNU-A		PUHY-HP120YNU-A		
Minimum Circuit Ampacity		A 35		35		
Maximum Overcurrent Protection		A 50		50		
FAN	Type x Quantity		Propeller fan x 2		Propeller fan x 2	
	Airflow rate	cfm	7,750		7,750	
		m <sup>3</sup> /min	220		220	
		L/s	3,670		3,670	
	Control, Driving mechanism		Inverter-control, Brushless DC motor		Inverter-control, Brushless DC motor	
	*4	Motor output	kW	0.46+0.46		0.46+0.46
External static press.		0 in.WG (0 Pa)		0 in.WG (0 Pa)		
Compressor	Type x Quantity		Inverter scroll hermetic compressor x 1		Inverter scroll hermetic compressor x 1	
	Manufacture		MITSUBISHI ELECTRIC		MITSUBISHI ELECTRIC	
	Starting method		Inverter		Inverter	
	Motor output	kW	6.5 x 1		6.5 x 1	
	Case heater	kW	-		-	
Lubricant		MEL46		MEL46		
External finish		Pre-coated galvanized steel sheet <MUNSELL 3Y 7.8/1.1 or similar>		Pre-coated galvanized steel sheet <MUNSELL 3Y 7.8/1.1 or similar>		
External dimension H x W x D		in.	71-5/8 x 49-1/4 x 29-3/8		71-5/8 x 49-1/4 x 29-3/8	
mm		1,818 x 1,250 x 745		1,818 x 1,250 x 745		
Protection devices	High pressure protection		High pressure sensor, High pressure switch at 4.15 MPa (601 psi)		High pressure sensor, High pressure switch at 4.15 MPa (601 psi)	
	Inverter circuit (COMP./FAN)		Over-current protection		Over-current protection	
	Fan motor		-		-	
Refrigerant	Type x original charge		R410A x 23 lbs + 12 oz (10.8 kg)		R410A x 23 lbs + 12 oz (10.8 kg)	
	Control		LEV and HIC circuit			
Net weight		lbs (kg)	691 (313)		691 (313)	
Heat exchanger		Salt-resistant cross fin & copper tube		Salt-resistant cross fin & copper tube		
HIC circuit (HIC: Heat Inter-Changer)		Copper pipe, tube-in-tube structure		Copper pipe, tube-in-tube structure		
Pipe between unit and distributor	Liquid pipe	in. (mm)	1/2 (12.7) Brazed		1/2 (12.7) Brazed	
	Gas pipe	in. (mm)	1-1/8 (28.58) Brazed		1-1/8 (28.58) Brazed	
Defrosting method		Auto-defrost mode (Reversed refrigerant cycle)				
Drawing	External	KB94C0GQ				
	Wiring	KE94G817		KE94G817		
Standard attachment	Document	Installation Manual				
	Accessory	Details refer to External Drw				
Optional parts		Outdoor Twinning kit: CMY-Y100CBK3 joint: CMY-Y102SS/102LS-G2, CMY-Y202S/302S-G2 Header: CMY-Y104/108/1010C-G				
Remarks		Details on foundation work, duct work, insulation work, electrical wiring, power source switch, and other items shall be referred to the Installation Manual.				

Notes:	Unit converter
1.Cooling conditions (Test conditions are based on AHRI 1230) Indoor: 80°F D.B./67°F W.B. (26.7°C D.B./19.4°C W.B.), Outdoor: 95°F D.B. (35°C D.B.)	BTU/h =kW x 3,412
2.Heating conditions (Test conditions are based on AHRI 1230) Indoor: 70°F D.B. (21.1°C D.B.), Outdoor: 47°F D.B./43°F W.B. (8.3°C D.B./6.1°C W.B.)	cfm =m <sup>3</sup> /min x 35.31
3.Cooling mode/Heating mode	lbs =kg/0.4536
4.External static pressure option is available (0.12 in.WG, 0.24 in.WG, 0.32 in.WG/30 Pa, 60 Pa, 80 Pa).	
* Due to continuing improvement, above specifications may be subject to change without notice.	*Above specification data is subject to rounding variation.

1-2. AHRI 1230-2021 condition

PUHY-HP-T(S)NU-A, Y(S)NU-A

Outdoor Model		PUHY-HP72TNU-A	
Indoor Model		Non-Ducted	Ducted
Power source		3-phase 3-wire 208-230 V ±10% 60 Hz	
Cooling capacity (Nominal)		72,000	
		21.1	
(208-230)	Power input	5.39	
	Current input	16.6-15.0	
(Rated)		69,000	
		20.2	
(208-230)	Power input	5.44	5.59
	Current input	16.7-15.1	17.2-15.5
Temp. range of cooling	Indoor	59~75° F (15~24°C)	
	Outdoor	23~126° F (-5~52°C)	
Heating capacity (Nominal)		80,000	
		23.4	
(208-230)	Power input	5.33	
	Current input	16.4-14.8	
(Rated)		76,000	
		22.3	
(208-230)	Power input	4.83	5.04
	Current input	14.8-13.4	15.5-14.0
Temp. range of heating	Indoor	59~81° F (15~27°C)	
	Outdoor	-22~60° F (-30~15.5°C)	
Indoor unit connectable	Total capacity	50~130% of outdoor unit capacity	
	Model/Quantity	P04~P72 / 1~18	
Sound power level (measured in anechoic room) *3	dB (A)	74.0 / 76.0	
Refrigerant piping diameter	Liquid pipe	3/8 (9.52) Brazed	
	Gas pipe	7/8 (22.2) Brazed	
Minimum Circuit Ampacity	A	55-49	
Maximum Overcurrent Protection	A	90-80	
FAN	Type x Quantity	Propeller fan x 2	
	Airflow rate	cfm	6700 / 6700
		m <sup>3</sup> /min	190 / 190
		L/s	3170 / 3170
	Control, Driving mechanism	Inverter-control , Brushless DC motor	
Motor output	0.46 + 0.46		
*4 External static press.	0 in.WG (0 Pa)		
Compressor	Type x Quantity	Inverter scroll hermetic compressor x 1	
	Starting method	Inverter	
	Motor output	3.8 x 1	
	Case heater	-	
	Lubricant	MEL46	
External finish	Pre-coated galvanized steel sheet <MUNSELL 3Y 7.8/1.1 or similar>		
External dimension H x W x D	in.	71-5/8 x 48-7/8 x 29-3/16	
	mm	1818 x 1240 x 740	
Protection devices	High pressure protection	High pressure sensor , High pressure switch at 4.15 MPa (601 psi)	
	Inverter circuit (COMP./FAN)	Over-heat protection , Over-current protection	
	Compressor	-	
Refrigerant	Type x original charge	R410A x 21 lbs + 9 oz (9.8 kg)	
	Control	LEV and HIC circuit	
Net weight	lbs (kg)	609 (276)	
Heat exchanger	Salt-resistant cross fin & copper tube		
HIC circuit (HIC: Heat Inter-Changer)	Copper pipe , tube-in-tube structure		
Defrosting method	Auto-defrost mode (Reversed refrigerant cycle)		
Drawing	External	KB94C0GM	
	Wiring	KE94G811	
Standard attachment	Document	Installation Manual	
	Accessory	Band	
Optional parts	joint : CMY-Y102SS/102LS-G2 Header : CMY-Y104/108/1010C-G		
Remarks	Details on foundation work, duct work, insulation work, electrical wiring, power source switch, and other items shall be referred to the Installation Manual.		
Notes:	1. Nominal cooling conditions (Test conditions are based on AHRI 1230) Indoor: 80 °FD.B./67 °FW.B. (26.7 °CD.B./19.4 °CW.B.), Outdoor: 95 °FD.B. (35 °CD.B.) 2. Nominal heating conditions (Test conditions are based on AHRI 1230) Indoor: 70 °FD.B. (21.1 °CD.B.), Outdoor: 47 °FD.B./43 °FW.B. (8.3 °CD.B./6.1 °CW.B.) 3. Cooling mode / Heating mode 4. External static pressure option is available (0.12 in.WG, 0.24 in.WG, 0.32 in.WG/30 Pa, 60 Pa, 80 Pa).		Unit converter BTU/h =kW x 3,412 cfm =m <sup>3</sup> /min x 35.31 lbs =kg/0.4536
Due to continuing improvement, above specifications may be subject to change without notice.			*Above specification data is subject to rounding variation.

# 1. SPECIFICATIONS

Outdoor Model		PUHY-HP96TNU-A		
Indoor Model		Non-Ducted	Ducted	
Power source		3-phase 3-wire 208-230 V ±10% 60 Hz		
Cooling capacity (Nominal)	*1	BTU/h	96,000	
		kW	28.1	
	(208-230)	Power input	kW	6.23
		Current input	A	19.2-17.3
	(Rated)		BTU/h	92,000
			kW	27.0
(208-230)	Power input	kW	7.25	
	Current input	A	22.3-20.2	
	Indoor	W.B.	59~75° F (15~24°C)	
	Outdoor	D.B.	23~126° F (-5~52°C)	
Heating capacity (Nominal)	*2	BTU/h	108,000	
		kW	31.7	
	(208-230)	Power input	kW	7.33
		Current input	A	22.6-20.4
	(Rated)		BTU/h	103,000
			kW	30.2
(208-230)	Power input	kW	6.65	
	Current input	A	20.5-18.5	
	Indoor	D.B.	59~81° F (15~27°C)	
	Outdoor	W.B.	-22~60° F (-30~15.5°C)	
Indoor unit connectable		Total capacity 50~130% of outdoor unit capacity Model/Quantity P04~P96 / 1~24		
Sound power level (measured in anechoic room) *3		dB (A) 76.0 / 77.5		
Refrigerant piping diameter	Liquid pipe	3/8 (9.52) Brazed (1/2 (12.7) Brazed, the farthest pipe length ≥90m)		
	Gas pipe	7/8 (22.2) Brazed		
Minimum Circuit Ampacity		A 63-57		
Maximum Overcurrent Protection		A 100-90		
FAN	Type x Quantity		Propeller fan x 2	
	Airflow rate	cfm	7400 / 7400	
		m <sup>3</sup> /min	210 / 210	
	*3		L/s 3500 / 3500	
	Control, Driving mechanism		Inverter-control , Brushless DC motor	
	Motor output	kW	0.46 + 0.46	
*4	External static press.	0 in.WG (0 Pa)		
Compressor	Type x Quantity		Inverter scroll hermetic compressor x 1	
	Starting method		Inverter	
	Motor output	kW	4.5 x 1	
	Case heater	kW	-	
	Lubricant		MEL46	
External finish		Pre-coated galvanized steel sheet <MUNSELL 3Y 7.8/1.1 or similar>		
External dimension H x W x D		in. 71-5/8 x 48-7/8 x 29-3/16 mm 1818 x 1240 x 740		
Protection devices	High pressure protection		High pressure sensor , High pressure switch at 4.15 MPa (601 psi)	
	Inverter circuit (COMP./FAN)		Over-heat protection , Over-current protection	
	Compressor		-	
	Fan motor		-	
Refrigerant	Type x original charge		R410A x 23 lbs + 12 oz (10.8kg)	
	Control		LEV and HIC circuit	
Net weight		lbs (kg) 653 (296)		
Heat exchanger		Salt-resistant cross fin & copper tube		
HIC circuit (HIC: Heat Inter-Changer)		Copper pipe , tube-in-tube structure		
Defrosting method		Auto-defrost mode (Reversed refrigerant cycle)		
Drawing	External		KB94C0GM	
	Wiring		KE94G811	
Standard attachment	Document		Installation Manual	
	Accessory		Band	
Optional parts		joint : CMY-Y102SS/102LS-G2 Header : CMY-Y104/108/1010C-G		
Remarks Details on foundation work, duct work, insulation work, electrical wiring, power source switch, and other items shall be referred to the Installation Manual.				
Notes: 1.Nominal cooling conditions (Test conditions are based on AHRI 1230) Indoor: 80 °FD.B./67 °FW.B. (26.7 °CD.B./19.4 °CW.B.), Outdoor: 95 °FD.B. (35 °CD.B.) 2.Nominal heating conditions (Test conditions are based on AHRI 1230) Indoor: 70 °FD.B. (21.1 °CD.B.), Outdoor: 47 °FD.B./43 °FW.B. (8.3 °CD.B./6.1 °CW.B.) 3.Cooling mode / Heating mode 4.External static pressure option is available (0.12 in.WG, 0.24 in.WG, 0.32 in.WG/30 Pa, 60 Pa, 80 Pa).			Unit converter BTU/h =kW x 3,412 cfm =m <sup>3</sup> /min x 35.31 lbs =kg/0.4536	
Due to continuing improvement, above specifications may be subject to change without notice.			*Above specification data is subject to rounding variation.	

1. SPECIFICATIONS

PUHY-HP-T(S)NU-A, Y(S)NU-A

Outdoor Model		PUHY-HP120TNU-A	
Indoor Model		Non-Ducted	Ducted
Power source		3-phase 3-wire 208-230 V ±10% 60 Hz	
Cooling capacity (Nominal)	*1	BTU/h	120,000
		kW	35.2
(208-230)	Power input	kW	8.53
	Current input	A	26.3-23.7
(Rated)		BTU/h	115,000
		kW	33.7
(208-230)	Power input	kW	10.13
	Current input	A	31.2-28.2
Temp. range of cooling	Indoor	W.B.	59~75 F (15~24°C)
	Outdoor	D.B.	23~126 F (-5~52°C)
Heating capacity (Nominal)	*2	BTU/h	135,000
		kW	39.6
(208-230)	Power input	kW	9.63
	Current input	A	29.7-26.8
(Rated)		BTU/h	129,000
		kW	37.8
(208-230)	Power input	kW	8.55
	Current input	A	26.3-23.8
Temp. range of heating	Indoor	D.B.	59~81 F (15~27°C)
	Outdoor	W.B.	-22~60 F (-30~15.5°C)
Indoor unit connectable		Total capacity 50~130% of outdoor unit capacity Model/Quantity P04~P96 / 1~30	
Sound power level (measured in anechoic room) *3		dB (A) 79.5 / 80.5	
Refrigerant piping diameter	Liquid pipe	in. (mm)	3/8 (9.52) Brazed(1/2(12.7)Brazed, the farthest pipe length ≥40m)
	Gas pipe	in. (mm)	1-1/8 (28.58) Brazed
Minimum Circuit Ampacity		A 66-60	
Maximum Overcurrent Protection		A 110-100	
FAN	Type x Quantity		Propeller fan x 2
	Airflow rate	cfm	7750 / 7750
		m <sup>3</sup> /min	220 / 220
	*3	L/s	3670 / 3670
Control, Driving mechanism		Inverter-control , Brushless DC motor	
Motor output	kW	0.46 + 0.46	
	External static press.	0 in.WG (0 Pa)	
Compressor	Type x Quantity		Inverter scroll hermetic compressor x 1
	Starting method		Inverter
	Motor output	kW	6.5 x 1
	Case heater	kW	-
Lubricant		MEL46	
External finish		Pre-coated galvanized steel sheet <MUNSELL 3Y 7.8/1.1 or similar>	
External dimension H x W x D		in. 71-5/8 x 48-7/8 x 29-3/16 mm 1818 x 1240 x 740	
Protection devices	High pressure protection		High pressure sensor , High pressure switch at 4.15 MPa (601 psi)
	Inverter circuit (COMP./FAN)		Over-heat protection , Over-current protection
	Compressor		-
	Fan motor		-
Refrigerant	Type x original charge		R410A x 23 lbs + 12 oz (10.8kg)
	Control		LEV and HIC circuit
Net weight		lbs (kg) 655 (297)	
Heat exchanger		Salt-resistant cross fin & copper tube	
HIC circuit (HIC: Heat Inter-Changer)		Copper pipe , tube-in-tube structure	
Defrosting method		Auto-defrost mode (Reversed refrigerant cycle)	
Drawing	External		KB94C0GM
	Wiring		KE94G811
Standard attachment	Document		Installation Manual
	Accessory		Band
Optional parts		joint : CMY-Y102SS/102LS-G2, CMY-Y202S-G2 Header : CMY-Y104/108/1010C-G	
Remarks Details on foundation work, duct work, insulation work, electrical wiring, power source switch, and other items shall be referred to the Installation Manual.			
Notes: 1.Nominal cooling conditions (Test conditions are based on AHRI 1230) Indoor: 80 °FD.B./67 °FW.B. (26.7 °CD.B./19.4 °CW.B.), Outdoor: 95 °FD.B. (35 °CD.B.) 2.Nominal heating conditions (Test conditions are based on AHRI 1230) Indoor: 70 °FD.B. (21.1 °CD.B.), Outdoor: 47 °FD.B./43 °FW.B. (8.3 °CD.B./6.1 °CW.B.) 3.Cooling mode / Heating mode 4.External static pressure option is available (0.12 in.WG, 0.24 in.WG, 0.32 in.WG/30 Pa, 60 Pa, 80 Pa).			Unit converter BTU/h =kW x 3.412 cfm =m <sup>3</sup> /min x 35.31 lbs =kg/0.4536
Due to continuing improvement, above specifications may be subject to change without notice.			*Above specification data is subject to rounding variation.



# 1. SPECIFICATIONS

Outdoor Model		PUHY-HP144TSNU-A	
Indoor Model		Non-Ducted	Ducted
Power source		3-phase 3-wire 208-230 V ±10% 60 Hz	
Cooling capacity (Nominal)	*1	BTU/h	144,000
		kW	42.2
(208-230)	Power input	kW	12.20
	Current input	A	37.6-34.0
(Rated)		BTU/h	138,000
		kW	40.4
(208-230)	Power input	kW	11.73
	Current input	A	36.1-32.7
Temp. range of cooling	Indoor	W.B.	59~75° F (15~24°C)
	Outdoor	D.B.	23~126° F (-5~52°C)
Heating capacity (Nominal)	*2	BTU/h	160,000
		kW	46.9
(208-230)	Power input	kW	11.70
	Current input	A	36.0-32.6
(Rated)		BTU/h	152,000
		kW	44.5
(208-230)	Power input	kW	10.50
	Current input	A	32.3-29.2
Temp. range of heating	Indoor	D.B.	59~81° F (15~27°C)
	Outdoor	W.B.	-22~60° F (-30~15.5°C)
Indoor unit connectable	Total capacity	50~130% of outdoor unit capacity	
	Model/Quantity	P04~P96 / 1~36	
Sound power level (measured in anechoic room) *3		dB (A)	77.5 / 79.5
Refrigerant piping diameter	Liquid pipe	in. (mm)	1/2 (12.7) Brazed
	Gas pipe	in. (mm)	1-1/8 (28.58) Brazed

Set Model		PUHY-HP72TNU-A	PUHY-HP72TNU-A
Model		PUHY-HP72TNU-A	PUHY-HP72TNU-A
Minimum Circuit Ampacity		A	55-49
Maximum Overcurrent Protection		A	90-80
FAN	Type x Quantity	Propeller fan x 2	
	Airflow rate	cfm	6700 / 6700
		m <sup>3</sup> /min	190 / 190
	*3	L/s	3170 / 3170
	Control, Driving mechanism	Inverter-control , Brushless DC motor	
*4	Motor output	kW	0.46 + 0.46
	External static press.	0 in.WG (0 Pa)	
Compressor	Type x Quantity	Inverter scroll hermetic compressor x 1	
	Starting method	Inverter	
	Motor output	kW	3.8 x 1
	Case heater	kW	-
	Lubricant	MEL46	
External finish		Pre-coated galvanized steel sheet <MUNSELL 3Y 7.8/1.1 or similar>	
External dimension H x W x D		in.	71-5/8 x 48-7/8 x 29-3/16
		mm	1818 x 1240 x 740
Protection devices	High pressure protection	High pressure sensor , High pressure switch at 4.15 MPa (601 psi)	
	Inverter circuit (COMP./FAN)	Over-heat protection , Over-current protection	
	Compressor	-	
	Fan motor	-	
Refrigerant	Type x original charge	R410A x 21 lbs + 9 oz (9.8 kg)	
	Control	LEV and HIC circuit	
Net weight		lbs (kg)	609 (276)
Heat exchanger		Salt-resistant cross fin & copper tube	
HIC circuit (HIC: Heat Inter-Changer)		Copper pipe , tube-in-tube structure	
Pipe between unit and distributor	Liquid pipe	in. (mm)	3/8 (9.52) Brazed
	Gas pipe	in. (mm)	7/8 (22.2) Brazed
Defrosting method		Auto-defrost mode (Reversed refrigerant cycle)	
Drawing	External	KB94C0GN	
	Wiring	KE94G811	KE94G811
Standard attachment	Document	Installation Manual	
	Accessory	Band	
Optional parts		Outdoor Twinning Kit : CMY-Y100CBK3 joint : CMY-Y102SS/102LS-G2 , CMY-Y202S-G2 Header : CMY-Y104/108/1010C-G	

**Remarks**  
Details on foundation work, duct work, insulation work, electrical wiring, power source switch, and other items shall be referred to the Installation Manual.

- Notes:**
- Nominal cooling conditions (Test conditions are based on AHRI 1230)  
Indoor: 80 °FD.B./67 °FW.B. (26.7 °CD.B./19.4 °CW.B.), Outdoor: 95 °FD.B. (35 °CD.B.)
  - Nominal heating conditions (Test conditions are based on AHRI 1230)  
Indoor: 70 °FD.B. (21.1 °CD.B.), Outdoor: 47 °FD.B./43 °FW.B. (8.3 °CD.B./6.1 °CW.B.)
  - Cooling mode / Heating mode
  - External static pressure option is available (0.12 in.WG, 0.24 in.WG, 0.32 in.WG/30 Pa, 60 Pa, 80 Pa).

Unit converter	
BTU/h	=kW x 3,412
cfm	=m <sup>3</sup> /min x 35.31
lbs	=kg/0.4536

Due to continuing improvement, above specifications may be subject to change without notice.

\*Above specification data is subject to rounding variation.

1. SPECIFICATIONS

PUHY-HP-T(S)NU-A, Y(S)NU-A

Outdoor Model			PUHY-HP192TSNU-A		
Indoor Model			Non-Ducted		Ducted
Power source			3-phase 3-wire 208-230 V ±10% 60 Hz		
Cooling capacity (Nominal)	*1	BTU/h	192,000		
		kW	56.3		
(208-230)	(Rated)	Power input	13.79		
		Current input	42.5-38.4		
(208-230)	(Rated)	BTU/h	184,000		
		kW	53.9		
(208-230)	(Rated)	Power input	15.79		15.27
		Current input	48.6-44.0		47.0-42.5
Temp. range of cooling	Indoor	W.B.	59~75° F (15~24°C)		
	Outdoor	D.B.	23~126° F (-5~52°C)		
Heating capacity (Nominal)	*2	BTU/h	215,000		
		kW	63.0		
(208-230)	(Rated)	Power input	15.91		
		Current input	49.0-44.3		
(208-230)	(Rated)	BTU/h	206,000		
		kW	60.4		
(208-230)	(Rated)	Power input	14.39		14.79
		Current input	44.3-40.1		45.6-41.2
Temp. range of heating	Indoor	D.B.	59~81° F (15~27°C)		
	Outdoor	W.B.	-22~60° F (-30~15.5°C)		
Indoor unit connectable			50~130% of outdoor unit capacity		
Model/Quantity			P04~P96 / 1~48		
Sound power level (measured in anechoic room) *3			dB (A) 79.5 / 81.0		
Refrigerant piping diameter			Liquid pipe in. (mm) 5/8 (15.88) Brazed Gas pipe in. (mm) 1-1/8 (28.58) Brazed		

Set Model			PUHY-HP96TNU-A		PUHY-HP96TNU-A
Model			PUHY-HP96TNU-A		PUHY-HP96TNU-A
Minimum Circuit Ampacity			63-57		63-57
Maximum Overcurrent Protection			100-90		100-90
FAN	Type x Quantity		Propeller fan x 2		Propeller fan x 2
	Airflow rate	cfm	7400 / 7400		7400 / 7400
		m <sup>3</sup> /min	210 / 210		210 / 210
	*3	L/s	3500 / 3500		3500 / 3500
			Control, Driving mechanism		Inverter-control , Brushless DC motor
Compressor	*4		0.46 + 0.46		0.46 + 0.46
	External static press.		0 in.WG (0 Pa)		0 in.WG (0 Pa)
	Type x Quantity		Inverter scroll hermetic compressorx 1		Inverter scroll hermetic compressorx 1
	Starting method		Inverter		Inverter
	Motor output	kW	4.5x 1		4.5x 1
Case heater			-		-
Lubricant			MEL46		MEL46
External finish			Pre-coated galvanized steel sheet <MUNSELL 3Y 7.8/1.1 or similar>		Pre-coated galvanized steel sheet <MUNSELL 3Y 7.8/1.1 or similar>
External dimension H x W x D			in. 71-5/8 x 48-7/8 x 29-3/16		71-5/8 x 48-7/8 x 29-3/16
			mm 1818 x 1240 x 740		1818 x 1240 x 740
Protection devices	High pressure protection		High pressure sensor , High pressure switch at 4.15 MPa (601 psi)		High pressure sensor , High pressure switch at 4.15 MPa (601 psi)
	Inverter circuit (COMP./FAN)		Over-heat protection , Over-current protection		Over-heat protection , Over-current protection
	Compressor		-		-
	Fan motor		-		-
Refrigerant	Type x original charge		R410A x 23 lbs + 12 oz (10.8kg)		R410A x 23 lbs + 12 oz (10.8kg)
	Control		LEV and HIC circuit		
Net weight			lbs (kg) 653 (296)		653 (296)
Heat exchanger			Salt-resistant cross fin & copper tube		Salt-resistant cross fin & copper tube
HIC circuit (HIC: Heat Inter-Changer)			Copper pipe , tube-in-tube structure		Copper pipe , tube-in-tube structure
Pipe between unit and distributor	Liquid pipe	in. (mm)	3/8 (9.52) Brazed		3/8 (9.52) Brazed
	Gas pipe	in. (mm)	7/8 (22.2) Brazed		7/8 (22.2) Brazed
Defrosting method			Auto-defrost mode (Reversed refrigerant cycle)		
Drawing	External		KB94C0GN		
	Wiring		KE94G811		KE94G811
Standard attachment	Document		Installation Manual		
	Accessory		Band		
Optional parts			Outdoor Twinning kit : CMY-Y100CBK3 joint : CMY-Y102SS/102LS-G2 , CMY-Y202S/302S-G2 Header : CMY-Y104/108/1010C-G		

Remarks  
Details on foundation work, duct work, insulation work, electrical wiring, power source switch, and other items shall be referred to the Installation Manual.

- Notes:
- Nominal cooling conditions (Test conditions are based on AHRI 1230)  
Indoor: 80 °FD.B./67 °FW.B. (26.7 °CD.B./19.4 °CW.B.), Outdoor: 95 °FD.B. (35 °CD.B.)
  - Nominal heating conditions (Test conditions are based on AHRI 1230)  
Indoor: 70 °FD.B. (21.1 °CD.B.), Outdoor: 47 °FD.B./43 °FW.B. (8.3 °CD.B./6.1 °CW.B.)
  - Cooling mode / Heating mode
  - External static pressure option is available (0.12 in.WG, 0.24 in.WG, 0.32 in.WG/30 Pa, 60 Pa, 80 Pa).

Unit converter	
BTU/h	=kW x 3.412
cfm	=m <sup>3</sup> /min x 35.31
lbs	=kg/0.4536

Due to continuing improvement, above specifications may be subject to change without notice.

\*Above specification data is subject to rounding variation.



1. SPECIFICATIONS

Outdoor Model		PUHY-HP240TSNU-A	
Indoor Model		Non-Ducted	Ducted
Power source		3-phase 3-wire 208-230 V ±10% 60 Hz	
Cooling capacity (Nominal)	*1	BTU/h	240,000
		kW	70.3
(208-230)	Power input	kW	19.37
	Current input	A	59.7-54.0
(Rated)		BTU/h	230,000
		kW	67.4
(208-230)	Power input	kW	22.50
	Current input	A	69.3-62.7
Temp. range of cooling	Indoor	W.B.	59~75 F (15~24°C)
	Outdoor	D.B.	23~126 F (-5~52°C)
Heating capacity (Nominal)	*2	BTU/h	270,000
		kW	79.1
(208-230)	Power input	kW	21.38
	Current input	A	65.9-59.6
(Rated)		BTU/h	258,000
		kW	75.6
(208-230)	Power input	kW	19.52
	Current input	A	60.2-54.4
Temp. range of heating	Indoor	D.B.	59~81 F (15~27°C)
	Outdoor	W.B.	-22~60 F (-30~15.5°C)
Indoor unit connectable	Total capacity	50~130% of outdoor unit capacity	
	Model/Quantity	P04~P96 / 2~50	
Sound power level (measured in anechoic room) *3		dB (A)	83.0 / 84.0
Refrigerant piping diameter	Liquid pipe	in. (mm)	5/8 (15.88) Brazed
	Gas pipe	in. (mm)	1-1/8 (28.58) Brazed

Set Model		PUHY-HP120TNU-A	PUHY-HP120TNU-A	
Model		PUHY-HP120TNU-A	PUHY-HP120TNU-A	
Minimum Circuit Ampacity	A	66-60	66-60	
Maximum Overcurrent Protection	A	110-100	110-100	
FAN	Type x Quantity	Propeller fan x 2		
	Airflow rate	cfm	7750 / 7750	
		m <sup>3</sup> /min	220 / 220	
	*3	L/s	3670 / 3670	
	Control, Driving mechanism	Inverter-control , Brushless DC motor		
*4	Motor output	kW	0.46 + 0.46	
	External static press.	0 in.WG (0 Pa)		
Compressor	Type x Quantity	Inverter scroll hermetic compressor x 1		
	Starting method	Inverter		
	Motor output	kW	6.5 x 1	
	Case heater	kW	-	
	Lubricant	MEL46		
External finish		Pre-coated galvanized steel sheet <MUNSELL 3Y 7.8/1.1 or similar>	Pre-coated galvanized steel sheet <MUNSELL 3Y 7.8/1.1 or similar>	
External dimension H x W x D	in.	71-5/8 x 48-7/8 x 29-3/16	71-5/8 x 48-7/8 x 29-3/16	
	mm	1818 x 1240 x 740	1818 x 1240 x 740	
	Protection devices	High pressure protection	High pressure sensor , High pressure switch at 4.15 MPa (601 psi)	High pressure sensor , High pressure switch at 4.15 MPa (601 psi)
		Inverter circuit (COMP./FAN)	Over-heat protection , Over-current protection	Over-heat protection , Over-current protection
Refrigerant	Compressor	-	-	
	Fan motor	-	-	
	Type x original charge	R410A x 23 lbs + 12 oz (10.8kg)		
Control	LEV and HIC circuit			
Net weight	lbs (kg)	655 (297)	655 (297)	
Heat exchanger		Salt-resistant cross fin & copper tube	Salt-resistant cross fin & copper tube	
HIC circuit (HIC: Heat Inter-Changer)		Copper pipe , tube-in-tube structure	Copper pipe , tube-in-tube structure	
Pipe between unit and distributor	Liquid pipe	in. (mm)	1/2 (12.7) Brazed	
	Gas pipe	in. (mm)	1-1/8 (28.58) Brazed	
Defrosting method		Auto-defrost mode (Reversed refrigerant cycle)		
Drawing	External	KB94C0GN		
	Wiring	KE94G811	KE94G811	
Standard attachment	Document	Installation Manual		
	Accessory	Band		
Optional parts		Outdoor Twinning kit : CMY-Y100CBK3 joint : CMY-Y102SS/102LS-G2 , CMY-Y202S/302S-G2 Header : CMY-Y104/108/1010C-G		

Remarks  
Details on foundation work, duct work, insulation work, electrical wiring, power source switch, and other items shall be referred to the Installation Manual.

- Notes:
- Nominal cooling conditions (Test conditions are based on AHRI 1230)  
Indoor: 80 °FD.B./67 °FW.B. (26.7 °CD.B./19.4 °CW.B.), Outdoor: 95 °FD.B. (35 °CD.B.)
  - Nominal heating conditions (Test conditions are based on AHRI 1230)  
Indoor: 70 °FD.B. (21.1 °CD.B.), Outdoor: 47 °FD.B./43 °FW.B. (8.3 °CD.B./6.1 °CW.B.)
  - Cooling mode / Heating mode
  - External static pressure option is available (0.12 in.WG, 0.24 in.WG, 0.32 in.WG/30 Pa, 60 Pa, 80 Pa).

Unit converter	
BTU/h	=kW x 3.412
cfm	=m <sup>3</sup> /min x 35.31
lbs	=kg/0.4536

Due to continuing improvement, above specifications may be subject to change without notice.

\*Above specification data is subject to rounding variation.

1. SPECIFICATIONS

PUHY-HP-T(S)NU-A, Y(S)NU-A

Outdoor Model		PUHY-HP72YNU-A	
Indoor Model		Non-Ducted	Ducted
Power source		3-phase 3-wire 460 V ±10% 60 Hz	
Cooling capacity (Nominal)	*1	BTU/h	72,000
		kW	21.1
(460)	Power input	kW	5.39
	Current input	A	7.5
(Rated)		BTU/h	69,000
		kW	20.2
(460)	Power input	kW	5.44
	Current input	A	7.5
Temp. range of cooling	Indoor	W.B.	59~75 F (15~24°C)
	Outdoor	D.B.	23~126 F (-5~52°C)
Heating capacity (Nominal)	*2	BTU/h	80,000
		kW	23.4
(460)	Power input	kW	5.33
	Current input	A	7.4
(Rated)		BTU/h	76,000
		kW	22.3
(460)	Power input	kW	4.83
	Current input	A	6.7
Temp. range of heating	Indoor	D.B.	59~81 F (15~27°C)
	Outdoor	W.B.	-22~60 F (-30~15.5°C)
Indoor unit connectable		Total capacity 50~130% of outdoor unit capacity Model/Quantity P04~P72 / 1~18	
Sound power level (measured in anechoic room) *3		dB (A) 74.0 / 76.0	
Refrigerant piping diameter	Liquid pipe	in. (mm)	3/8 (9.52) Brazed
	Gas pipe	in. (mm)	7/8 (22.2) Brazed
Minimum Circuit Ampacity		A 25	
Maximum Overcurrent Protection		A 40	
FAN	Type x Quantity		Propeller fan x 2
	Airflow rate	cfm	6700 / 6700
		m <sup>3</sup> /min	190 / 190
	*3	L/s	3170 / 3170
Control, Driving mechanism		Inverter-control, Brushless DC motor	
*4	Motor output	kW	0.46 + 0.46
	External static press.		0 in.WG (0 Pa)
Compressor	Type x Quantity		Inverter scroll hermetic compressor x 1
	Starting method		Inverter
	Motor output	kW	3.8 x 1
	Case heater	kW	-
Lubricant		MEL46	
External finish		Pre-coated galvanized steel sheet <MUNSELL 3Y 7.8/1.1 or similar>	
External dimension H x W x D		in.	71-5/8 x 48-7/8 x 29-3/16
		mm	1818 x 1240 x 740
Protection devices	High pressure protection		High pressure sensor, High pressure switch at 4.15 MPa (601 psi)
	Inverter circuit (COMP./FAN)		Over-heat protection, Over-current protection
	Compressor		-
	Fan motor		-
Refrigerant	Type x original charge		R410A x 21 lbs + 9 oz (9.8 kg)
	Control		LEV and HIC circuit
Net weight		lbs (kg)	644 (292)
Heat exchanger		Salt-resistant cross fin & copper tube	
HIC circuit (HIC: Heat Inter-Changer)		Copper pipe, tube-in-tube structure	
Defrosting method		Auto-defrost mode (Reversed refrigerant cycle)	
Drawing	External		KB94C0GP
	Wiring		KE94G817
Standard attachment	Document		Installation Manual
	Accessory		Band
Optional parts		joint : CMY-Y102SS/102LS-G2 Header : CMY-Y104/108/1010C-G	
Remarks Details on foundation work, duct work, insulation work, electrical wiring, power source switch, and other items shall be referred to the Installation Manual.			
Notes: 1.Nominal cooling conditions (Test conditions are based on AHRI 1230) Indoor: 80 °FD.B./67 °FW.B. (26.7 °CD.B./19.4 °CW.B.), Outdoor: 95 °FD.B. (35 °CD.B.) 2.Nominal heating conditions (Test conditions are based on AHRI 1230) Indoor: 70 °FD.B. (21.1 °CD.B.), Outdoor: 47 °FD.B./43 °FW.B. (8.3 °CD.B./6.1 °CW.B.) 3.Cooling mode / Heating mode 4.External static pressure option is available (0.12 in.WG, 0.24 in.WG, 0.32 in.WG/30 Pa, 60 Pa, 80 Pa).			Unit converter BTU/h =kW x 3,412 cfm =m <sup>3</sup> /min x 35.31 lbs =kg/0.4536
Due to continuing improvement, above specifications may be subject to change without notice.			*Above specification data is subject to rounding variation.

# 1. SPECIFICATIONS

Outdoor Model		PUHY-HP96YNU-A			
Indoor Model		Non-Ducted	Ducted		
Power source		3-phase 3-wire 460 V ±10% 60 Hz			
Cooling capacity (Nominal)	*1	BTU/h	96,000		
		kW	28.1		
	(460)	Power input	kW	6.23	
		Current input	A	8.6	
	(Rated)		BTU/h	92,000	
			kW	27.0	
(460)	Power input	kW	7.25	7.19	
	Current input	A	10.1	10.0	
	Temp. range of cooling		Indoor	W.B.	59~75 F (15~24°C)
			Outdoor	D.B.	23~126 F (-5~52°C)
Heating capacity (Nominal)	*2	BTU/h	108,000		
		kW	31.7		
	(460)	Power input	kW	7.33	
		Current input	A	10.2	
	(Rated)		BTU/h	103,000	
			kW	30.2	
(460)	Power input	kW	6.65	6.86	
	Current input	A	9.2	9.5	
	Temp. range of heating		Indoor	D.B.	59~81 F (15~27°C)
			Outdoor	W.B.	-22~60 F (-30~15.5°C)
Indoor unit connectable		Total capacity	50~130% of outdoor unit capacity		
		Model/Quantity	P04~P96 / 1~24		
Sound power level (measured in anechoic room) *3		dB (A)	76.0 / 77.5		
Refrigerant piping diameter	Liquid pipe	in. (mm)	3/8 (9.52) Brazed (1/2(12.7) Brazed, the farthest pipe length ≥90m)		
	Gas pipe	in. (mm)	7/8 (22.2) Brazed		
Minimum Circuit Ampacity		A	29		
Maximum Overcurrent Protection		A	45		
FAN	Type x Quantity		Propeller fan x 2		
	Airflow rate	cfm	7400 / 7400		
		m <sup>3</sup> /min	210 / 210		
		*3 L/s	3500 / 3500		
	Control, Driving mechanism		Inverter-control , Brushless DC motor		
Compressor	*4	Motor output	kW		0.46 + 0.46
		External static press.	0 in.WG (0 Pa)		
	Type x Quantity		Inverter scroll hermetic compressor x 1		
Starting method		Inverter			
Motor output		kW	4.5 x 1		
Case heater		kW	-		
Lubricant		MEL46			
External finish		Pre-coated galvanized steel sheet			
		<MUNSELL 3Y 7.8/1.1 or similar>			
External dimension H x W x D		in.	71-5/8 x 48-7/8 x 29-3/16		
		mm	1818 x 1240 x 740		
Protection devices	High pressure protection		High pressure sensor , High pressure switch at 4.15 MPa (601 psi)		
	Inverter circuit (COMP./FAN)		Over-heat protection , Over-current protection		
	Compressor		-		
	Fan motor		-		
Refrigerant	Type x original charge		R410A x 23 lbs + 12 oz (10.8kg)		
	Control		LEV and HIC circuit		
Net weight		lbs (kg)	688 (312)		
Heat exchanger		Salt-resistant cross fin & copper tube			
HIC circuit (HIC: Heat Inter-Changer)		Copper pipe , tube-in-tube structure			
Defrosting method		Auto-defrost mode (Reversed refrigerant cycle)			
Drawing	External		KB94C0GP		
	Wiring		KE94G817		
Standard attachment	Document		Installation Manual		
	Accessory		Band		
Optional parts		joint : CMY-Y102SS/102LS-G2 Header : CMY-Y104/108/1010C-G			
Remarks					
Details on foundation work, duct work, insulation work, electrical wiring, power source switch, and other items shall be referred to the Installation Manual.					
Notes:			Unit converter		
1.Nominal cooling conditions (Test conditions are based on AHRI 1230) Indoor: 80 °FD.B./67 °FW.B. (26.7 °CD.B./19.4 °CW.B.), Outdoor: 95 °FD.B. (35 °CD.B.)			BTU/h =kW x 3,412		
2.Nominal heating conditions (Test conditions are based on AHRI 1230) Indoor: 70 °FD.B. (21.1 °CD.B.), Outdoor: 47 °FD.B./43 °FW.B. (8.3 °CD.B./6.1 °CW.B.)			cfm =m <sup>3</sup> /min x 35.31		
3.Cooling mode / Heating mode			lbs =kg/0.4536		
4.External static pressure option is available (0.12 in.WG, 0.24 in.WG, 0.32 in.WG/30 Pa, 60 Pa, 80 Pa).					
Due to continuing improvement, above specifications may be subject to change without notice.				*Above specification data is subject to rounding variation.	

1. SPECIFICATIONS

PUHY-HP-T(S)NU-A, Y(S)NU-A

Outdoor Model		PUHY-HP120YNU-A		
Indoor Model		Non-Ducted	Ducted	
Power source		3-phase 3-wire 460 V ±10% 60 Hz		
Cooling capacity (Nominal)	*1	BTU/h	120,000	
		kW	35.2	
	(460)	Power input	kW	8.53
		Current input	A	11.8
	(Rated)		BTU/h	115,000
			kW	33.7
(460)	Power input	kW	10.13	9.72
	Current input	A	14.1	13.5
	Temp. range of cooling		Indoor W.B. 59~75 F (15~24°C) Outdoor D.B. 23~126 F (-5~52°C)	
	Heating capacity (Nominal)		*2	
(460)		BTU/h	135,000	
		kW	39.6	
	(Rated)	Power input	kW	9.63
		Current input	A	13.4
	(460)		BTU/h	129,000
			kW	37.8
(460)	Power input	kW	8.55	9.17
	Current input	A	11.9	12.7
	Temp. range of heating		Indoor D.B. 59~81 F (15~27°C) Outdoor W.B. -22~60 F (-30~15.5°C)	
	Indoor unit connectable		Total capacity 50~130% of outdoor unit capacity Model/Quantity P04~P96 / 1~30	
Sound power level (measured in anechoic room) *3		dB (A) 79.5 / 80.5		
Refrigerant piping diameter		Liquid pipe in. (mm) 3/8 (9.52) Brazed(1/2(12.7) Brazed, the farthest pipe length ≥40m) Gas pipe in. (mm) 1-1/8 (28.58) Brazed		
Minimum Circuit Ampacity		A 35		
Maximum Overcurrent Protection		A 50		
FAN		Type x Quantity Propeller fan x 2		
Airflow rate		cfm	7750 / 7750	
		m <sup>3</sup> /min	220 / 220	
		*3 L/s	3670 / 3670	
Control, Driving mechanism		Inverter-control , Brushless DC motor		
Motor output		kW 0.46 + 0.46		
*4 External static press.		0 in.WG (0 Pa)		
Compressor		Type x Quantity Inverter scroll hermetic compressor x 1		
Starting method		Inverter		
Motor output		kW 6.5 x 1		
Case heater		kW -		
Lubricant		MEL46		
External finish		Pre-coated galvanized steel sheet <MUNSELL 3Y 7.8/1.1 or similar>		
External dimension H x W x D		in. 71-5/8 x 48-7/8 x 29-3/16 mm 1818 x 1240 x 740		
Protection devices		High pressure protection High pressure sensor , High pressure switch at 4.15 MPa (601 psi) Inverter circuit (COMP./FAN) Over-heat protection , Over-current protection Compressor - Fan motor -		
Refrigerant		Type x original charge R410A x 23 lbs + 12 oz (10.8kg) Control LEV and HIC circuit		
Net weight		lbs (kg) 691 (313)		
Heat exchanger		Salt-resistant cross fin & copper tube		
HIC circuit (HIC: Heat Inter-Changer)		Copper pipe , tube-in-tube structure		
Defrosting method		Auto-defrost mode (Reversed refrigerant cycle)		
Drawing		External KB94C0GP Wiring KE94G817		
Standard attachment		Document Installation Manual Accessory Band		
Optional parts		joint : CMY-Y102SS/102LS-G2, CMY-Y202S-G2 Header : CMY-Y104/108/1010C-G		
Remarks Details on foundation work, duct work, insulation work, electrical wiring, power source switch, and other items shall be referred to the Installation Manual.				
Notes:		Unit converter		
1.Nominal cooling conditions (Test conditions are based on AHRI 1230) Indoor: 80 °FD.B./67 °FW.B. (26.7 °CD.B./19.4 °CW.B.), Outdoor: 95 °FD.B. (35 °CD.B.)		BTU/h =kW x 3,412		
2.Nominal heating conditions (Test conditions are based on AHRI 1230) Indoor: 70 °FD.B. (21.1 °CD.B.), Outdoor: 47 °FD.B./43 °FW.B. (8.3 °CD.B./6.1 °CW.B.)		cfm =m <sup>3</sup> /min x 35.31		
3.Cooling mode / Heating mode		lbs =kg/0.4536		
4.External static pressure option is available (0.12 in.WG, 0.24 in.WG, 0.32 in.WG/30 Pa, 60 Pa, 80 Pa).				
Due to continuing improvement, above specifications may be subject to change without notice.				
*Above specification data is subject to rounding variation.				

1. SPECIFICATIONS

Outdoor Model	PUHY-HP144YSNU-A			
Indoor Model	Non-Ducted		Ducted	
Power source	3-phase 3-wire 460 V ±10% 60 Hz			
Cooling capacity (Nominal)	*1	BTU/h	144,000	
		kW	42.2	
	(460)	Power input	kW	12.20
		Current input	A	17.0
	(Rated)		BTU/h	138,000
			kW	40.4
(460)	Power input	kW	11.73	
	Current input	A	16.3	
Temp. range of cooling	Indoor	W.B.	59~75 F (15~24°C)	
	Outdoor	D.B.	23~126 F (-5~52°C)	
Heating capacity (Nominal)	*2	BTU/h	160,000	
		kW	46.9	
	(460)	Power input	kW	11.70
		Current input	A	16.3
	(Rated)		BTU/h	152,000
			kW	44.5
(460)	Power input	kW	10.50	
	Current input	A	14.6	
Temp. range of heating	Indoor	D.B.	59~81 F (15~27°C)	
	Outdoor	W.B.	-22~60 F (-30~15.5°C)	
Indoor unit connectable	Total capacity	50~130% of outdoor unit capacity		
	Model/Quantity	P04~P96 / 1~36		
Sound power level (measured in anechoic room) *3	dB (A)	77.5 / 79.5		
Refrigerant piping diameter	Liquid pipe	in. (mm)	1/2 (12.7) Brazed	
	Gas pipe	in. (mm)	1-1/8 (28.58) Brazed	

Set Model				
Model	PUHY-HP72YNU-A		PUHY-HP72YNU-A	
Minimum Circuit Ampacity	A	25	25	
Maximum Overcurrent Protection	A	40	40	
FAN	Type x Quantity	Propeller fan × 2		
	Airflow rate	cfm	6700 / 6700	
		m <sup>3</sup> /min	190 / 190	
	*3	L/s	3170 / 3170	
		Control, Driving mechanism	Inverter-control , Brushless DC motor	
	*4	Motor output	kW	0.46 + 0.46
External static press.		0 in.WG (0 Pa)		
Compressor	Type x Quantity	Inverter scroll hermetic compressor× 1		
	Starting method	Inverter		
	Motor output	kW	3.8× 1	
	Case heater	kW	—	
	Lubricant	MEL46		
External finish	Pre-coated galvanized steel sheet <MUNSELL 3Y 7.8/1.1 or similar>		Pre-coated galvanized steel sheet <MUNSELL 3Y 7.8/1.1 or similar>	
External dimension H x W x D	in.	71-5/8 x 48-7/8 x 29-3/16	71-5/8 x 48-7/8 x 29-3/16	
	mm	1818 x 1240 x 740	1818 x 1240 x 740	
	Protection devices	High pressure protection	High pressure sensor , High pressure switch at 4.15 MPa (601 psi)	High pressure sensor , High pressure switch at 4.15 MPa (601 psi)
		Inverter circuit (COMP./FAN)	Over-heat protection , Over-current protection	Over-heat protection , Over-current protection
Refrigerant	Compressor	—		
	Fan motor	—		
	Type x original charge	R410A × 21 lbs + 9 oz (9.8 kg)		
Control	LEV and HIC circuit			
Net weight	lbs (kg)	644 (292)	644 (292)	
Heat exchanger	Salt-resistant cross fin & copper tube			
HIC circuit (HIC: Heat Inter-Changer)	Copper pipe , tube-in-tube structure			
Pipe between unit and distributor	Liquid pipe	in. (mm)	3/8 (9.52) Brazed	
	Gas pipe	in. (mm)	7/8 (22.2) Brazed	
Defrosting method	Auto-defrost mode (Reversed refrigerant cycle)			
Drawing	External	KB94C0GQ		
	Wiring	KE94G817		
Standard attachment	Document	Installation Manual		
	Accessory	Band		
Optional parts	Outdoor Twinning kit : CMY-Y100CBK3 joint : CMY-Y102SS/102LS-G2 , CMY-Y202S-G2 Header : CMY-Y104/108/1010C-G			

Remarks  
Details on foundation work, duct work, insulation work, electrical wiring, power source switch, and other items shall be referred to the Installation Manual.

- Notes:
- Nominal cooling conditions (Test conditions are based on AHRI 1230)  
Indoor: 80 °FD.B./67 °FW.B. (26.7 °CD.B./19.4 °CW.B.), Outdoor: 95 °FD.B. (35 °CD.B.)
  - Nominal heating conditions (Test conditions are based on AHRI 1230)  
Indoor: 70 °FD.B. (21.1 °CD.B.), Outdoor: 47 °FD.B./43 °FW.B. (8.3 °CD.B./6.1 °CW.B.)
  - Cooling mode / Heating mode
  - External static pressure option is available (0.12 in.WG, 0.24 in.WG, 0.32 in.WG/30 Pa, 60 Pa, 80 Pa).

Unit converter	
BTU/h	=kW x 3.412
cfm	=m <sup>3</sup> /min x 35.31
lbs	=kg/0.4536

Due to continuing improvement, above specifications may be subject to change without notice.

\*Above specification data is subject to rounding variation.



1. SPECIFICATIONS

PUHY-HP-T(S)NU-A, Y(S)NU-A

Outdoor Model		PUHY-HP192YSNU-A		
Indoor Model		Non-Ducted	Ducted	
Power source		3-phase 3-wire 460 V ±10% 60 Hz		
Cooling capacity (Nominal)	*1	BTU/h	192,000	
		kW	56.3	
	(460)	Power input	kW	13.79
		Current input	A	19.2
		(Rated)	BTU/h	184,000
		kW	53.9	
(460)	Power input	kW	15.79	15.27
	Current input	A	22.0	21.2
	Temp. range of cooling	Indoor	W.B.	59~75° F (15~24°C)
	Outdoor	D.B.	23~126° F (-5~52°C)	
Heating capacity (Nominal)	*2	BTU/h	215,000	
		kW	63.0	
	(460)	Power input	kW	15.91
		Current input	A	22.1
		(Rated)	BTU/h	206,000
		kW	60.4	
(460)	Power input	kW	14.39	14.79
	Current input	A	20.0	20.6
	Temp. range of heating	Indoor	D.B.	59~81° F (15~27°C)
	Outdoor	W.B.	-22~60° F (-30~15.5°C)	
Indoor unit connectable		Total capacity 50~130% of outdoor unit capacity		
Model/Quantity		P04~P96 / 1~48		
Sound power level (measured in anechoic room) *3		dB (A)		
		79.5 / 81.0		
Refrigerant piping diameter		Liquid pipe in. (mm) 5/8 (15.88) Brazed		
		Gas pipe in. (mm) 1-1/8 (28.58) Brazed		

Set Model		PUHY-HP96YNU-A	PUHY-HP96YNU-A	
Model		PUHY-HP96YNU-A	PUHY-HP96YNU-A	
Minimum Circuit Ampacity		A 29	29	
Maximum Overcurrent Protection		A 45	45	
FAN	Type x Quantity	Propeller fan x 2	Propeller fan x 2	
	Airflow rate	cfm	7400 / 7400	7400 / 7400
		m <sup>3</sup> /min	210 / 210	210 / 210
	*3	L/s	3500 / 3500	3500 / 3500
	Control, Driving mechanism	Inverter-control , Brushless DC motor	Inverter-control , Brushless DC motor	
	Motor output	kW 0.46 + 0.46	0.46 + 0.46	
*4	External static press.	0 in.WG (0 Pa)	0 in.WG (0 Pa)	
Compressor	Type x Quantity	Inverter scroll hermetic compressor x 1	Inverter scroll hermetic compressor x 1	
	Starting method	Inverter	Inverter	
	Motor output	kW 4.5 x 1	4.5 x 1	
	Case heater	kW -	-	
	Lubricant	MEL46	MEL46	
External finish		Pre-coated galvanized steel sheet <MUNSELL 3Y 7.8/1.1 or similar>	Pre-coated galvanized steel sheet <MUNSELL 3Y 7.8/1.1 or similar>	
External dimension H x W x D		in. 71-5/8 x 48-7/8 x 29-3/16	71-5/8 x 48-7/8 x 29-3/16	
		mm 1818 x 1240 x 740	1818 x 1240 x 740	
Protection devices	High pressure protection	High pressure sensor , High pressure switch at 4.15 MPa (601 psi)	High pressure sensor , High pressure switch at 4.15 MPa (601 psi)	
	Inverter circuit (COMP./FAN)	Over-heat protection , Over-current protection	Over-heat protection , Over-current protection	
	Compressor	-	-	
	Fan motor	-	-	
Refrigerant	Type x original charge	R410A x 23 lbs + 12 oz (10.8kg)	R410A x 23 lbs + 12 oz (10.8kg)	
	Control	LEV and HIC circuit	LEV and HIC circuit	
Net weight		lbs (kg) 688 (312)	688 (312)	
Heat exchanger		Salt-resistant cross fin & copper tube	Salt-resistant cross fin & copper tube	
HIC circuit (HIC: Heat Inter-Changer)		Copper pipe , tube-in-tube structure	Copper pipe , tube-in-tube structure	
Pipe between unit and distributor	Liquid pipe	in. (mm) 3/8 (9.52) Brazed	3/8 (9.52) Brazed	
	Gas pipe	in. (mm) 7/8 (22.2) Brazed	7/8 (22.2) Brazed	
Defrosting method		Auto-defrost mode (Reversed refrigerant cycle)		
Drawing	External	KB94C0GQ		
	Wiring	KE94G817	KE94G817	
Standard attachment	Document	Installation Manual		
	Accessory	Band		
Optional parts		Outdoor Twinning kit : CMY-Y100CBK3 joint : CMY-Y102SS/102LS-G2 , CMY-Y202S/302S-G2 Header : CMY-Y104/108/1010C-G		

Remarks  
Details on foundation work, duct work, insulation work, electrical wiring, power source switch, and other items shall be referred to the Installation Manual.

- Notes:
- Nominal cooling conditions (Test conditions are based on AHRI 1230)  
Indoor: 80 °FD.B./67 °FW.B. (26.7 °CD.B./19.4 °CW.B.), Outdoor: 95 °FD.B. (35 °CD.B.)
  - Nominal heating conditions (Test conditions are based on AHRI 1230)  
Indoor: 70 °FD.B. (21.1 °CD.B.), Outdoor: 47 °FD.B./43 °FW.B. (8.3 °CD.B./6.1 °CW.B.)
  - Cooling mode / Heating mode
  - External static pressure option is available (0.12 in.WG, 0.24 in.WG, 0.32 in.WG/30 Pa, 60 Pa, 80 Pa).

Unit converter	
BTU/h	=kW x 3.412
cfm	=m <sup>3</sup> /min x 35.31
lbs	=kg/0.4536

Due to continuing improvement, above specifications may be subject to change without notice.

\*Above specification data is subject to rounding variation.

1. SPECIFICATIONS

Outdoor Model		PUHY-HP240YSNU-A		
Indoor Model		Non-Ducted	Ducted	
Power source		3-phase 3-wire 460 V ±10% 60 Hz		
Cooling capacity (Nominal)	*1	BTU/h	240,000	
		kW	70.3	
	(460)	Power input	kW	19.37
		Current input	A	27.0
	(Rated)		BTU/h	230,000
			kW	67.4
(460)	Power input	kW	22.50	
	Current input	A	31.3	
			59~75 F (15~24°C)	
			23~126 F (-5~52°C)	
Heating capacity (Nominal)	*2	BTU/h	270,000	
		kW	79.1	
	(460)	Power input	kW	21.38
		Current input	A	29.8
	(Rated)		BTU/h	258,000
			kW	75.6
(460)	Power input	kW	19.52	
	Current input	A	27.2	
Temp. range of heating	Indoor	D.B.	59~81 F (15~27°C)	
	Outdoor	W.B.	-22~60 F (-30~15.5°C)	
Indoor unit connectable	Total capacity	50~130% of outdoor unit capacity		
	Model/Quantity	P04~P96 / 2~50		
Sound power level (measured in anechoic room) *3		dB (A)		
		83.0 / 84.0		
Refrigerant piping diameter	Liquid pipe	in. (mm)	5/8 (15.88) Brazed	
	Gas pipe	in. (mm)	1-1/8 (28.58) Brazed	
Set Model				
Model		PUHY-HP120YNU-A	PUHY-HP120YNU-A	
Minimum Circuit Ampacity		A	35	
Maximum Overcurrent Protection		A	50	
FAN	Type x Quantity	Propeller fan x 2		
	Airflow rate	cfm	7750 / 7750	
		m <sup>3</sup> /min	220 / 220	
		L/s	3670 / 3670	
	Control, Driving mechanism	Inverter-control , Brushless DC motor		
	*4	Motor output	kW	0.46 + 0.46
	External static press.	0 in.WG (0 Pa)		
Compressor	Type x Quantity	Inverter scroll hermetic compressor x 1		
	Starting method	Inverter		
	Motor output	kW	6.5 x 1	
	Case heater	kW	-	
	Lubricant	MEL46		
External finish		Pre-coated galvanized steel sheet <MUNSELL 3Y 7.8/1.1 or similar>		
External dimension H x W x D		in.	71-5/8 x 48-7/8 x 29-3/16	
		mm	1818 x 1240 x 740	
Protection devices	High pressure protection	High pressure sensor , High pressure switch at 4.15 MPa (601 psi)		
	Inverter circuit (COMP./FAN)	Over-heat protection , Over-current protection		
	Compressor	-		
	Fan motor	-		
Refrigerant	Type x original charge	R410A x 23 lbs + 12 oz (10.8kg)		
	Control	LEV and HIC circuit		
Net weight		lbs (kg)	691 (313)	
Heat exchanger		Salt-resistant cross fin & copper tube		
HIC circuit (HIC: Heat Inter-Changer)		Copper pipe , tube-in-tube structure		
Pipe between unit and distributor	Liquid pipe	in. (mm)	1/2 (12.7) Brazed	
	Gas pipe	in. (mm)	1-1/8 (28.58) Brazed	
Defrosting method		Auto-defrost mode (Reversed refrigerant cycle)		
Drawing	External	KB94C0GQ		
	Wiring	KE94G817		
Standard attachment	Document	Installation Manual		
	Accessory	Band		
Optional parts		Outdoor Twinning kit : CMY-Y100CBK3 joint : CMY-Y102SS/102LS-G2 , CMY-Y202S/302S-G2 Header : CMY-Y104/108/1010C-G		
Remarks Details on foundation work, duct work, insulation work, electrical wiring, power source switch, and other items shall be referred to the Installation Manual.				
Notes: 1.Nominal cooling conditions (Test conditions are based on AHRI 1230) Indoor: 80 °FD.B./67 °FW.B. (26.7 °CD.B./19.4 °CW.B.), Outdoor: 95 °FD.B. (35 °CD.B.) 2.Nominal heating conditions (Test conditions are based on AHRI 1230) Indoor: 70 °FD.B. (21.1 °CD.B.), Outdoor: 47 °FD.B./43 °FW.B. (8.3 °CD.B./6.1 °CW.B.) 3.Cooling mode / Heating mode 4.External static pressure option is available (0.12 in.WG, 0.24 in.WG, 0.32 in.WG/30 Pa, 60 Pa, 80 Pa).			Unit converter BTU/h =kW x 3,412 cfm =m <sup>3</sup> /min x 35.31 lbs =kg/0.4536	
Due to continuing improvement, above specifications may be subject to change without notice.				
*Above specification data is subject to rounding variation.				

PUHY-HP-T(S)NU-A, Y(S)NU-A





PUHY-HP72, 96, 120TNU-A

Unit: mm (in.)

1. Required space around the unit

● In case of single installation

- ① Secure enough space around the unit as shown in the figure below.

With a space of at least 450mm(17-3/4) to the wall on the back of the unit

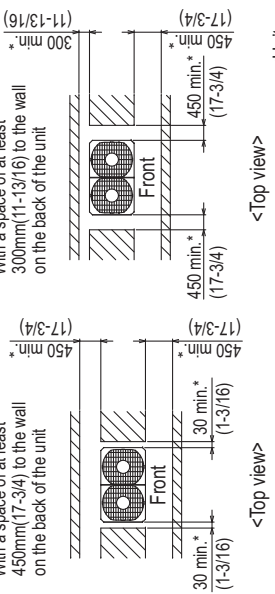

- ② When the height of the walls on the front, back or on the sides<H> exceeds the wall height limit as defined below add the height that exceeds the height limit <h> to the figures that are marked with an asterisk.

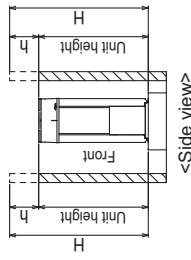

<Wall height limit> Front : Up to the unit height  
Back : Up to the unit height  
Side : Up to the unit height

2. Foundation work

- ① Take into consideration the surface strength, water drainage route, piping route, and wiring route when preparing the installation site.  
<Note that the drain water comes out of the unit during operation.>
- ② Build the foundation in such way that the corner of the installation leg is securely supported as shown in the right figure.(Fig.A)  
When using a rubber isolating cushion, please ensure it is large enough to cover the entire width of each of the unit's legs.
- ③ The protrusion length of the anchor bolt must not exceed 30mm(1-3/16).(Fig.A)
- ④ Use four fixing plates as shown in the right figure <field supply required> when using M12 hole-in anchor bolts <field supply required>.(Fig.B)
- ⑤ To prevent small animals and water and snow from entering the unit and damaging its parts, close the gap around the edges of through holes for pipes and wires with filler plates <field supply required>.
- ⑥ When the pipes or cables are routed at the bottom of the unit, make sure that the through hole at the base of the unit does not get blocked with the installation base.
- ⑦ Refer to the Installation Manual when installing units on an installation base.

● In case of collective installation

- ① When multiple units are installed adjacent to each other, secure enough space to allow for air circulation and walkway between groups of units as shown in the figures below.
- ② At least two sides must be left open.
- ③ As with the single installation, add the height that exceeds the height limit<h> to the figures that are marked with an asterisk.
- ④ If there is a wall at both the front and the rear of the unit, install up to six units consecutively in the side direction and provide a space of 1000mm(39-3/8) or more as inlet space/ passage space for each six units.

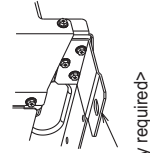
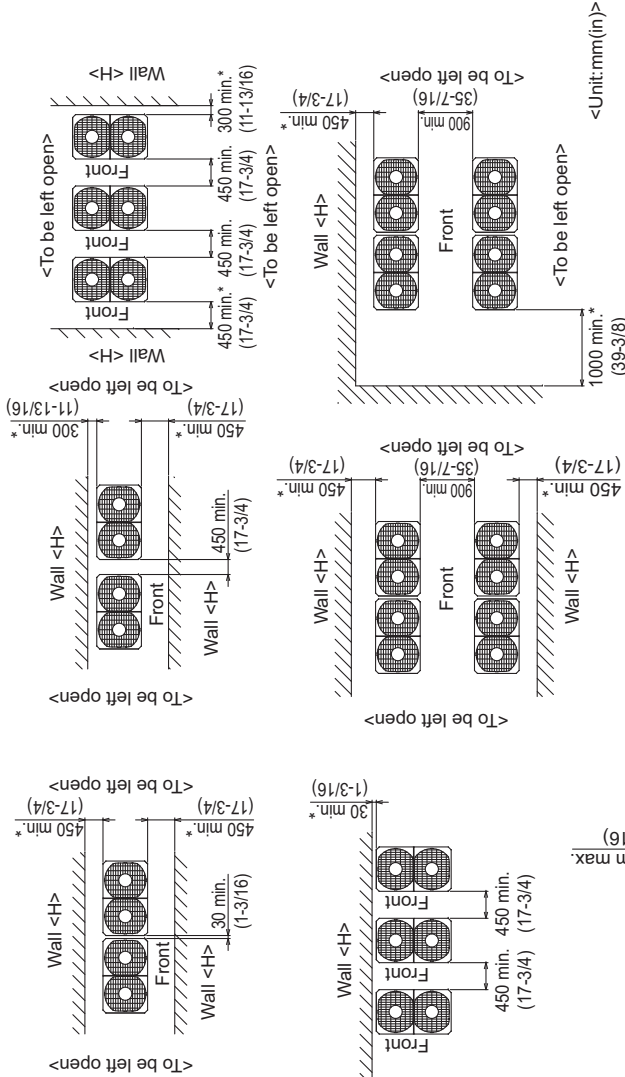

Fig.B  
Fixing plate  
<field supply required>

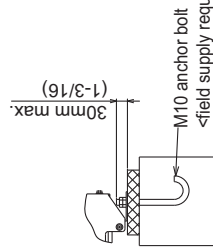
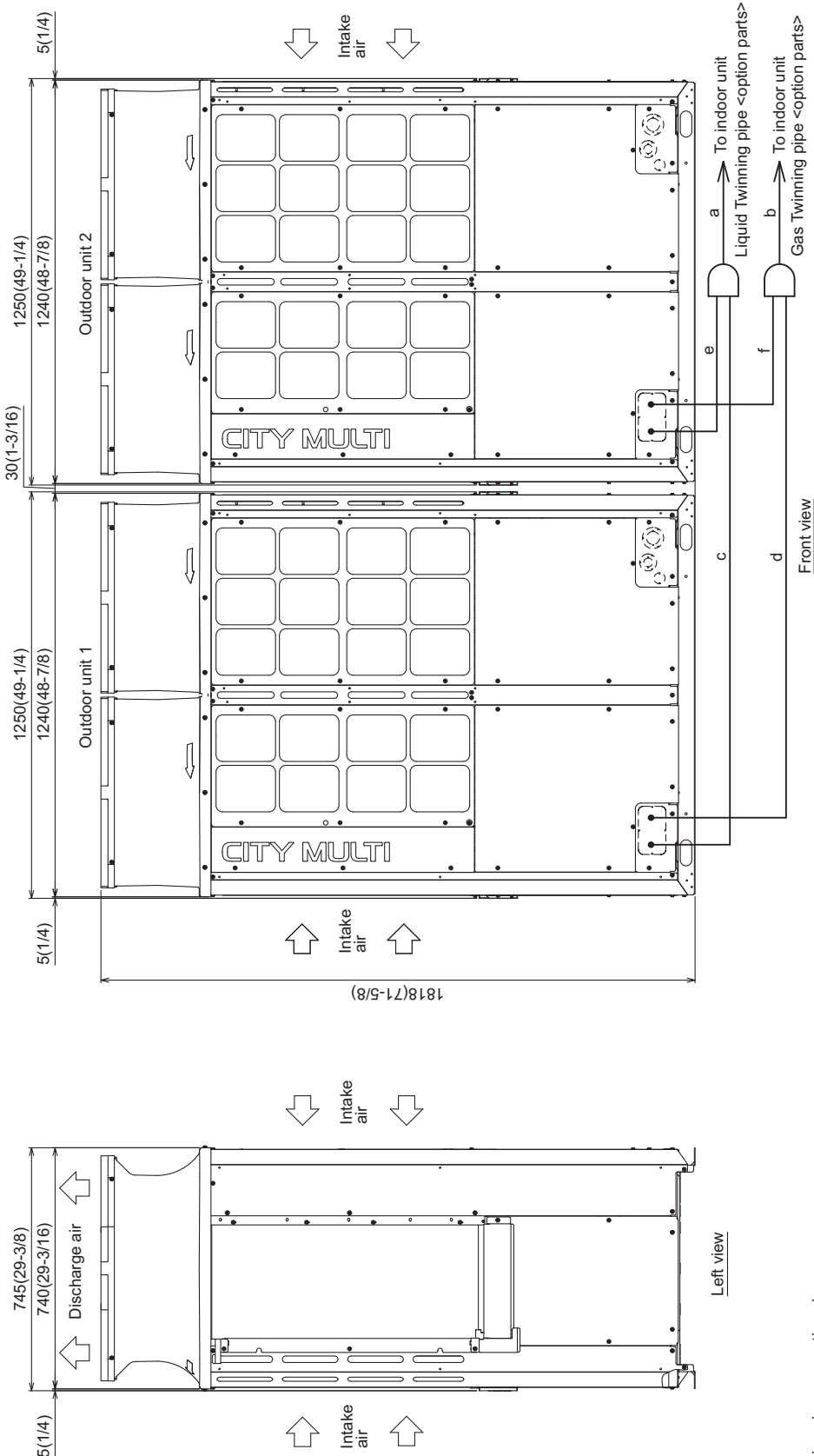

Fig.A  
M10 anchor bolt  
<field supply required>

PUHY-HP144, 192, 240TSNU-A

Unit: mm (in.)



Unit model	Liquid core	Gas diameter
HP72	ø9.52(3/8)	ø22.2(7/8)
HP96	ø12.7(1/2)	ø28.58(1-1/8)

Package unit name	PUHY-HP144TSNU-A	PUHY-HP192TSNU-A	PUHY-HP240TSNU-A
Outdoor unit 1	PUHY-HP72TNU-A	PUHY-HP96TNU-A	PUHY-HP120TNU-A
Outdoor unit 2	PUHY-HP72TNU-A	PUHY-HP96TNU-A	PUHY-HP120TNU-A
Outdoor Twinning Kit(optional parts)	CMY-Y100CBK3		
BC controller	ø15.88(5/8)		
~Twinning pipe	a	ø12.7(1/2)	b
			ø28.58(1-1/8)

- Note 1. Connect the pipes as shown in the figure above. Refer to the table above for the pipe size.  
 2. Twinning pipes should not be tilted more than 15 degrees from the horizontal plane. Be sure to see the Installation Manual for details of Twinning pipe installation.  
 3. The pipe section before the Twinning pipe (section "a" and "b" in the figure) must have at least 500mm(19-11/16) of straight section (\*including the straight pipe that is supplied with the Twinning pipe).  
 4. Only use the Twinning pipe by Mitsubishi (optional parts).

PUHY-HP72, 96, 120YNU-A

Unit: mm (in.)

Note 1. Please refer to the next page for information regarding necessary spacing around the unit and foundation work.  
 2. At brazing of pipes, wrap the refrigerant service valve with wet cloth and keep the temperature of refrigerant service valve under 120°C(248°F).

Connecting pipe specifications

Model	Refrigerant pipe		Diameter	
	Liquid	Gas	Liquid	Gas
HP72	φ9.52(3/8) Brazed *1	φ22.2(7/8) Brazed *1	φ12.7(1/2)	φ28.58(1-1/8)
HP96	φ9.52(3/8) Brazed *1, *3 (φ12.7(1/2) Brazed *1, *3)			
HP120	φ9.52(3/8) Brazed *1, *2, *4 (φ12.7(1/2) Brazed *1, *2, *4)			

\*1 Connect the refrigerant pipe to the service valve according to the Installation Manual.

\*2 Indicates dimensions and connection specifications in the case the unit is used in combination with other outdoor units.

\*3 Furthest piping length (OU from IU) ≥ 90m

\*4 Furthest piping length (OU from IU) ≥ 40m

NO.	Usage	Specifications
①	For pipes	Front through hole 148(5-7/8) × 84(3-5/16) Knockout hole
②		Bottom through hole 150(5-15/16) × 84(3-3/4) Knockout hole
③		Front through hole φ62.7(2-1/2) or φ34.5(1-3/8) Knockout hole
④	For wires	Front through hole φ43.7(1-3/4) or φ22.2(7/8) Knockout hole
⑤		Bottom through hole φ65(2-9/16) Knockout hole
⑥	For transmission cables	Bottom through hole φ52(2-1/16) Knockout hole
⑦		Front through hole φ34(1-3/8) Knockout hole
⑧		Bottom through hole φ34(1-3/8) Knockout hole

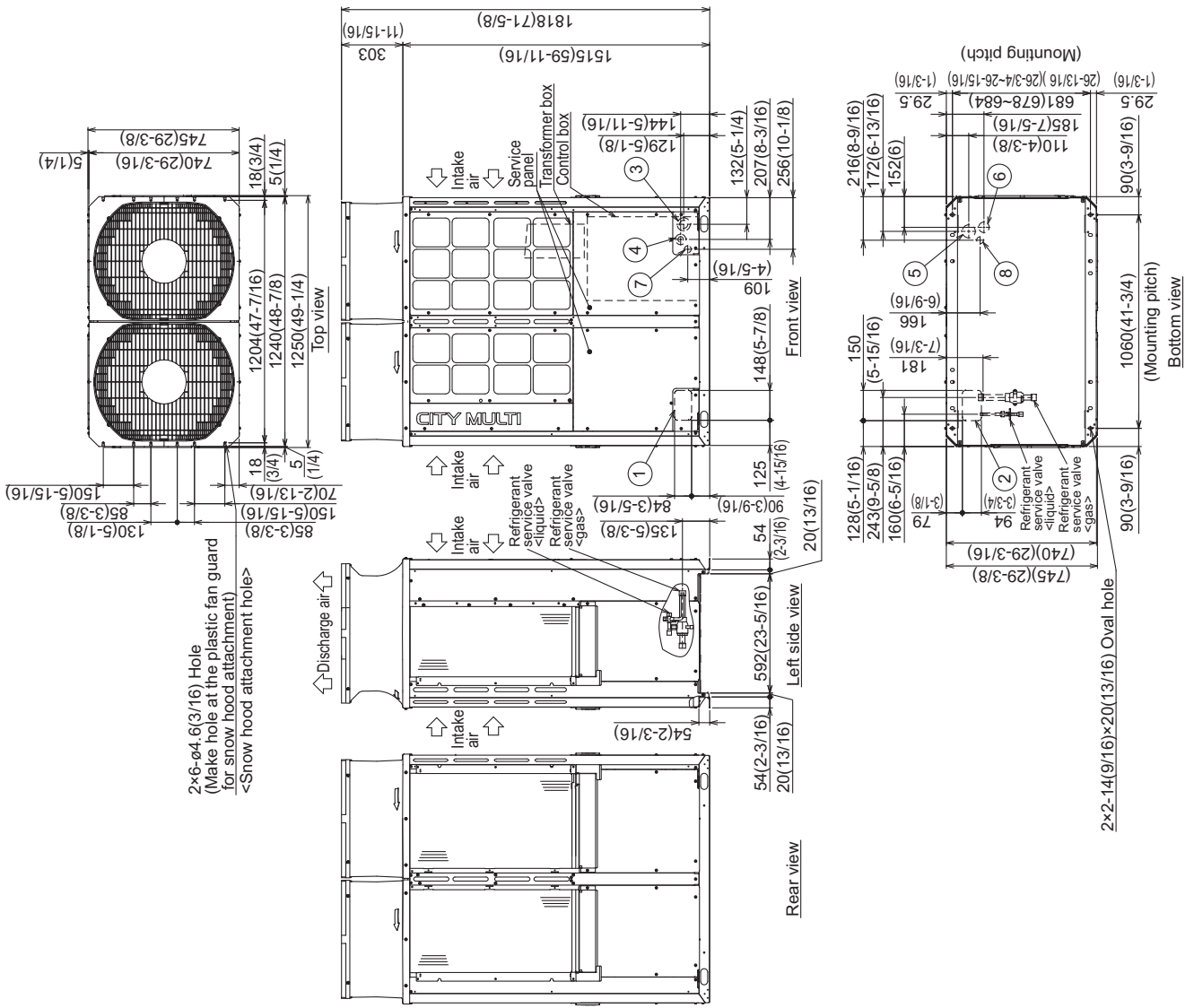

2×6-φ4.6(3/16) Hole  
 (Make hole at the plastic fan guard  
 for snow hood attachment)  
 <Snow hood attachment hole>

PUHY-HP72, 96, 120YNU-A

Unit: mm (in.)

1. Required space around the unit

● In case of single installation

① Secure enough space around the unit as shown in the figure below.

- With a space of at least 450mm(17-3/4) to the wall on the back of the unit
- With a space of at least 300mm(11-13/16) to the wall on the back of the unit

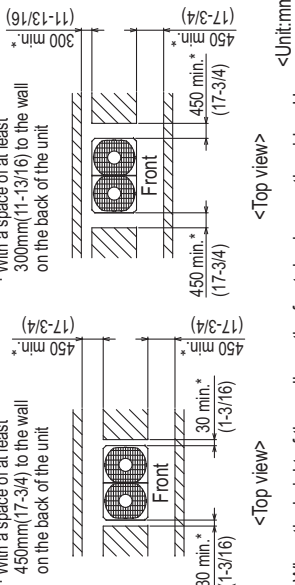

② When the height of the walls on the front, back or on the sides >H> exceeds the wall height limit as defined below add the height that exceeds the height limit <h> to the figures that are marked with an asterisk.

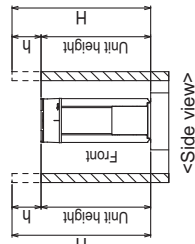

<Wall height limit> Front : Up to the unit height  
Back : Up to the unit height  
Side : Up to the unit height

2. Foundation work

- Take into consideration the surface strength, water drainage route, piping route, and wiring route when preparing the installation site.  
<Note that the drain water comes out of the unit during operation.>
- Build the foundation in such way that the corner of the installation leg is securely supported as shown in the right figure.(Fig.A)  
When using a rubber isolating cushion, please ensure it is large enough to cover the entire width of each of the unit's legs.
- The protrusion length of the anchor bolt must not exceed 30mm(1-3/16).(Fig.A)
- Use four fixing plates as shown in the right figure <field supply required> when using M12 hole-in anchor bolts <field supply required> (Fig.B)
- To prevent small animals and water and snow from entering the unit and damaging its parts, close the gap around the edges of through holes for pipes and wires with filler plates <field supply required>.
- When the pipes or cables are routed at the bottom of the unit, make sure that the through hole at the base of the unit does not get blocked with the installation base.
- Refer to the Installation Manual when installing units on an installation base.

● In case of collective installation

- When multiple units are installed adjacent to each other, secure enough space to allow for air circulation and walkway between groups of units as shown in the figures below.
- At least two sides must be left open.
- As with the single installation, add the height that exceeds the height limit <h> to the figures that are marked with an asterisk.
- If there is a wall at both the front and the rear of the unit, install up to six units consecutively in the side direction and provide a space of 1000mm(39-3/8) or more as inlet space/ passage space for each six units.

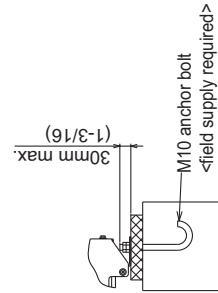
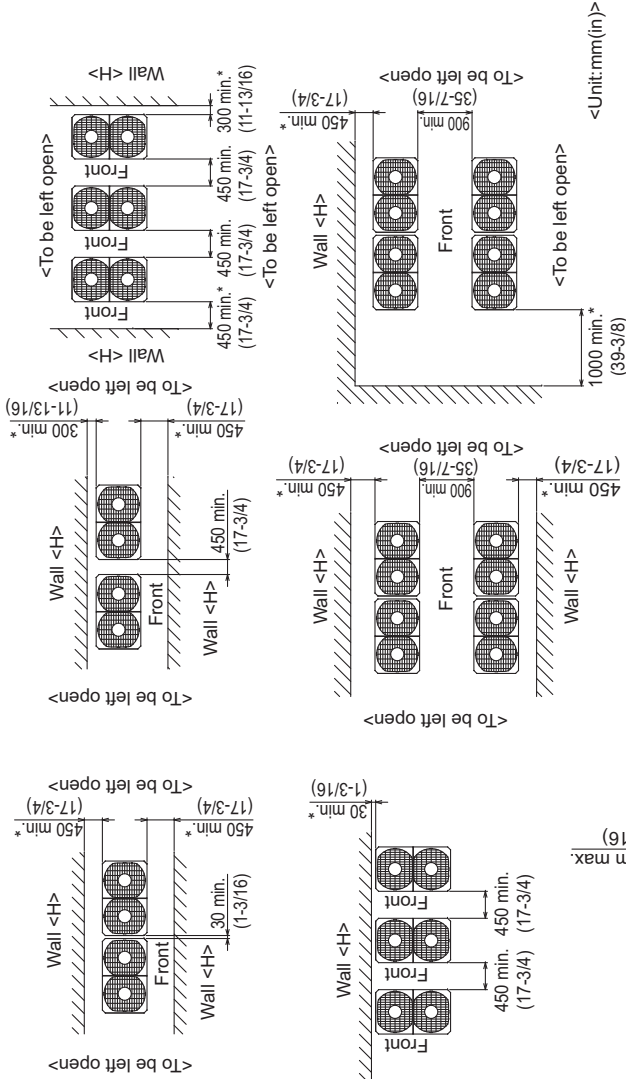

Fig.A

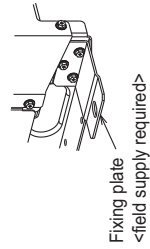
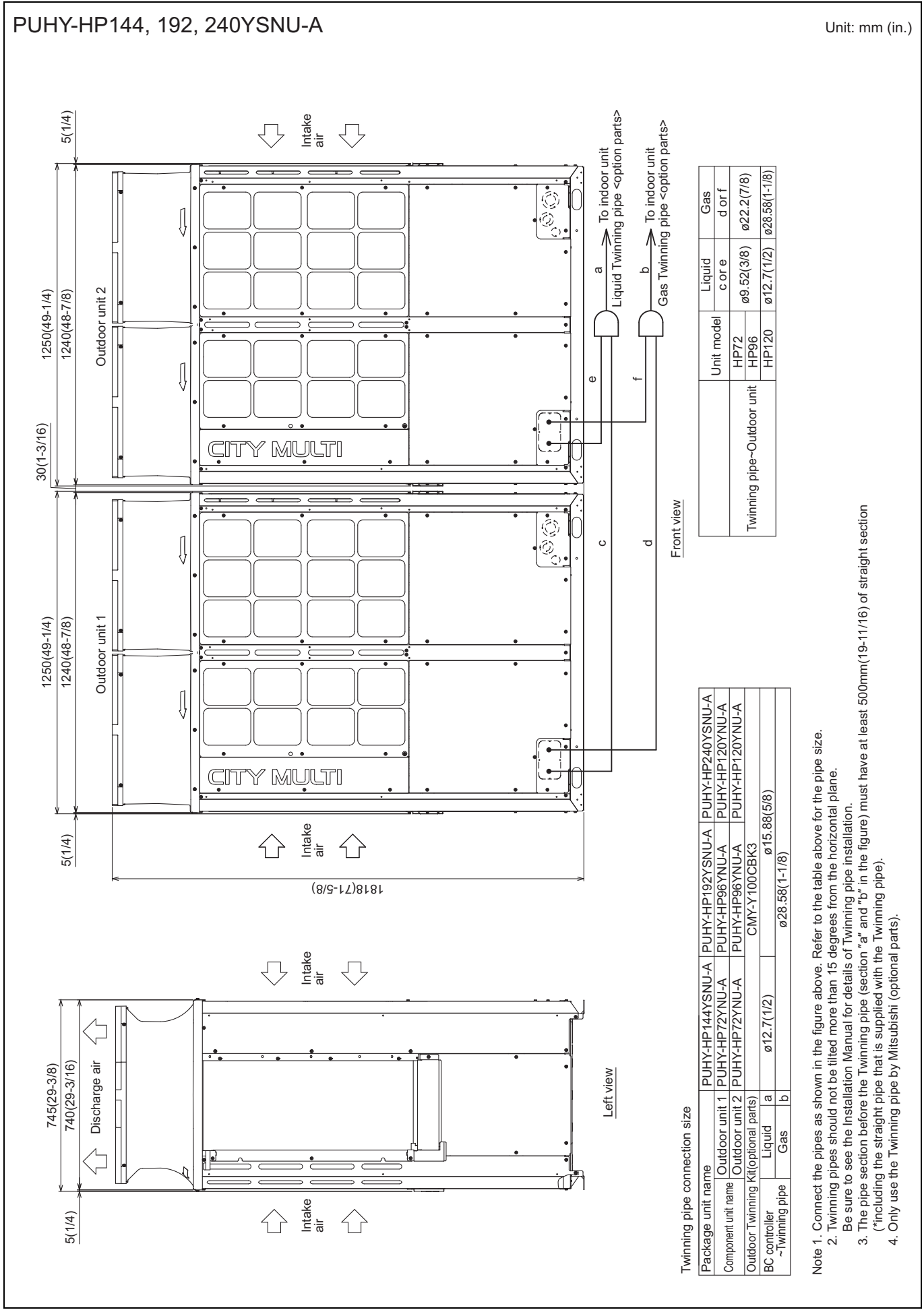
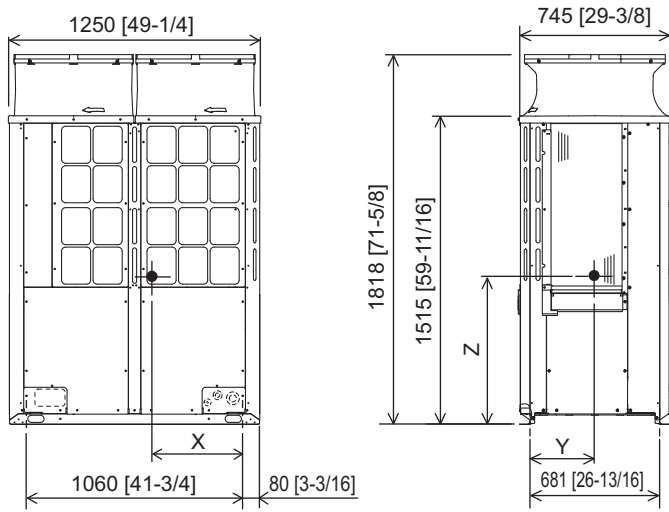

Fig.B



PUHY-HP-T(S)NU-A, Y(S)NU-A

PUHY-HP72, 96, 120TNU-A  
 PUHY-HP72, 96, 120YNU-A



Unit: mm [in.]

Model	X	Y	Z
PUHY-HP72TNU-A	495 [19-1/2]	353 [13-15/16]	698 [27-1/2]
PUHY-HP96TNU-A	497 [19-5/8]	352 [13-7/8]	718 [28-5/16]
PUHY-HP120TNU-A	497 [19-5/8]	352 [13-7/8]	718 [28-5/16]
PUHY-HP72YNU-A	477 [18-13/16]	342 [13-1/2]	695 [27-3/8]
PUHY-HP96YNU-A	480 [18-15/16]	342 [13-1/2]	715 [28-3/16]
PUHY-HP120YNU-A	480 [18-15/16]	342 [13-1/2]	715 [28-3/16]



PUHY-HP-72, 96, 120TNU-A

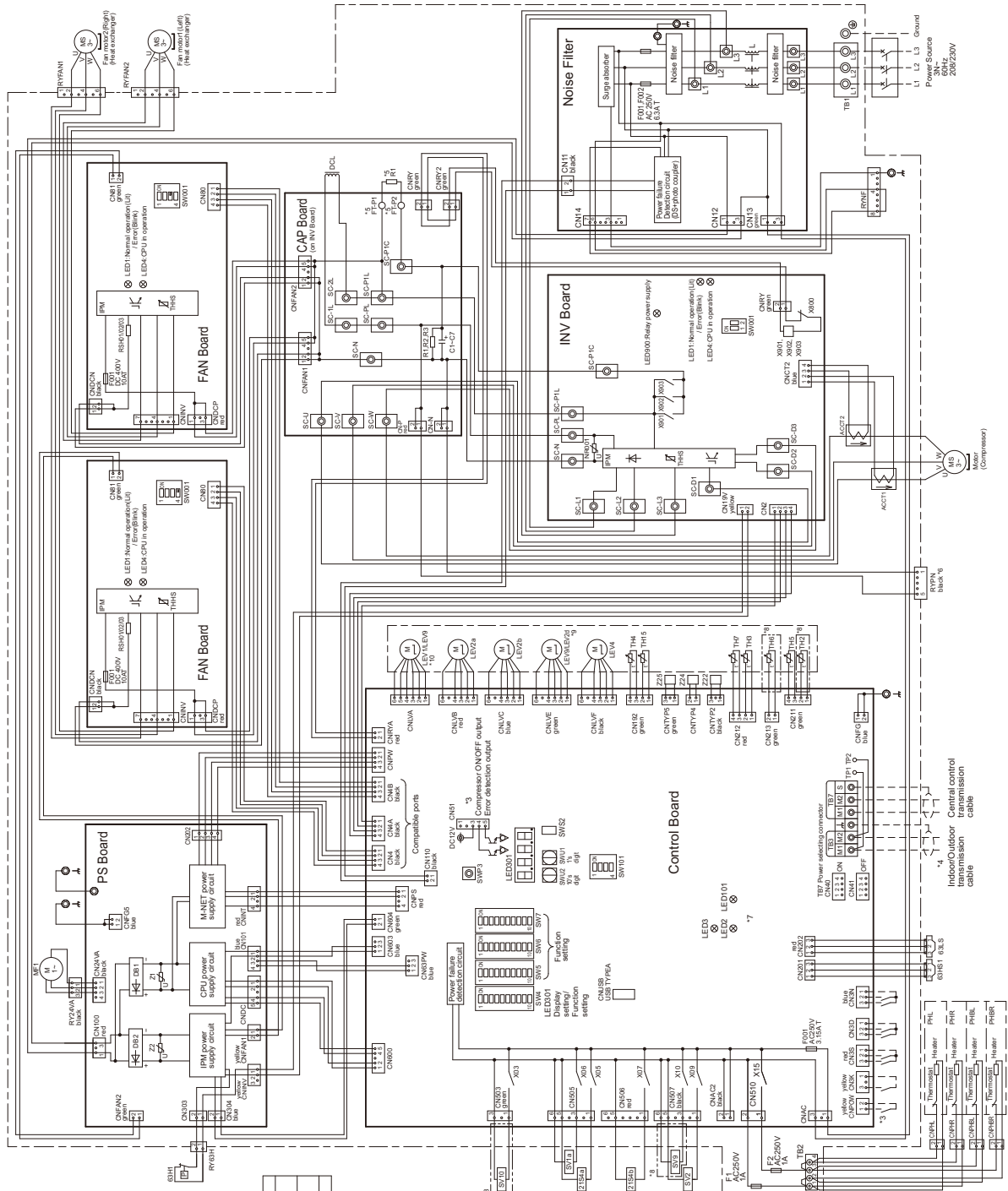

- \*1. Single-dotted lines indicate wiring not supplied with the unit.
- \*2. Dot-dash lines indicate the control box boundaries.
- \*3. Refer to the Data book for connecting input/output signal connectors.
- \*4. Daisy-chain terminals (TB3) on the outdoor units in the same refrigerant system together.
- \*5. Faston terminals have a locking function. Make sure the terminals are securely locked in place after insertion. Press the tab on the terminals to removed them.
- \*6. Control box houses high-voltage parts. Before inspecting the inside of the control box, turn off the power, keep the unit off for at least 10 minutes, and confirm that the voltage of the connector RYPN has dropped to DC20V or less.
- \*7. Control board LED display.
  - LED2: Normal operation(LED/Blk)
  - LED3: SW6-10 is OFF and In operation(LED/In stop(Uni))
  - SW4-10 are ON
  - SW6-10 is ON
- \*8. Difference of appliance.
 

Model name	Appliance
PUHY/TUHY	'8 exist
PURY/TURY	'8 do not exist
- \*9. Difference of appliance.
 

Model name	Appliance
PUHY/TUHY	LEV9
PURY/TURY	LEV24
- \*10. Difference of appliance.
 

Model name	Appliance
PUHY/TUHY	LEV1
PURY/TURY	LEV9

Symbol	Explanation
2154a	4-way valve
2154b	Cooling/Heating switching
2154c	Heat exchanger capacity controlonly (PUHY model)
2154d	Cooling/Heating switching
63H1	High pressure protection for the outdoor unit
63H2	Pressure switch
63H3	Discharge pressure
ACCT1/ACCT2	Low pressure
C1-C7	Capacitor (inverter main circuit)
DCL	DC reactor
L	Choke coil (for high frequency noise reduction)
LEV1~10	Linear expansion valve
LEV2a,b	HIC bypass,noise refrigerant flow in HIC circuit
LEV2c	Pressure control,Refrigerant flow rate control
LEV4	Pressure control,Refrigerant flow rate control
LEV9~9,10	For opening/closing the injection circuit
PH1,PH2,PH3	Heat exchanger for inverter
PH4,PH5,PH6	Fan motor(for cooling in control box)
PH7,PH8,PH9	Panel heater
PH10	Resistor
ESR1010203	For rough current prevention
SV1a	For current detection
SV1b	For opening/closing the bypass circuit under the O/S
SV2	For opening/closing the discharge suction bypass
SV9~8	For opening/closing the bypass circuit
SV10~8	For continuous heating
TB1	Power supply
TB2	Heater transmission line
TB3	Indoor/Outdoor transmission line
TB7	Central control transmission line
TH2~8	Subcool temperature
TH3	Compressor shell temperature
TH4	Compressor shell bottom temperature
TH5	Compressor shell top temperature
TH6~9	Subcooled liquid refrigerant temperature
TH7	O/A temperature
TH8	Compressor shell bottom temperature
TH9	Compressor shell top temperature
TH10	Compressor shell bottom temperature
TH11	Compressor shell top temperature
TH12	Compressor shell bottom temperature
TH13	Compressor shell top temperature
TH14	Compressor shell bottom temperature
TH15	Compressor shell top temperature
TH16	Compressor shell bottom temperature
TH17	Compressor shell top temperature
TH18	Compressor shell bottom temperature
TH19	Compressor shell top temperature
TH20	Compressor shell bottom temperature
TH21	Compressor shell top temperature
TH22	Compressor shell bottom temperature
TH23	Compressor shell top temperature
TH24	Compressor shell bottom temperature
TH25	Compressor shell top temperature
TH26	Compressor shell bottom temperature
TH27	Compressor shell top temperature
TH28	Compressor shell bottom temperature
TH29	Compressor shell top temperature
TH30	Compressor shell bottom temperature
TH31	Compressor shell top temperature
TH32	Compressor shell bottom temperature
TH33	Compressor shell top temperature
TH34	Compressor shell bottom temperature
TH35	Compressor shell top temperature
TH36	Compressor shell bottom temperature
TH37	Compressor shell top temperature
TH38	Compressor shell bottom temperature
TH39	Compressor shell top temperature
TH40	Compressor shell bottom temperature
TH41	Compressor shell top temperature
TH42	Compressor shell bottom temperature
TH43	Compressor shell top temperature
TH44	Compressor shell bottom temperature
TH45	Compressor shell top temperature
TH46	Compressor shell bottom temperature
TH47	Compressor shell top temperature
TH48	Compressor shell bottom temperature
TH49	Compressor shell top temperature
TH50	Compressor shell bottom temperature
TH51	Compressor shell top temperature
TH52	Compressor shell bottom temperature
TH53	Compressor shell top temperature
TH54	Compressor shell bottom temperature
TH55	Compressor shell top temperature
TH56	Compressor shell bottom temperature
TH57	Compressor shell top temperature
TH58	Compressor shell bottom temperature
TH59	Compressor shell top temperature
TH60	Compressor shell bottom temperature
TH61	Compressor shell top temperature
TH62	Compressor shell bottom temperature
TH63	Compressor shell top temperature
TH64	Compressor shell bottom temperature
TH65	Compressor shell top temperature
TH66	Compressor shell bottom temperature
TH67	Compressor shell top temperature
TH68	Compressor shell bottom temperature
TH69	Compressor shell top temperature
TH70	Compressor shell bottom temperature
TH71	Compressor shell top temperature
TH72	Compressor shell bottom temperature
TH73	Compressor shell top temperature
TH74	Compressor shell bottom temperature
TH75	Compressor shell top temperature
TH76	Compressor shell bottom temperature
TH77	Compressor shell top temperature
TH78	Compressor shell bottom temperature
TH79	Compressor shell top temperature
TH80	Compressor shell bottom temperature
TH81	Compressor shell top temperature
TH82	Compressor shell bottom temperature
TH83	Compressor shell top temperature
TH84	Compressor shell bottom temperature
TH85	Compressor shell top temperature
TH86	Compressor shell bottom temperature
TH87	Compressor shell top temperature
TH88	Compressor shell bottom temperature
TH89	Compressor shell top temperature
TH90	Compressor shell bottom temperature
TH91	Compressor shell top temperature
TH92	Compressor shell bottom temperature
TH93	Compressor shell top temperature
TH94	Compressor shell bottom temperature
TH95	Compressor shell top temperature
TH96	Compressor shell bottom temperature
TH97	Compressor shell top temperature
TH98	Compressor shell bottom temperature
TH99	Compressor shell top temperature
TH100	Compressor shell bottom temperature

<Symbol explanation>

Symbol	Explanation
2154a	4-way valve
2154b	Cooling/Heating switching
2154c	Heat exchanger capacity controlonly (PUHY model)
2154d	Cooling/Heating switching
63H1	High pressure protection for the outdoor unit
63H2	Pressure switch
63H3	Discharge pressure
ACCT1/ACCT2	Low pressure
C1-C7	Capacitor (inverter main circuit)
DCL	DC reactor
L	Choke coil (for high frequency noise reduction)
LEV1~10	Linear expansion valve
LEV2a,b	HIC bypass,noise refrigerant flow in HIC circuit
LEV2c	Pressure control,Refrigerant flow rate control
LEV4	Pressure control,Refrigerant flow rate control
LEV9~9,10	For opening/closing the injection circuit
PH1,PH2,PH3	Heat exchanger for inverter
PH4,PH5,PH6	Fan motor(for cooling in control box)
PH7,PH8,PH9	Panel heater
PH10	Resistor
ESR1010203	For rough current prevention
SV1a	For current detection
SV1b	For opening/closing the bypass circuit under the O/S
SV2	For opening/closing the discharge suction bypass
SV9~8	For opening/closing the bypass circuit
SV10~8	For continuous heating
TB1	Power supply
TB2	Heater transmission line
TB3	Indoor/Outdoor transmission line
TB7	Central control transmission line
TH2~8	Subcool temperature
TH3	Compressor shell temperature
TH4	Compressor shell bottom temperature
TH5	Compressor shell top temperature
TH6~9	Subcooled liquid refrigerant temperature
TH7	O/A temperature
TH8	Compressor shell bottom temperature
TH9	Compressor shell top temperature
TH10	Compressor shell bottom temperature
TH11	Compressor shell top temperature
TH12	Compressor shell bottom temperature
TH13	Compressor shell top temperature
TH14	Compressor shell bottom temperature
TH15	Compressor shell top temperature
TH16	Compressor shell bottom temperature
TH17	Compressor shell top temperature
TH18	Compressor shell bottom temperature
TH19	Compressor shell top temperature
TH20	Compressor shell bottom temperature
TH21	Compressor shell top temperature
TH22	Compressor shell bottom temperature
TH23	Compressor shell top temperature
TH24	Compressor shell bottom temperature
TH25	Compressor shell top temperature
TH26	Compressor shell bottom temperature
TH27	Compressor shell top temperature
TH28	Compressor shell bottom temperature
TH29	Compressor shell top temperature
TH30	Compressor shell bottom temperature
TH31	Compressor shell top temperature
TH32	Compressor shell bottom temperature
TH33	Compressor shell top temperature
TH34	Compressor shell bottom temperature
TH35	Compressor shell top temperature
TH36	Compressor shell bottom temperature
TH37	Compressor shell top temperature
TH38	Compressor shell bottom temperature
TH39	Compressor shell top temperature
TH40	Compressor shell bottom temperature
TH41	Compressor shell top temperature
TH42	Compressor shell bottom temperature
TH43	Compressor shell top temperature
TH44	Compressor shell bottom temperature
TH45	Compressor shell top temperature
TH46	Compressor shell bottom temperature
TH47	Compressor shell top temperature
TH48	Compressor shell bottom temperature
TH49	Compressor shell top temperature
TH50	Compressor shell bottom temperature
TH51	Compressor shell top temperature
TH52	Compressor shell bottom temperature
TH53	Compressor shell top temperature
TH54	Compressor shell bottom temperature
TH55	Compressor shell top temperature
TH56	Compressor shell bottom temperature
TH57	Compressor shell top temperature
TH58	Compressor shell bottom temperature
TH59	Compressor shell top temperature
TH60	Compressor shell bottom temperature
TH61	Compressor shell top temperature
TH62	Compressor shell bottom temperature
TH63	Compressor shell top temperature
TH64	Compressor shell bottom temperature
TH65	Compressor shell top temperature
TH66	Compressor shell bottom temperature
TH67	Compressor shell top temperature
TH68	Compressor shell bottom temperature
TH69	Compressor shell top temperature
TH70	Compressor shell bottom temperature
TH71	Compressor shell top temperature
TH72	Compressor shell bottom temperature
TH73	Compressor shell top temperature
TH74	Compressor shell bottom temperature
TH75	Compressor shell top temperature
TH76	Compressor shell bottom temperature
TH77	Compressor shell top temperature
TH78	Compressor shell bottom temperature
TH79	Compressor shell top temperature
TH80	Compressor shell bottom temperature
TH81	Compressor shell top temperature
TH82	Compressor shell bottom temperature
TH83	Compressor shell top temperature
TH84	Compressor shell bottom temperature
TH85	Compressor shell top temperature
TH86	Compressor shell bottom temperature
TH87	Compressor shell top temperature
TH88	Compressor shell bottom temperature
TH89	Compressor shell top temperature
TH90	Compressor shell bottom temperature
TH91	Compressor shell top temperature
TH92	Compressor shell bottom temperature
TH93	Compressor shell top temperature
TH94	Compressor shell bottom temperature
TH95	Compressor shell top temperature
TH96	Compressor shell bottom temperature
TH97	Compressor shell top temperature
TH98	Compressor shell bottom temperature
TH99	Compressor shell top temperature
TH100	Compressor shell bottom temperature

PUHY-HP72, 96, 120YNU-A

PUHY-HP-T(S)NU-A, Y(S)NU-A

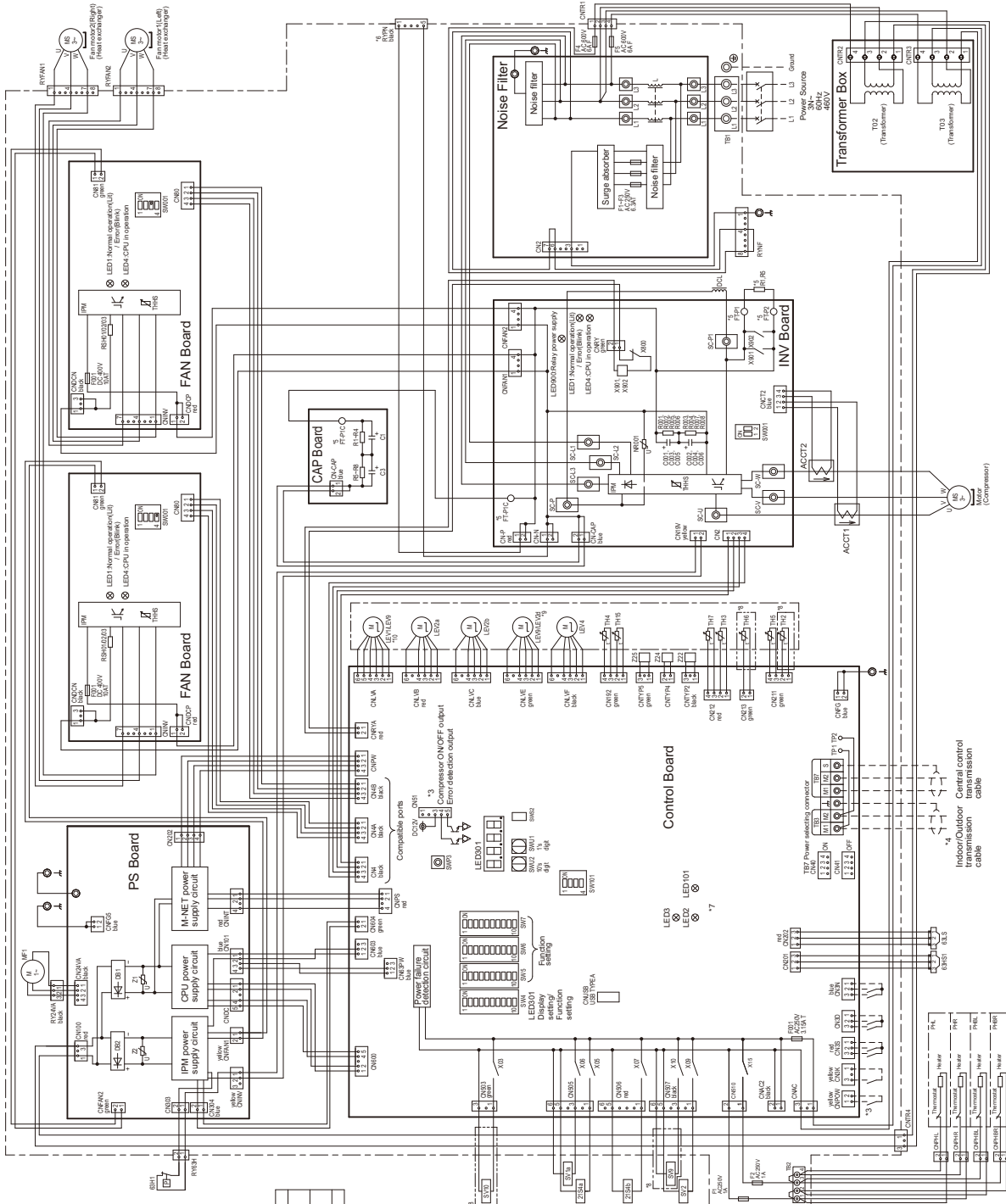

- \*1. Single-dotted lines indicate wiring not supplied with the unit.
- \*2. Dot-dash lines indicate the control box boundaries.
- \*3. Refer to the Data book for connecting input/output signal connectors.
- \*4. Daisy-chain terminals (TB3) on the outdoor units in the same refrigerant system together.
- \*5. Faston terminals have a locking function. Make sure the terminals are securely locked in place after insertion. Press the tab on the terminals to removed them.
- \*6. Control box houses high-voltage parts. Before inspecting the inside of the control box turn off the power-keep the unit off for at least 10 minutes, and confirm that the voltage of the connector RYPN has dropped to DC20V or less.
- \*7. Control board LED display.

LED2	Normal operation(LED/Error/Blank)
LED3	SW6-10 is OFF and In operation(LED/In stop/Unit)
SW4-1-10	Function setting by SW4
SW6-1-10	Function setting by SW6
LED101	Normal operation(LED/Err/Unit)

\*10. Difference of appliance.

Model name	Appliance
PUHY/TURY	'8 axis
PURY/TURY	'9, do not exist

\*9. Difference of appliance.

Model name	Appliance
PUHY/TURY	LEV9
PURY/TURY	LEV2d

<Symbol explanation>

Symbol	Explanation
Z1S4a	4-way valve
Z1S4b	Cooling/Heating switching
69H1	Heat exchanger capacity control (only PUHY model)
69H1	Cooling/Heating switching
69H1	High pressure protection for the outdoor unit
69H1	Discharge pressure
ACCT1	Low pressure
C1, C3	Current sensor(A/C)
C001-C006	Capacitor (inverter main circuit)
DCL	DC reactor
L	Choke coil (for high frequency noise reduction)
LEV1 *10	HIC bypass Controls refrigerant flow in HIC circuit
LEV2a,b	Pressure control/Refrigerant flow rate control
LEV2d *9	Pressure control/Refrigerant flow rate control
LEV4	For opening/closing the injection circuit
HP/HL/BR	Heat exchanger for inverter
FM/FL/BL	Fan motor(for cooling in control box)
RS901/92/93	Resistor
SV1a	For flush current prevention
SV2	For opening/closing the bypass circuit under the O/S
SV9 *8	For opening/closing the discharge suction bypass
SV10 *8	For opening/closing the bypass circuit
TB1	Power supply
TB2	Heater transmission line
TB3	Indoor/Outdoor transmission line
TH2 *8	Central control transmission line
TH3	Subcool bypass outlet temperature
TH4	Pipe temperature
TH5	Discharge pipe temperature
TH7 *8	ACC inlet pipe temperature
TH7	Subcooled liquid refrigerant temperature
TH8	Compressor shell bottom temperature
TH9	IPM temperature
X901, X902	Magnetic relay(inverter main circuit)
Z22,24,25	Function setting connector



5-1. Sound levels in cooling mode

Sound level of PUHY-HP72T(Y)NU

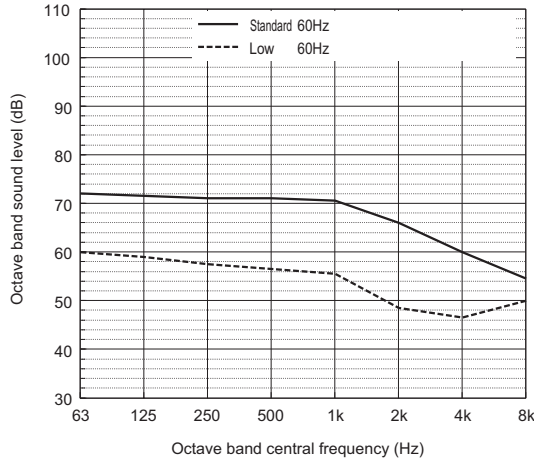

		63	125	250	500	1k	2k	4k	8k	dB(A)
Standard Cooling	60Hz	72.0	71.5	71.0	71.0	70.5	66.0	60.0	54.5	74.0
Low noise mode	60Hz	60.0	59.0	57.5	56.5	55.5	48.5	46.5	50.0	59.5

When Low noise mode is set, the A/C system's capacity is limited. The system could return to normal operation from Low noise mode automatically in the case that the operation condition is severe.

Sound level of PUHY-HP96T(Y)NU

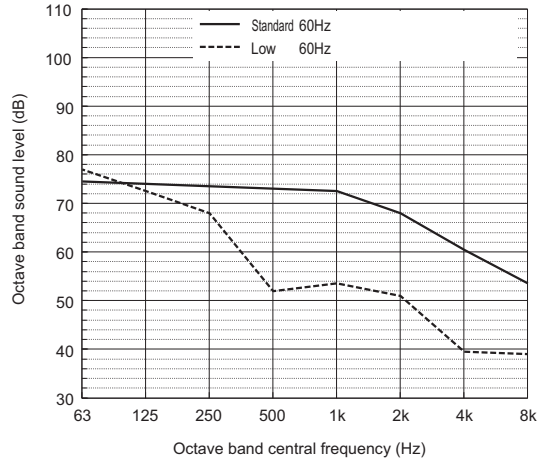

		63	125	250	500	1k	2k	4k	8k	dB(A)
Standard Cooling	60Hz	74.5	74.0	73.5	73.0	72.5	68.0	60.5	53.5	76.0
Low noise mode	60Hz	77.0	72.5	68.0	52.0	53.5	51.0	39.5	39.0	63.0

When Low noise mode is set, the A/C system's capacity is limited. The system could return to normal operation from Low noise mode automatically in the case that the operation condition is severe.

Sound level of PUHY-HP120T(Y)NU

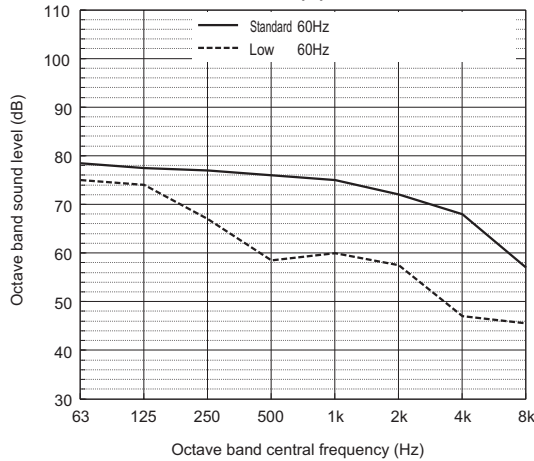

		63	125	250	500	1k	2k	4k	8k	dB(A)
Standard Cooling	60Hz	78.5	77.5	77.0	76.0	75.0	72.0	68.0	57.0	79.5
Low noise mode	60Hz	75.0	74.0	67.0	58.5	60.0	57.5	47.0	45.5	65.5

When Low noise mode is set, the A/C system's capacity is limited. The system could return to normal operation from Low noise mode automatically in the case that the operation condition is severe.

Sound level of PUHY-HP144T(Y)SNU

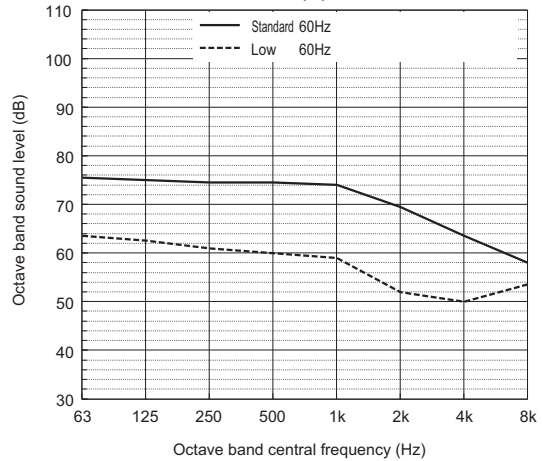

		63	125	250	500	1k	2k	4k	8k	dB(A)
Standard Cooling	60Hz	75.5	75.0	74.5	74.5	74.0	69.5	63.5	58.0	77.5
Low noise mode	60Hz	63.5	62.5	61.0	60.0	59.0	52.0	50.0	53.5	63.0

When Low noise mode is set, the A/C system's capacity is limited. The system could return to normal operation from Low noise mode automatically in the case that the operation condition is severe.

Sound level of PUHY-HP192T(Y)SNU

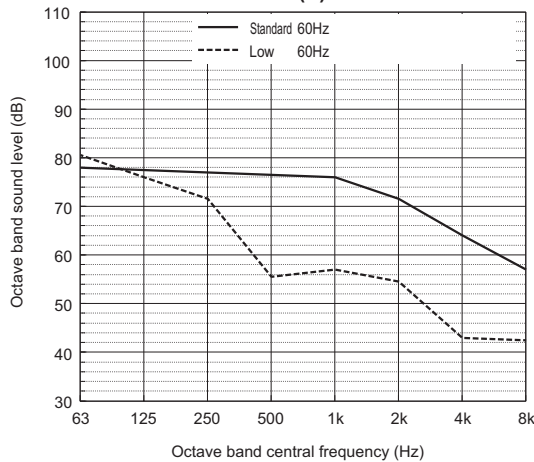

		63	125	250	500	1k	2k	4k	8k	dB(A)
Standard Cooling	60Hz	78.0	77.5	77.0	76.5	76.0	71.5	64.0	57.0	79.5
Low noise mode	60Hz	80.5	76.0	71.5	55.5	57.0	54.5	43.0	42.5	66.5

When Low noise mode is set, the A/C system's capacity is limited. The system could return to normal operation from Low noise mode automatically in the case that the operation condition is severe.

Sound level of PUHY-HP240T(Y)SNU

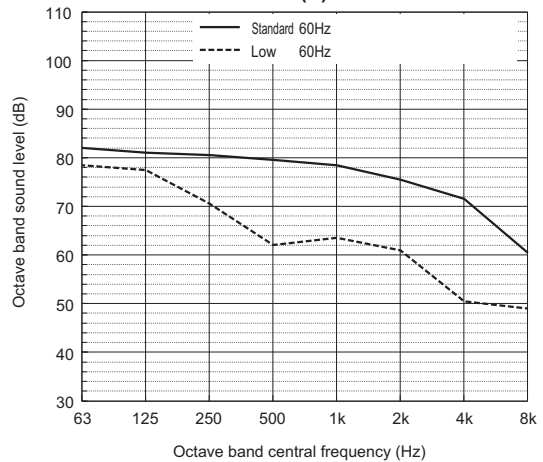

		63	125	250	500	1k	2k	4k	8k	dB(A)
Standard Cooling	60Hz	82.0	81.0	80.5	79.5	78.5	75.5	71.5	60.5	83.0
Low noise mode	60Hz	78.5	77.5	70.5	62.0	63.5	61.0	50.5	49.0	69.0

When Low noise mode is set, the A/C system's capacity is limited. The system could return to normal operation from Low noise mode automatically in the case that the operation condition is severe.

- Depending on the operation conditions, the unit generates noise caused by valve actuation, refrigerant flow, and pressure changes when operating normally. Please consider to avoid location where quietness is required.
- The sound values are sound power level (PWL) based on ISO 3744:2010 (r = 3.5 m).

5-2. Sound levels in heating mode

PUHY-HP-T(S)NU-A, Y(S)NU-A

Sound level of PUHY-HP72T(Y)NU

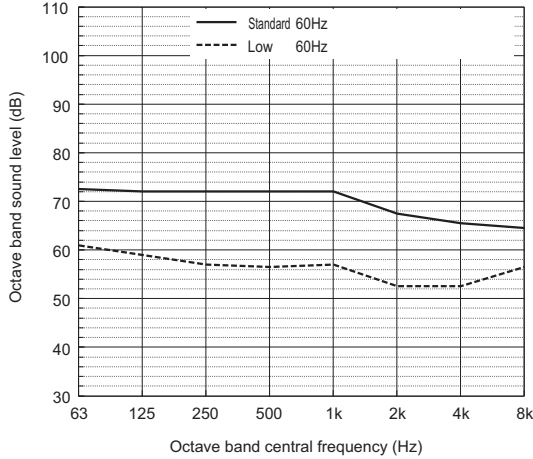

		63	125	250	500	1k	2k	4k	8k	dB(A)
Standard Heating	60Hz	72.5	72.0	72.0	72.0	72.0	67.5	65.5	64.5	76.0
Low noise mode	60Hz	61.0	59.0	57.0	56.5	57.0	52.5	52.5	56.5	62.0

When Low noise mode is set, the A/C system's capacity is limited. The system could return to normal operation from Low noise mode automatically in the case that the operation condition is severe.

Sound level of PUHY-HP96T(Y)NU

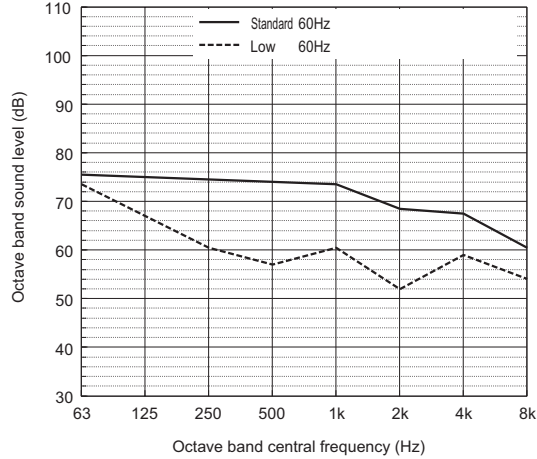

		63	125	250	500	1k	2k	4k	8k	dB(A)
Standard Heating	60Hz	75.5	75.0	74.5	74.0	73.5	68.5	67.5	60.5	77.5
Low noise mode	60Hz	73.5	67.0	60.5	57.0	60.5	52.0	59.0	54.0	65.0

When Low noise mode is set, the A/C system's capacity is limited. The system could return to normal operation from Low noise mode automatically in the case that the operation condition is severe.

Sound level of PUHY-HP120T(Y)NU

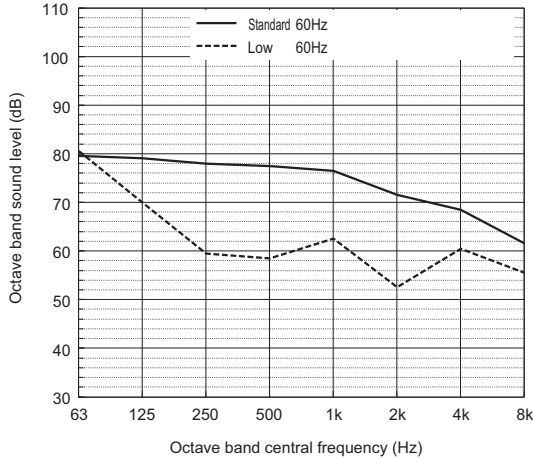

		63	125	250	500	1k	2k	4k	8k	dB(A)
Standard Heating	60Hz	79.5	79.0	78.0	77.5	76.5	71.5	68.5	61.5	80.5
Low noise mode	60Hz	80.5	70.0	59.5	58.5	62.5	52.5	60.5	55.5	66.5

When Low noise mode is set, the A/C system's capacity is limited. The system could return to normal operation from Low noise mode automatically in the case that the operation condition is severe.

Sound level of PUHY-HP144T(Y)SNU

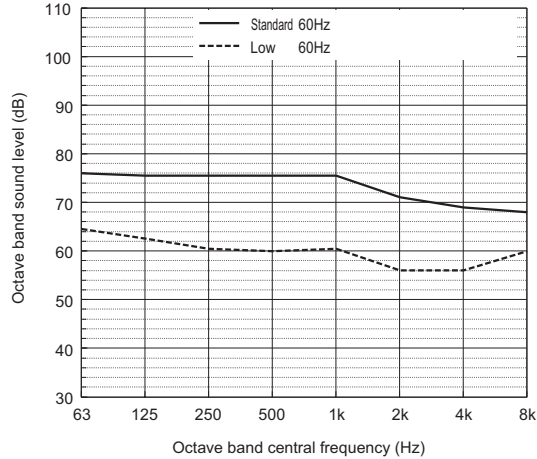

		63	125	250	500	1k	2k	4k	8k	dB(A)
Standard Heating	60Hz	76.0	75.5	75.5	75.5	75.5	71.0	69.0	68.0	79.5
Low noise mode	60Hz	64.5	62.5	60.5	60.0	60.5	56.0	56.0	60.0	65.5

When Low noise mode is set, the A/C system's capacity is limited. The system could return to normal operation from Low noise mode automatically in the case that the operation condition is severe.

Sound level of PUHY-HP192T(Y)SNU

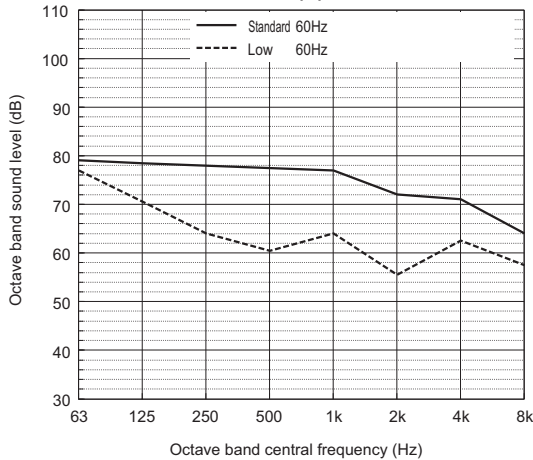

		63	125	250	500	1k	2k	4k	8k	dB(A)
Standard Heating	60Hz	79.0	78.5	78.0	77.5	77.0	72.0	71.0	64.0	81.0
Low noise mode	60Hz	77.0	70.5	64.0	60.5	64.0	55.5	62.5	57.5	68.5

When Low noise mode is set, the A/C system's capacity is limited. The system could return to normal operation from Low noise mode automatically in the case that the operation condition is severe.

Sound level of PUHY-HP240T(Y)SNU

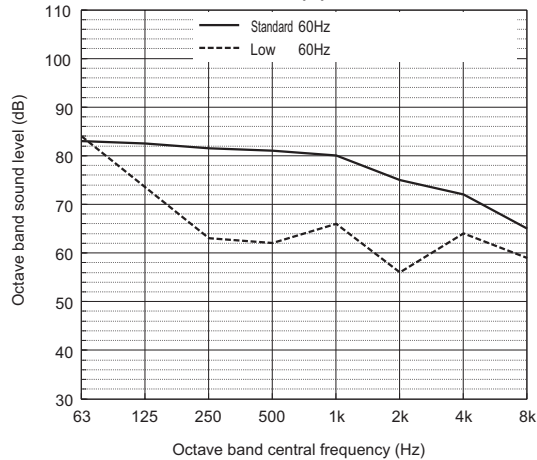

		63	125	250	500	1k	2k	4k	8k	dB(A)
Standard Heating	60Hz	83.0	82.5	81.5	81.0	80.0	75.0	72.0	65.0	84.0
Low noise mode	60Hz	84.0	73.5	63.0	62.0	66.0	56.0	64.0	59.0	70.0

When Low noise mode is set, the A/C system's capacity is limited. The system could return to normal operation from Low noise mode automatically in the case that the operation condition is severe.

- Depending on the operation conditions, the unit generates noise caused by valve actuation, refrigerant flow, and pressure changes when operating normally. Please consider to avoid location where quietness is required.
- The sound values are sound power level (PWL) based on ISO 3744:2010 (r = 3.5 m).

**[PUHY-HP72-120T/YNU, PUHY-HP144-240T/YSNU]**

Measurement condition

Measurement frequency: 1 Hz-80 Hz

Measurement point: Ground surface 20 cm away from the unit leg

Installation condition: Direct installation on the concrete floor

Power source: 3-phase 3-wire 208 V-230 V 60 Hz: For TNU-Series

3-phase 3-wire 460 V 60 Hz: For YNU-Series

Operation condition: JIS condition (cooling, heating)

Measurement device: Vibration level meter for vibration pollution VM-1220C (JIS-compliant product)

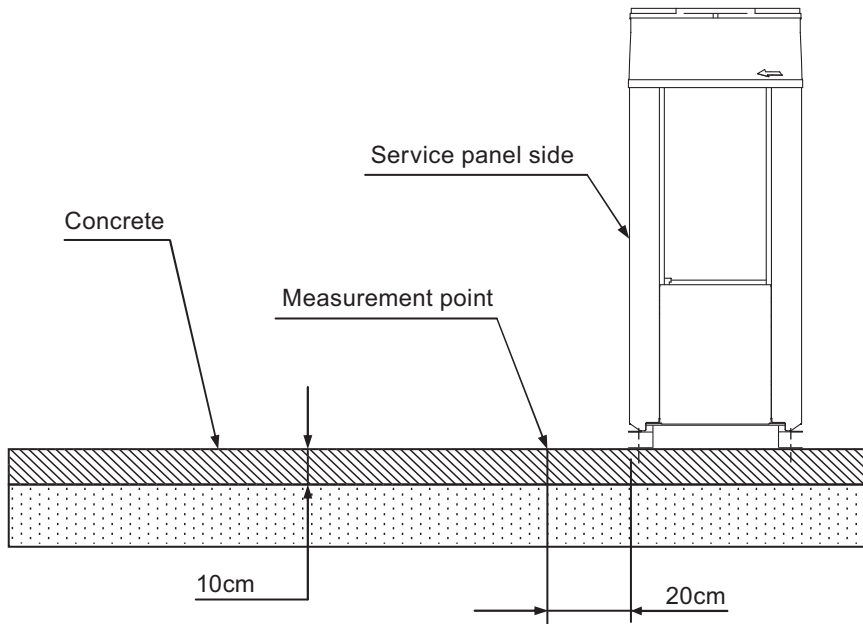

Vibration level

Model	Vibration level (dB)
PUHY-HP72T(Y)NU-A	46
PUHY-HP96T(Y)NU-A	46
PUHY-HP120T(Y)NU-A	47
PUHY-HP144T(Y)SNU-A	49
PUHY-HP192T(Y)SNU-A	49
PUHY-HP240T(Y)SNU-A	50

\* Vibration level varies depending on the conditions of actual installation site.

PUHY-HP-T(S)NU-A, Y(S)NU-A

• Cooling

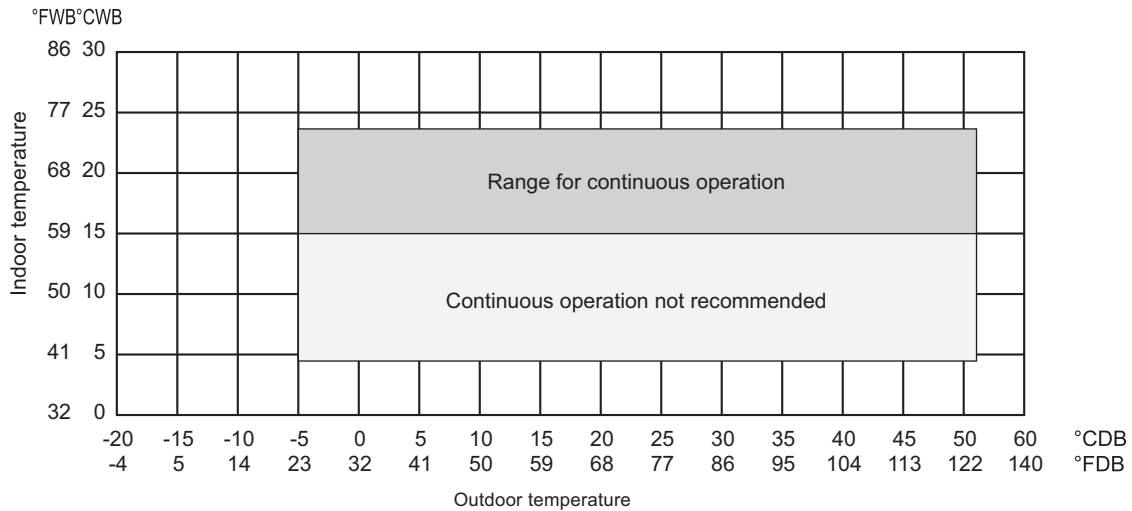

\* The operation temperature of outdoor unit is limited into 0~43°CDB(32~109°FDB) when the outdoor unit is installed in a location that is positioned lower than the indoor units.

• Heating

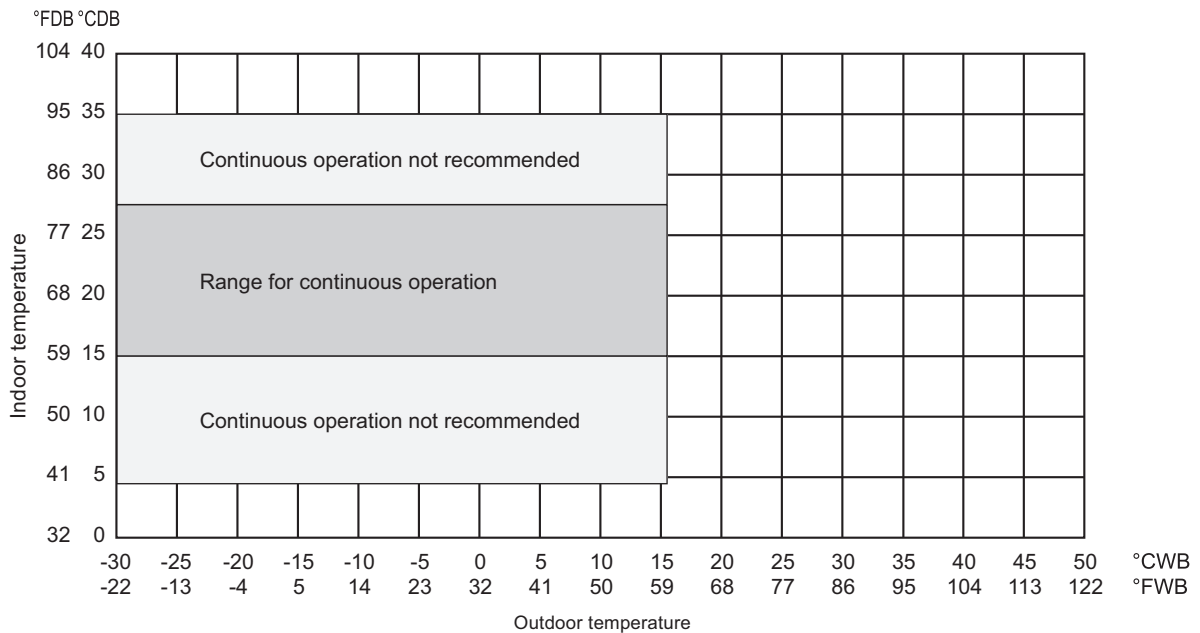

Installation of the low ambient kit is recommended to operate in cooling mode in conditions under 50°F [10°C].

Section 8-1.

Shows an example of how to select the indoor and outdoor units according to the required heating/cooling load.

Section 8-2. through 8-6.

Show the actual correction data of indoor and outdoor units.

8-1. Selection of Cooling/Heating Units

How to determine the capacity when less than or equal 100% indoor model size units are connected in total:

The purpose of this flow chart is to select the indoor and outdoor units. For other purposes, this flow chart is intended only for reference.

PUHY-HP-T(S)NU-A, Y(S)NU-A

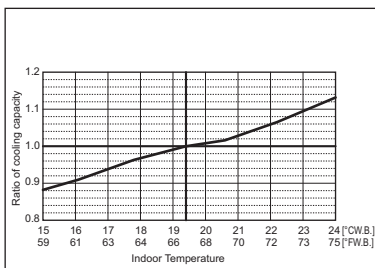
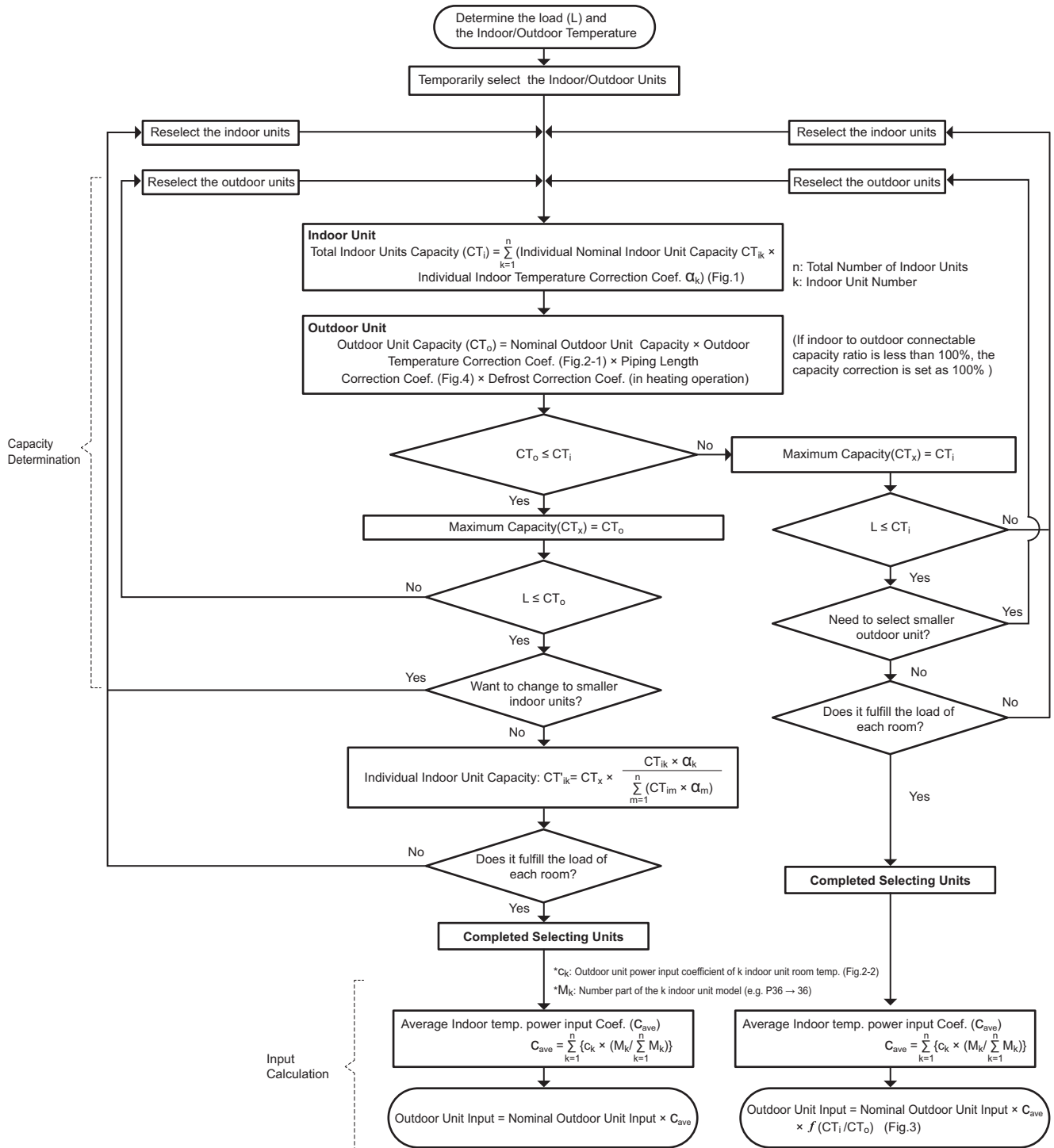

Fig.1 Indoor unit temperature correction

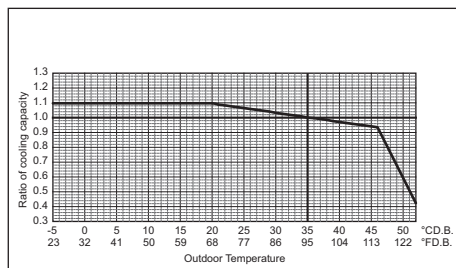

Fig.2-1 Outdoor unit temperature correction (capacity)

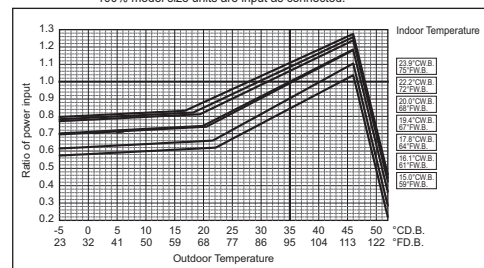
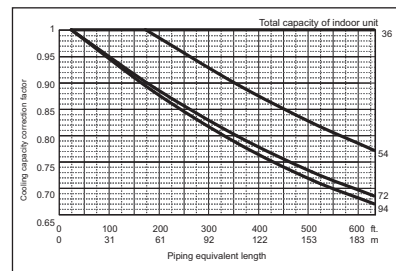
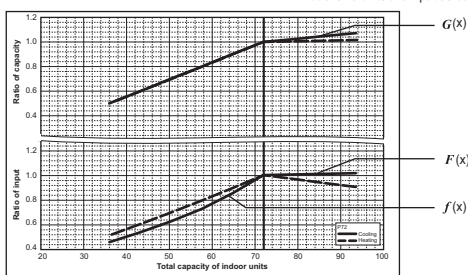
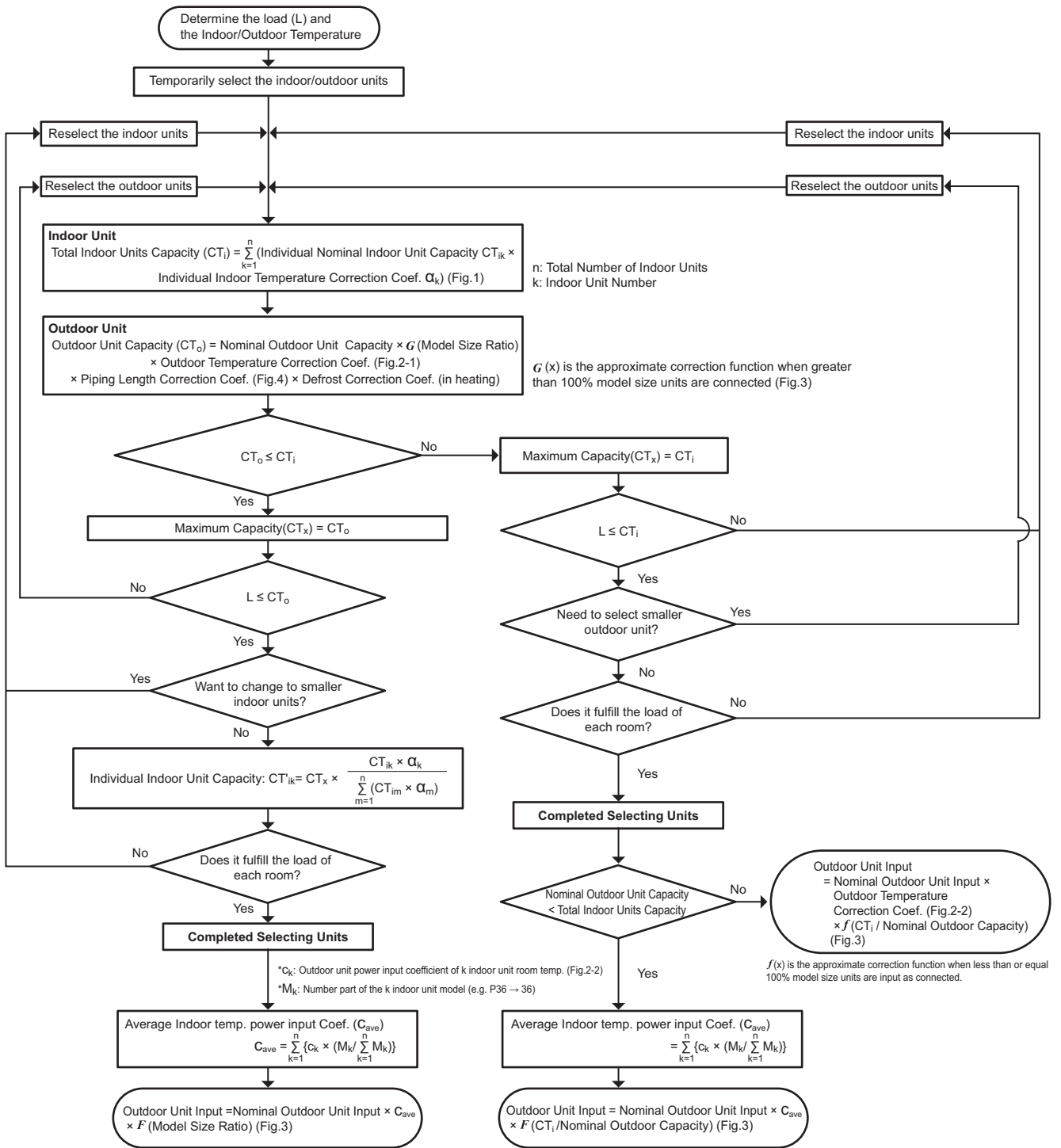

Fig.2-2 Outdoor unit temperature correction (power input)

**How to determine the capacity when greater than 100% indoor model size units are connected in total:**

The purpose of this flow chart is to select the indoor and outdoor units. For other purposes, this flow chart is intended only for reference.





<Cooling>

Design Condition	
Outdoor Design Dry Bulb Temperature	37 °C
Total Cooling Load	18.5 kW
Room1	
Indoor Design Dry Bulb Temperature	27 °C
Indoor Design Wet Bulb Temperature	20 °C
Cooling Load	9.0 kW
Room2	
Indoor Design Dry Bulb Temperature	24 °C
Indoor Design Wet Bulb Temperature	17.8 °C
Cooling Load	9.5 kW
<Other>	
Indoor/Outdoor Equivalent Piping Length	30 m

1. Cooling Calculation

(1) Temporary Selection of Indoor Units

Room1	
PEFY-P36	10.6 kW (Nominal)
Room2	
PEFY-P36	10.6 kW (Nominal)

(2) Total Indoor Units Capacity

$$P36 + P36 = P72$$

(3) Selection of Outdoor Unit

The P72 outdoor unit is selected as total indoor units capacity is P72

PUHY-P72	21.1 kW
----------	---------

(4) Total Indoor Units Capacity Correction Calculation

Room1	
Indoor Design Wet Bulb Temperature Correction (20°C)	1.02 (Refer to Fig.1)
Room2	
Indoor Design Wet Bulb Temperature Correction (18°C)	0.96 (Refer to Fig.1)

Total Indoor Units Capacity (CTi)

$$\begin{aligned} CTi &= \Sigma (\text{Indoor Unit Rating} \times \text{Indoor Design Temperature Correction}) \\ &= 10.6 \times 1.02 + 10.6 \times 0.96 \\ &= 20.9 \text{ kW} \end{aligned}$$

(5) Outdoor Unit Correction Calculation

Outdoor Design Dry Bulb Temperature Correction (37°C)	0.99 (Refer to Fig.2)
Piping Length Correction (30 m)	0.95 (Refer to Fig.3)

Total Outdoor Unit Capacity (CTo)

$$\begin{aligned} CTo &= \text{Outdoor Rating} \times \text{Outdoor Design Temperature Correction} \times \text{Piping Length Correction} \\ &= 21.1 \times 0.99 \times 0.95 \\ &= 19.8 \text{ kW} \end{aligned}$$

(6) Determination of Maximum System Capacity (CTx)

Comparison of Capacity between Total Indoor Units Capacity (CTi) and Total Outdoor Unit Capacity (CTo)

$$CTi = 20.9 > CTo = 19.8, \text{ thus, select } CTo.$$

$$CTx = CTo = 19.8 \text{ kW}$$

(7) Comparison with Essential Load

Against the essential load 18.5kW, the maximum system capacity is 19.8kW: Proper outdoor units have been selected.

(8) Calculation of Maximum Indoor Unit Capacity of Each Room

CTx = CTo, thus, calculate by the calculation below

Room1

$$\begin{aligned} &\text{Maximum Capacity} \times \text{Room1 Capacity after the Temperature Correction} / (\text{Room1,2 Total Capacity after the Temperature Correction}) \\ &= 19.8 \times (10.6 \times 1.02) / (10.6 \times 1.02 + 10.6 \times 0.96) \\ &= 10.2 \text{ kW} \quad \text{OK: fulfills the load 9.0kW} \end{aligned}$$

Room2

$$\begin{aligned} &\text{Maximum Capacity} \times \text{Room2 Capacity after the Temperature Correction} / (\text{Room1,2 Total Capacity after the Temperature Correction}) \\ &= 19.8 \times (10.6 \times 0.96) / (10.6 \times 1.02 + 10.6 \times 0.96) \\ &= 9.6 \text{ kW} \quad \text{OK: fulfills the load 9.5kW} \end{aligned}$$

Go on to the heating trial calculation since the selected units fulfill the cooling loads of Room 1, 2.

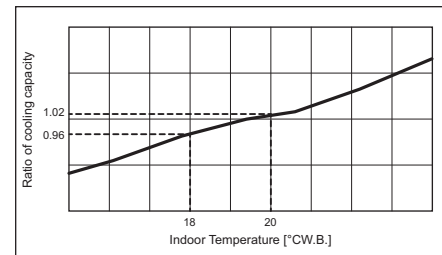

Fig.1 Indoor unit temperature correction  
To be used to correct indoor unit only

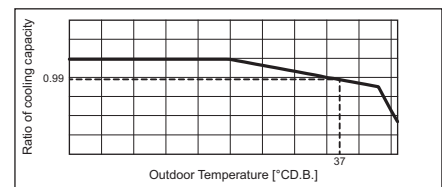

Fig.2 Outdoor unit temperature correction  
To be used to correct outdoor unit only

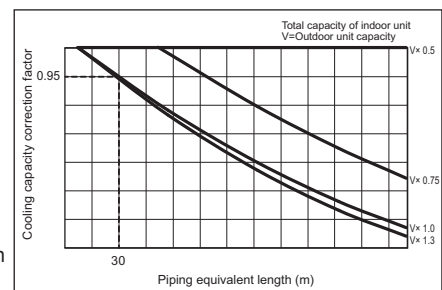

Fig.3 Correction of refrigerant piping length

PUHY-HP-T(S)NU-A, Y(S)NU-A

<Heating>

Design Condition	
Outdoor Design Wet Bulb Temperature	2 °C
Total Heating Load	18.2 kW
Room1	
Indoor Design Dry Bulb Temperature	25 °C
Heating Load	9.2 kW
Room2	
Indoor Design Dry Bulb Temperature	25 °C
Heating Load	9.0 kW
<Other>	
Indoor/Outdoor Equivalent Piping Length	30 m

2. Heating Calculation

(1) Temporary Selection of Indoor Units

Room1	PEFY-P36	11.7 kW (Nominal)
Room2	PEFY-P36	11.7 kW (Nominal)

(2) Total Indoor Units Capacity

$P36 + P36 = P72$

(3) Selection of Outdoor Unit

The P72 outdoor unit is selected as total indoor units capacity is P72

PUHY-P72	23.4 kW
----------	---------

(4) Total Indoor Units Capacity Correction Calculation

Room1	Indoor Design Dry Bulb Temperature Correction (25°C)	0.80 (Refer to Fig.4)
Room2	Indoor Design Dry Bulb Temperature Correction (25°C)	0.80 (Refer to Fig.4)

Total Indoor Units Capacity (CTi)

$$CTi = \sum (\text{Indoor Unit Rating} \times \text{Indoor Design Temperature Correction})$$

$$= 11.7 \times 0.80 + 11.7 \times 0.80$$

$$= 18.7 \text{ kW}$$

(5) Outdoor Unit Correction Calculation

Outdoor Design Wet Bulb Temperature Correction (2°C)	0.98 (Refer to Fig.5)
Piping Length Correction (30 m)	0.98 (Refer to Fig.6)
Defrost Correction	0.84 (Refer to Tbl.1)

Total Outdoor Unit Capacity (CTo)

$$CTo = \text{Outdoor Unit Rating} \times \text{Outdoor Design Temperature Correction} \times \text{Piping Length Correction} \times \text{Defrost Correction}$$

$$= 23.4 \times 0.98 \times 0.98 \times 0.84$$

$$= 18.8 \text{ kW}$$

(6) Determination of Maximum System Capacity (CTx)

Comparison of Capacity between Total Indoor Units Capacity (CTi) and Total Outdoor Unit Capacity (CTo)

$CTi = 18.7 < CTo = 18.8$ , thus, select CTi.

$CTx = CTi = 18.7 \text{ kW}$

(7) Comparison with Essential Load

Against the essential load 18.2kW, the maximum system capacity is 18.7kW: Proper outdoor units have been selected.

(8) Calculation of Maximum Indoor Unit Capacity of Each Room

$CTx = CTi$ , thus, calculate by the calculation below

Room1	Indoor Unit Rating × Indoor Design Temperature Correction	
	$= 11.7 \times 0.80$	
	$= 9.4 \text{ kW}$	<b>OK: fulfills the load 9.2kW</b>

Room2	Indoor Unit Rating × Indoor Design Temperature Correction	
	$= 11.7 \times 0.80$	
	$= 9.4 \text{ kW}$	<b>OK: fulfills the load 9.0kW</b>

Completed selecting units since the selected units fulfill the heating loads of Room 1, 2.

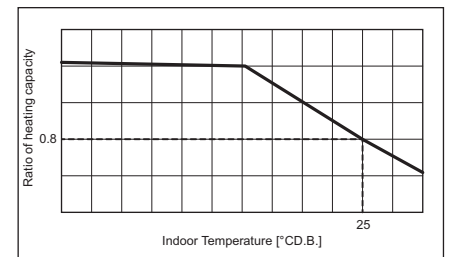

Fig.4 Indoor unit temperature correction  
To be used to correct indoor unit only

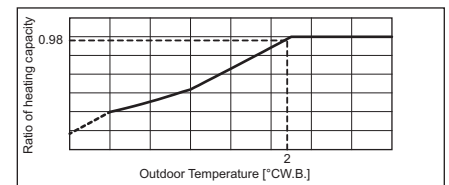

Fig.5 Outdoor unit temperature correction  
To be used to correct outdoor unit only

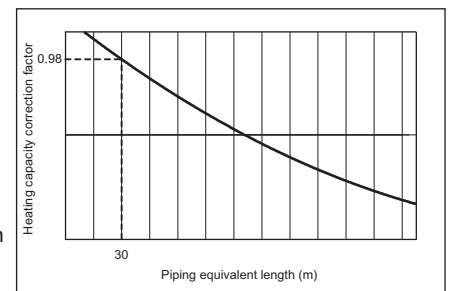

Fig.6 Correction of refrigerant piping length

Tbl.1 Table of correction factor at frost and defrost

Outdoor inlet air temp. °CWB	6	4	2	1	0	-2	-4	-6	-8	-10	-20
Outdoor inlet air temp. °FWB	43	39	36	34	32	28	25	21	18	14	-4
PUHY-P72	1.00	0.95	0.84	0.83	0.83	0.87	0.90	0.95	0.95	0.95	0.95
PUHY-P96	1.00	0.95	0.84	0.83	0.83	0.87	0.90	0.95	0.95	0.95	0.95
PUHY-P120	1.00	0.93	0.82	0.80	0.82	0.86	0.90	0.90	0.95	0.95	0.95
PUHY-P144	1.00	0.93	0.82	0.80	0.82	0.86	0.90	0.90	0.95	0.95	0.95
PUHY-P168	1.00	0.93	0.82	0.80	0.82	0.86	0.90	0.90	0.95	0.95	0.95

## 3. Power input of outdoor unit

&lt;Cooling&gt;

**(1) Nominal power input of outdoor unit** **4.55 kW (Nominal)****(2) Calculation of the average indoor temperature power input coefficient**

Coefficient of the outdoor unit for indoor unit 1 (Outdoor temp. 37 °CD.B., Indoor temp. 20 °CW.B.)

1.09

Coefficient of the outdoor unit for indoor unit 2 (Outdoor temp. 37 °CD.B., Indoor temp. 17.8 °CW.B.)

1.03

$$\text{Average indoor temp. power input coefficient } (C_{ave}) = \sum_{k=1}^n \{c_k \times (M_k / \sum_{k=1}^n M_k)\}$$

n: Total number of the indoor units

k: Number of the indoor unit

c<sub>k</sub>: Outdoor unit power input coefficient of k indoor unit room temp.M<sub>k</sub>: Number part of the k indoor unit model (e.g. P36 → 36)

$$= 1.09 \times 36 / (36 + 36) + 1.03 \times 36 / (36 + 36)$$

$$= 1.06$$

**(3) No need to consider Coefficient of the partial load  $f(CTi/CTo)$**  -**(4) Outdoor power input (P<sub>lo</sub>)**Maximum System Capacity (CT<sub>x</sub>) = Total Outdoor unit Capacity (CT<sub>o</sub>), so use the following formulaP<sub>lo</sub> = Outdoor unit Cooling Nominal Power Input × Correction Coefficient of Indoor temperature

$$= 4.55 \times 1.06$$

$$= 4.82 \text{ kW}$$

&lt;Heating&gt;

**(1) Nominal power input of outdoor unit** **5.48 kW (Nominal)****(2) Calculation of the average indoor temperature power input coefficient**Coefficient of the outdoor unit for indoor unit 1 (Outdoor temp. 2 °CW.B., Indoor temp. 25 °CD.B.)  
0.80Coefficient of the outdoor unit for indoor unit 2 (Outdoor temp. 2 °CW.B., Indoor temp. 25 °CD.B.)  
0.80Average indoor temp. power input coefficient ( $C_{ave}$ ) =  $\sum_{k=1}^n \{c_k \times (M_k / \sum_{k=1}^n M_k)\}$ 

n: Total number of the indoor units

k: Number of the indoor unit

 $c_k$ : Outdoor unit power input coefficient of k indoor unit room temp. $M_k$ : Number part of the k indoor unit model (e.g. P36 → 36)

$$= 0.8 \times 36 / (36 + 36) + 0.8 \times 36 / (36 + 36)$$

$$= 0.80$$

**(3) Coefficient of the partial load  $f$  (CTi/CTo)** **0.94****(4) Outdoor power input (Plo)**

Maximum System Capacity (CTx) = Total Indoor unit Capacity (CTi), so use the following formula

$$P_{lo} = \text{Outdoor unit Heating Nominal Power Input} \times \text{Correction Coefficient of Indoor temperature} \times f \text{ (CTi/CTo)}$$

$$= 5.48 \times 0.8 \times 0.94$$

$$= 4.12 \text{ kW}$$

<Cooling>

Design Condition	
Outdoor Design Dry Bulb Temperature	99 °F
Total Cooling Load	63,000 BTU/h
Room1	
Indoor Design Dry Bulb Temperature	81 °F
Indoor Design Wet Bulb Temperature	68 °F
Cooling Load	31,000 BTU/h
Room2	
Indoor Design Dry Bulb Temperature	75 °F
Indoor Design Wet Bulb Temperature	64 °F
Cooling Load	32,000 BTU/h
<Other>	
Indoor/Outdoor Equivalent Piping Length	100 ft.

1. Cooling Calculation

(1) Temporary Selection of Indoor Units

Room1	
PEFY-P36	36,000 BTU/h (Nominal)
Room2	
PEFY-P36	36,000 BTU/h (Nominal)

(2) Total Indoor Units Capacity

$P36 + P36 = P72$

(3) Selection of Outdoor Unit

The P72 outdoor unit is selected as total indoor units capacity is P72

PUHY-P72	72,000 BTU/h
----------	--------------

(4) Total Indoor Units Capacity Correction Calculation

Room1	
Indoor Design Wet Bulb Temperature Correction (68°F)	1.02 (Refer to Fig.1)
Room2	
Indoor Design Wet Bulb Temperature Correction (64°F)	0.96 (Refer to Fig.1)

Total Indoor Units Capacity (CTi)

$$CTi = \sum (\text{Indoor Unit Rating} \times \text{Indoor Design Temperature Correction})$$

$$= 36,000 \times 1.02 + 36,000 \times 0.96$$

$$= 71,200 \text{ BTU/h}$$

(5) Outdoor Unit Correction Calculation

Outdoor Design Dry Bulb Temperature Correction (99°F)	0.99 (Refer to Fig.2)
Piping Length Correction (100 ft.)	0.95 (Refer to Fig.3)

Total Outdoor Unit Capacity (CTo)

$$CTo = \text{Outdoor Rating} \times \text{Outdoor Design Temperature Correction} \times \text{Piping Length Correction}$$

$$= 72,000 \times 0.99 \times 0.95$$

$$= 67,700 \text{ BTU/h}$$

(6) Determination of Maximum System Capacity (CTx)

Comparison of Capacity between Total Indoor Units Capacity (CTi) and Total Outdoor Unit Capacity (CTo)

$CTi = 71,200 > CTo = 67,700$ , thus, select CTo.

$CTx = CTo = 67,700 \text{ BTU/h}$

(7) Comparison with Essential Load

Against the essential load 63,000BTU/h, the maximum system capacity is 67,700BTU/h: Proper outdoor units have been selected.

(8) Calculation of Maximum Indoor Unit Capacity of Each Room

$CTx = CTo$ , thus, calculate by the calculation below

Room1

$$\text{Maximum Capacity} \times \text{Room1 Capacity after the Temperature Correction} / (\text{Room1,2 Total Capacity after the Temperature Correction})$$

$$= 67,700 \times (36,000 \times 1.02) / (36,000 \times 1.02 + 36,000 \times 0.96)$$

$$= 34,800 \text{ BTU/h} \quad \text{OK: fulfills the load 31,000BTU/h}$$

Room2

$$\text{Maximum Capacity} \times \text{Room2 Capacity after the Temperature Correction} / (\text{Room1,2 Total Capacity after the Temperature Correction})$$

$$= 67,700 \times (36,000 \times 0.96) / (36,000 \times 1.02 + 36,000 \times 0.96)$$

$$= 32,800 \text{ BTU/h} \quad \text{OK: fulfills the load 32,000BTU/h}$$

Go on to the heating trial calculation since the selected units fulfill the cooling loads of Room 1, 2.

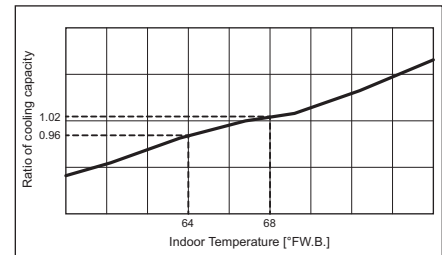

Fig.1 Indoor unit temperature correction  
To be used to correct indoor unit only

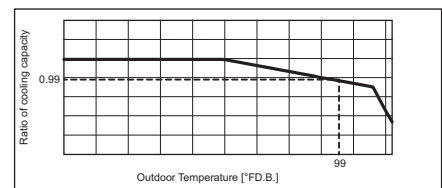

Fig.2 Outdoor unit temperature correction  
To be used to correct outdoor unit only

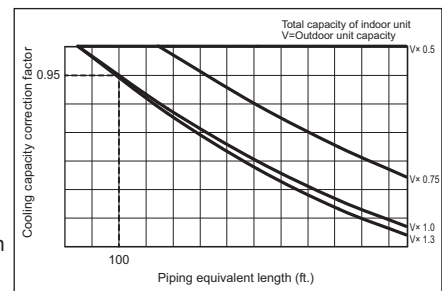

Fig.3 Correction of refrigerant piping length

PUHY-HP-T(S)NU-A, Y(S)NU-A

<Heating>

Design Condition	
Outdoor Design Wet Bulb Temperature	37 °F
Total Heating Load	62,000 BTU/h
Room1	
Indoor Design Dry Bulb Temperature	77 °F
Heating Load	31,000 BTU/h
Room2	
Indoor Design Dry Bulb Temperature	77 °F
Heating Load	31,000 BTU/h
<Other>	
Indoor/Outdoor Equivalent Piping Length	100 ft.

2. Heating Calculation

(1) Temporary Selection of Indoor Units

Room1	PEFY-P36	40,000 BTU/h (Nominal)
Room2	PEFY-P36	40,000 BTU/h (Nominal)

(2) Total Indoor Units Capacity

$P36 + P36 = P72$

(3) Selection of Outdoor Unit

The P72 outdoor unit is selected as total indoor units capacity is P72

PUHY-P72	80,000 BTU/h
----------	--------------

(4) Total Indoor Units Capacity Correction Calculation

Room1	Indoor Design Dry Bulb Temperature Correction (77°F)	0.80 (Refer to Fig.4)
Room2	Indoor Design Dry Bulb Temperature Correction (77°F)	0.80 (Refer to Fig.4)

Total Indoor Units Capacity (CTi)

$$CTi = \sum (\text{Indoor Unit Rating} \times \text{Indoor Design Temperature Correction})$$

$$= 40,000 \times 0.80 + 40,000 \times 0.80$$

$$= 64,000 \text{ BTU/h}$$

(5) Outdoor Unit Correction Calculation

Outdoor Design Wet Bulb Temperature Correction (37°F)	0.99 (Refer to Fig.5)
Piping Length Correction (100 ft.)	0.98 (Refer to Fig.6)
Defrost Correction	0.87 (Refer to Tbl.1)

Total Outdoor Unit Capacity (CTo)

$$CTo = \text{Outdoor Unit Rating} \times \text{Outdoor Design Temperature Correction} \times \text{Piping Length Correction} \times \text{Defrost Correction}$$

$$= 80,000 \times 0.99 \times 0.98 \times 0.87$$

$$= 67,000 \text{ BTU/h}$$

(6) Determination of Maximum System Capacity (CTx)

Comparison of Capacity between Total Indoor Units Capacity (CTi) and Total Outdoor Unit Capacity (CTo)

$CTi = 64,000 < CTo = 67,000$ , thus, select CTi.

$CTx = CTi = 64,000 \text{ BTU/h}$

(7) Comparison with Essential Load

Against the essential load 62,000BTU/h, the maximum system capacity is 64,000BTU/h: Proper outdoor units have been selected.

(8) Calculation of Maximum Indoor Unit Capacity of Each Room

$CTx = CTi$ , thus, calculate by the calculation below

Room1	Indoor Unit Rating × Indoor Design Temperature Correction	
	$= 40,000 \times 0.80$	
	$= 32,000 \text{ BTU/h}$	<b>OK: fulfills the load 31,000BTU/h</b>

Room2	Indoor Unit Rating × Indoor Design Temperature Correction	
	$= 40,000 \times 0.80$	
	$= 32,000 \text{ BTU/h}$	<b>OK: fulfills the load 31,000BTU/h</b>

Completed selecting units since the selected units fulfill the heating loads of Room 1, 2.

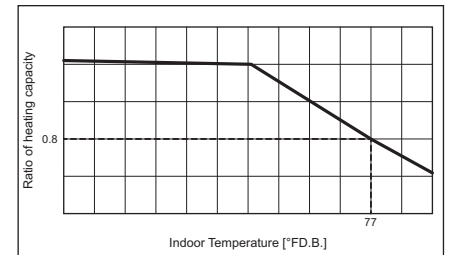

Fig.4 Indoor unit temperature correction  
To be used to correct indoor unit only

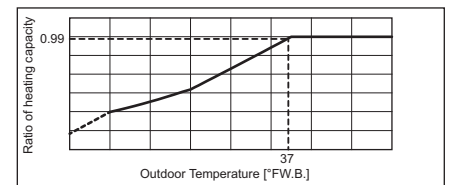

Fig.5 Outdoor unit temperature correction  
To be used to correct outdoor unit only

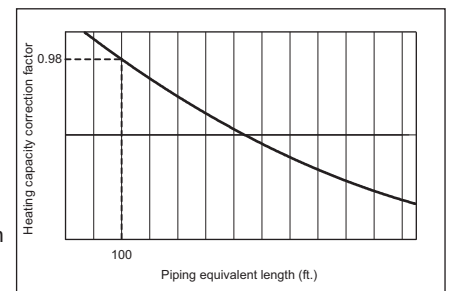

Fig.6 Correction of refrigerant piping length

Tbl.1 Table of correction factor at frost and defrost

Outdoor inlet air temp. °CWB	6	4	2	1	0	-2	-4	-6	-8	-10	-20
Outdoor inlet air temp. °FWB	43	39	36	34	32	28	25	21	18	14	-4
PUHY-P72	1.00	0.95	0.84	0.83	0.83	0.87	0.90	0.95	0.95	0.95	0.95
PUHY-P96	1.00	0.95	0.84	0.83	0.83	0.87	0.90	0.95	0.95	0.95	0.95
PUHY-P120	1.00	0.93	0.82	0.80	0.82	0.86	0.90	0.90	0.95	0.95	0.95
PUHY-P144	1.00	0.93	0.82	0.80	0.82	0.86	0.90	0.90	0.95	0.95	0.95
PUHY-P168	1.00	0.93	0.82	0.80	0.82	0.86	0.90	0.90	0.95	0.95	0.95



## 3. Power input of outdoor unit

&lt;Cooling&gt;

**(1) Nominal power input of outdoor unit** **4.55 kW (Nominal)****(2) Calculation of the average indoor temperature power input coefficient**

Coefficient of the outdoor unit for indoor unit 1 (Outdoor temp. 99 °FD.B., Indoor temp. 68 °FW.B.)

1.09

Coefficient of the outdoor unit for indoor unit 2 (Outdoor temp. 99 °FD.B., Indoor temp. 64 °FW.B.)

1.03

Average indoor temp. power input coefficient ( $C_{ave}$ ) =  $\sum_{k=1}^n \{c_k \times (M_k / \sum_{k=1}^n M_k)\}$ 

n: Total number of the indoor units

k: Number of the indoor unit

 $c_k$ : Outdoor unit power input coefficient of k indoor unit room temp. $M_k$ : Number part of the k indoor unit model (e.g. P36 → 36)=  $1.09 \times 36 / (36 + 36) + 1.03 \times 36 / (36 + 36)$ 

= 1.06

**(3) No need to consider Coefficient of the partial load  $f(CTi/CTo)$**  -**(4) Outdoor power input (P<sub>lo</sub>)**Maximum System Capacity (CT<sub>x</sub>) = Total Outdoor unit Capacity (CT<sub>o</sub>), so use the following formulaP<sub>lo</sub> = Outdoor unit Cooling Nominal Power Input × Correction Coefficient of Indoor temperature=  $4.55 \times 1.06$ 

= 4.82 kW

&lt;Heating&gt;

**(1) Nominal power input of outdoor unit** **5.48 kW (Nominal)****(2) Calculation of the average indoor temperature power input coefficient**Coefficient of the outdoor unit for indoor unit 1 (Outdoor temp. 35.6 °FW.B., Indoor temp. 77 °FD.B.)  
0.80Coefficient of the outdoor unit for indoor unit 2 (Outdoor temp. 35.6 °FW.B., Indoor temp. 77 °FD.B.)  
0.80

$$\text{Average indoor temp. power input coefficient } (C_{ave}) = \sum_{k=1}^n \{c_k \times (M_k / \sum_{k=1}^n M_k)\}$$

n: Total number of the indoor units

k: Number of the indoor unit

c<sub>k</sub>: Outdoor unit power input coefficient of k indoor unit room temp.M<sub>k</sub>: Number part of the k indoor unit model (e.g. P36 → 36)

$$= 0.8 \times 36 / (36 + 36) + 0.8 \times 36 / (36 + 36)$$

$$= 0.80$$

**(3) Coefficient of the partial load  $f$  (CTi/CTo)** **0.92****(4) Outdoor power input (P<sub>lo</sub>)**Maximum System Capacity (CT<sub>x</sub>) = Total Indoor unit Capacity (CT<sub>i</sub>), so use the following formula

$$P_{lo} = \text{Outdoor unit Heating Nominal Power Input} \times \text{Correction Coefficient of Indoor temperature} \times f \text{ (CTi/CTo)}$$

$$= 5.48 \times 0.8 \times 0.92$$

$$= 4.03 \text{ kW}$$

8-2. Correction by temperature

CITY MULTI could have varied capacity at different designing temperature. Using the nominal cooling/heating capacity value and the ratio below, the capacity can be observed at various temperature.

PUHY-HP-T(S)NU-A, Y(S)NU-A

PUHY-		HP72TNU/YNU	
		Non-Ducted	Ducted
Nominal cooling capacity	BTU/h	72,000	
	kW	21.1	
	Input kW	5.39	

Indoor unit temperature correction

To be used to correct indoor unit capacity only

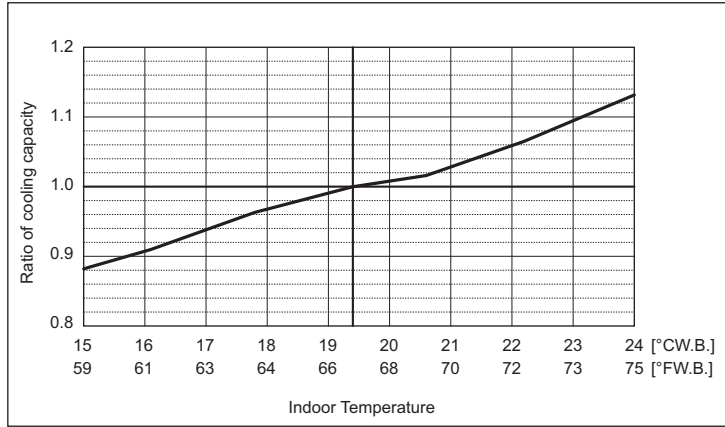

Outdoor unit temperature correction

To be used to correct outdoor unit only

Outdoor unit capacity is NOT affected by the indoor temperature.

Outdoor unit power input is affected by the indoor and outdoor temperatures. Please consult the sales office for details.

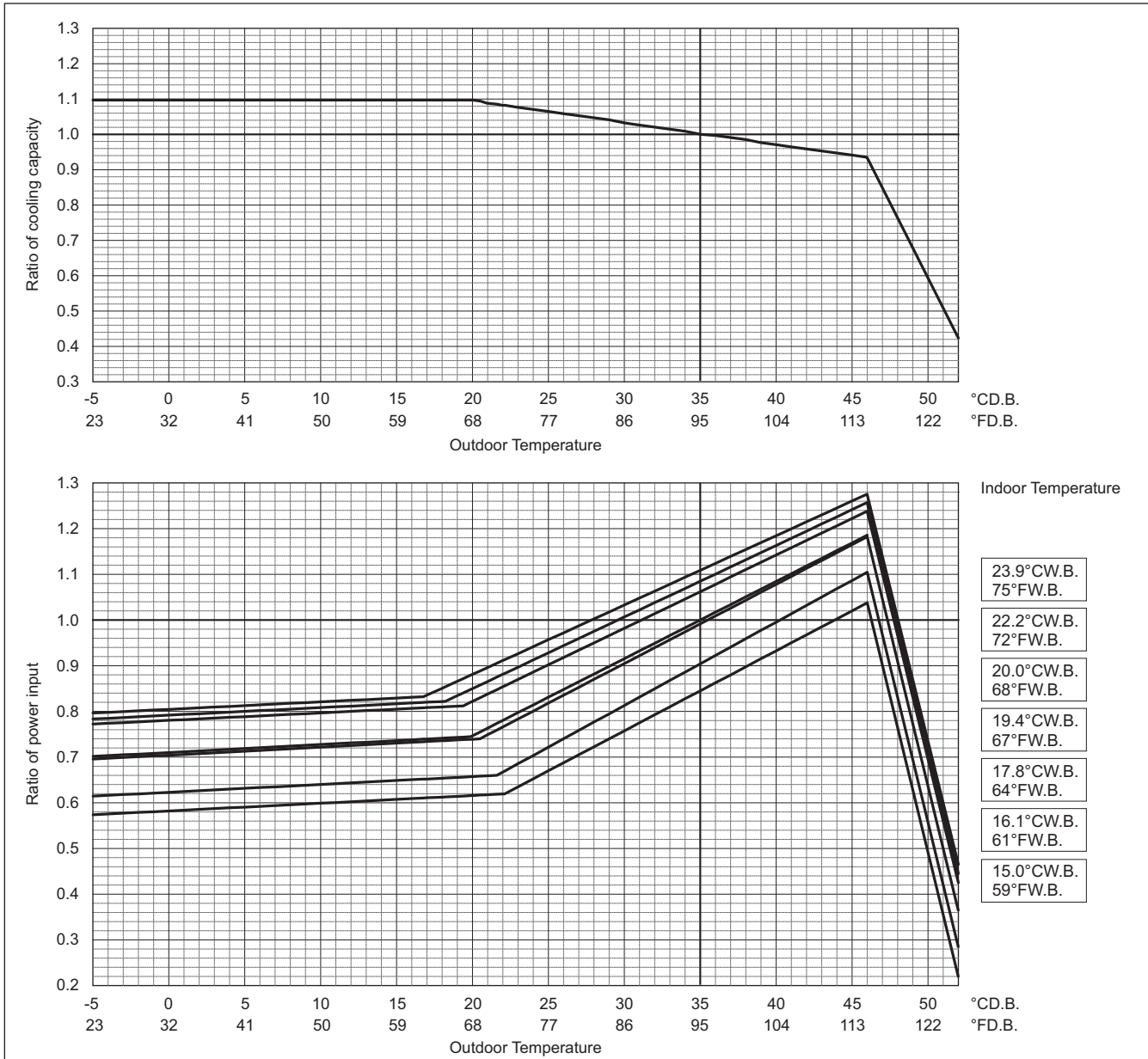

PUHY-		HP72TNU/YNU	
		Non-Ducted	Ducted
Nominal Heating capacity	BTU/h	80,000	
	kW	23.4	
	Input kW	5.33	

**Indoor unit temperature correction**

To be used to correct indoor unit capacity only

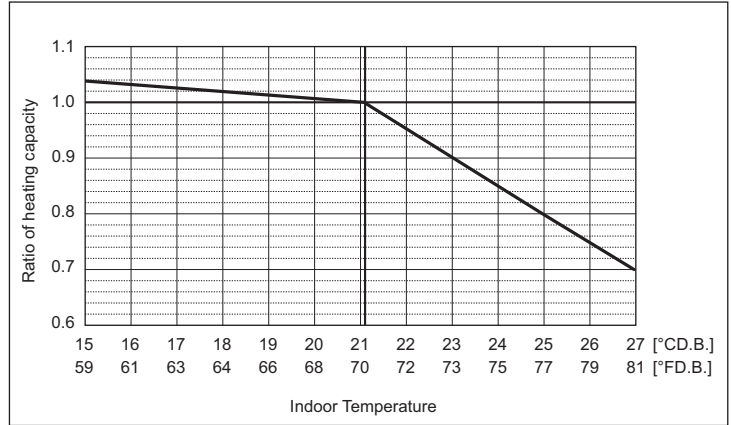

**Outdoor unit temperature correction**

To be used to correct outdoor unit only

Outdoor unit capacity is NOT affected by the indoor temperature.

Outdoor unit power input is affected by the indoor and outdoor temperatures. Please consult the sales office for details.

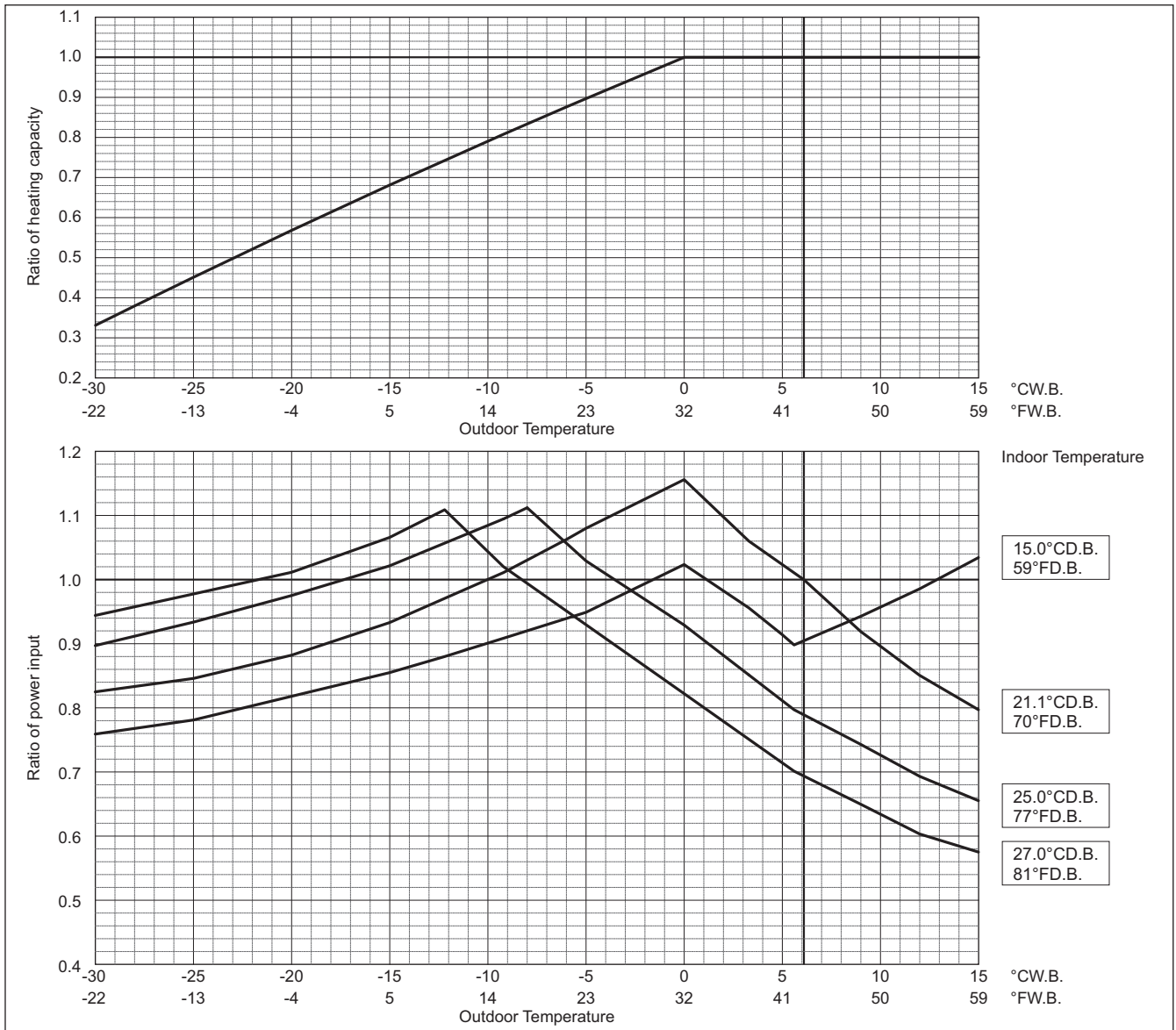

PUHY-HP-T(S)NU-A, Y(S)NU-A

PUHY-HP-T(S)NU-A, Y(S)NU-A

PUHY-		HP96TNU/YNU	
		Non-Ducted	Ducted
Nominal cooling capacity	BTU/h	96,000	
	kW	28.1	
	Input kW	6.23	

**Indoor unit temperature correction**  
To be used to correct indoor unit capacity only

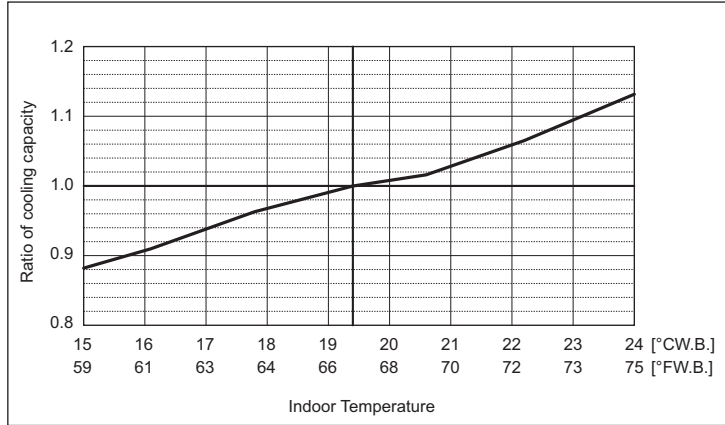

**Outdoor unit temperature correction**

To be used to correct outdoor unit only  
Outdoor unit capacity is NOT affected by the indoor temperature.  
Outdoor unit power input is affected by the indoor and outdoor temperatures. Please consult the sales office for details.

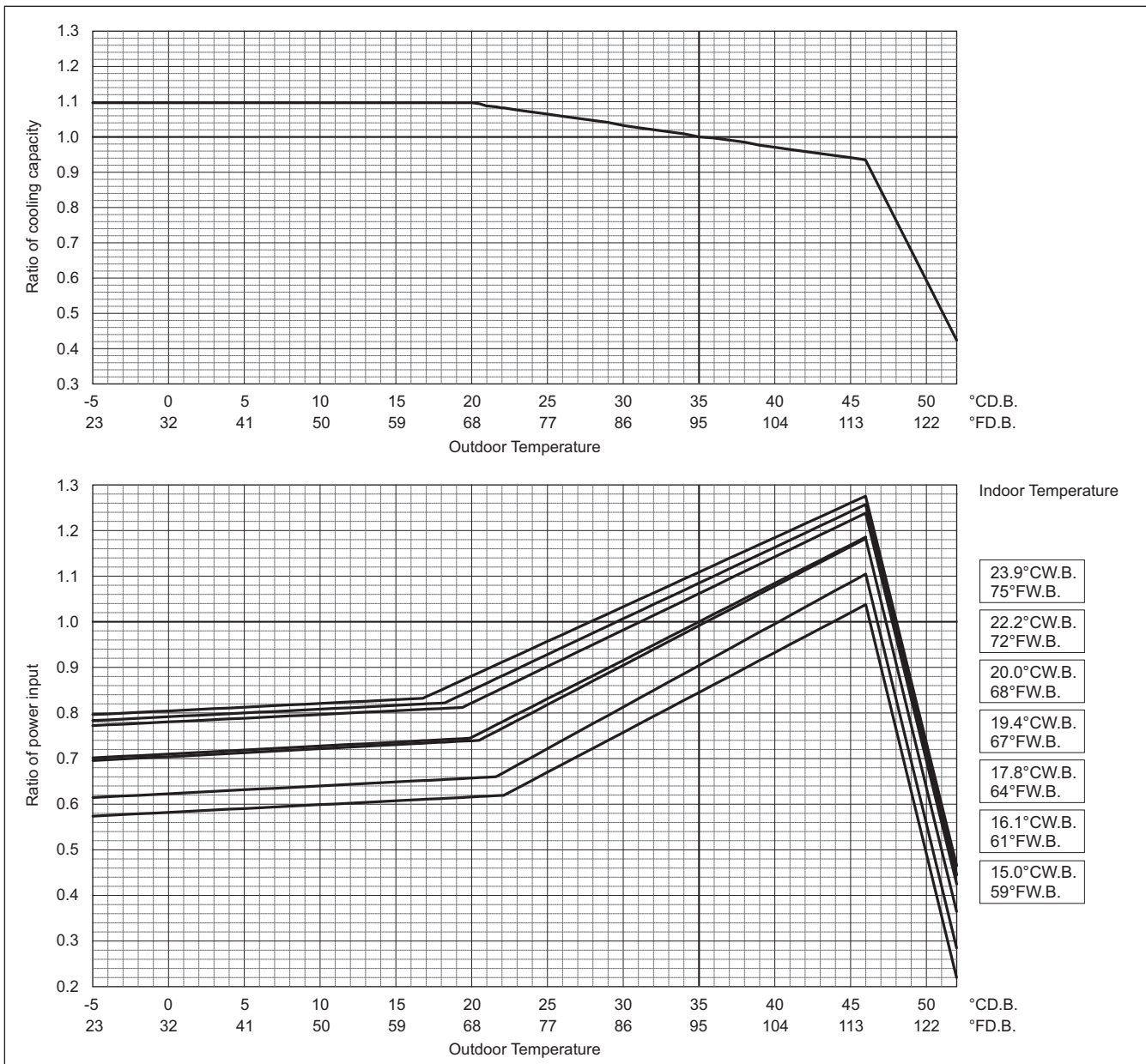

PUHY-		HP96TNU/YNU	
		Non-Ducted	Ducted
Nominal Heating capacity	BTU/h	108,000	
	kW	31.7	
	Input kW	7.33	

**Indoor unit temperature correction**

To be used to correct indoor unit capacity only

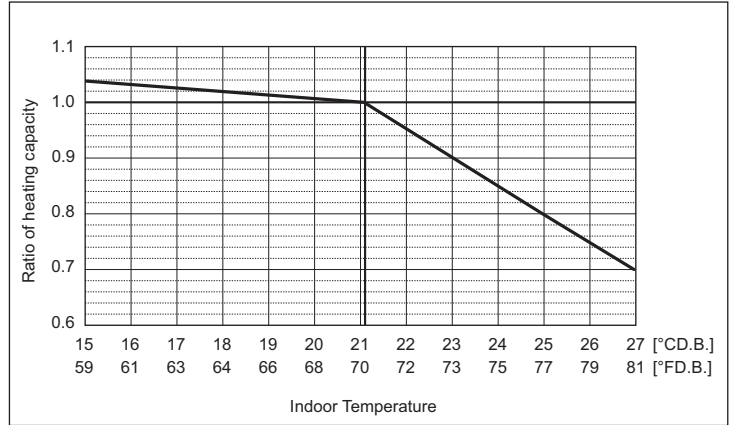

**Outdoor unit temperature correction**

To be used to correct outdoor unit only

Outdoor unit capacity is NOT affected by the indoor temperature.

Outdoor unit power input is affected by the indoor and outdoor temperatures. Please consult the sales office for details.

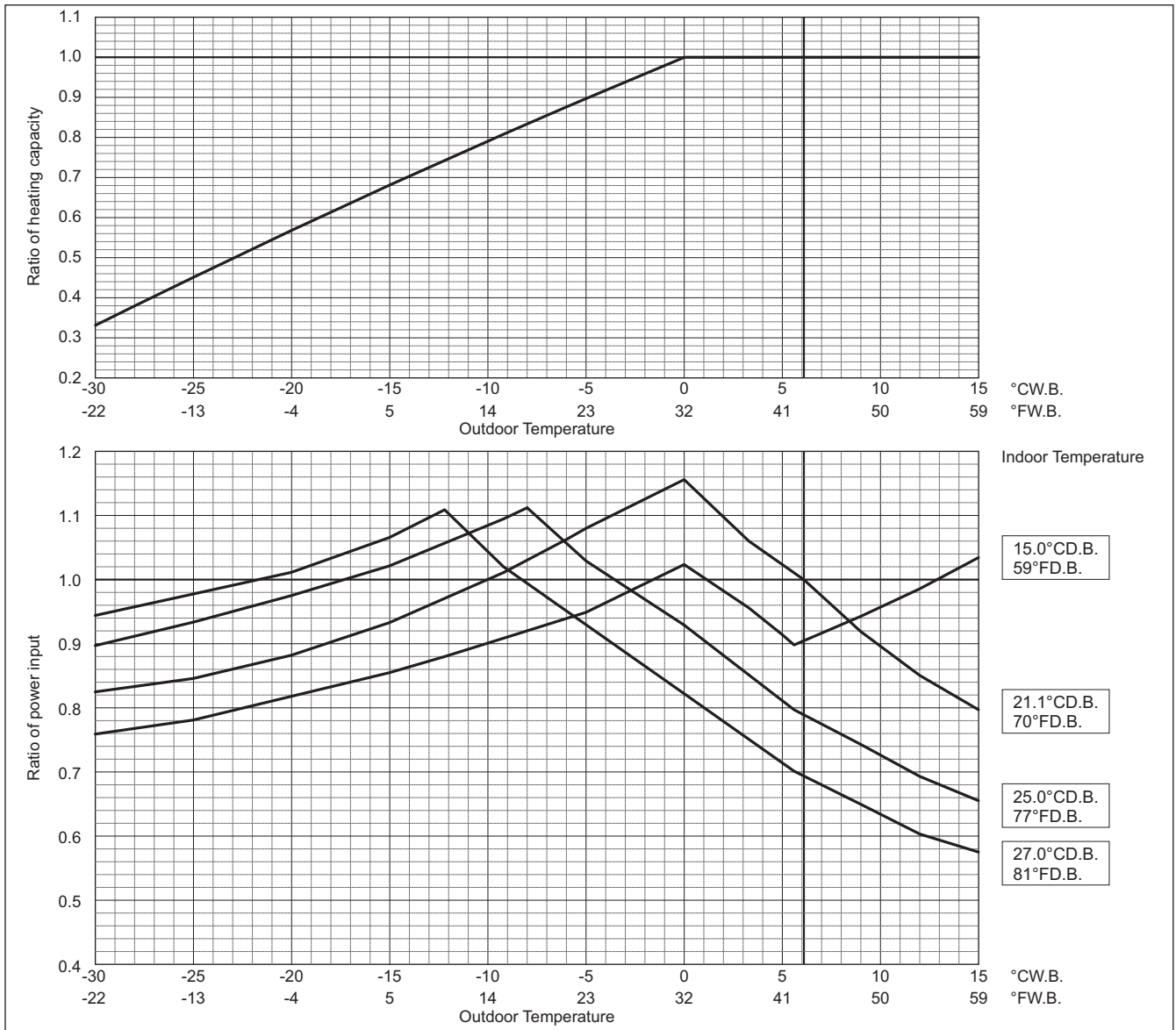

PUHY-HP-T(S)NU-A, Y(S)NU-A



PUHY-HP-T(S)NU-A, Y(S)NU-A

PUHY-		HP120TNU/YNU	
		Non-Ducted	Ducted
Nominal cooling capacity	BTU/h	120,000	
	kW	35.2	
	Input kW	8.53	

**Indoor unit temperature correction**  
To be used to correct indoor unit capacity only

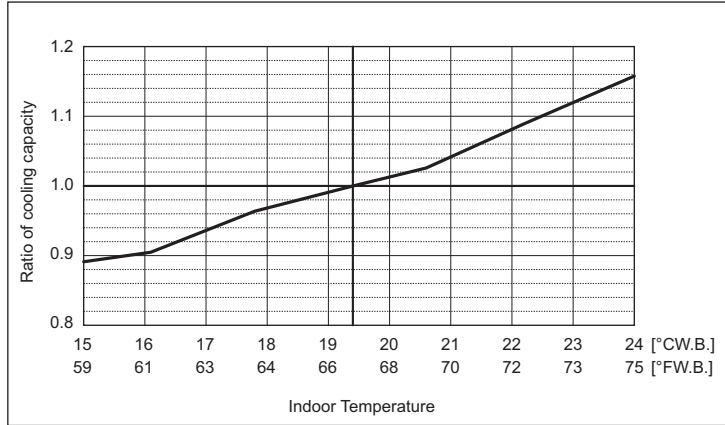

**Outdoor unit temperature correction**

To be used to correct outdoor unit only  
Outdoor unit capacity is NOT affected by the indoor temperature.  
Outdoor unit power input is affected by the indoor and outdoor temperatures. Please consult the sales office for details.

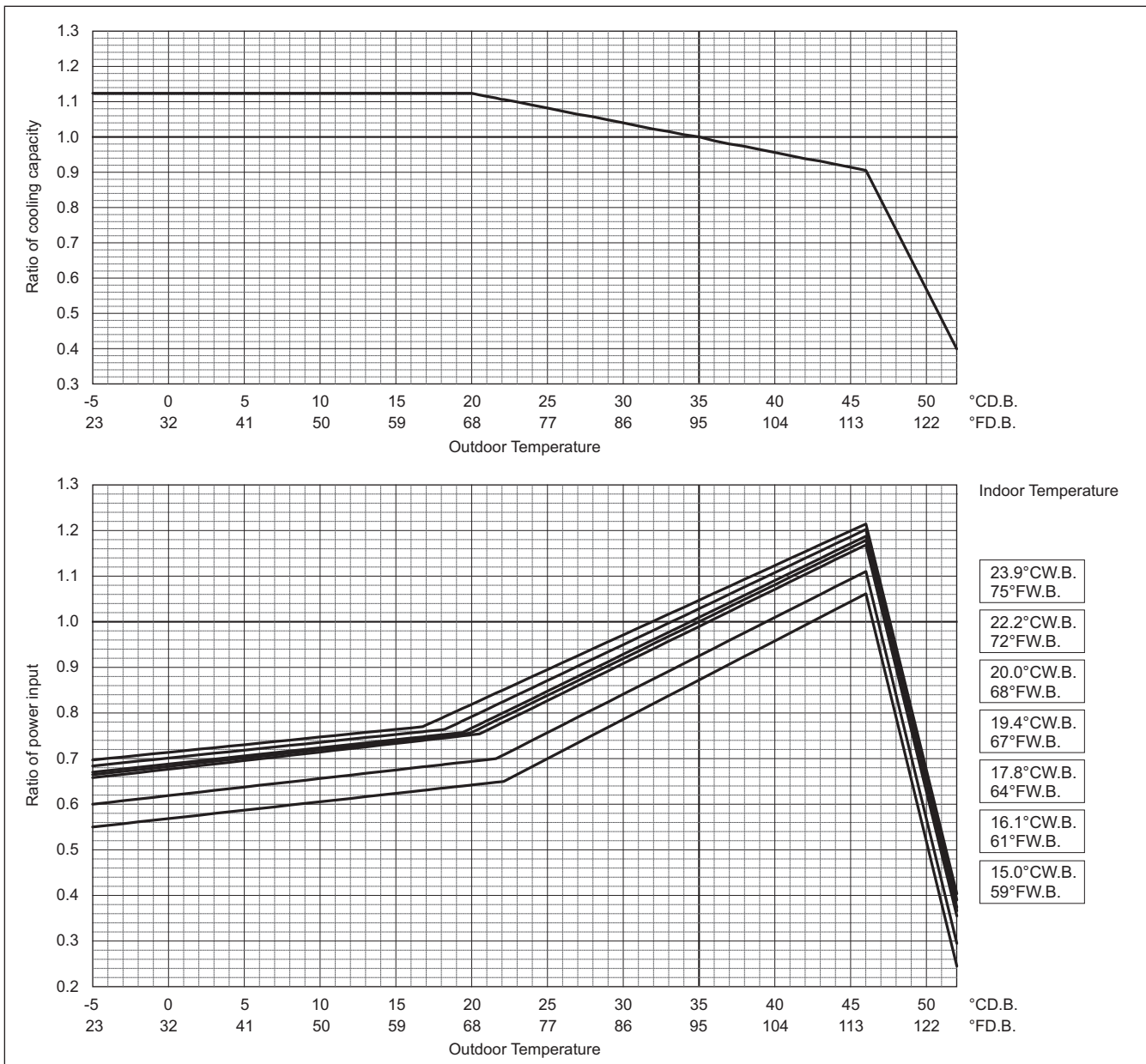

PUHY-		HP120TNU/YNU	
		Non-Ducted	Ducted
Nominal Heating capacity	BTU/h	135,000	
	kW	39.6	
	Input kW	9.63	

**Indoor unit temperature correction**

To be used to correct indoor unit capacity only

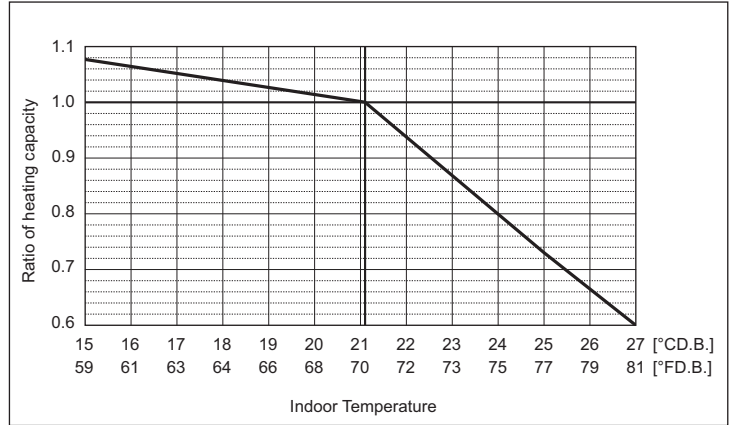

**Outdoor unit temperature correction**

To be used to correct outdoor unit only

Outdoor unit capacity is NOT affected by the indoor temperature.

Outdoor unit power input is affected by the indoor and outdoor temperatures. Please consult the sales office for details.

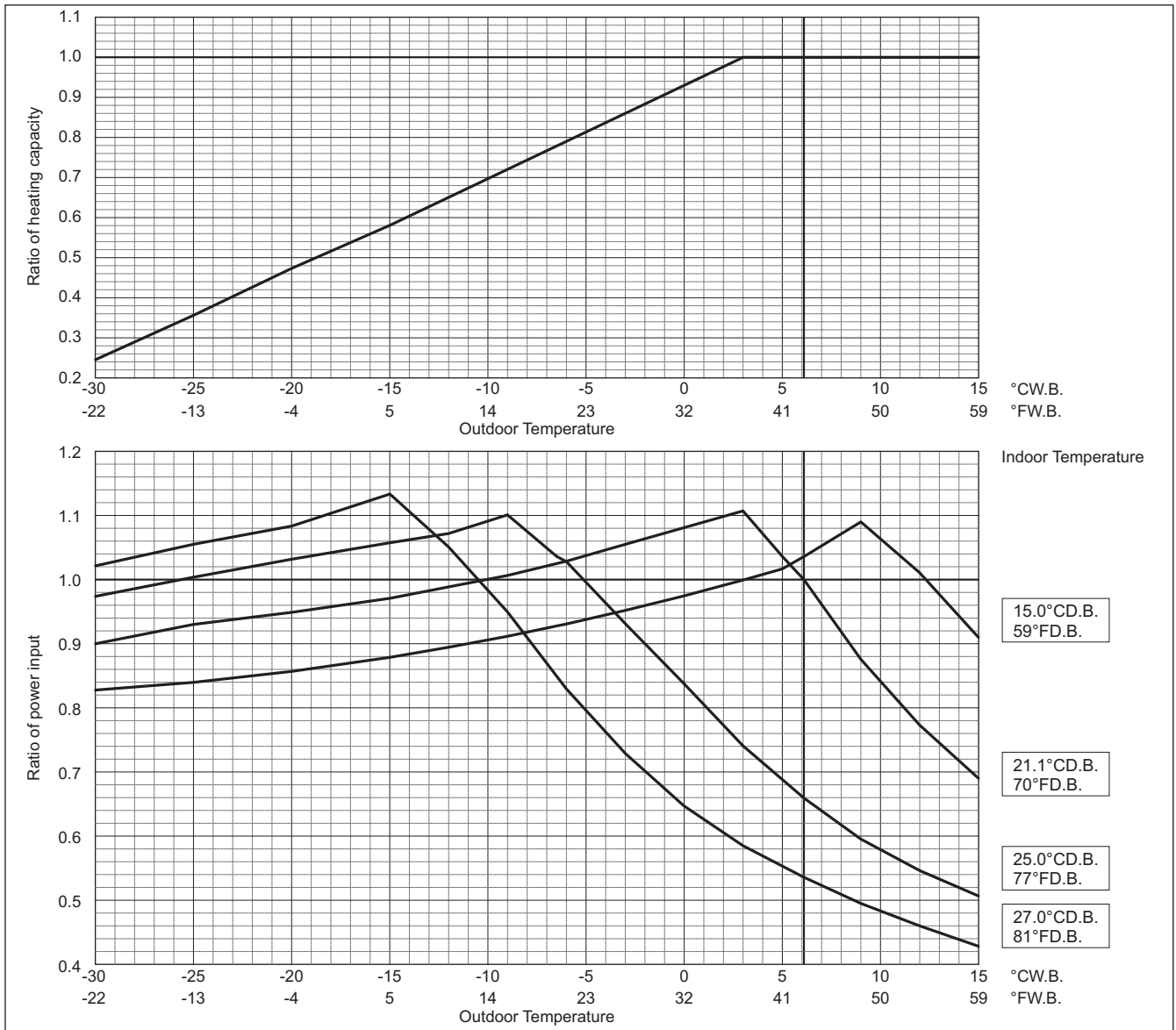

PUHY-HP-T(S)NU-A, Y(S)NU-A

PUHY-HP-T(S)NU-A, Y(S)NU-A

PUHY-		HP144TSNU/YSNU	
		Non-Ducted	Ducted
Nominal cooling capacity	BTU/h	144,000	
	kW	42.2	
	Input kW	12.20	

**Indoor unit temperature correction**  
To be used to correct indoor unit capacity only

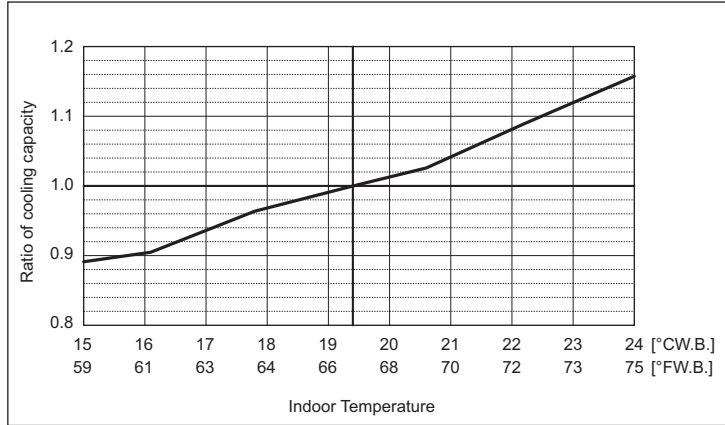

**Outdoor unit temperature correction**

To be used to correct outdoor unit only  
Outdoor unit capacity is NOT affected by the indoor temperature.  
Outdoor unit power input is affected by the indoor and outdoor temperatures. Please consult the sales office for details.

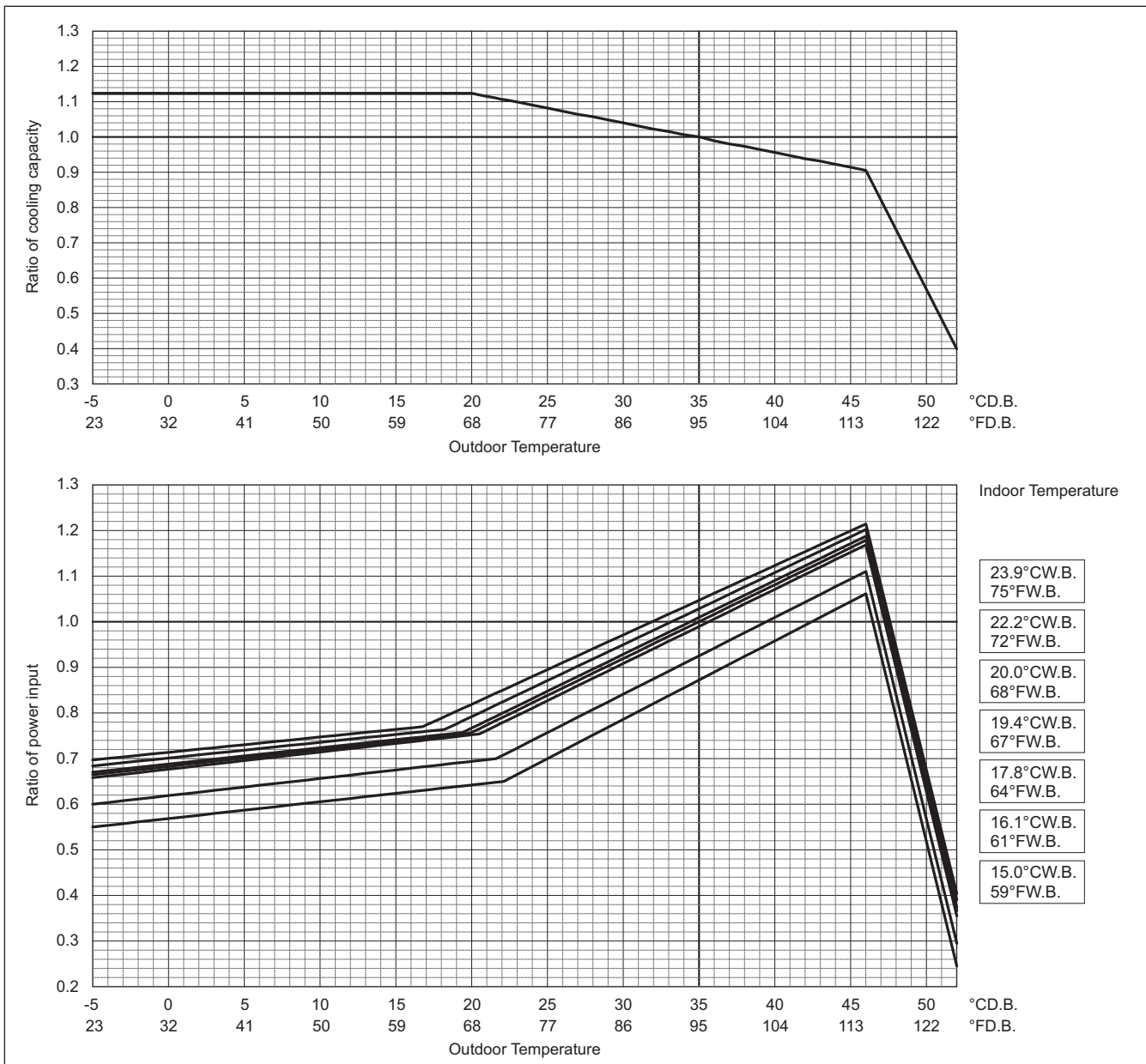

PUHY-		HP144TSNU/YSNU	
		Non-Ducted	Ducted
Nominal Heating capacity	BTU/h	160,000	
	kW	46.9	
	Input kW	11.70	

**Indoor unit temperature correction**

To be used to correct indoor unit capacity only

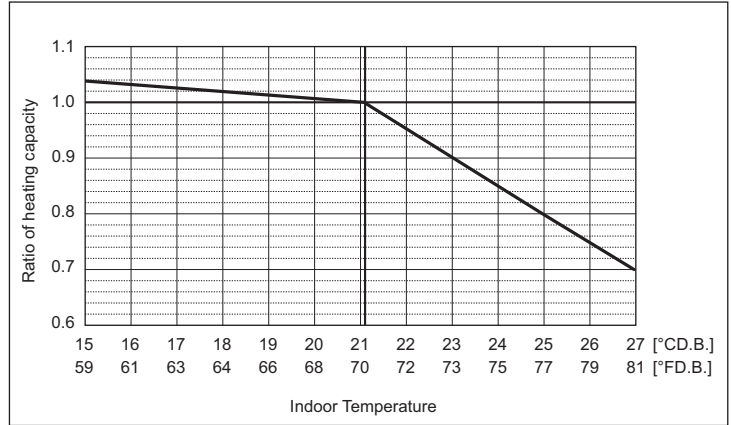

**Outdoor unit temperature correction**

To be used to correct outdoor unit only

Outdoor unit capacity is NOT affected by the indoor temperature.

Outdoor unit power input is affected by the indoor and outdoor temperatures. Please consult the sales office for details.

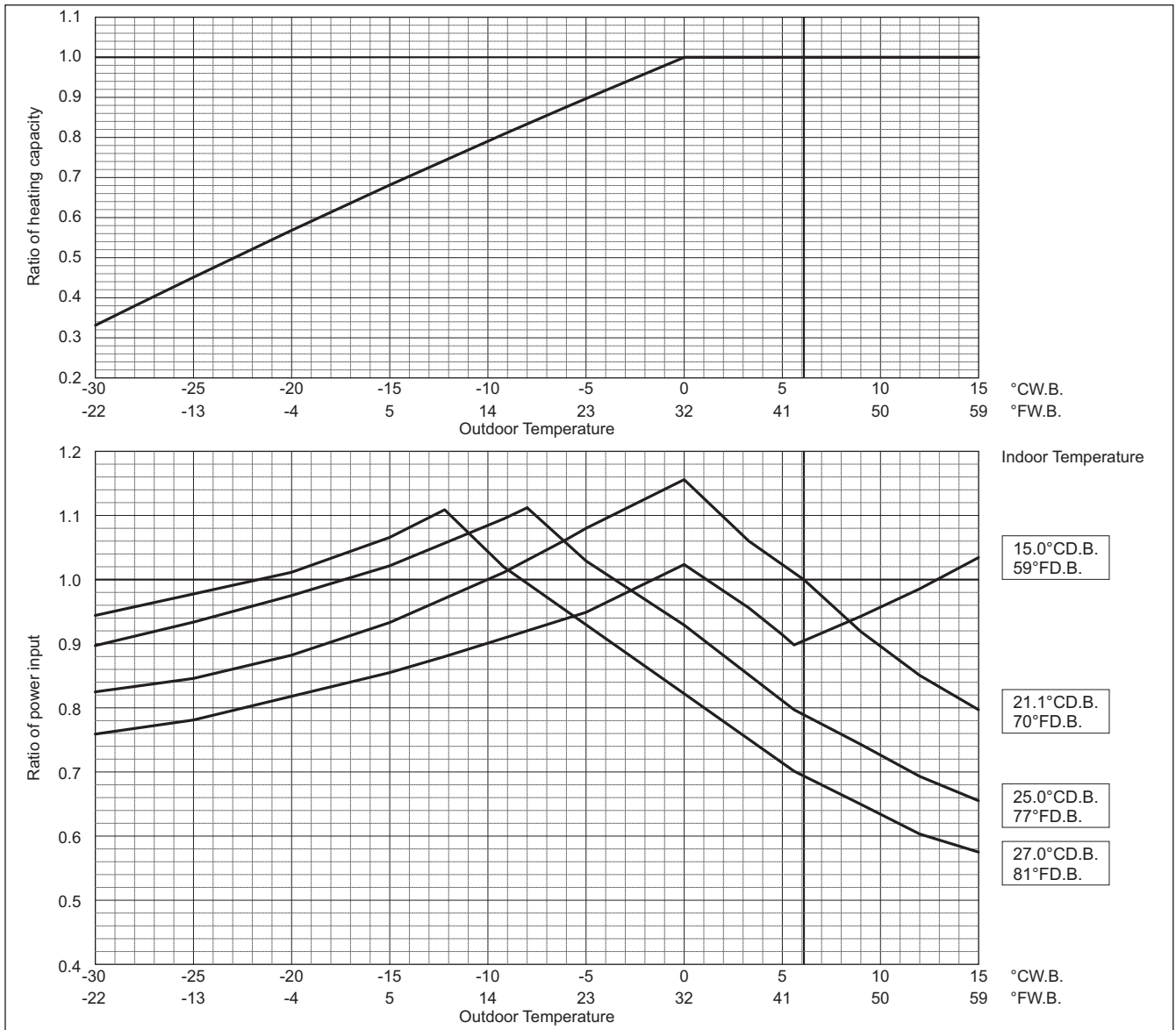

PUHY-HP-T(S)NU-A, Y(S)NU-A

PUHY-HP-T(S)NU-A, Y(S)NU-A

PUHY-		HP192TSNU/YSNU	
		Non-Ducted	Ducted
Nominal cooling capacity	BTU/h	192,000	
	kW	56.3	
	Input kW	13.79	

**Indoor unit temperature correction**  
To be used to correct indoor unit capacity only

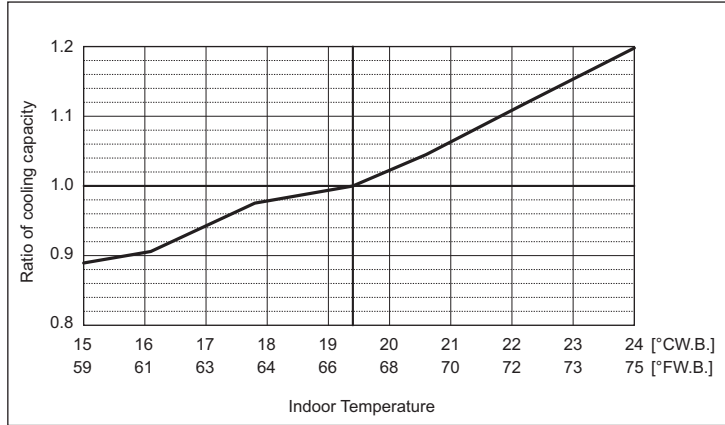

**Outdoor unit temperature correction**

To be used to correct outdoor unit only  
Outdoor unit capacity is NOT affected by the indoor temperature.  
Outdoor unit power input is affected by the indoor and outdoor temperatures. Please consult the sales office for details.

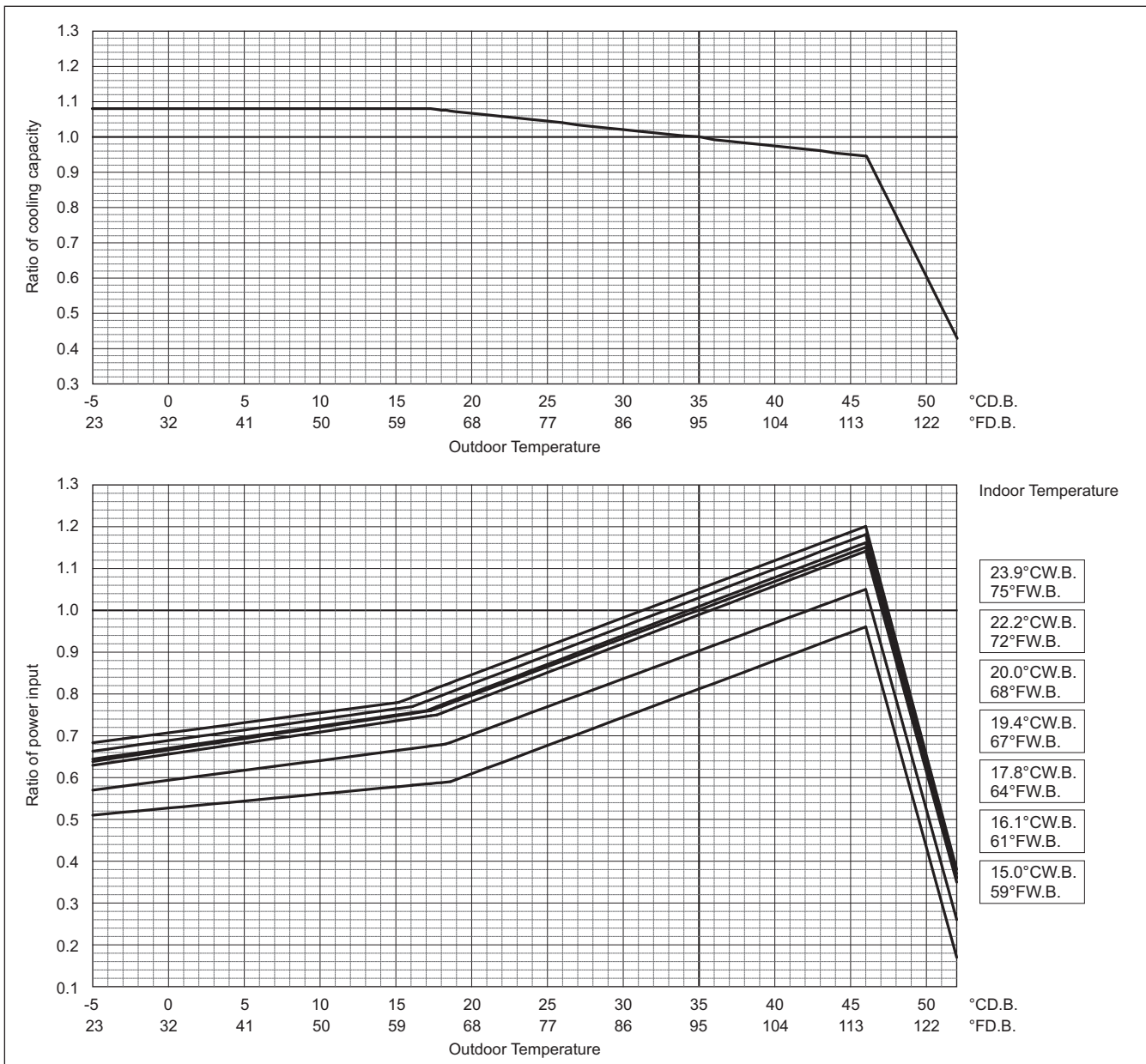



PUHY-		HP192TSNU/YSNU	
		Non-Ducted	Ducted
Nominal Heating capacity	BTU/h	215,000	
	kW	63.0	
	Input kW	15.91	

**Indoor unit temperature correction**

To be used to correct indoor unit capacity only

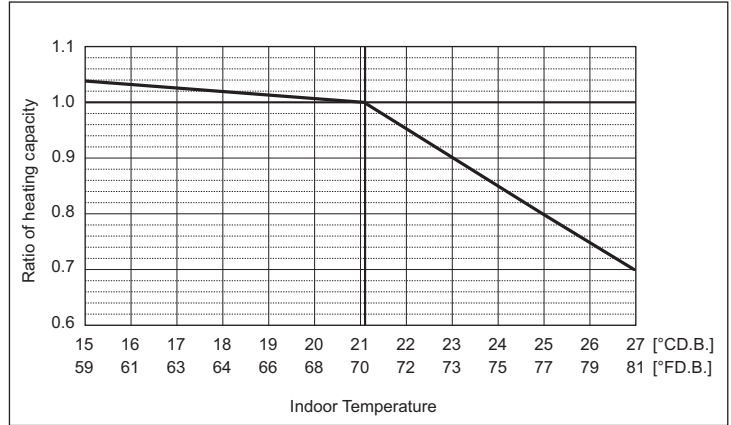

**Outdoor unit temperature correction**

To be used to correct outdoor unit only

Outdoor unit capacity is NOT affected by the indoor temperature.

Outdoor unit power input is affected by the indoor and outdoor temperatures. Please consult the sales office for details.

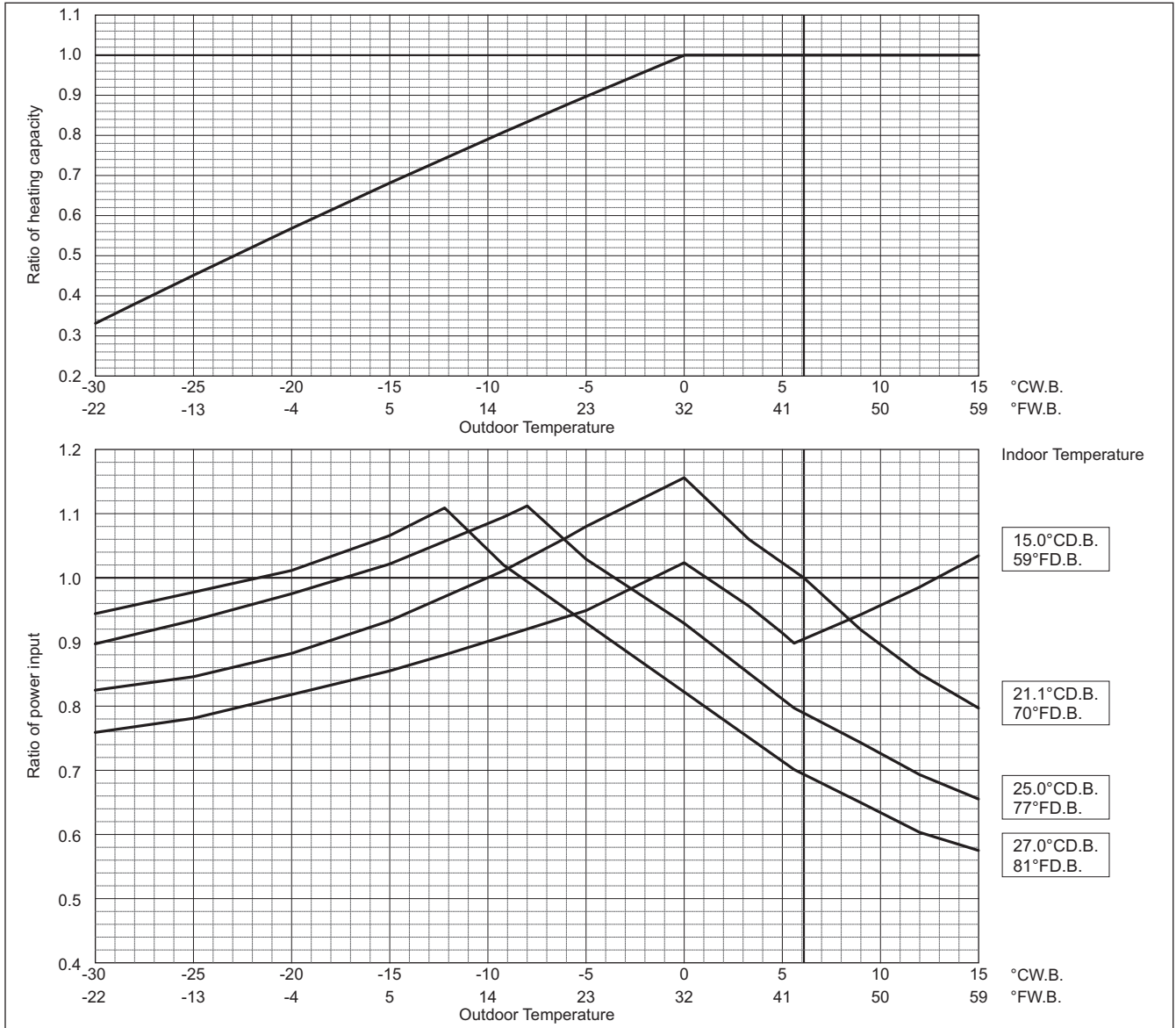

PUHY-HP-T(S)NU-A, Y(S)NU-A

PUHY-HP-T(S)NU-A, Y(S)NU-A

PUHY-		HP240TSNU/YSNU	
		Non-Ducted	Ducted
Nominal cooling capacity	BTU/h	240,000	
	kW	70.3	
	Input kW	19.37	

**Indoor unit temperature correction**  
To be used to correct indoor unit capacity only

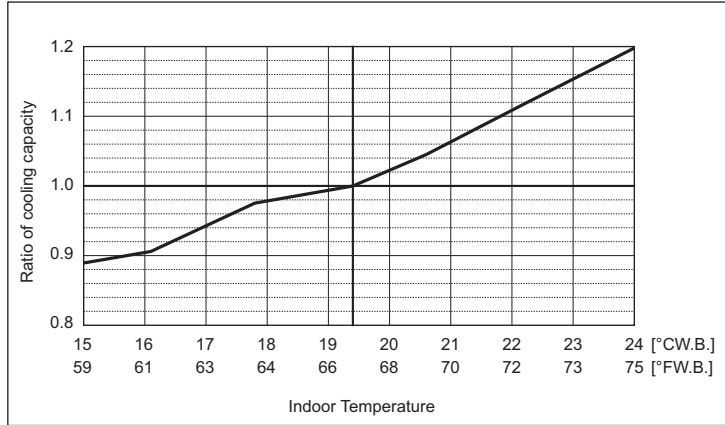

**Outdoor unit temperature correction**

To be used to correct outdoor unit only  
Outdoor unit capacity is NOT affected by the indoor temperature.  
Outdoor unit power input is affected by the indoor and outdoor temperatures. Please consult the sales office for details.

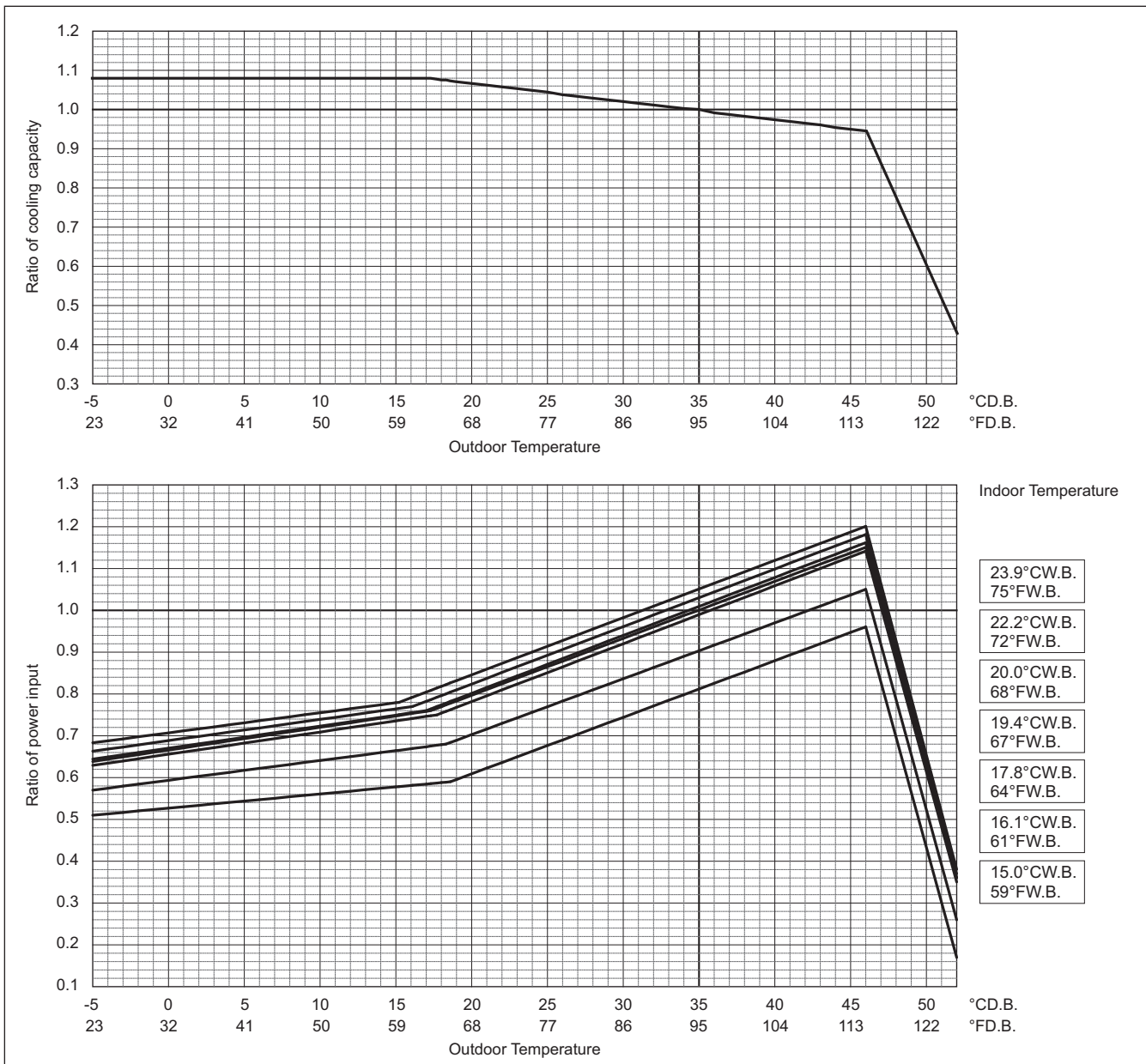



PUHY-		HP240TSNU/YSNU	
		Non-Ducted	Ducted
Nominal Heating capacity	BTU/h	270,000	
	kW	79.1	
	Input kW	21.38	

**Indoor unit temperature correction**  
To be used to correct indoor unit capacity only

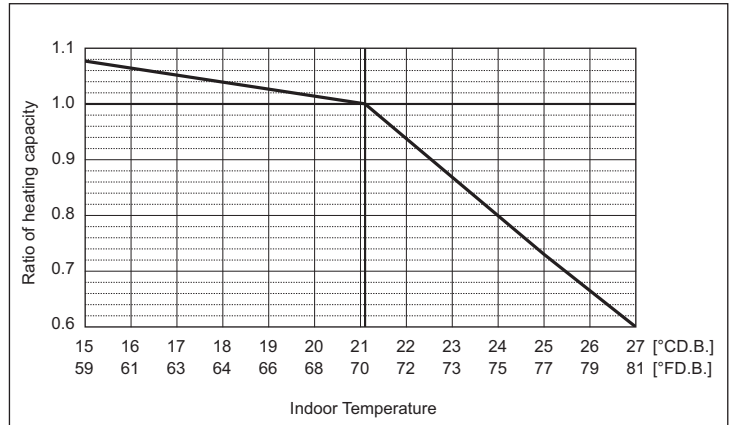

**Outdoor unit temperature correction**

To be used to correct outdoor unit only  
Outdoor unit capacity is NOT affected by the indoor temperature.  
Outdoor unit power input is affected by the indoor and outdoor temperatures. Please consult the sales office for details.

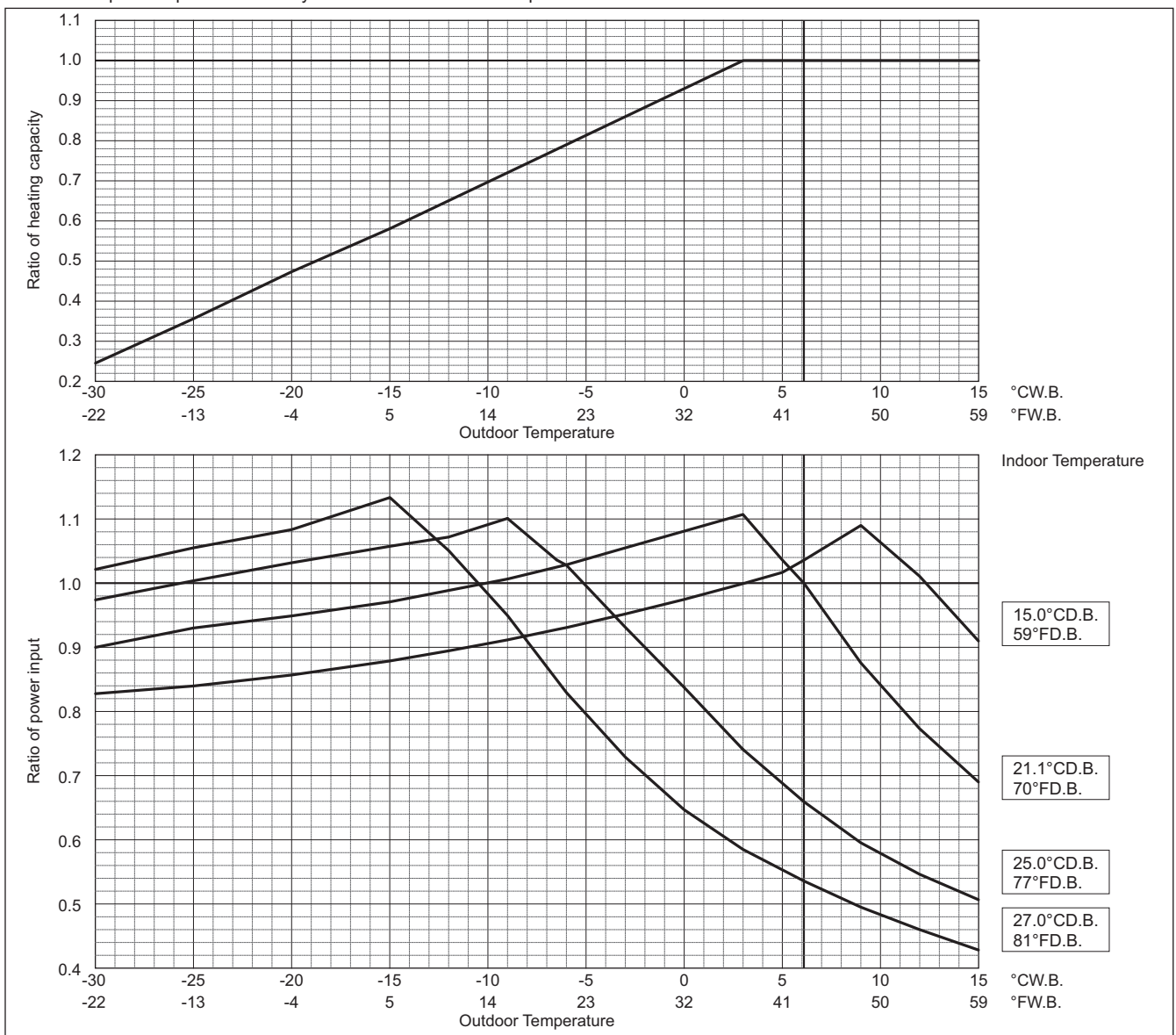

PUHY-HP-T(S)NU-A, Y(S)NU-A

**Correction by temperature (High Heating Performance Mode)**

CITY MULTI could have various capacities at different designing temperatures. Using the nominal cooling/heating capacity values and the ratios below, the capacity can be found for various temperatures.

To select high heating performance mode, DipSW 6-2 and SW4 (968) must be set to ON. (In the low ambient temperature, heating capacity and power input become higher than those under standard mode.)

PUHY-		HP72TNU/YNU	
		Non-Ducted	Ducted
Nominal cooling capacity	BTU/h	72,000	
	kW	21.1	
Input	kW	5.39	

**Indoor unit temperature correction**

To be used to correct indoor unit capacity only

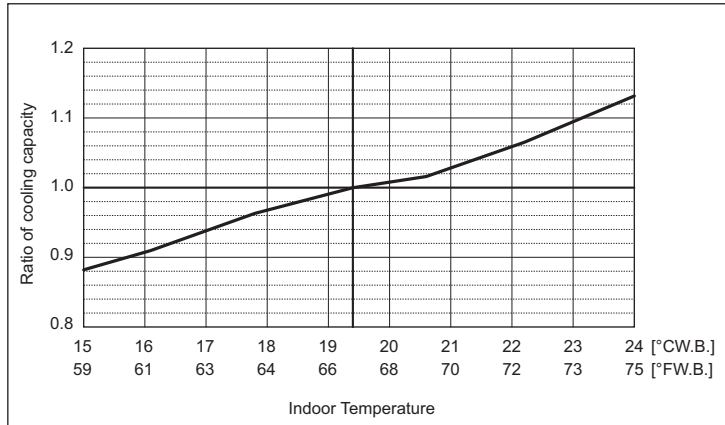

**Outdoor unit temperature correction**

To be used to correct outdoor unit only

Outdoor unit capacity is NOT affected by the indoor temperature.

Outdoor unit power input is affected by the indoor and outdoor temperatures. Please consult the sales office for details.

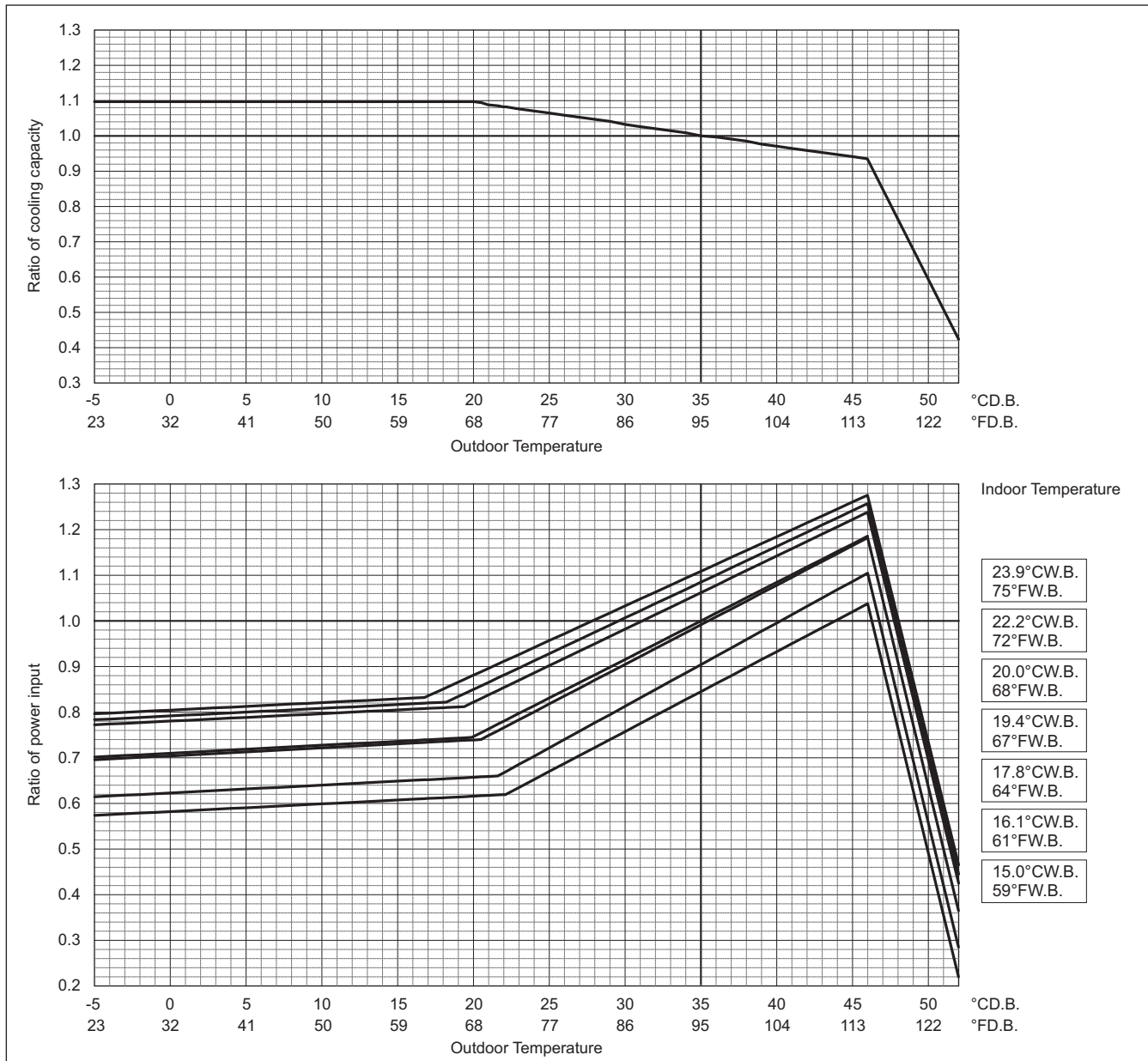

PUHY-HP-T(S)NU-A, Y(S)NU-A

High Heating Performance Mode

PUHY-		HP72TNU/YNU	
		Non-Ducted	Ducted
Nominal Heating capacity	BTU/h	80,000	
	kW	23.4	
	Input kW	5.33	

Indoor unit temperature correction

To be used to correct indoor unit capacity only

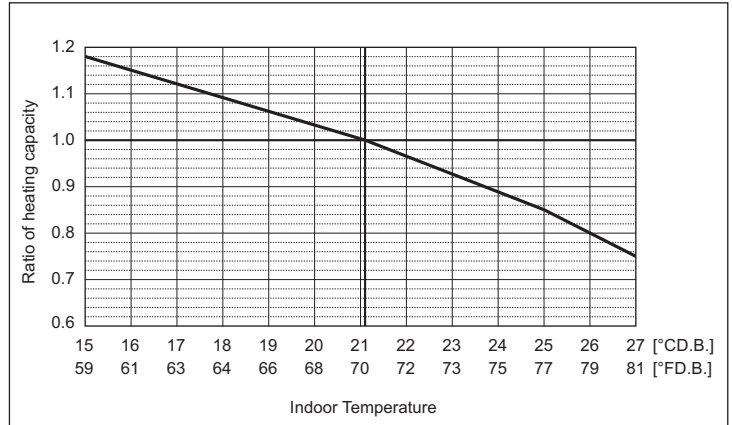

Outdoor unit temperature correction

To be used to correct outdoor unit only

Outdoor unit capacity is NOT affected by the indoor temperature.

Outdoor unit power input is affected by the indoor and outdoor temperatures. Please consult the sales office for details.

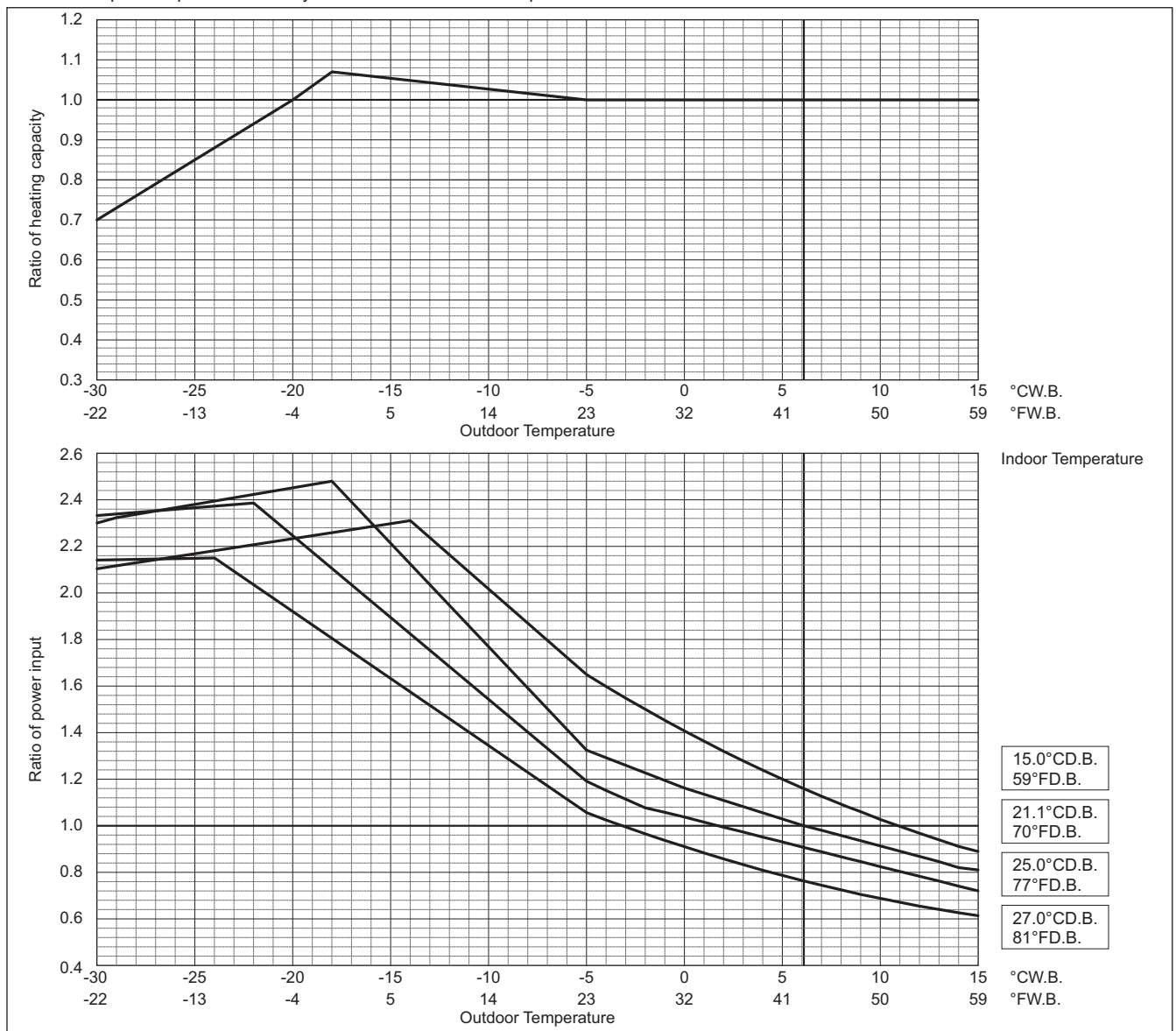

PUHY-HP-T(S)NU-A, Y(S)NU-A

PUHY-HP-T(S)NU-A, Y(S)NU-A

PUHY-		HP96TNU/YNU	
		Non-Ducted	Ducted
Nominal cooling capacity	BTU/h	96,000	
	kW	28.1	
	Input kW	6.23	

**Indoor unit temperature correction**  
To be used to correct indoor unit capacity only

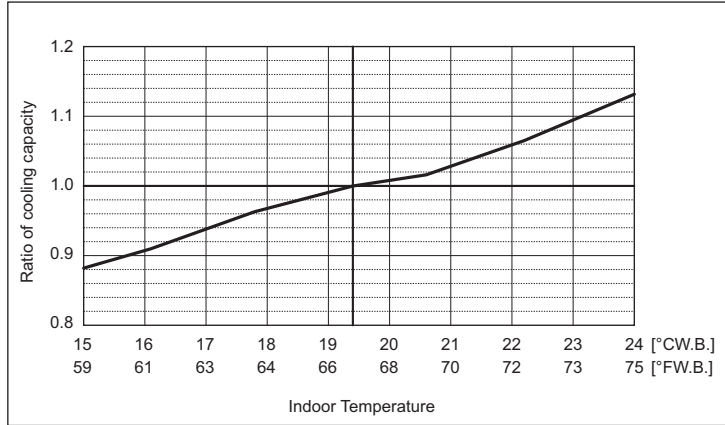

**Outdoor unit temperature correction**

To be used to correct outdoor unit only  
Outdoor unit capacity is NOT affected by the indoor temperature.  
Outdoor unit power input is affected by the indoor and outdoor temperatures. Please consult the sales office for details.

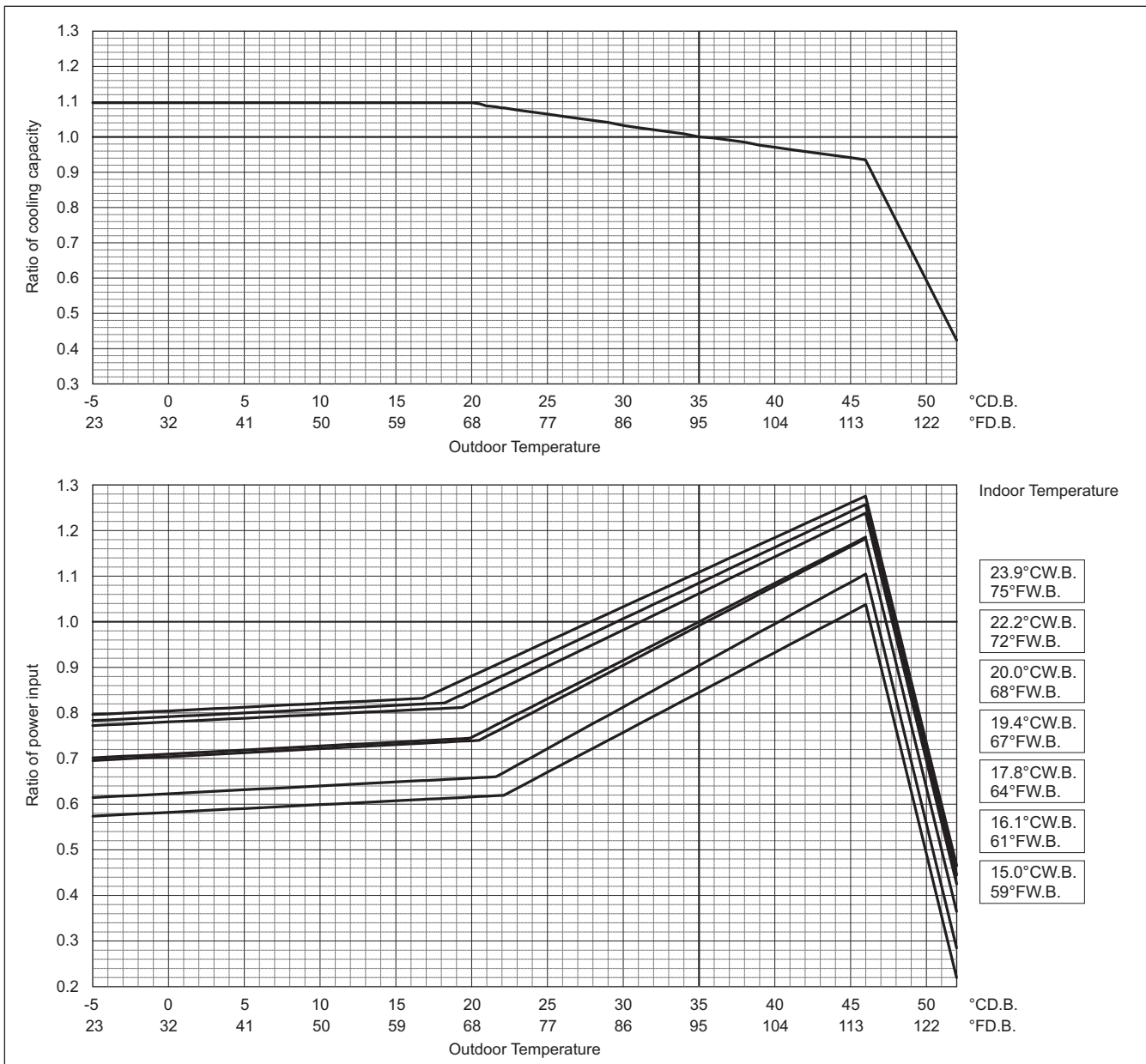

High Heating Performance Mode

PUHY-		HP96TNU/YNU	
		Non-Ducted	Ducted
Nominal Heating capacity	BTU/h	108,000	
	kW	31.7	
	Input kW	7.33	

Indoor unit temperature correction

To be used to correct indoor unit capacity only

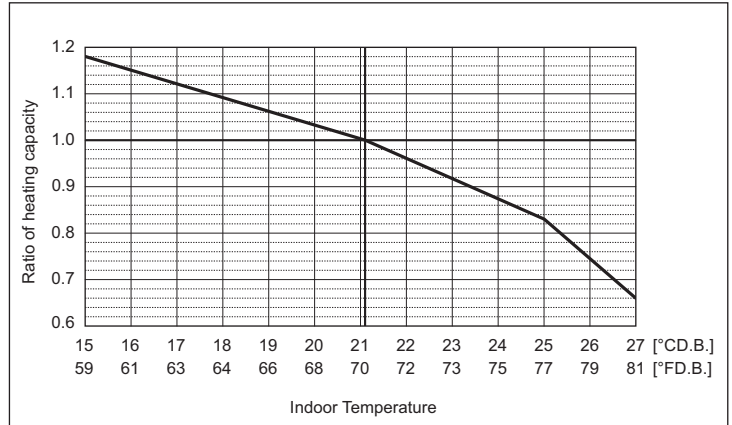

Outdoor unit temperature correction

To be used to correct outdoor unit only

Outdoor unit capacity is NOT affected by the indoor temperature.

Outdoor unit power input is affected by the indoor and outdoor temperatures. Please consult the sales office for details.

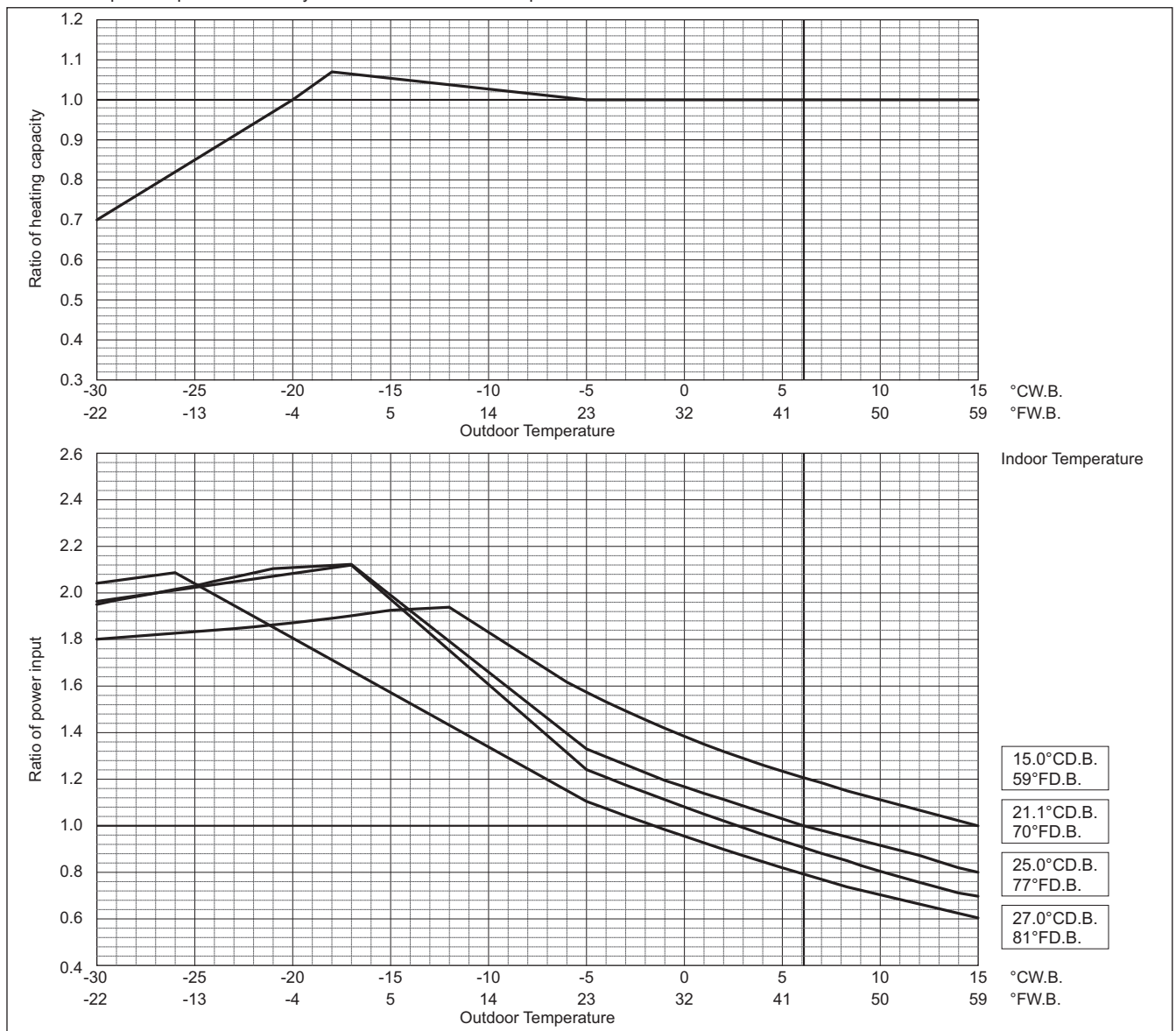

PUHY-HP-T(S)NU-A, Y(S)NU-A



PUHY-HP-T(S)NU-A, Y(S)NU-A

PUHY-	HP120TNU/YNU	
	Non-Ducted	Ducted
Nominal cooling capacity	BTU/h	120,000
	kW	35.2
	Input kW	8.53

**Indoor unit temperature correction**  
To be used to correct indoor unit capacity only

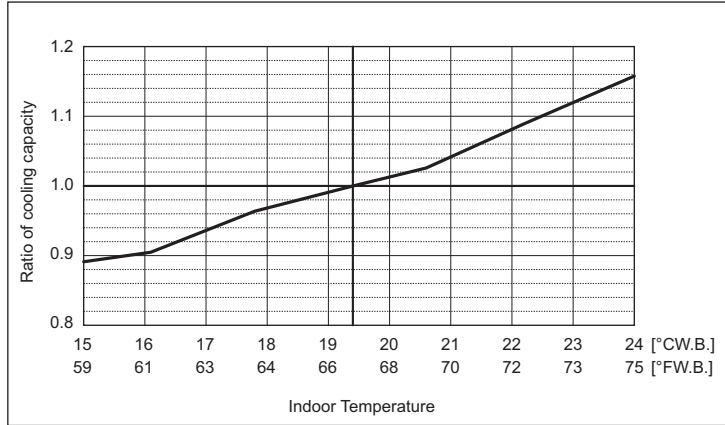

**Outdoor unit temperature correction**

To be used to correct outdoor unit only  
Outdoor unit capacity is NOT affected by the indoor temperature.  
Outdoor unit power input is affected by the indoor and outdoor temperatures. Please consult the sales office for details.

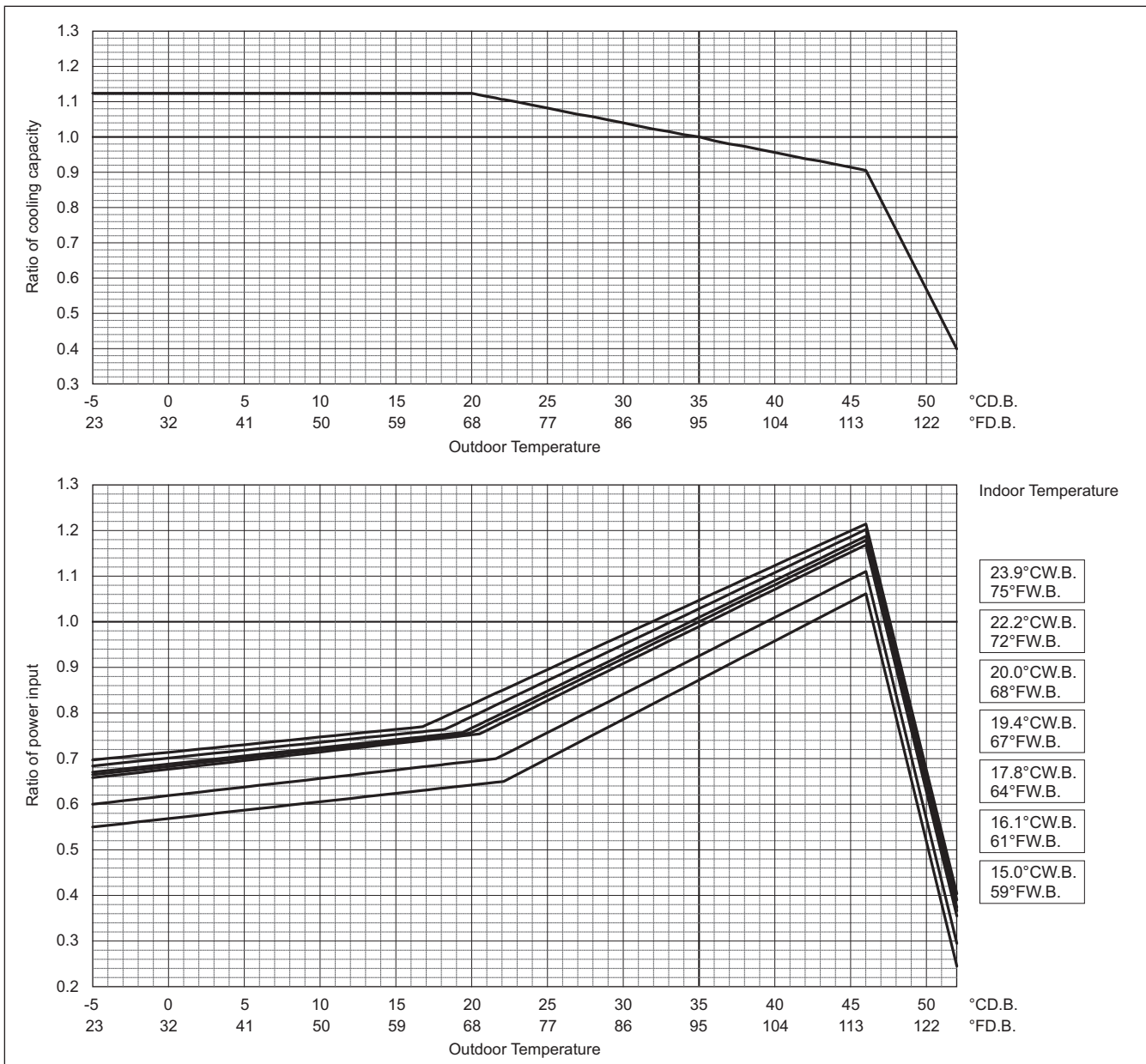

High Heating Performance Mode

PUHY-		HP120TNU/YNU	
		Non-Ducted	Ducted
Nominal Heating capacity	BTU/h	135,000	
	kW	39.6	
	Input kW	9.63	

Indoor unit temperature correction

To be used to correct indoor unit capacity only

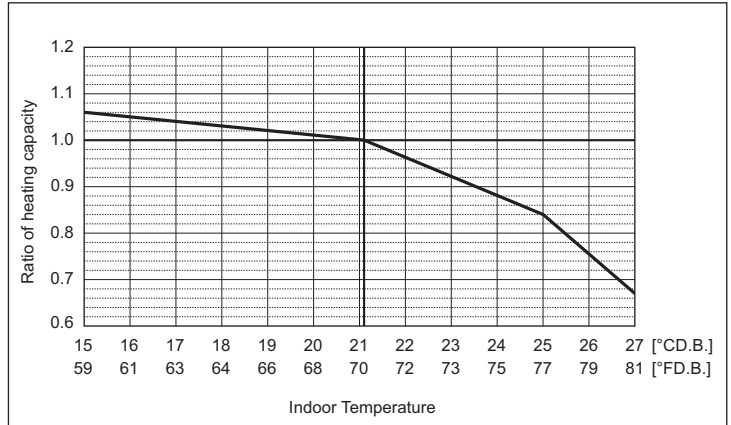

Outdoor unit temperature correction

To be used to correct outdoor unit only

Outdoor unit capacity is NOT affected by the indoor temperature.

Outdoor unit power input is affected by the indoor and outdoor temperatures. Please consult the sales office for details.

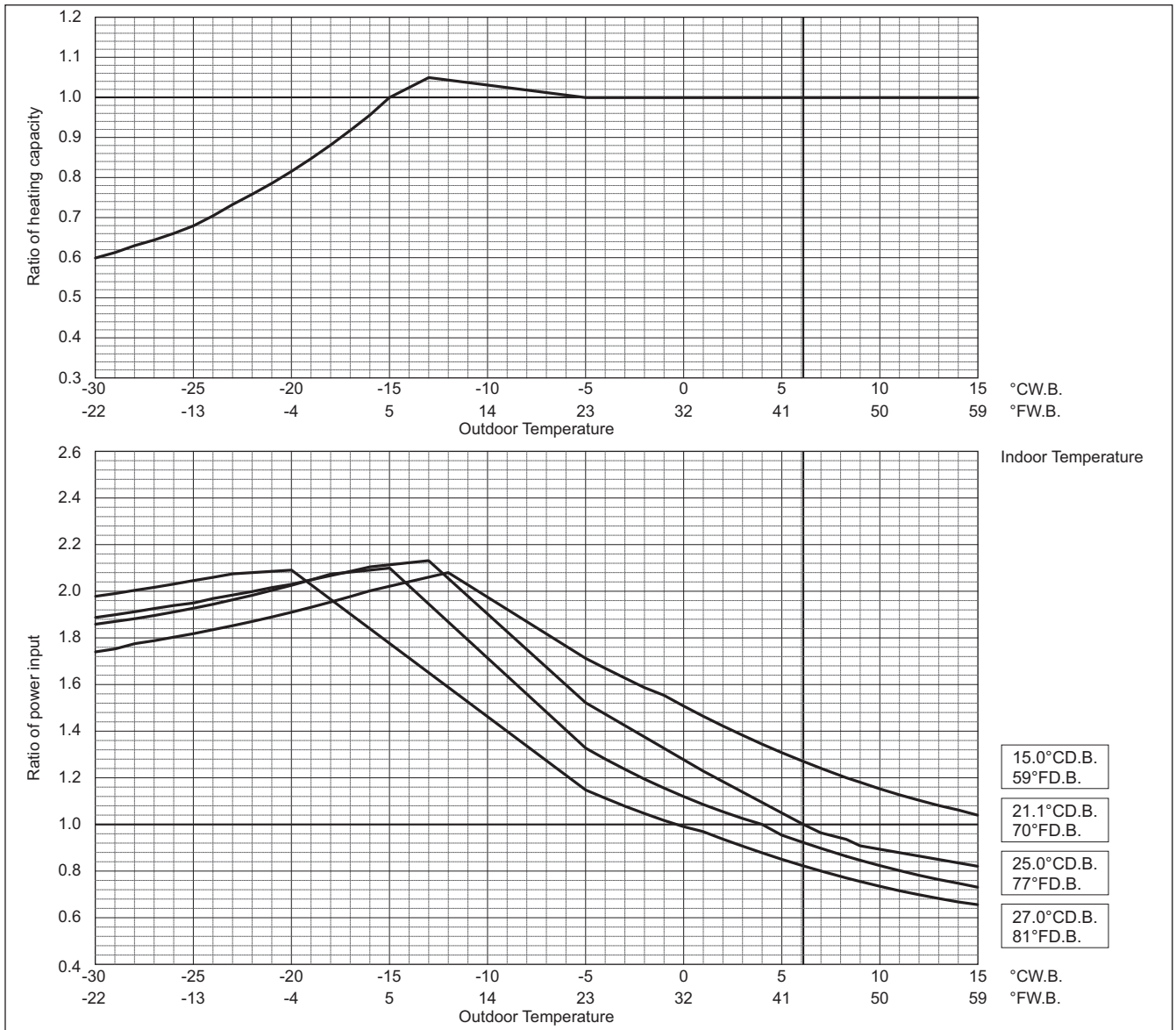

PUHY-HP-T(S)NU-A, Y(S)NU-A



PUHY-HP-T(S)NU-A, Y(S)NU-A

PUHY-		HP144TSNU/YSNU	
		Non-Ducted	Ducted
Nominal cooling capacity	BTU/h	144,000	
	kW	42.2	
	Input kW	12.20	

**Indoor unit temperature correction**  
To be used to correct indoor unit capacity only

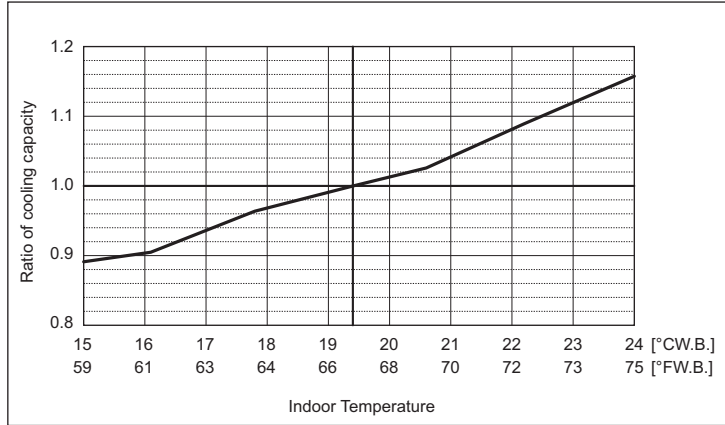

**Outdoor unit temperature correction**

To be used to correct outdoor unit only  
Outdoor unit capacity is NOT affected by the indoor temperature.  
Outdoor unit power input is affected by the indoor and outdoor temperatures. Please consult the sales office for details.

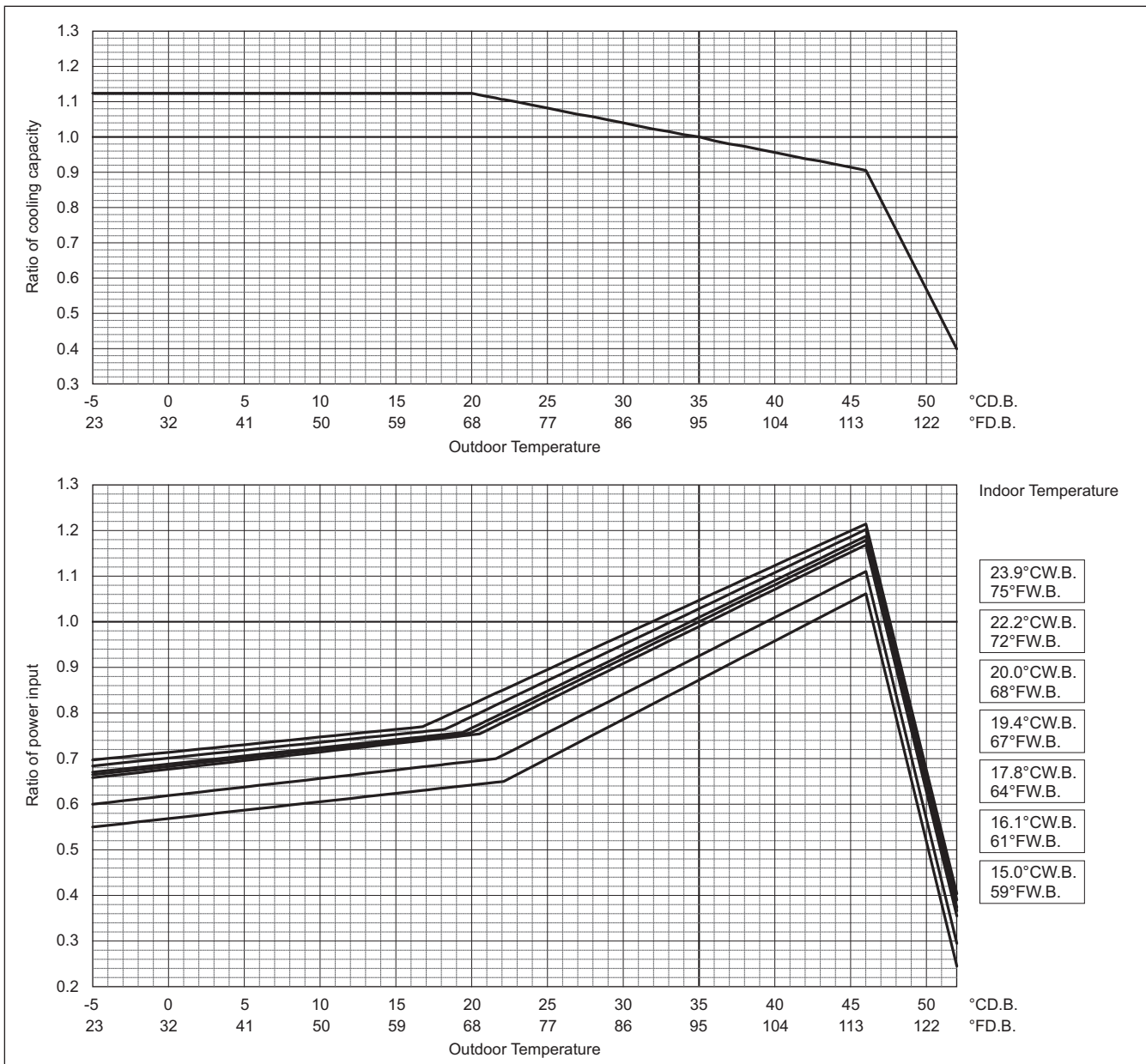

High Heating Performance Mode

PUHY-		HP144TSNU/YSNU	
		Non-Ducted	Ducted
Nominal Heating capacity	BTU/h	160,000	
	kW	46.9	
	Input kW	11.70	

Indoor unit temperature correction

To be used to correct indoor unit capacity only

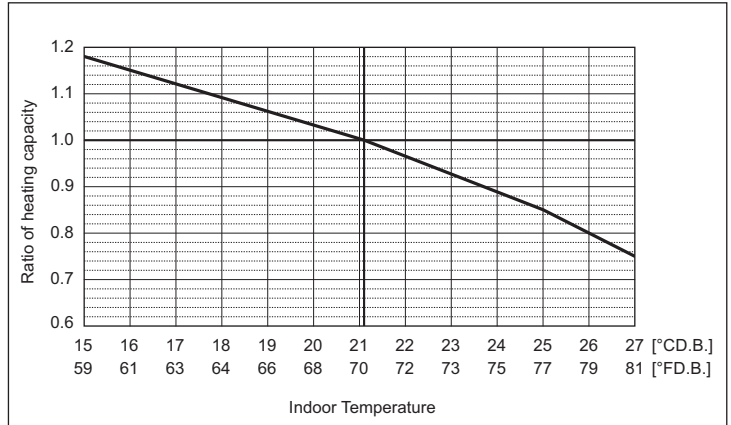

Outdoor unit temperature correction

To be used to correct outdoor unit only

Outdoor unit capacity is NOT affected by the indoor temperature.

Outdoor unit power input is affected by the indoor and outdoor temperatures. Please consult the sales office for details.

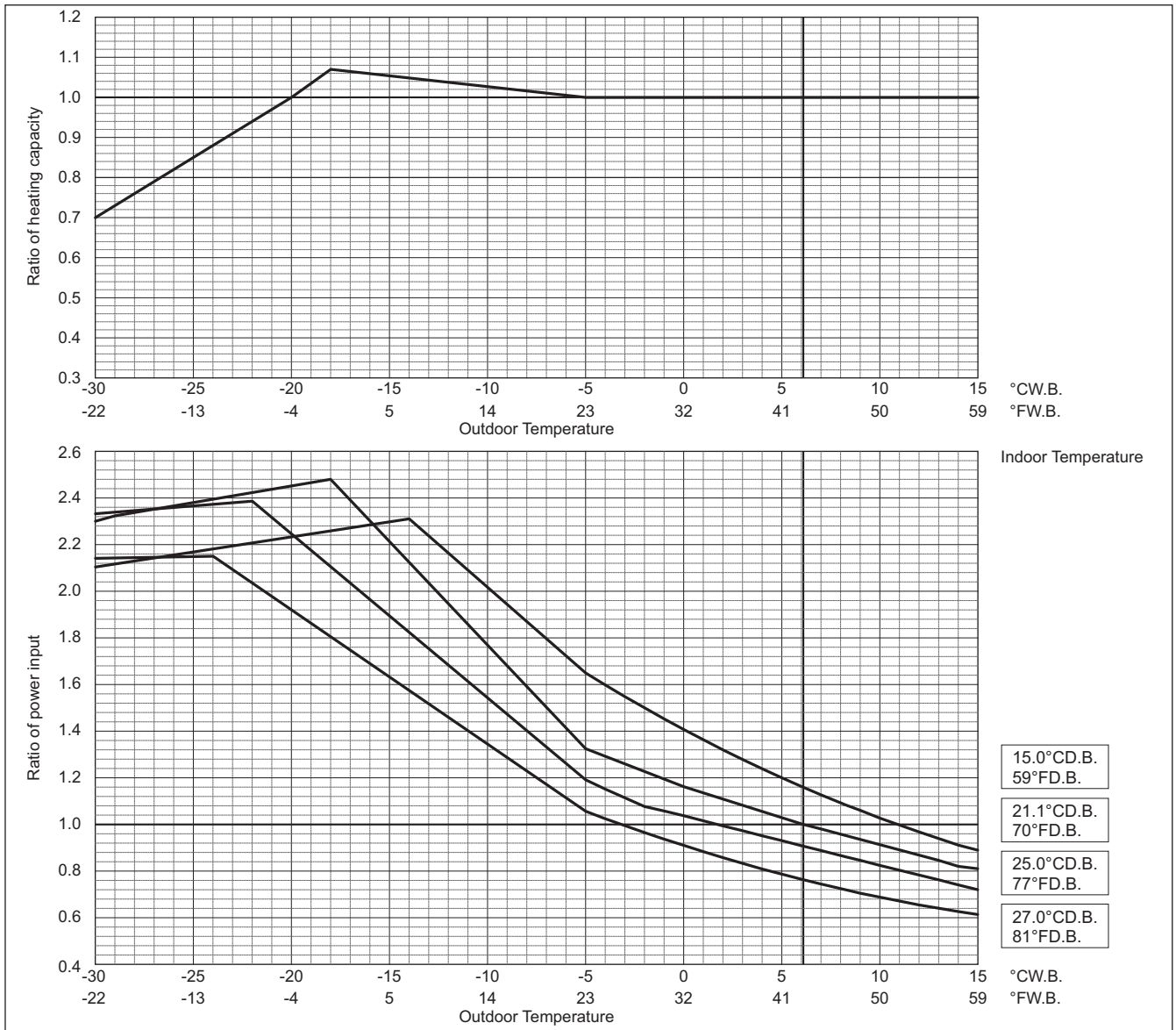

PUHY-HP-T(S)NU-A, Y(S)NU-A

PUHY-HP-T(S)NU-A, Y(S)NU-A

PUHY-		HP192TSNU/YSNU	
		Non-Ducted	Ducted
Nominal cooling capacity	BTU/h	192,000	
	kW	56.3	
	Input kW	13.79	

**Indoor unit temperature correction**  
To be used to correct indoor unit capacity only

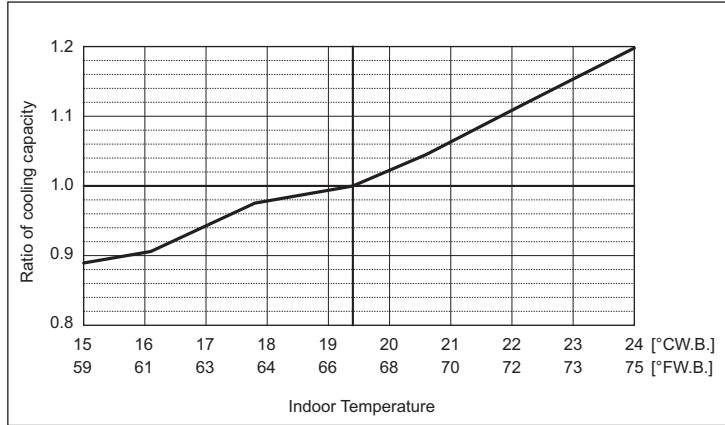

**Outdoor unit temperature correction**

To be used to correct outdoor unit only  
Outdoor unit capacity is NOT affected by the indoor temperature.  
Outdoor unit power input is affected by the indoor and outdoor temperatures. Please consult the sales office for details.

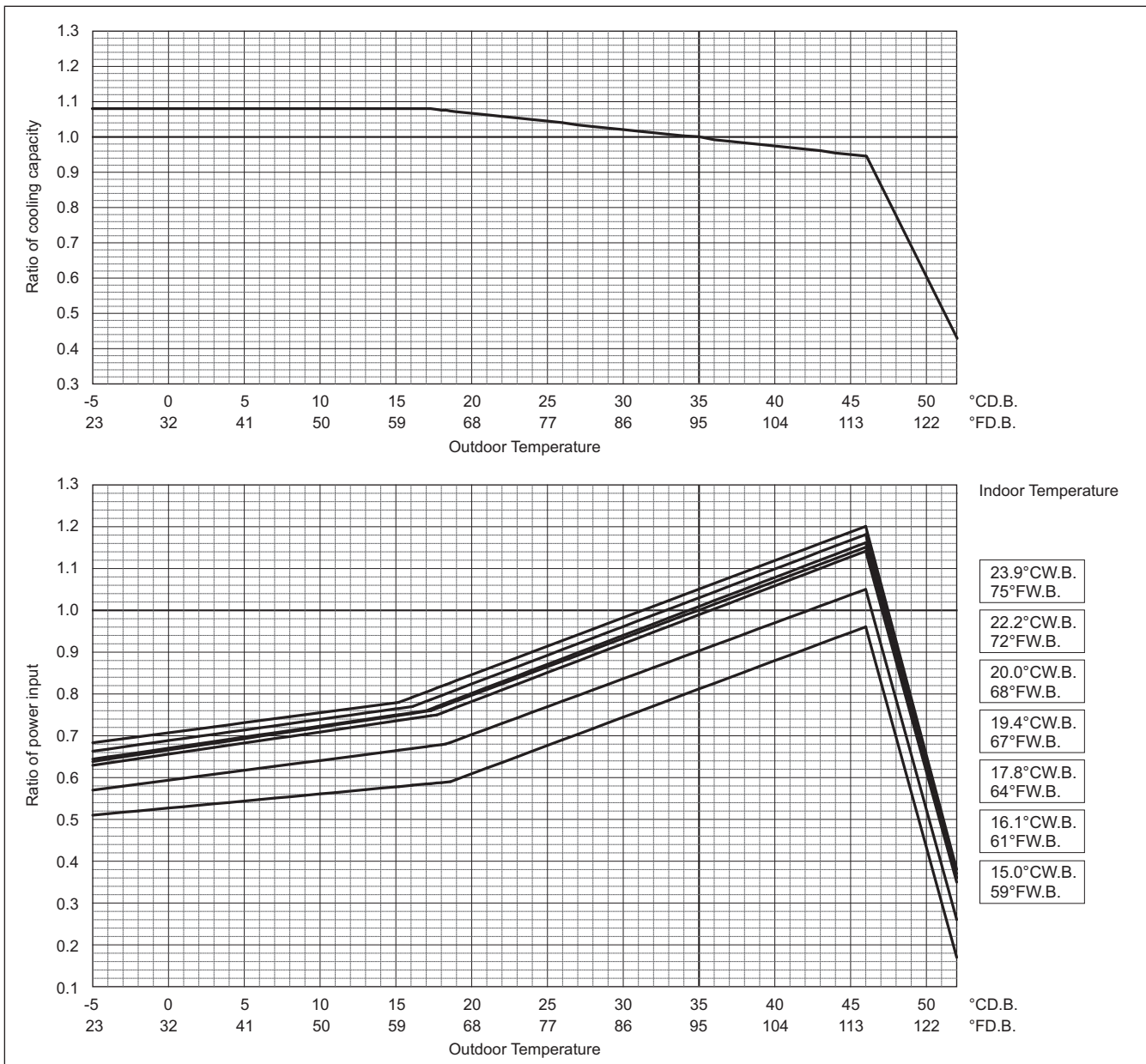

High Heating Performance Mode

PUHY-		HP192TSNU/YSNU	
		Non-Ducted	Ducted
Nominal Heating capacity	BTU/h	215,000	
	kW	63.0	
	Input kW	15.91	

Indoor unit temperature correction

To be used to correct indoor unit capacity only

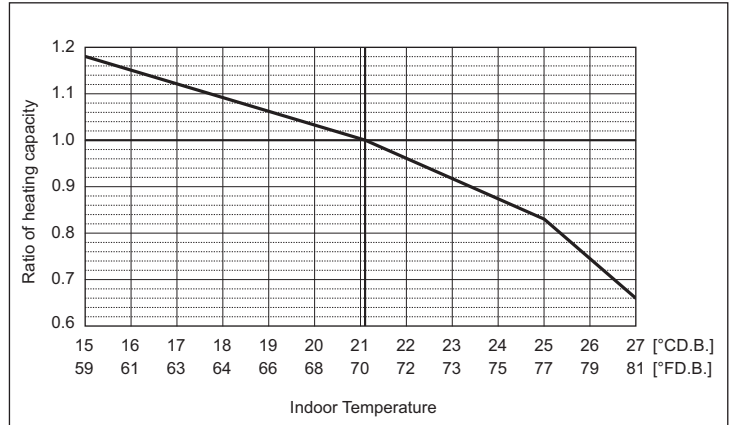

Outdoor unit temperature correction

To be used to correct outdoor unit only

Outdoor unit capacity is NOT affected by the indoor temperature.

Outdoor unit power input is affected by the indoor and outdoor temperatures. Please consult the sales office for details.

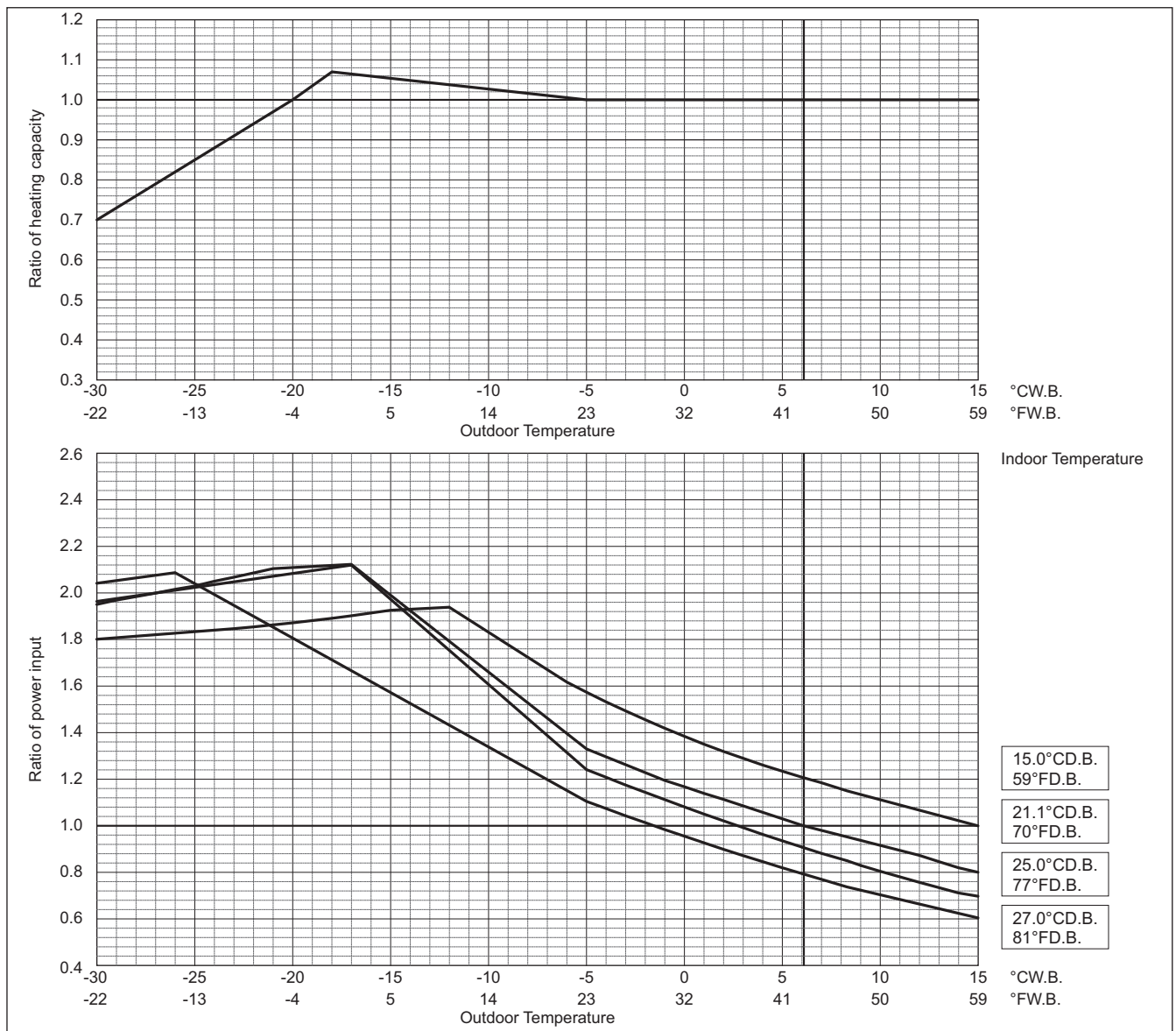

PUHY-HP-T(S)NU-A, Y(S)NU-A

PUHY-		HP240TSNU/YSNU	
		Non-Ducted	Ducted
Nominal cooling capacity	BTU/h	240,000	
	kW	70.3	
	Input kW	19.37	

**Indoor unit temperature correction**  
To be used to correct indoor unit capacity only

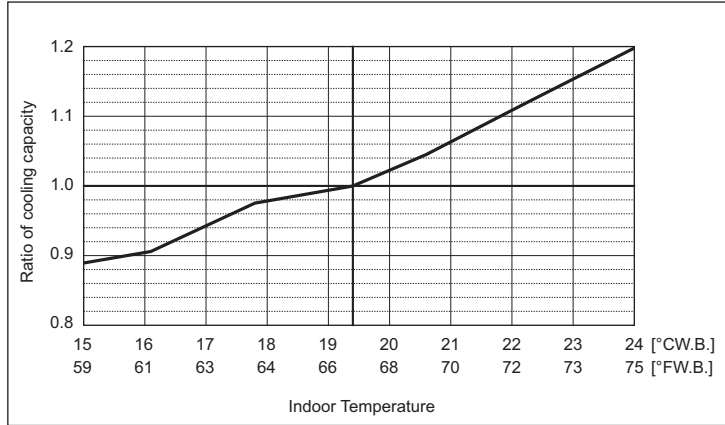

**Outdoor unit temperature correction**

To be used to correct outdoor unit only  
Outdoor unit capacity is NOT affected by the indoor temperature.  
Outdoor unit power input is affected by the indoor and outdoor temperatures. Please consult the sales office for details.

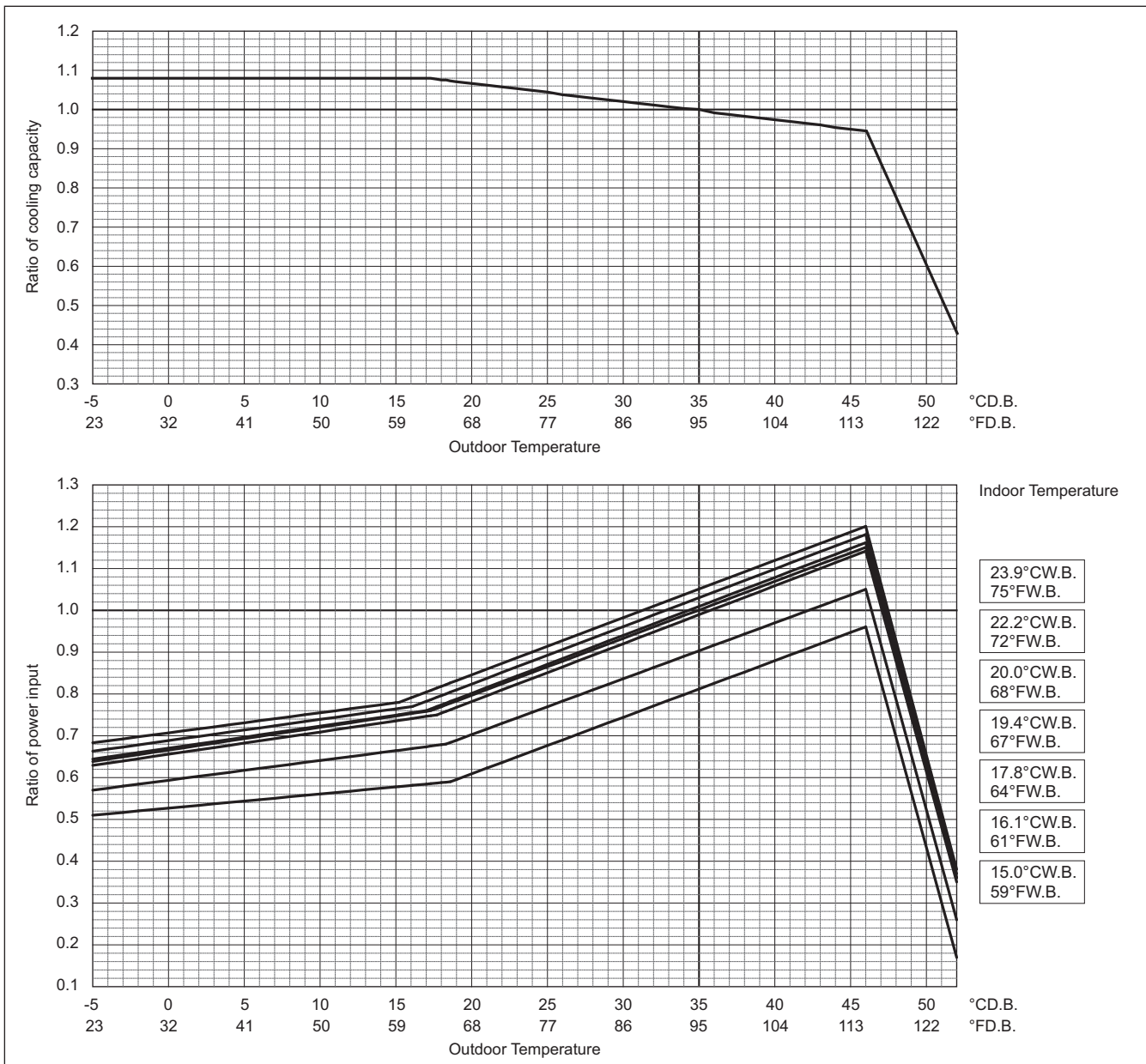



High Heating Performance Mode

PUHY-		HP240TSNU/YSNU	
		Non-Ducted	Ducted
Nominal Heating capacity	BTU/h	270,000	
	kW	79.1	
	Input kW	21.38	

Indoor unit temperature correction

To be used to correct indoor unit capacity only

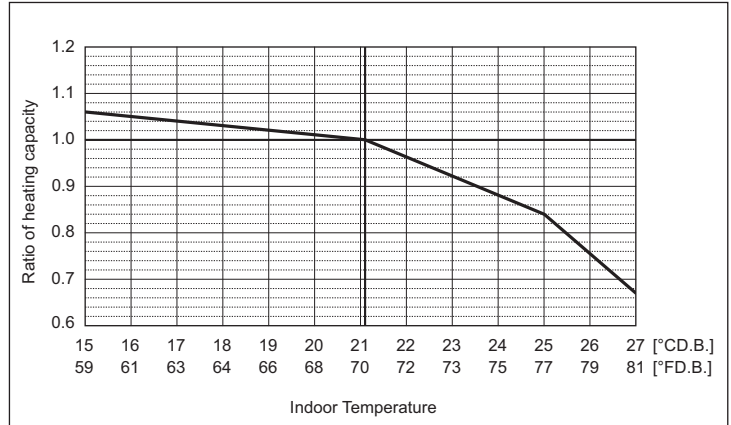

Outdoor unit temperature correction

To be used to correct outdoor unit only

Outdoor unit capacity is NOT affected by the indoor temperature.

Outdoor unit power input is affected by the indoor and outdoor temperatures. Please consult the sales office for details.

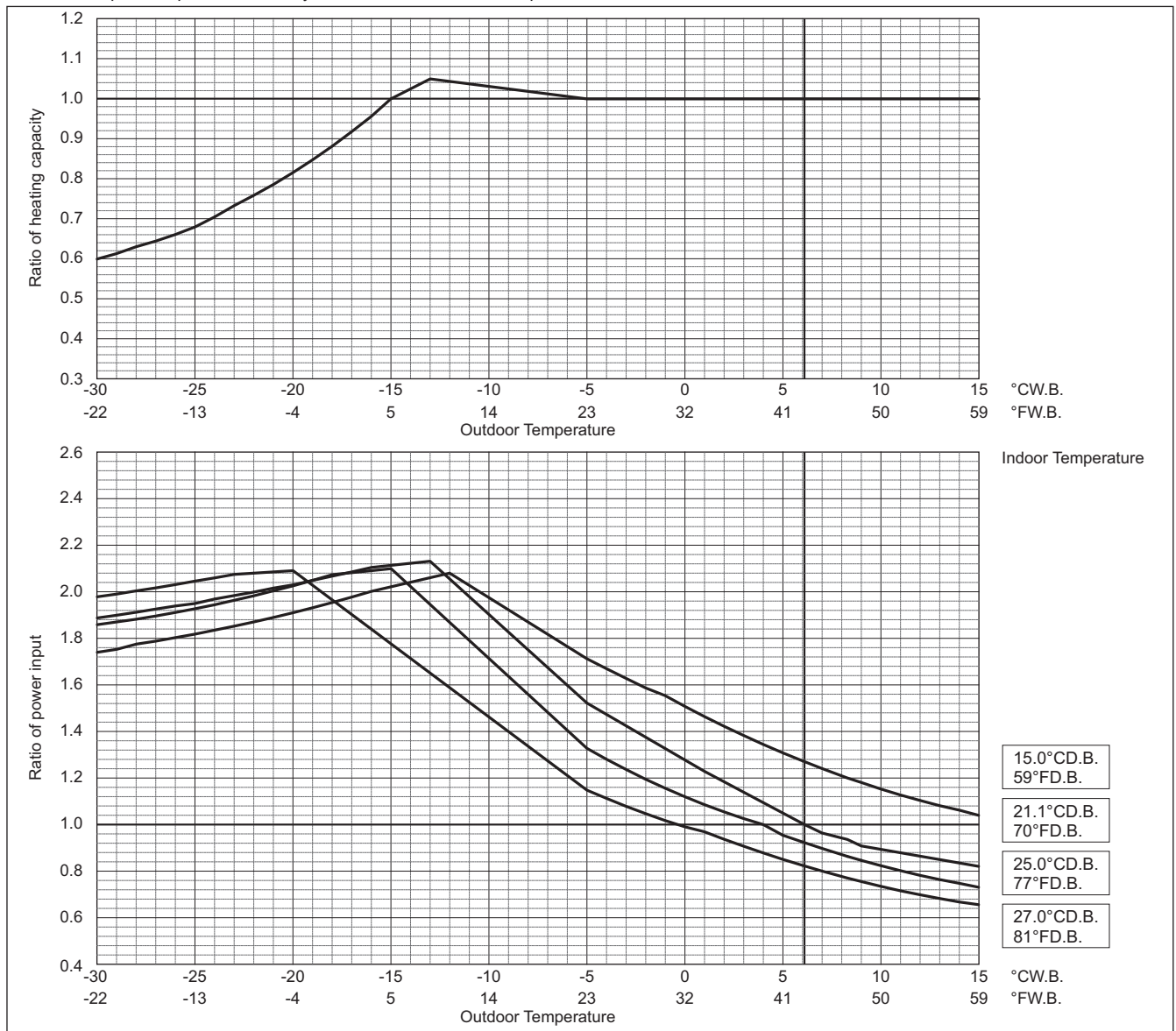

PUHY-HP-T(S)NU-A, Y(S)NU-A

8-3. Correction by total indoor

CITY MULTI system has different capacities and inputs when many combinations of indoor units with different total capacities are connected. Using following tables, the maximum capacity can be found to ensure the system is installed with enough capacity for a particular application.

PUHY-HP-T(S)NU-A, Y(S)NU-A

PUHY-		HP72TNU/YNU	
		Non-Ducted	Ducted
Nominal cooling capacity	BTU/h	72,000	
	kW	21.1	
	Input kW	5.39	

PUHY-		HP72TNU/YNU	
		Non-Ducted	Ducted
Nominal Heating capacity	BTU/h	80,000	
	kW	23.4	
	Input kW	5.33	

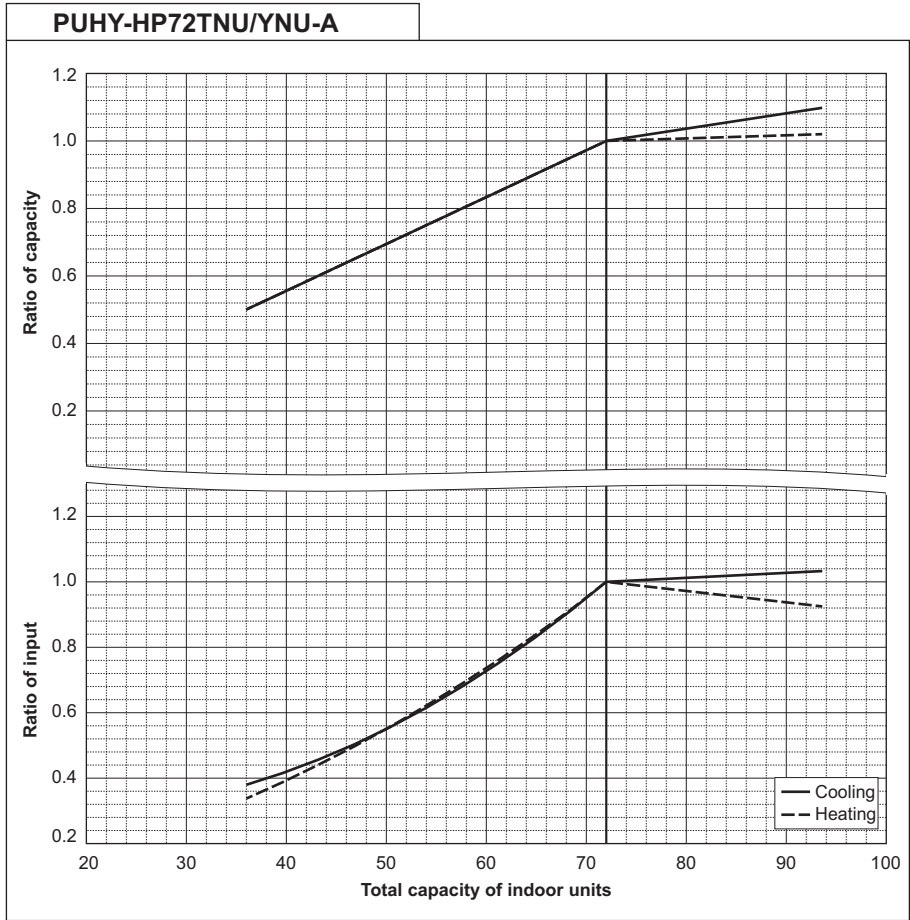

PUHY-		HP96TNU/YNU	
		Non-Ducted	Ducted
Nominal cooling capacity	BTU/h	96,000	
	kW	28.1	
	Input kW	6.23	

PUHY-		HP96TNU/YNU	
		Non-Ducted	Ducted
Nominal Heating capacity	BTU/h	108,000	
	kW	31.7	
	Input kW	7.33	

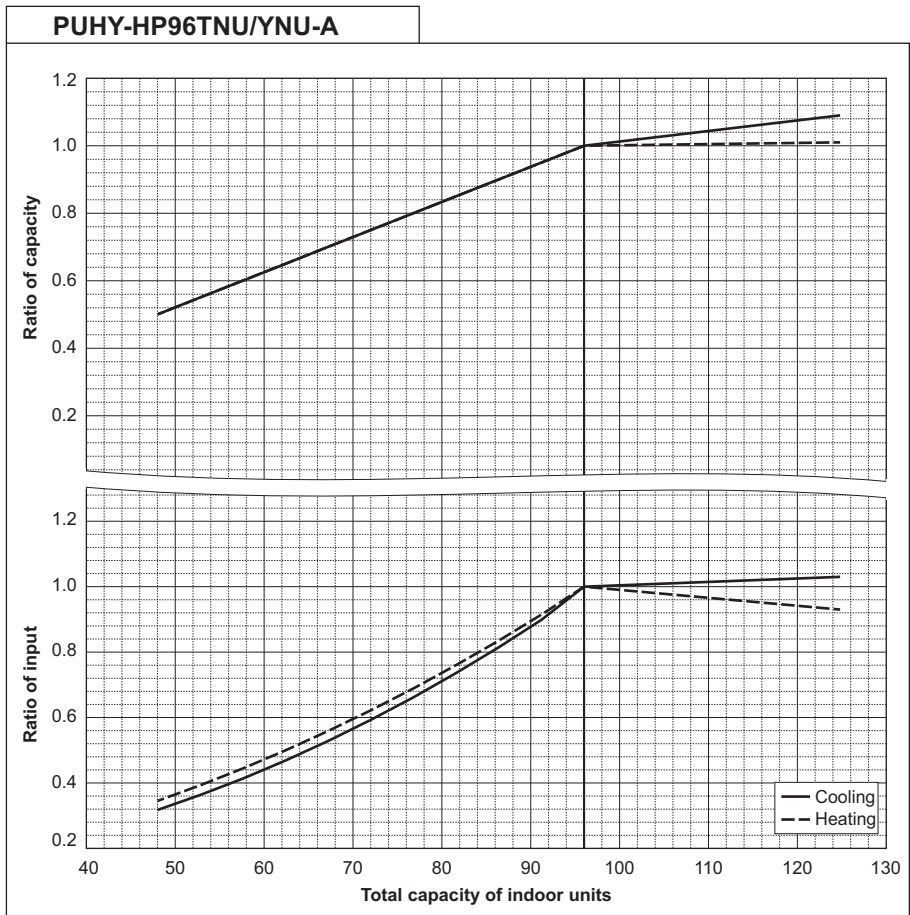



PUHY-		HP120TNU/YNU	
		Non-Ducted	Ducted
Nominal cooling capacity	BTU/h	120,000	
	kW	35.2	
	Input kW	8.53	

PUHY-		HP120TNU/YNU	
		Non-Ducted	Ducted
Nominal Heating capacity	BTU/h	135,000	
	kW	39.6	
	Input kW	9.63	

PUHY-HP120TNU/YNU-A

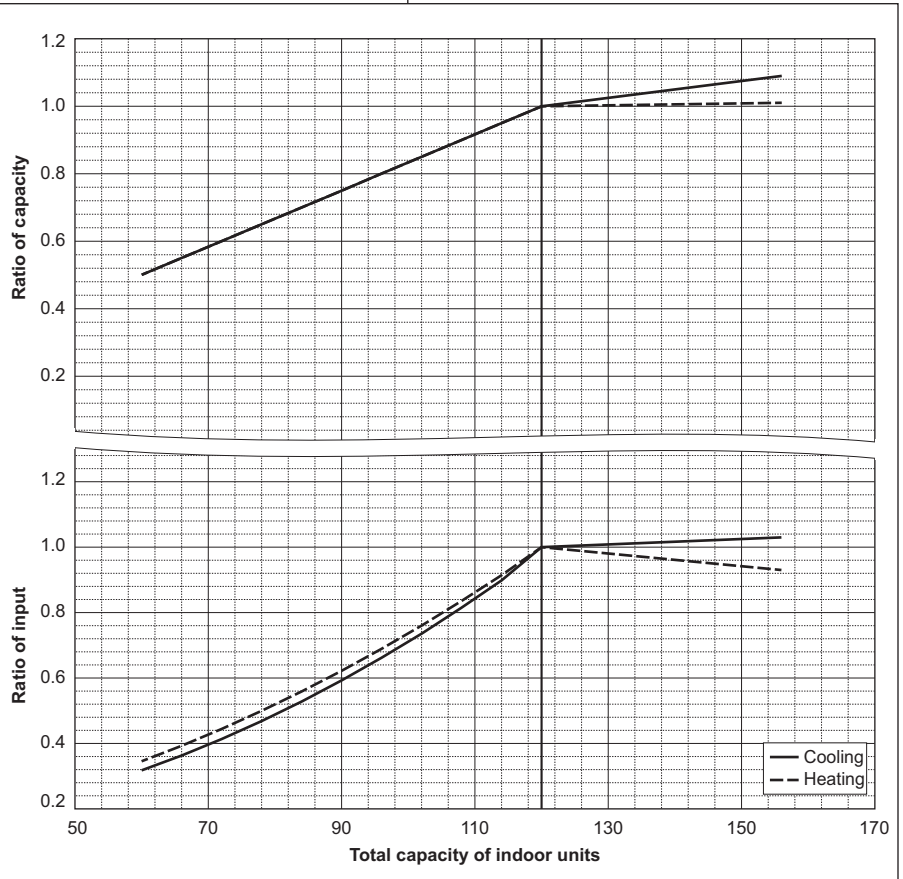

PUHY-		HP144TSNU/YSNU	
		Non-Ducted	Ducted
Nominal cooling capacity	BTU/h	144,000	
	kW	42.2	
	Input kW	12.20	

PUHY-		HP144TSNU/YSNU	
		Non-Ducted	Ducted
Nominal Heating capacity	BTU/h	160,000	
	kW	46.9	
	Input kW	11.70	

PUHY-HP144TSNU/YSNU-A

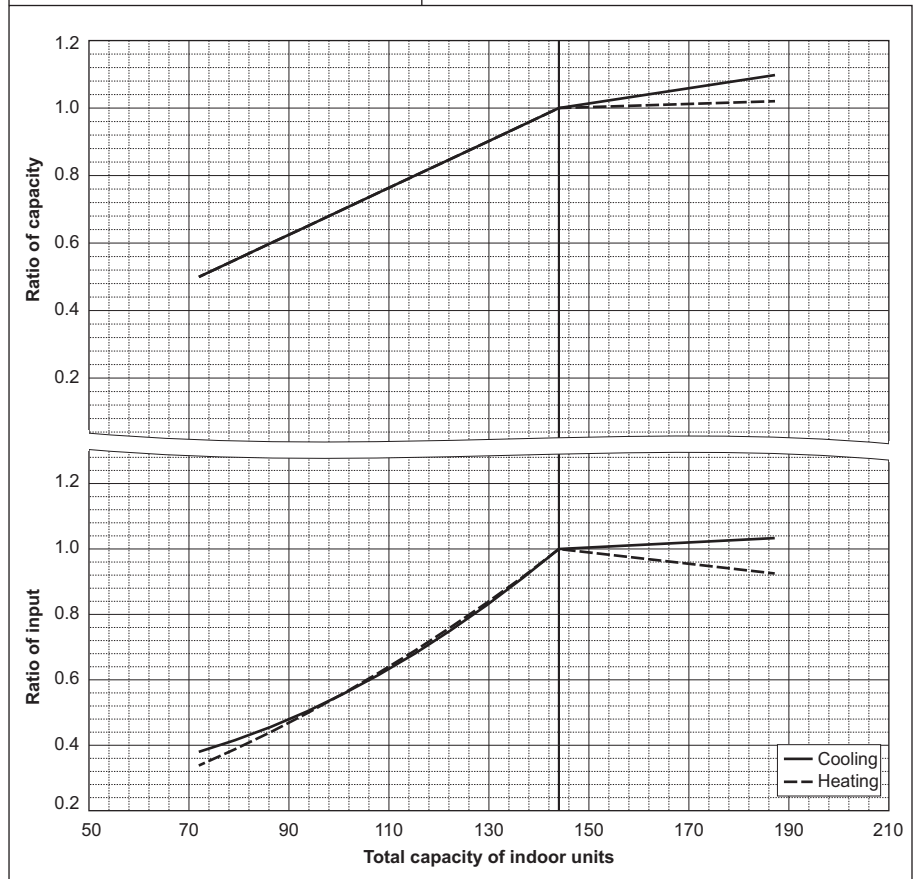

PUHY-HP-T(S)NU-A, Y(S)NU-A

PUHY-HP-T(S)NU-A, Y(S)NU-A

<b>PUHY-</b>		<b>HP192TSNU/YSNU</b>	
		Non-Ducted	Ducted
Nominal cooling capacity	BTU/h	192,000	
	kW	56.3	
	Input kW	13.79	

<b>PUHY-</b>		<b>HP192TSNU/YSNU</b>	
		Non-Ducted	Ducted
Nominal Heating capacity	BTU/h	215,000	
	kW	63.0	
	Input kW	15.91	

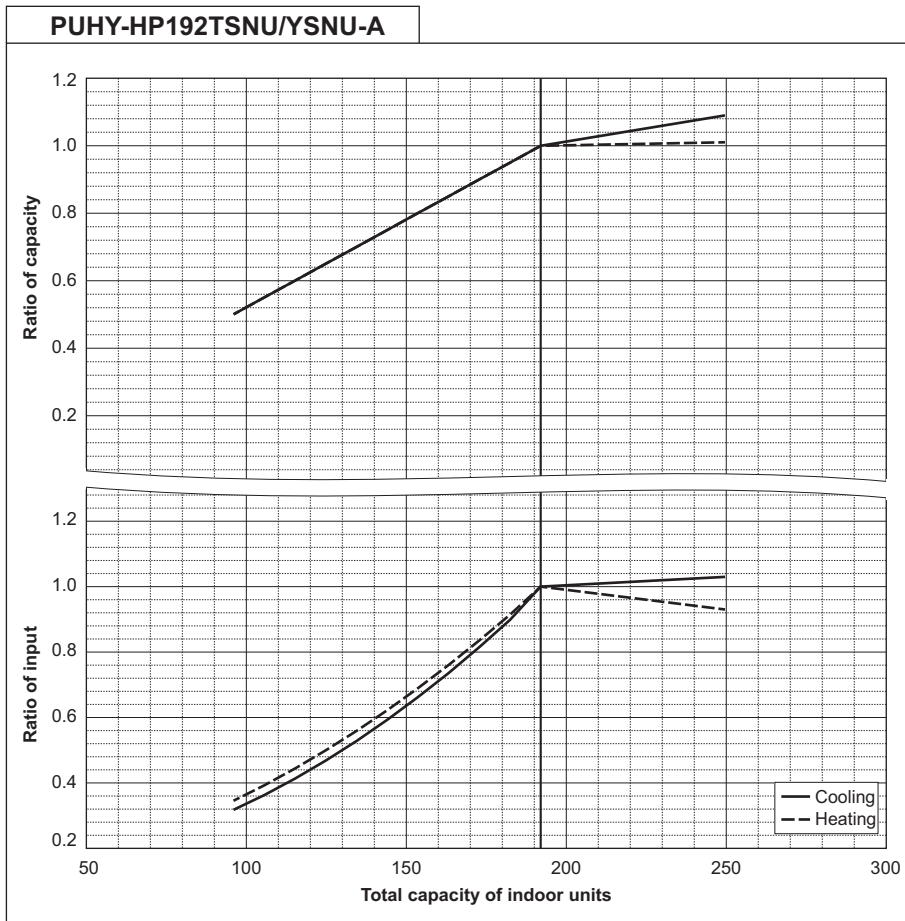

<b>PUHY-</b>		<b>HP240TSNU/YSNU</b>	
		Non-Ducted	Ducted
Nominal cooling capacity	BTU/h	240,000	
	kW	70.3	
	Input kW	19.37	

<b>PUHY-</b>		<b>HP240TSNU/YSNU</b>	
		Non-Ducted	Ducted
Nominal Heating capacity	BTU/h	270,000	
	kW	79.1	
	Input kW	21.38	

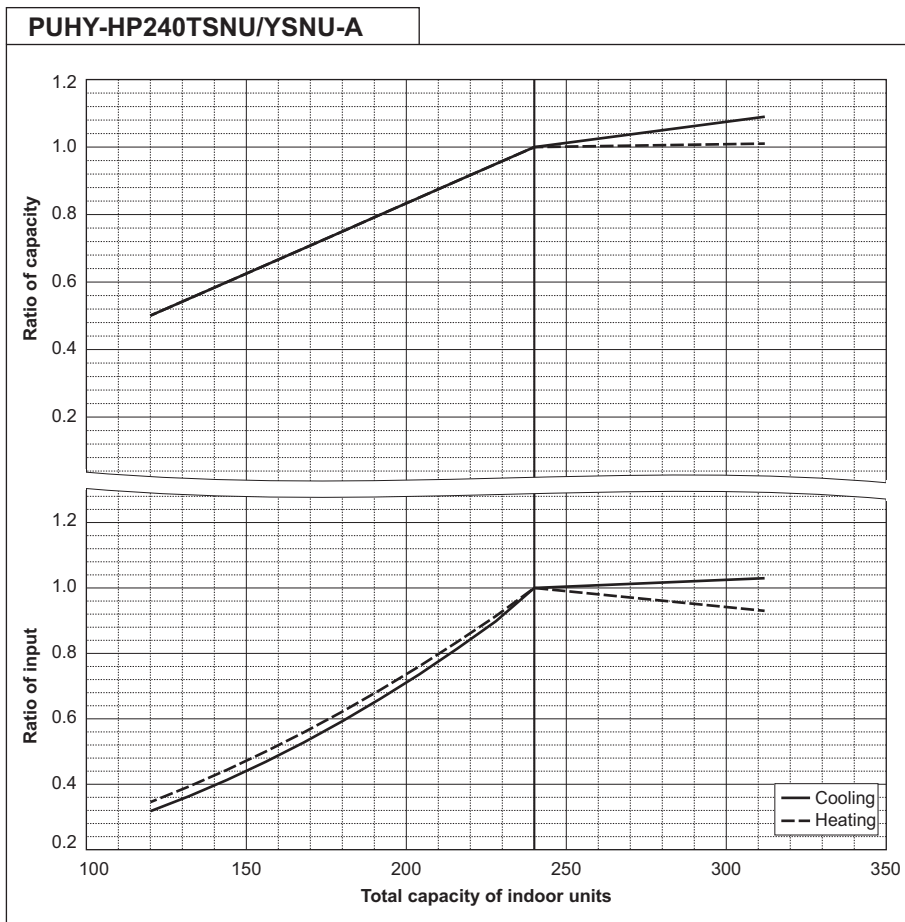

8-4. Correction by refrigerant piping length

CITY MULTI system can extend the piping flexibly within its limitation for the actual situation. However, a decrease of cooling/heating capacity could happen correspondently. Using following correction factor according to the equivalent length of the piping shown at 8-4-1 and 8-4-2, the capacity can be observed. 8-4-3 shows how to obtain the equivalent length of piping.

8-4-1. Cooling capacity correction

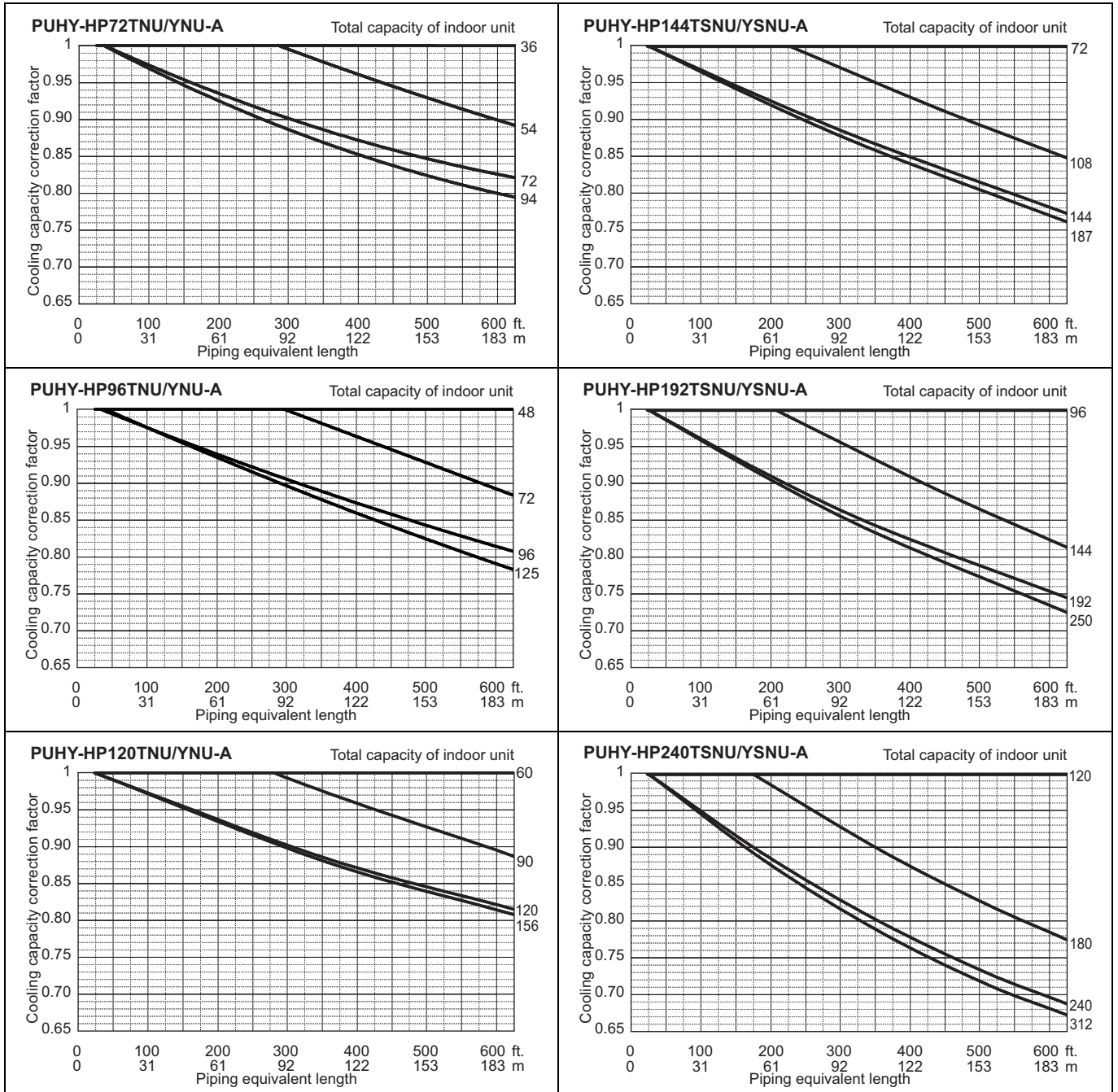

## 8-4-2. Heating capacity correction

PUHY-HP-T(S)NU-A, Y(S)NU-A

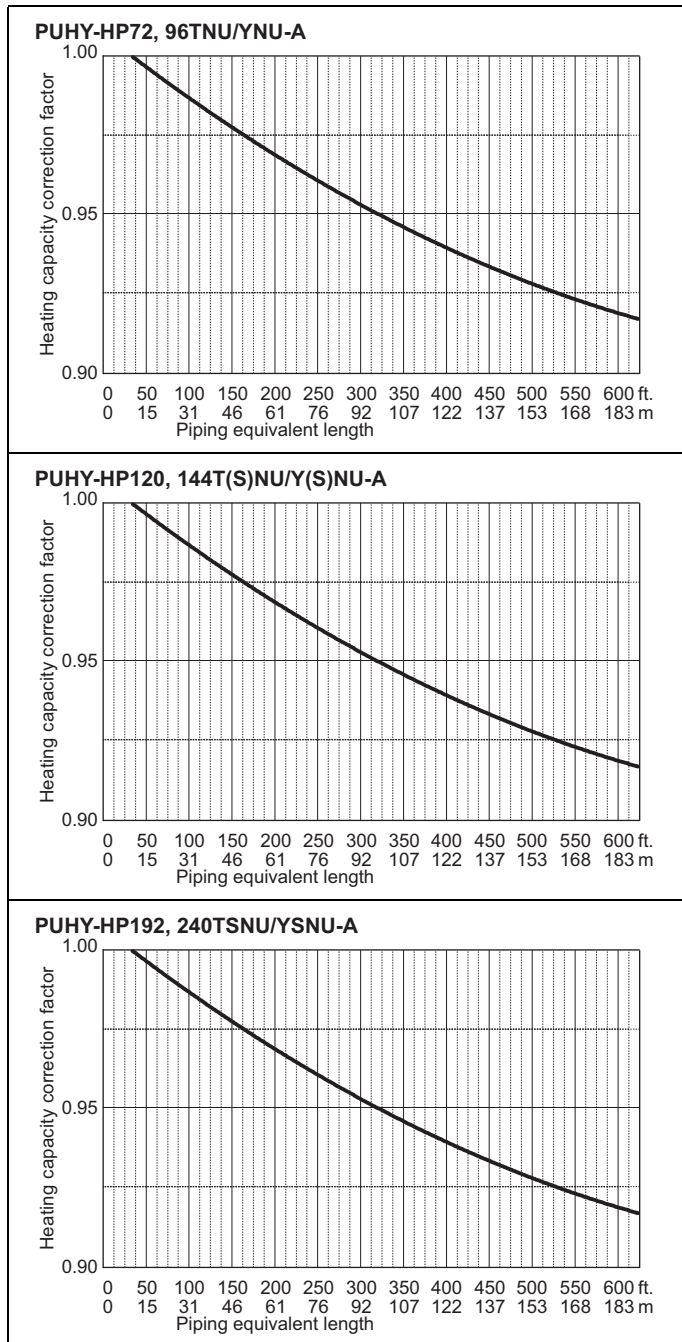

## 8-4-3. How to obtain the equivalent piping length

## 1. PUHY-HP72TNU/YNU

Equivalent length = (Actual piping length to the farthest indoor unit) + (1.15 × number of bent on the piping) [ft.]

Equivalent length = (Actual piping length to the farthest indoor unit) + (0.35 × number of bent on the piping) [m]

## 2. PUHY-HP96TNU/YNU

Equivalent length = (Actual piping length to the farthest indoor unit) + (1.38 × number of bent on the piping) [ft.]

Equivalent length = (Actual piping length to the farthest indoor unit) + (0.42 × number of bent on the piping) [m]

## 3. PUHY-HP120TNU/YNU

Equivalent length = (Actual piping length to the farthest indoor unit) + (1.38 × number of bent on the piping) [ft.]

Equivalent length = (Actual piping length to the farthest indoor unit) + (0.42 × number of bent on the piping) [m]

## 4. PUHY-HP144, 192, 240TSNU/YSNU

Equivalent length = (Actual piping length to the farthest indoor unit) + (1.64 × number of bent on the piping) [ft.]

Equivalent length = (Actual piping length to the farthest indoor unit) + (0.50 × number of bent on the piping) [m]

### 8-5. Correction at frost and defrost

Due to frost at the outdoor heat exchanger and the automatic defrost operation, the heating capacity of the outdoor unit can be calculated by multiplying the correction factor shown in the table below.

Table of correction factor at frost and defrost

Outdoor inlet air temp. °CWB	6	4	2	1	0	-2	-4	-6	-8	-10	-20
Outdoor inlet air temp. °FWB	43	39	36	34	32	28	25	21	18	14	-4
PUHY-HP72TNU-A	1.00	0.95	0.84	0.83	0.83	0.87	0.90	0.95	0.95	0.95	0.95
PUHY-HP96TNU-A	1.00	0.95	0.84	0.83	0.83	0.87	0.90	0.95	0.95	0.95	0.95
PUHY-HP120TNU-A	1.00	0.93	0.82	0.80	0.82	0.86	0.90	0.90	0.95	0.95	0.95
PUHY-HP144TSNU-A	1.00	0.95	0.84	0.83	0.83	0.87	0.90	0.95	0.95	0.95	0.95
PUHY-HP192TSNU-A	1.00	0.95	0.84	0.83	0.83	0.87	0.90	0.95	0.95	0.95	0.95
PUHY-HP240TSNU-A	1.00	0.93	0.82	0.80	0.82	0.86	0.90	0.90	0.95	0.95	0.95
PUHY-HP72YNU-A	1.00	0.95	0.84	0.83	0.83	0.87	0.90	0.95	0.95	0.95	0.95
PUHY-HP96YNU-A	1.00	0.95	0.84	0.83	0.83	0.87	0.90	0.95	0.95	0.95	0.95
PUHY-HP120YNU-A	1.00	0.93	0.82	0.80	0.82	0.86	0.90	0.90	0.95	0.95	0.95
PUHY-HP144YSNU-A	1.00	0.95	0.84	0.83	0.83	0.87	0.90	0.95	0.95	0.95	0.95
PUHY-HP192YSNU-A	1.00	0.95	0.84	0.83	0.83	0.87	0.90	0.95	0.95	0.95	0.95
PUHY-HP240YSNU-A	1.00	0.93	0.82	0.80	0.82	0.86	0.90	0.90	0.95	0.95	0.95

#### Note

- The high humidity condition (e.g., a foggy atmosphere) which causes frost forming on the heat exchanger will worsen the heating performance of the unit.
- The snow blowing to the heat exchanger will worsen the heating performance of the unit. Install a snow hood as a preventive measure.
- The correction factors in the table above are used for a full-load and above.  
Use the formula below to calculate the correction factor to use for a partial load.

Correction factor for partial load: K

Correction factor for a full load and above:  $K_0$

Partial load factor: A

$$K = 1 - (1 - K_0) \times A$$

### 8-6. Correction at evaporation-temperature (ET) control

When the target evaporation temperature is changed, the capacity or the power input can be calculated by multiplying the correction factor shown in the table below.

ET *1	°C	6	9	11	14
	°F	43	48	52	57
Correction factor	Capacity	0.90	0.83	0.71	0.55
	Power Input	0.90	0.72	0.54	0.36

\*1 The evaporation temperature in operation may be different from the preset target evaporation temperature because it depends on such factors as the unit protection control.

The capacity and power input could also fluctuate.

\*2 Use the table above which indicates the unit properties as a reference

PUHY-HP-T(S)NU-A, Y(S)NU-A

**9-1. JOINT**

CITY MULTI units can be easily connected by using Joint sets and Header sets provided by Mitsubishi Electric. Refer to section "Piping Design" or the Installation Manual that comes with the Joint set for how to install the Joint set.

**CMY-Y102SS-G2**

in.

For Gas pipe:

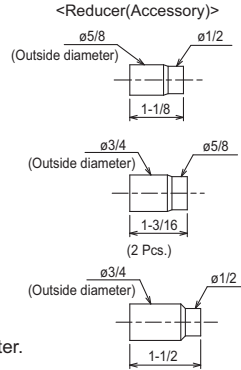
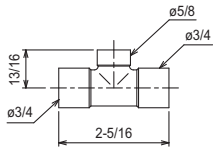

For Liquid pipe:

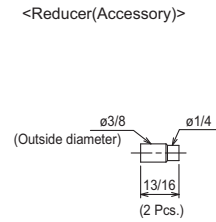
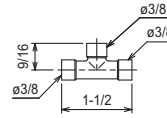

\*Pipe diameter is indicated by inside diameter.

**CMY-Y102LS-G2**

in.

For Gas pipe:

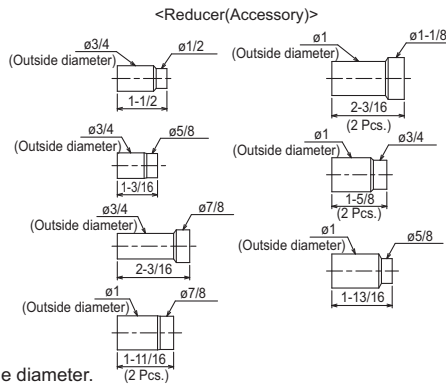
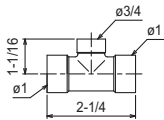

For Liquid pipe:

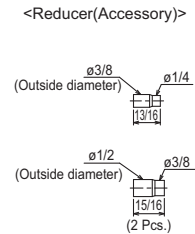
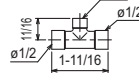

\*Pipe diameter is indicated by inside diameter.

**CMY-Y202S-G2**

in.

For Gas pipe:

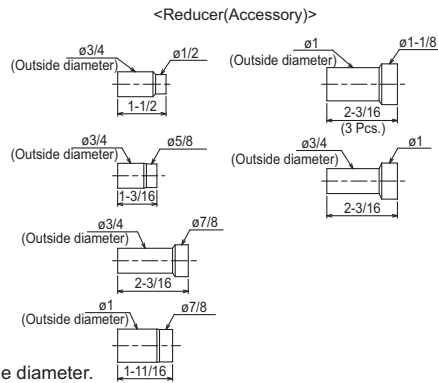
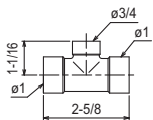

For Liquid pipe:

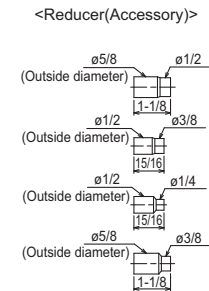
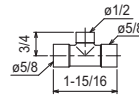

\*Pipe diameter is indicated by inside diameter.

**CMY-Y302S-G2**

in.

For Gas pipe:

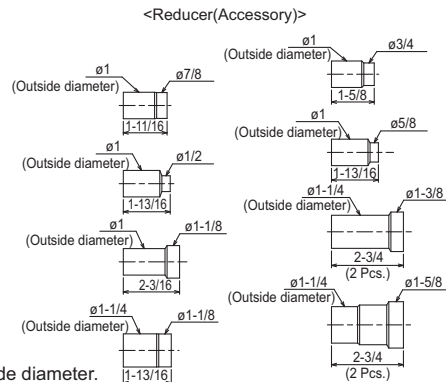
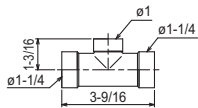

For Liquid pipe:

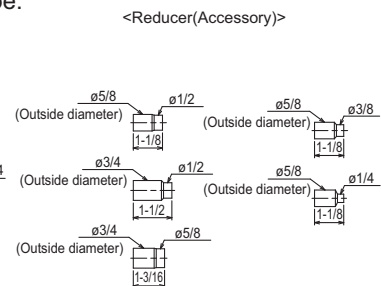
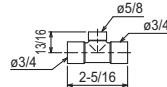

\*Pipe diameter is indicated by inside diameter.



9-2. HEADER

CITY MULTI units can be easily connected by using Joint sets and Header sets provided by Mitsubishi Electric. Refer to section "Piping Design" or the Installation Manual that comes with the Header set for how to install the Header set.

**CMY-Y104C-G**

For gas pipe:

<Reducer(Accessory)>  
 ID $\phi$ 5/8" ID $\phi$ 1/2" (3 Pcs.)

For liquid pipe:

<Reducer(Accessory)>  
 OD $\phi$ 3/8" ID $\phi$ 1/4" (3 Pcs.)

ID: Inner Diameter OD: Outer Diameter  
 NOTE: Besides above mentioned accessories, caps for  $\phi$ 1/4",  $\phi$ 3/8",  $\phi$ 1/2",  $\phi$ 5/8" pipes (each diameter 1 piece) are included in the Header set.

**CMY-Y108C-G**

For gas pipe:

<Reducer(Accessory)>  
 ID $\phi$ 1/2" ID $\phi$ 5/8" ID $\phi$ 7/8" OD $\phi$ 3/4" ID $\phi$ 5/8" ID $\phi$ 3/4" (5 Pcs.) (2 Pcs.)

For liquid pipe:

<Reducer(Accessory)>  
 ID $\phi$ 1/4" OD $\phi$ 3/8" (6 Pcs.)

ID: Inner Diameter OD: Outer Diameter  
 NOTE: Besides above mentioned accessories, caps for  $\phi$ 1/4",  $\phi$ 3/8",  $\phi$ 1/2",  $\phi$ 5/8" pipes (each diameter 2 pieces) and 1 cap for  $\phi$ 3/4" pipe are included in the Header set.

**CMY-Y1010C-G**

For gas pipe:

<Reducer(Accessory)>  
 ID $\phi$ 1/2" ID $\phi$ 5/8" ID $\phi$ 1/2" ID $\phi$ 3/4" ID $\phi$ 5/8" ID $\phi$ 7/8" OD $\phi$ 3/4" OD $\phi$ 5/8" OD $\phi$ 1/2" (2 Pcs.) (2 Pcs.) (5 Pcs.) (3 Pcs.)

For liquid pipe:

<Reducer(Accessory)>  
 ID $\phi$ 1/4" ID $\phi$ 3/8" OD $\phi$ 1/2" OD $\phi$ 3/8" OD $\phi$ 1/4" (5 Pcs.) (5 Pcs.)

ID: Inner Diameter OD: Outer Diameter  
 NOTE: Besides above mentioned accessories, caps for  $\phi$ 1/4",  $\phi$ 3/8",  $\phi$ 1/2",  $\phi$ 5/8" pipes (each diameter 2 pieces) and 1 cap for  $\phi$ 3/4" pipe are included in the Header set.



9-3. OUTDOOR TWINNING KIT

The following optional Outdoor Twinning Kit is needed to use to combine multiple refrigerant pipes. Refer to section "Piping Design" for the details of selecting a proper twinning kit.

PUHY-HP-T(S)NU-A, Y(S)NU-A

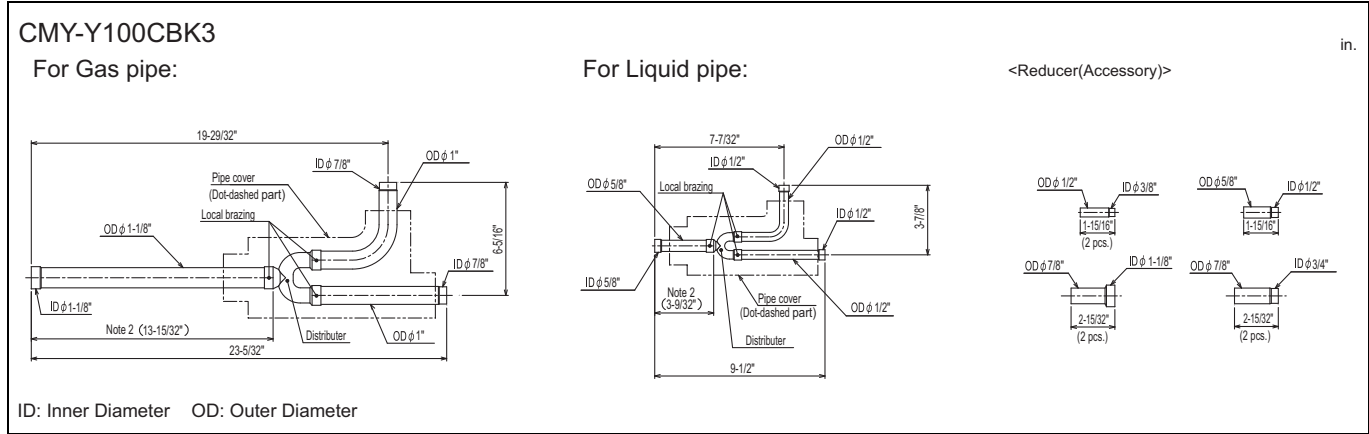

Note 1. Reference the attitude angle of the twinning pipe below the fig.

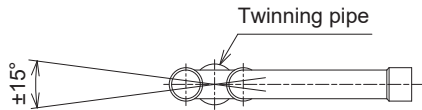

The angle of the twinning pipe is within  $\pm 15^\circ$  against the horizontal plane.

2. Use the attached pipe to braze the port-opening of the twinning pipe.
3. Pipe diameter is indicated by inside diameter.
4. Only use the Twinning pipe by Mitsubishi (optional parts).

9-4. FIN GUARD

PAC-FG01S-E

For side surfaces of L module (a set of two pieces)

■Left side of the unit

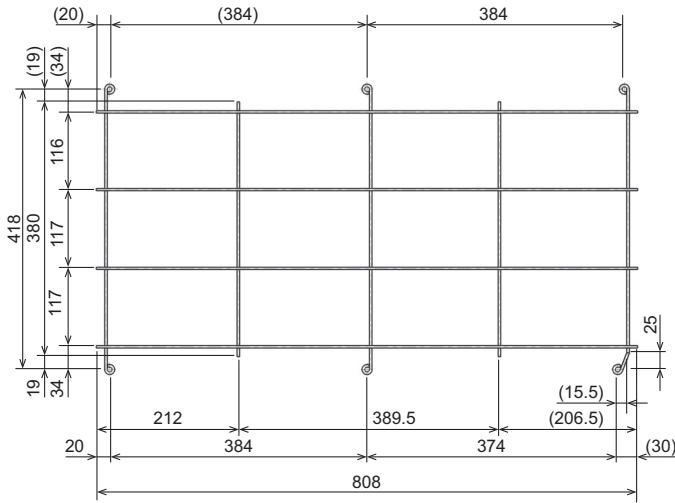

■Right side of the unit

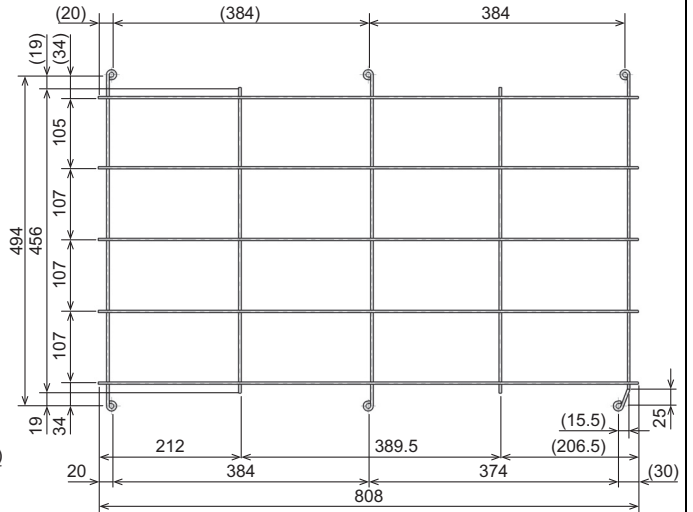

PAC-FG02B-E

For rear surface of L module (a set of two pieces)

■Behind the unit (left)

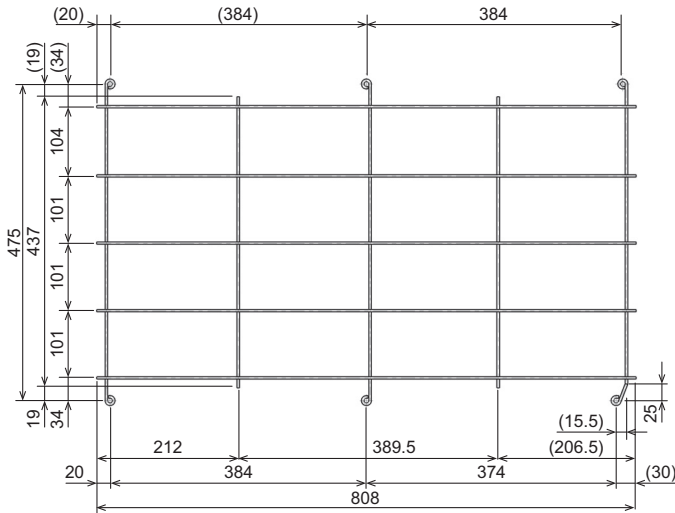

■Behind the unit (right)

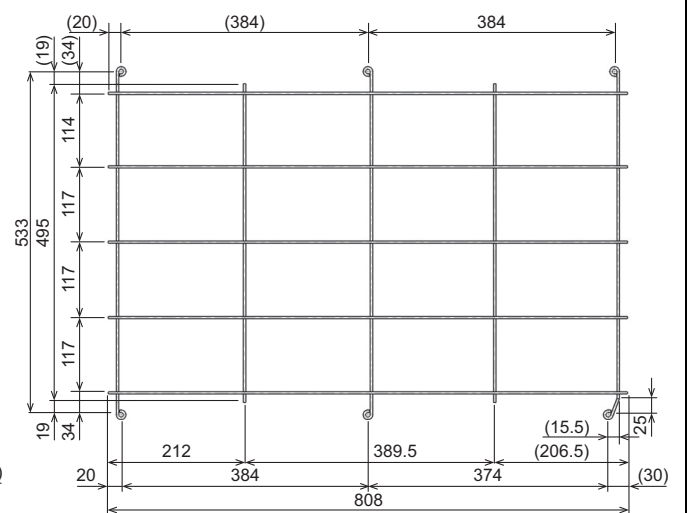

PUHY-HP-T(S)NU-A, Y(S)NU-A

**10-1. General cautions**

- ① Follow ordinance of your governmental organization for technical standard related to electrical equipment, wiring regulations, and guidance of each electric power company.
- ② Wiring for control (hereinafter referred to as transmission cable) shall be (50mm[1-5/8in] or more) apart from power source wiring so that it is not influenced by electric noise from power source wiring. (Do not insert transmission cable and power source wire in the same conduit.)
- ③ Be sure to provide designated grounding work to outdoor unit.
- ④ Give some allowance to wiring for electrical part box of indoor and outdoor units, because the box is sometimes removed at the time of service work.
- ⑤ Never connect 100V, 208~230, 460V power source to terminal block of transmission cable. If connected, electrical parts will be damaged.
- ⑥ Use 2-core shield cable for transmission cable. If transmission cables of different systems are wired with the same multiple-core cable, the resultant poor transmitting and receiving will cause erroneous operations.
- ⑦ When extending the transmission line, make sure to extend the shield cable as well.

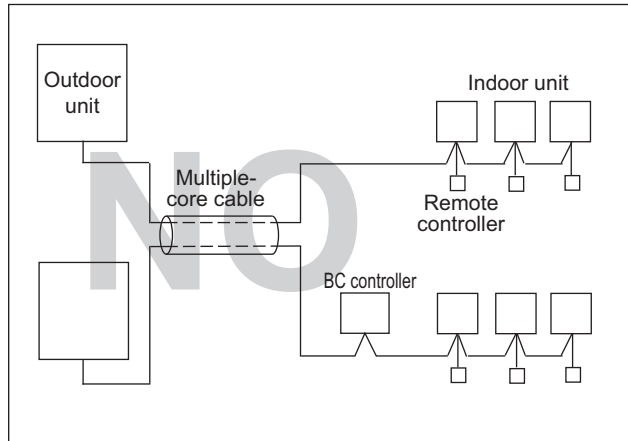
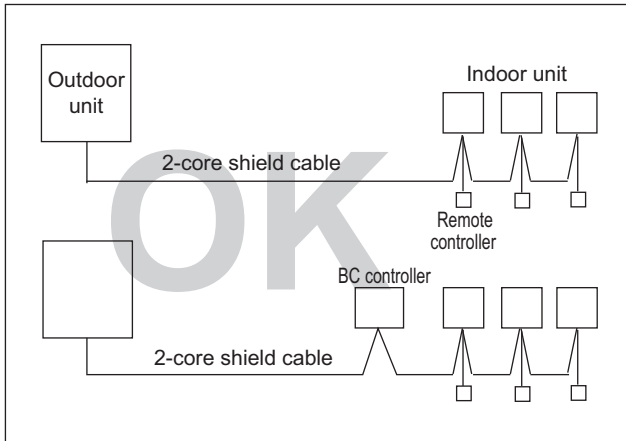

## 10-2. Power supply for Outdoor unit

### 10-2-1. Electrical characteristics of Outdoor unit at cooling mode

MOP is used to select the fuse, switch, or breaker for current leakage.

Symbols: MCA: Minimum Circuit Ampacity

SC: Starting Current

MOP: Maximum Overcurrent Protection

PUHY-HP-T(S)NU

Model name	Combination	Outdoor Units					Compressor		Fan
		Hz	Volts	Voltage range	MCA (A)	MOP (A)	Output (kW)	SC (A)	Output (kW)
PUHY-HP72TNU-A	-	60Hz	208/230V	188 to 253V	55/49	90/80	3.8	15	0.46+0.46
PUHY-HP96TNU-A	-				63/57	100/90	4.5	15	0.46+0.46
PUHY-HP120TNU-A	-				66/60	110/100	6.5	15	0.46+0.46
PUHY-HP144TSNU-A	PUHY-HP72TNU-A				55/49	90/80	3.8	15	0.46+0.46
	PUHY-HP72TNU-A				55/49	90/80	3.8	15	0.46+0.46
PUHY-HP192TSNU-A	PUHY-HP96TNU-A				63/57	100/90	4.5	15	0.46+0.46
	PUHY-HP96TNU-A				63/57	100/90	4.5	15	0.46+0.46
PUHY-HP240TSNU-A	PUHY-HP120TNU-A				66/60	110/100	6.5	15	0.46+0.46
	PUHY-HP120TNU-A				66/60	110/100	6.5	15	0.46+0.46

PUHY-HP-Y(S)NU

Model name	Combination	Outdoor Units					Compressor		Fan
		Hz	Volts	Voltage range	MCA (A)	MOP (A)	Output (kW)	SC (A)	Output (kW)
PUHY-HP72YNU-A	-	60Hz	460V	414 to 506V	25	40	3.8	7	0.46+0.46
PUHY-HP96YNU-A	-				29	45	4.5	7	0.46+0.46
PUHY-HP120YNU-A	-				35	50	6.5	7	0.46+0.46
PUHY-HP144YSNU-A	PUHY-HP72YNU-A				25	40	3.8	7	0.46+0.46
	PUHY-HP72YNU-A				25	40	3.8	7	0.46+0.46
PUHY-HP192YSNU-A	PUHY-HP96YNU-A				29	45	4.5	7	0.46+0.46
	PUHY-HP96YNU-A				29	45	4.5	7	0.46+0.46
PUHY-HP240YSNU-A	PUHY-HP120YNU-A				35	50	6.5	7	0.46+0.46
	PUHY-HP120YNU-A				35	50	6.5	7	0.46+0.46

10-3. Power cable specifications

Thickness of wire for main power supply, capacities of the switch and system impedance

3-phase 3-wire, 208/230V, 60Hz		Minimum cable size [mm <sup>2</sup> (AWG)]				Breaker for current leakage	
		Main cable		Ground			
		208V	230V	208V	230V	208V	230V
PUHY-HP-TNU-A	HP72	21.2 (4)	13.3 (6)	21.2 (4)	13.3 (6)	60A 100mA 0.1sec. or less	50A 100mA 0.1sec. or less
	HP96	21.2 (4)	21.2 (4)	21.2 (4)	21.2 (4)	70A 100mA 0.1sec. or less	60A 100mA 0.1sec. or less
	HP120	21.2 (4)	21.2 (4)	21.2 (4)	21.2 (4)	70A 100mA 0.1sec. or less	60A 100mA 0.1sec. or less

3-phase 3-wire, 460V, 60Hz		Minimum wire thickness [mm <sup>2</sup> (AWG)]			Breaker for current leakage 460V
		Main cable	Branch	Ground	
PUHY-HP-YNU-A	HP72	5.3 (10)	-	5.3 (10)	25A 30mA or 100mA 0.1sec. or less
	HP96	5.3 (10)	-	5.3 (10)	30A 30mA or 100mA 0.1sec. or less
	HP120	8.4 (8)	-	8.4 (8)	35A 30mA or 100mA 0.1sec. or less

1. Use dedicated power supplies for the outdoor unit. Ensure OC and OS are wired individually.
2. Bear in mind ambient conditions (ambient temperature, direct sunlight, rain water, etc.) when proceeding with the wiring and connections.
3. The wire size is the minimum value for metal conduit wiring. If the voltage drops, use a wire that is one rank thicker in diameter. Make sure the power-supply voltage does not drop more than 10%. Make sure that the voltage imbalance between the phases is 2% or less.
4. Specific wiring requirements should adhere to the wiring regulations of the region.
5. Power supply cords of parts of appliances for outdoor use shall not be lighter than polychloroprene sheathed flexible cord (design 245 IEC57). For example, use wiring such as YZW.
6. A switch with at least 3 mm [1/8 in.] contact separation in each pole shall be provided by the Air Conditioner installer.
7. For details on indoor unit wiring and breaker for current leakage, refer to the indoor unit Instruction Book and Installation Manual.

**⚠ WARNING**

- ◆ Be sure to use specified wires for connections and ensure no external force is imparted to terminal connections. If connections are not fixed firmly, heating or fire may result.
- ◆ Be sure to use the appropriate type of overcurrent protection switch. Note that generated overcurrent may include some amount of direct current.

**⚠ CAUTION**

- ◆ The breakers for current leakage should support Inverter circuit. (e.g. Mitsubishi Electric's NV-C-Series or equivalent). If no earth leakage breaker is installed, it may cause an electric shock.
- ◆ Breakers for current leakage should combine using of switch.
- ◆ Do not use anything other than a breaker with the correct capacity. Using a breaker of too large capacity may cause malfunction or fire.
- ◆ If a large electric current flows due to malfunction or faulty wiring, earth-leakage breakers on the unit side and on the upstream side of the power supply system may both operate.  
Depending on the importance of the system, separate the power supply system or take protective coordination of breakers.

PUHY-HP-T(S)NU-A, Y(S)NU-A

10-4. Power supply examples

The local standards and/or regulations is applicable at a higher priority.  
 10-4-1. PUHY-HP72, 96, 120TNU/YNU

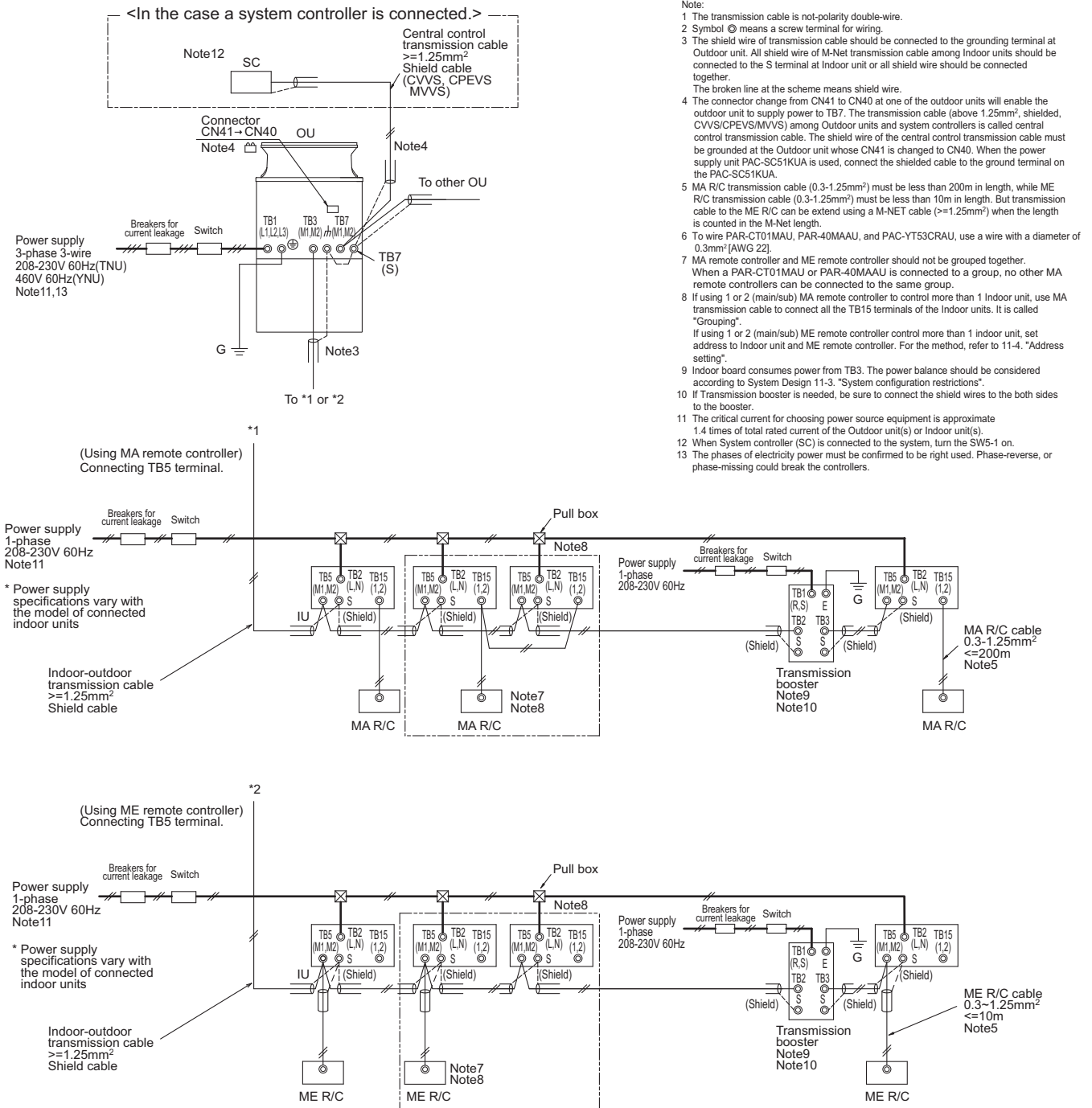

Symbol	Model	Minimum Wire thickness				Breaker for current leakage	
		Power wire [mm <sup>2</sup> (AWG)]		G wire [mm <sup>2</sup> (AWG)]		208V	230V
OU	Outdoor unit	208V	230V	208V	230V	208V	230V
IU	Indoor unit	21.2 (4)	13.3 (6)	21.2 (4)	13.3 (6)	60A 100mA 0.1sec. or less	50A 100mA 0.1sec. or less
SC	System controller	21.2 (4)	21.2 (4)	21.2 (4)	21.2 (4)	70A 100mA 0.1sec. or less	60A 100mA 0.1sec. or less
MA R/C	MA remote controller	21.2 (4)	21.2 (4)	21.2 (4)	21.2 (4)	70A 100mA 0.1sec. or less	60A 100mA 0.1sec. or less
ME R/C	ME remote controller	460V		460V		460V	
		5.3 (10)		5.3 (10)		25A 30mA or 100mA 0.1sec. or less	
		5.3 (10)		5.3 (10)		30A 30mA or 100mA 0.1sec. or less	
		8.4 (8)		8.4 (8)		35A 30mA or 100mA 0.1sec. or less	



The local standards and/or regulations is applicable at a higher priority.  
 10-4-2. PUYH-HP144, 192, 240TSNU/YSNU

PUYH-HP-T(S)NU-A, Y(S)NU-A

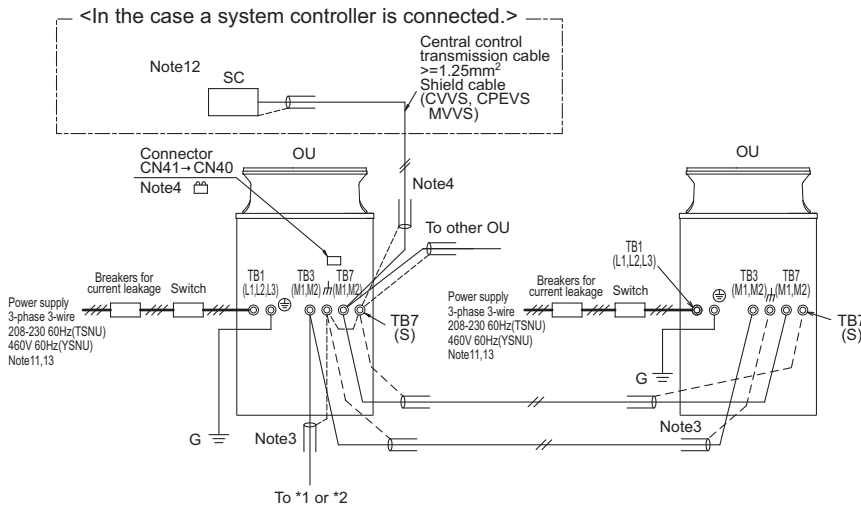

Note:

- 1 The transmission cable is not-polarity double-wire.
- 2 Symbol ⊕ means a screw terminal for wiring.
- 3 The shield wire of transmission cable should be connected to the grounding terminal at Outdoor unit. All shield wire of M-Net transmission cable among Indoor units should be connected to the S terminal at Indoor unit or all shield wire should be connected together. The broken line at the scheme means shield wire.
- 4 The connector change from CN41 to CN40 at one of the outdoor units will enable the outdoor unit to supply power to TB7. The transmission cable (above 1.25mm², shielded, CVVS/CPEVS/MVVS) among Outdoor units and system controllers is called central control transmission cable. The shield wire of the central control transmission cable must be grounded at the Outdoor unit whose CN41 is changed to CN40. When the power supply unit PAC-SC51KUA is used, connect the shielded cable to the ground terminal on the PAC-SC51KUA.
- 5 MA R/C transmission cable (0.3-1.25mm²) must be less than 200m in length, while ME R/C transmission cable (0.3-1.25mm²) must be less than 10m in length. But transmission cable to the ME R/C can be extend using a M-NET cable (>=1.25mm²) when the length is counted in the M-Net length.
- 6 To wire PAR-CT01MAU, PAR-40MAAU, and PAC-YT53CRAU, use a wire with a diameter of 0.3mm² [AWG 22].
- 7 MA remote controller and ME remote controller should not be grouped together. When a PAR-CT01MAU or PAR-40MAAU is connected to a group, no other MA remote controllers can be connected to the same group.
- 8 If using 1 or 2 (main/sub) MA remote controller to control more than 1 Indoor unit, use MA transmission cable to connect all the TB15 terminals of the Indoor units. It is called "Grouping". If using 1 or 2 (main/sub) ME remote controller control more than 1 Indoor unit, set address to Indoor unit and ME remote controller. For the method, refer to 11-4. "Address setting".
- 9 Indoor board consumes power from TB3. The power balance should be considered according to System Design 11-3. "System configuration restrictions".
- 10 If Transmission booster is needed, be sure to connect the shield wires to the both sides to the booster.
- 11 The critical current for choosing power source equipment is approximate 1.4 times of total rated current of the Outdoor unit(s) or Indoor unit(s).
- 12 When System controller (SC) is connected to the system, turn the SW5-1 on.
- 13 The phases of electricity power must be confirmed to be right used. Phase-reverse, or phase-missing could break the controllers.

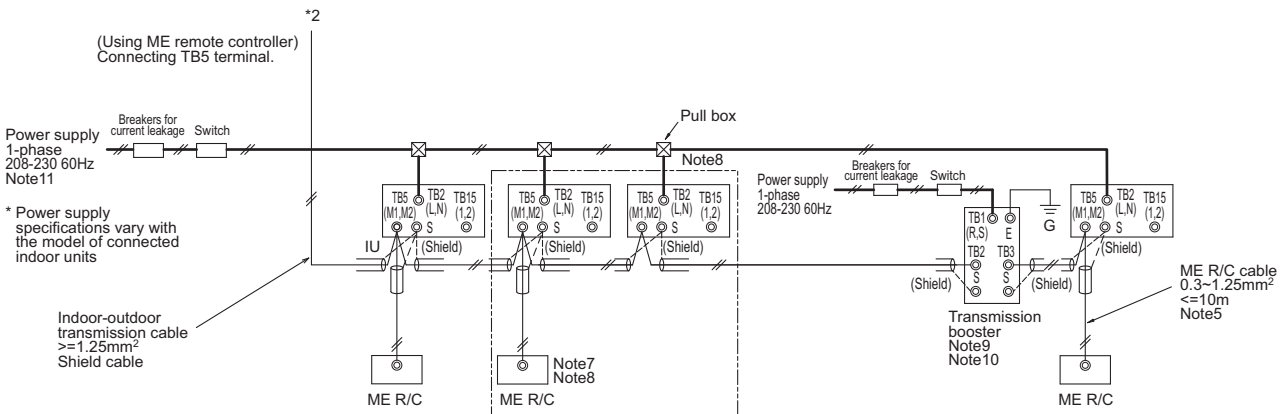
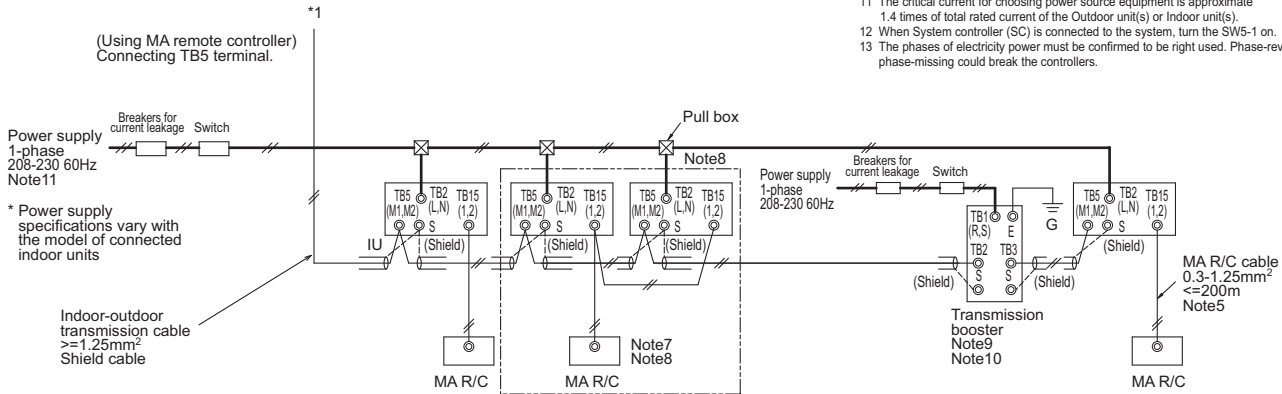

Symbol	Model	Minimum Wire thickness				Breaker for current leakage	
		Power wire [mm² (AWG)]		G wire [mm² (AWG)]		208V	230V
OU	Outdoor unit	208V	230V	208V	230V	208V	230V
IU	Indoor unit	21.2 (4)	13.3 (6)	21.2 (4)	13.3 (6)	60A 100mA 0.1sec. or less	50A 100mA 0.1sec. or less
SC	System controller	21.2 (4)	21.2 (4)	21.2 (4)	21.2 (4)	70A 100mA 0.1sec. or less	60A 100mA 0.1sec. or less
MA R/C	MA remote controller	21.2 (4)	21.2 (4)	21.2 (4)	21.2 (4)	70A 100mA 0.1sec. or less	60A 100mA 0.1sec. or less
ME R/C	ME remote controller	460V				460V	
		5.3 (10)		5.3 (10)		25A 30mA or 100mA 0.1sec. or less	
		5.3 (10)		5.3 (10)		30A 30mA or 100mA 0.1sec. or less	
		8.4 (8)		8.4 (8)		35A 30mA or 100mA 0.1sec. or less	

### 11-1. Transmission cable length limitation

#### 11-1-1. Using MA Remote controller

MA remote controller refers to Simple MA remote controller and wireless remote controller.

Long transmission cable causes voltage down, therefore, the length limitation should be obeyed to secure proper transmission.

Max. length via Outdoor (M-NET cable)	$L_1+L_2+L_3, L_1+L_2+L_4+L_5, L_3+L_4+L_5, L_6+L_2+L_3, L_6+L_2+L_4+L_5$	$\leq 500\text{m}[1640\text{ft.}]$	1.25mm <sup>2</sup> [AWG16] or thicker
Max. length to Outdoor (M-NET cable)	$L_1+L_6, L_3, L_2+L_4+L_6, L_5$	$\leq 200\text{m}[656\text{ft.}]$	1.25mm <sup>2</sup> [AWG16] or thicker
Max. length from MA to Indoor for each group	$a_1+a_2, a_1+a_2+a_3+a_4$	$\leq 200\text{m}[656\text{ft.}]$	0.3-1.25 mm <sup>2</sup> [AWG22-16]
24VDC to AG-150A-A	n	$\leq 50\text{m}[164\text{ft.}]$	0.75-2.0 mm <sup>2</sup> [AWG18-14]

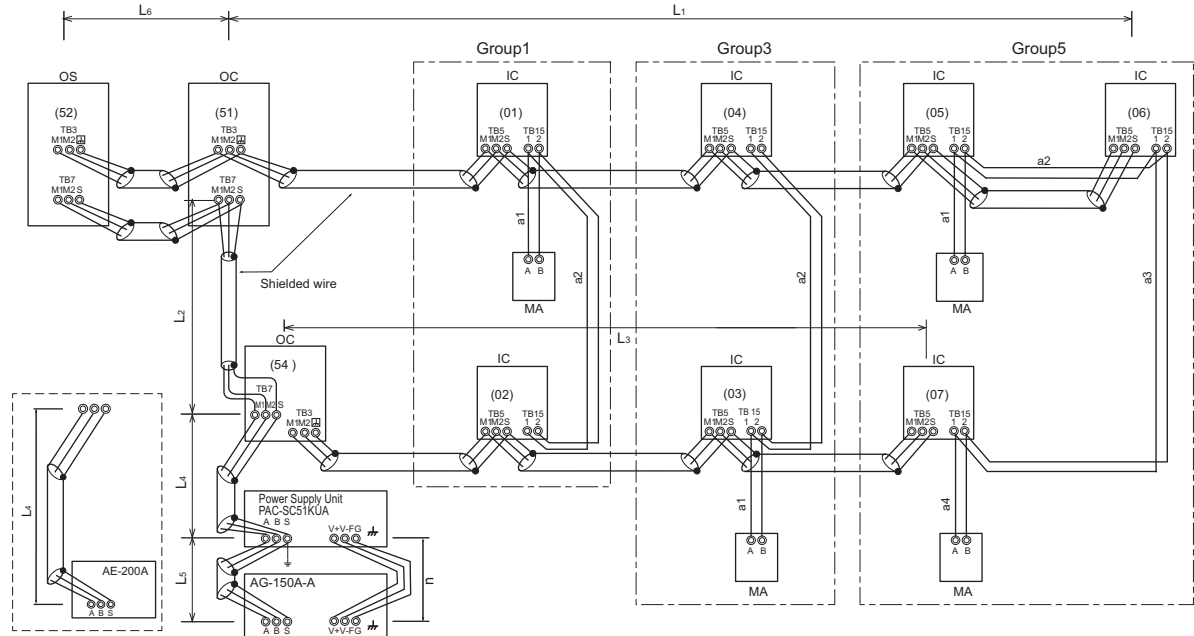

OC, OS: Outdoor unit controller; IC: Indoor unit controller; MA: MA remote controller

#### 11-1-2. Using ME Remote controller

ME remote controller refers to Smart ME Controller.

Long transmission cable causes voltage down, therefore, the length limitation should be obeyed to secure proper transmission.

Max. length via Outdoor (M-NET cable)	$L_1+L_2+L_3+L_4, L_1+L_2+L_5+L_6, L_3+L_4+L_5+L_6, L_7+L_2+L_3+L_4, L_7+L_2+L_5+L_6, L_3+L_5+L_6$	$\leq 500\text{m}[1640\text{ft.}]$	1.25mm <sup>2</sup> [AWG16] or thicker
Max. length to Outdoor (M-NET cable)	$L_1+L_7, L_3+L_4, L_2+L_5+L_7, L_6$	$\leq 200\text{m}[656\text{ft.}]$	1.25mm <sup>2</sup> [AWG16] or thicker
Max. length from ME to Indoor	$e_1, e_2, e_3, e_4$	$\leq 10\text{m}[32\text{ft.}]^*1$	0.3-1.25 mm <sup>2</sup> [AWG22-16] *1
24VDC to AG-150A-A	n	$\leq 50\text{m}[164\text{ft.}]$	0.75-2.0 mm <sup>2</sup> [AWG18-14]

\*1. If the length from ME to Indoor exceed 10m, use 1.25 mm<sup>2</sup> [AWG16] shielded cable, but the total length should be counted into Max. length via Outdoor.

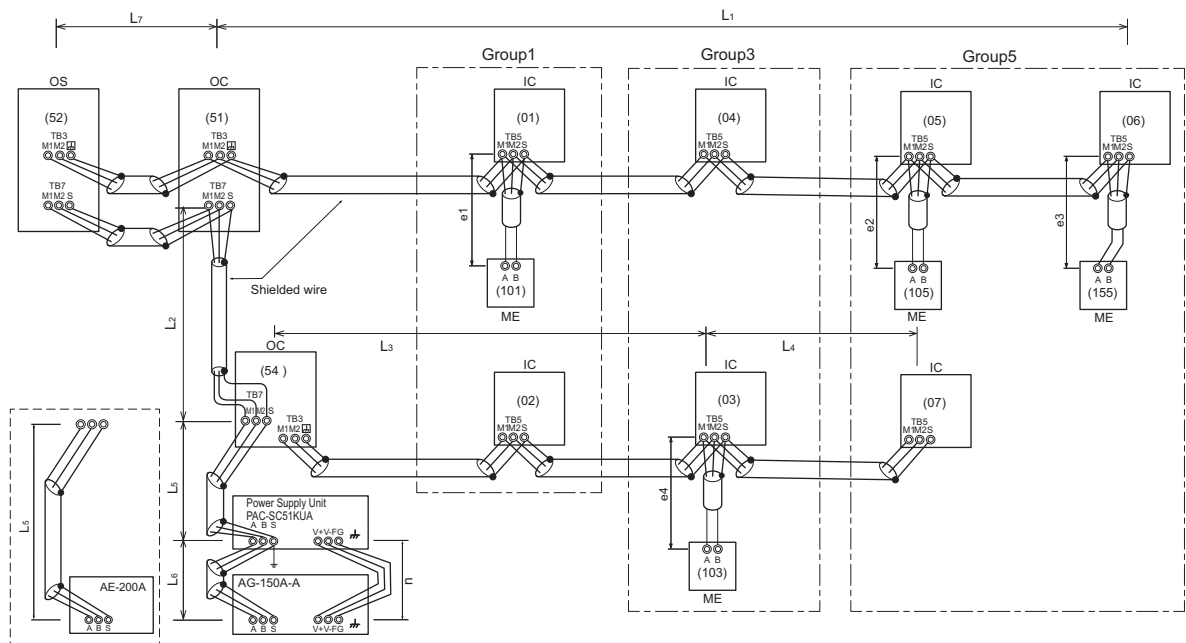

OC, OS: Outdoor unit controller; IC: Indoor unit controller; ME: ME remote controller

11-2. Transmission cable specifications

	Transmission cables (Li)	MA Remote controller cables	ME Remote controller cables
Type of cable	Shielded cables (2-core) CVVS, CPEVS, and MVVS	VCTF, VCTFK, CVV, VVR, VVF, VCT	Shielded cables (2-core) CVVS, CPEVS, and MVVS
Cable size	Larger than 1.25 mm <sup>2</sup> [AWG16], or ø1.2 mm or above	0.3 to 1.25 mm <sup>2</sup> [AWG22 to 16] *1 *5	0.3 to 1.25 mm <sup>2</sup> [AWG22 to 16] *1 *6
Maximum overall line length	Refer to 11-1.	200 m [656 ft] *3 *4	10 m [32 ft] *2

\*1 The use of cables that are smaller than 0.75 mm<sup>2</sup> (AWG18) is recommended for easy handling.

\*2 The section of the cable that exceeds 10 m [32 ft] must be included in the maximum indoor-outdoor transmission line distance.

\*3 Max. 70 m [229 ft] for PAR-CT01MA series

\*4 Max. 150 m [492 ft] for PAR-FS01MA series

\*5 To wire PAR-CT01MA series, PAR-FS01MA series, PAR-4"x"MA series, PAR-3"x"MA series ("x" represents 0 or later), or Simple MA remote controller, use a cable with a size of 0.3 mm<sup>2</sup> (AWG 22).

\*6 When connected to the terminal block on the Simple remote controller, use a cable with a size of 0.75 to 1.25 mm<sup>2</sup> (AWG18 to 16).

CVVS, MVVS: PVC insulated PVC sheathed shielded control cable  
CPEVS: PE insulated PVC sheathed shielded communication cable  
CVV: PVC insulated PVC sheathed control cable

PUHY-HP-T(S)NU-A, Y(S)NU-A

### 11-3. System configuration restrictions

#### 11-3-1. Common restrictions for the CITY MULTI system

For each Outdoor/Heat source unit, the maximum connectable quantity of Indoor unit is specified at its Specifications table.

- A) 1 Group of Indoor units can have 1-16 Indoor units;
- B) Maximum 2 remote controllers for 1 group;
  - \*MA/ME remote controllers cannot be present together in 1group.
  - \*When the PAR-CT01MA series, PAR-FS01MA series, PAR-4"x"MA series, or PAR-3"x"MA series ("x" represents 0 or later) is connected to a group, no other MA remote controllers can be connected to the same group.
- C) 1 LOSSNAY unit can interlock maximum 16 Indoor units; 1 Indoor unit can interlock only 1 LOSSNAY unit.
- D) Maximum 3 System controllers are connectable when connecting to TB3 of the Outdoor/Heat source unit.
- E) A maximum of 6 system controller are connectable to TB3 and TB7 of Outdoor/Heat source unit.
- F) 4 System controllers or more are connectable when connecting to TB7 of the Outdoor/Heat source unit, if the transmission power is supplied by the power supply unit PAC-SC51KUA.
  - \*System controller connected as described in D) would have a risk that the failure of connected Outdoor/Heat source unit would stop power supply to the System controller.

#### 11-3-2. Ensuring proper communication power and the number of connected units for M-NET

In order to ensure proper communication among Outdoor/Heat source unit, Indoor unit, LOSSNAY, and Controllers, the transmission power situation for the M-NET should be observed. In some cases, Transmission booster should be used.

Taking the power consumption of Indoor unit as 1, the equivalent power consumption or supply of others are listed at Table 1 and Table 2.

Both the transmission line for centralized controller and indoor-outdoor transmission line must meet the conditions listed below. (Both conditions a) and b) must be met.)

- a) [Total equivalent power consumption] ≤ [The equivalent power supply]
- b) [Total equivalent number of units (Table1)] ≤ [40]

Table 1 The equivalent power consumption and the equivalent number of units

Category	Model	The equivalent power consumption	The equivalent number of units
Indoor unit	Sized P04-P96, PEFY-AF1200CFM-E	1	1
	PEFY-AF1200CFMR-E	2	2
BC controller	CMB	2	1
PWFY *1	P36NMU-E-BU	6	1
	P36NMU-E2-AU	1	1
	P72NMU-E2-AU	5	1
MA remote controller/LOSSNAY	PAR-CT01MAU PAR-41MAAU PAC-YT53CRAU PAR-FA32MA LGH-F-RX <sub>5</sub> -E1 LGH-F-RVX-E PZ-60DR-E PZ-61DR-E PZ-43SMF-E	0	0
ME remote controller	PAR-U01MEDU	0.5	1
System controller	AE-200A AE-50A EW-50A LM-AP	0	0
	AG-150A-A EB-50GU-A PAC-IF01AHC-J	0.5	1
	TC-24B	1.5	5
	PAC-YG60MCA PAC-YG66DCA PAC-YG63MCA	0.25	1
ON/OFF controller	PAC-YT40ANRA	1	1
MN converter	CMS-MNG-E	2	1
Outdoor/Heat source unit	TB7 power consumption	0	0
System control interface	MAC-333IF-E	0	0
A-M converter	PAC-IF01MNT-E	1	2

\*1 PWFY cannot be connected to PUMY model.

Table 2 The equivalent power supply

Category	Model	The equivalent power supply		
Transmission Booster	PAC-SF46EPA-G	25 *1		
Power supply unit	PAC-SC51KUA	5		
Expansion controller	PAC-YG50ECA	6		
BM ADAPTER	BAC-HD150	6		
System controller	AE-200A/AE-50A	0.75		
	EW-50A	1.5		
	LM-AP	0		
Outdoor/Heat source unit		TB3 and TB7 total	TB7 only	TB3 only
	Outdoor unit other than the following units *2	32 *1	6	32*1 - equivalent power supplied to TB7
	S-Series outdoor unit	12 *1	0	12 *1
	TLMU/TKMU outdoor unit	32 *1	- *3	32 *1

\*1 When one or more indoor units listed below is connected, subtract 3 from the equivalent power supply.

Table 3

Category	Model
Indoor unit	Sized P72, P96 PEFY-AF1200CFM(R)-E

\*2 If PAC-SC51KUA is used to supply power at TB7 side, no power supply need from Outdoor/Heat source unit at TB7, Connector TB3 itself will therefore have 32.

With the equivalent power consumption values and the equivalent number of units in Table 1 and Table 2, PAC-SF46EPA-G can be designed into the air-conditioner system to ensure proper system communication according to (A), (B), (C).

- (A) Firstly, count from TB3 at TB3 side the total equivalent number of units of Indoor units, ME remote controller, and System controllers. If the total equivalent number of units reaches 40, a PAC-SF46EPA-G should be set.
- (B) Secondly, count from TB7 side to TB3 side the total transmission power consumption. If the total equivalent power supply reaches 32, a PAC-SF46EPA-G should be set. Yet, if a PAC-SC51KUA or another controller with a built-in power supply, such as PAC-YG50ECA, is used to supply power at TB7 side, count from TB3 side only.
- (C) Thirdly, count from TB7 at TB7 side the total transmission power consumption, If the total equivalent power supply for only TB7 reaches 6, a PAC-SF46EPA-G should be set. Also, count from TB7 at TB7 side the total equivalent number of units of System controllers, and so on. If the total equivalent number of units reaches 40, a PAC-SF46EPA-G should be set.

\* The equivalent power supply of S-Series outdoor unit is 12.

\* When one or more indoor units listed in Table 3 is connected, subtract 3 from the equivalent power supply.

■ System example

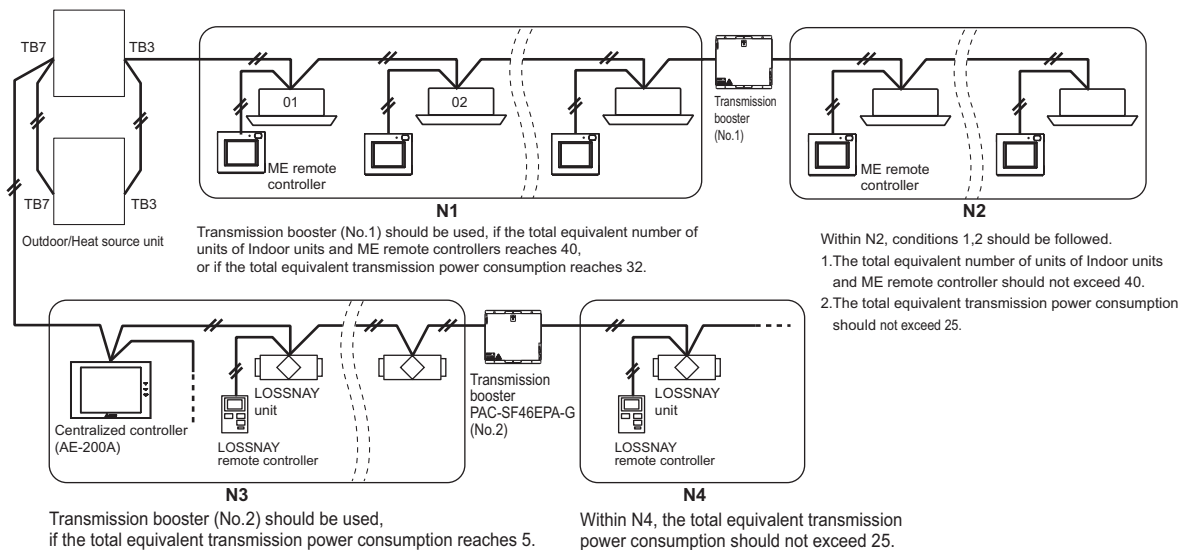

PUHY-HP-T(S)NU-A, Y(S)NU-A

11-3-3. Ensuring proper power supply to System controller

The power to System controller (excluding AE-200A, AE-50A, EW-50A, BAC-HD150) is supplied via M-NET transmission line. M-NET transmission line at TB7 side is called Centralized control transmission line while one at TB3 side is called Indoor-Outdoor/Heat source transmission line. There are 3 ways to supply power to the System controller .

A) Connecting to TB3 of the Outdoor/Heat source unit and receiving power from the Outdoor/Heat source unit.

B) Connecting to TB7 of the Outdoor/Heat source unit and receiving power from the Outdoor/Heat source unit.

(Not applicable to the PUMY model)

C) Connecting to TB7 of the Outdoor/Heat source unit but receiving power from power supply unit PAC-SC51KUA.

\* System controllers (AE-200A, AE-50A, EW-50A, BAC-HD150) have a built-in function to supply power to the M-NET transmission lines, so no power needs to be supplied to the M-NET transmission lines from the Outdoor/Heat source units or from PAC-SC51KUA.

11-3-3-A. When connecting to TB3 of the Outdoor/Heat source unit and receiving power from the Outdoor/Heat source unit.

Maximum 3 System controllers can be connected to TB3. If there is more than 1 Outdoor/Heat source unit, it is necessary to replace power supply switch connector CN41 with CN40 on one Outdoor/Heat source unit.

Fig. 11-3-3-A

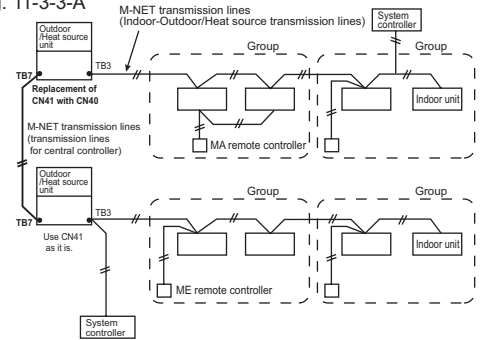

11-3-3-B. When connecting to TB7 of the Outdoor/Heat source unit and receiving power from the Outdoor/Heat source unit. (Not applicable to the PUMY model)

A maximum of 6 system controller are connectable to TB3 and TB7 of Outdoor/Heat source unit.

(Not applicable to the PUMY model)

It is necessary to replace power supply switch connector CN41 with CN40 on one Outdoor/Heat source unit.

Fig. 11-3-3-B

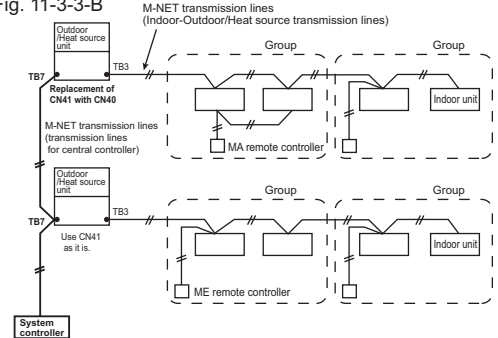

11-3-3-C. When connecting to TB7 of the Outdoor/Heat source unit but receiving power from PAC-SC51KUA.

When using PAC-SC51KUA to supply transmission power, the power supply connector CN41 on the Outdoor/Heat source units should be kept as it is. It is also a factory setting.

1 PAC-SC51KUA supports maximum 1 AG-150A-A or 1 EB-50GU-A unit due to the limited power 24VDC at its TB3.

However, 1 PAC-SC51KUA supplies transmission power at its TB2 equal to 5 Indoor units, which is referable at Table 2.

If System controller, ON/OFF controller connected to TB7 consume transmission power more than 5 (Indoor units), Transmission booster PAC-SF46EPA-G is needed. PAC-SF46EPA-G supplies transmission power equal to 25 Indoor units.

Fig. 11-3-3-C

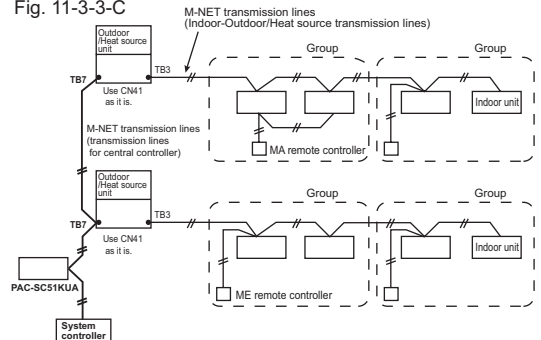

**CAUTION**

- How to connect system controllers (AE-200A, AE-50A, EW-50A, BAC-HD150) to a given system System controllers (AE-200A, AE-50A, EW-50A, BAC-HD150) have a built-in function to supply power to the M-NET transmission lines, so no power needs to be supplied to the M-NET transmission lines from the Outdoor/Heat source units or from PAC-SC51KUA. Leave the power supply connector on the Outdoor/Heat source unit connected to CN41 as it is. Refer to 11-3-2 for information about the power-supply capacity of each system controller (EW-50A, BAC-HD150) to the low-level system controllers.

Fig. 11-3-3-D

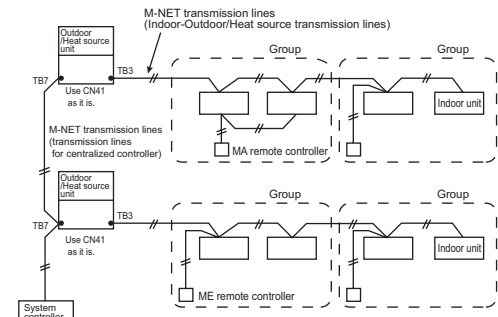



**11-3-4. Power supply to expansion controller**

1-phase 100-240VAC power supply is needed.

The power supply unit PAC-SC51KUA is not necessary.

The expansion controller supplies power through TB3, which equals 6 indoor units. (refer to Table 2)

**11-3-5. Power supply to BM ADAPTER**

1-phase 100-240VAC power supply is needed.

The power supply unit PAC-SC51KUA is not necessary when only BM ADAPTER is connected.

Yet, make sure to move the power jumper from CN41 to CN40 on the BM ADAPTER.

**11-3-6. Power supply to AE-200A/AE-50A/EW-50A**

1-phase 100-240VAC power supply is needed.

The power supply unit PAC-SC51KUA is not necessary when connecting only the AE-200A/AE-50A/EW-50A.

## 11-4. Address setting

### 11-4-1. Switch operation

In order to constitute CITY MULTI in a complete system, switch operation for setting the unit address No. and connection No. is required.

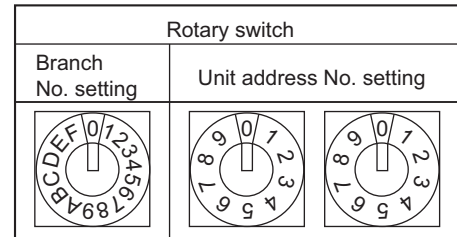

- ① Address No. of outdoor unit, indoor unit and ME remote controller.  
The address No. is set at the address setting board.  
In the case of R2 system, it is necessary to set the same No. at the branch No. switch of indoor unit as that of the BC controller connected. (When connecting two or more branches, use the lowest branch No.)

② Caution for switch operations

- Be sure to shut off power source before switch setting. If operated with power source on, switch can not operate properly.
- No units with identical unit address shall exist in one whole air conditioner system. If set erroneously, the system can not operate.

③ MA remote controller

- When connecting only one remote controller to one group, it is always the main remote controller.  
When connecting two remote controllers to one group, set one remote controller as the main remote controller and the other as the sub remote controller.
- The factory setting is "Main".

PAR-4"x"MAA ("x" represents 0 or later), PAR-CT01MA  
The MA remote controller does not have the switches listed above.  
Refer to the installation manual for the function setting.

#### PAC-YT53CRAU

























##### Setting the dip switches

There are switches on the back of the top case. Remote controller Main/Sub and other function settings are performed using these switches. Ordinarily, only change the Main/Sub setting of SW1.  
(The factory settings are ON for SW1, 3, and 4 and OFF for SW2.)

SW No	SW contents Main	ON	OFF	Comment
1	Remote controller Main/Sub setting	Main	Sub	Set one of the two remote controllers at one group to "ON".
2	Temperature display units setting	Celsius	Fahrenheit	When the temperature is displayed in [Fahrenheit], set to "OFF".
3	Cooling/heating display in AUTO mode	Yes	No	When you do not want to display "Cooling" and "Heating" in the AUTO mode, set to "OFF".
4	Indoor temperature display	Yes	No	When you do not want to display the indoor temperature, set to "OFF".

PUHY-HP-T(S)NU-A, Y(S)NU-A

11-4-2. Rule of setting address

Unit	Address setting	Example	Note
Indoor unit System control interface (MAC-333IF-E) A-M converter (PAC-IF01MNT-E)	01 ~ 50	 	Use the most recent address within the same group of indoor units. Make the indoor units address connected to the BC controller (Sub) larger than the indoor units address connected to the BC controller (Main). If applicable, set the sub BC controllers in an PURY system in the following order: (1) Indoor unit to be connected to the BC controller (Main) (2) Indoor unit to be connected to the BC controller (No.1 Sub) (3) Indoor unit to be connected to the BC controller (No.2 Sub) Set the address so that (1)<(2)<(3)
Outdoor unit	51 ~ 99, 100 (Note1)	 	The smallest address of indoor unit in same refrigerant system + 50 Assign sequential address numbers to the outdoor units in one refrigerant circuit system. OC and OS are automatically detected. (Note 2) *Please reset one of them to an address between 51 and 99 when two addresses overlap. *The address automatically becomes "100" if it is set as "01~ 50"
BC controller (Main)	52 ~ 99, 100	 	The address of outdoor unit + 1 *Please reset one of them to an address between 51 and 99 when two addresses overlap. *The address automatically becomes "100" if it is set as "01~ 50"
BC controller (Sub)	52 ~ 99, 100	 	Lowest address within the indoor units connected to the BC controller (Sub) plus 50.
Local remote controller	ME, LOSSNAY Remote controller (Main)	1 Fixed  	The smallest address of indoor unit in the group + 100 *The place of "100" is fixed to "1"
	ME, LOSSNAY Remote controller (Sub)	1 Fixed  	The address of main remote controller + 50 *The address automatically becomes "200" if it is set as "00"
System controller	ON/OFF remote controller	  	The smallest group No. to be managed + 200 * The smallest group No. to be managed is changeable.
	AE-200A/AE-50A AG-150A-A EB-50GU-A EW-50A TC-24B	0, 2    0-5    0-9 100    10    1	* TC-24B cannot be set to "000".
	PAC-YG50ECA	0, 2    0-5    0-9 100    10    1	* Settings are made on the initial screen of AG-150A-A.
	BAC-HD150	0, 2    0-5    0-9 100    10    1	* Settings are made with setting tool of BM ADAPTER.
PI, AI, DIDO	PAC-YG60MCA	 	
	PAC-YG63MCA	 	
	PAC-YG66DCA	 	
LOSSNAY	01 ~ 50	 	After setting the addresses of all the indoor units, assign an arbitrary address.
PAC-IF01AHC-J	201 ~ 250	2 Fixed  	

Note1: To set the address to "100", set it to "50"

Note2: Outdoor units OC and OS in one refrigerant circuit system are automatically detected.  
OC and OS are ranked in descending order of capacity. If units are the same capacity, they are ranked in ascending order of their address.

11-4-3. System examples

Factory setting

Original switch setting of the outdoors, indoors, controllers, and BM ADAPTER at shipment is as follows.

- Outdoor unit : Address: 00, CN41: ON (Jumper), DipSW5-1: OFF
- Indoor unit : Address: 00
- ME remote controller : Address: 101
- BM ADAPTER : Address: 000, CN41: ON (Jumper)

Setting at the site

- DipSW5-1 (Outdoor) : When the System Controller is used, all the Dip SW5-1 at the outdoor units should be set to "ON".
- CN40/CN41 : Change jumper from CN41 to CN 40 at outdoor control board will activate central transmission power supply to TB7;  
(Change jumper at only one outdoor unit when activating the transmission power supply without using a power supply unit.)  
Power supply unit is recommended to use for a system having more than 1 outdoor unit, because the central transmission power supply from TB7 of one of outdoor units is risking that the outdoor unit failure may let down the whole system controller system.

11-4-3-1. MA remote controller, Single-refrigerant-system, No System Controller

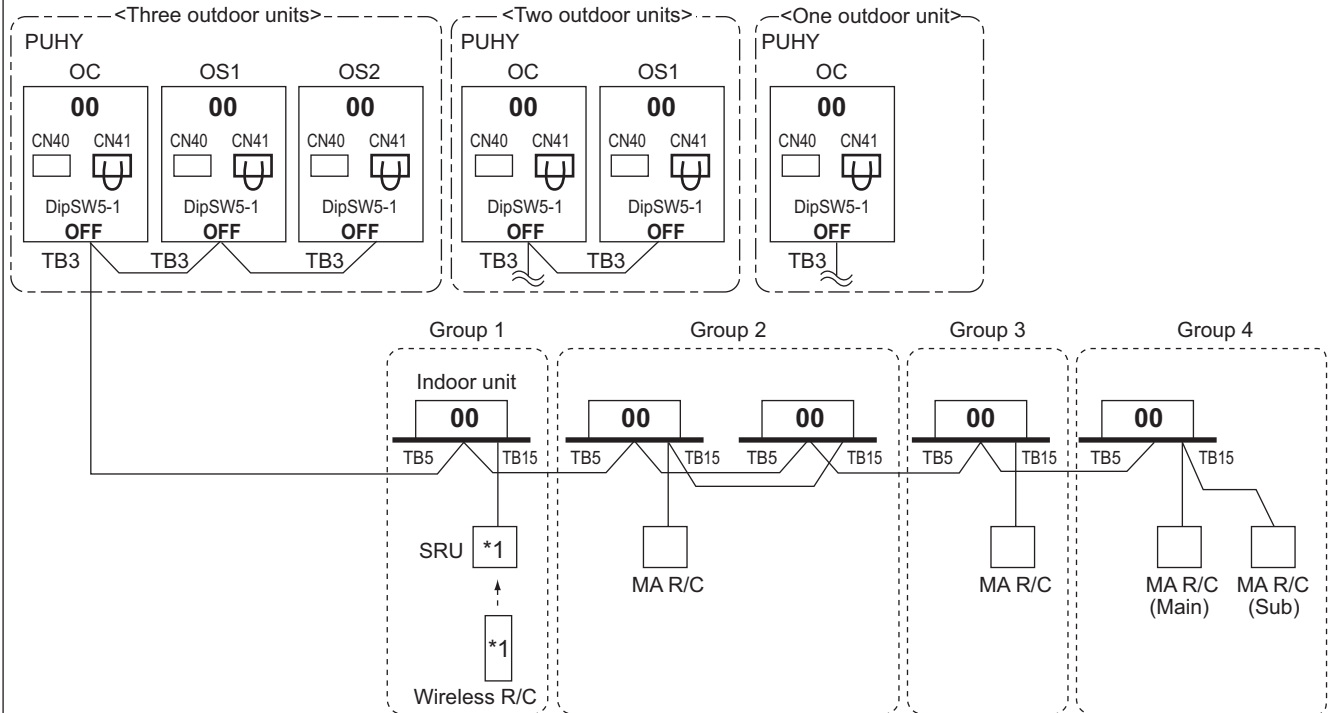

\*1 For Wireless R/C and Signal receiver unit (SRU), channel 1, 2 and 3 are selectable and should be set to same channel.

NOTE:

1. Outdoor units OC, OS1 and OS2 in one refrigerant circuit system are automatically detected.  
OC, OS1 and OS2 are ranked in descending order of capacity. If units are the same capacity, they are ranked in ascending order of their address.
2. No address setting is needed.
3. For a system having more than 32 indoor unit, confirm the need of Booster at 11-3. "System configuration restrictions".
4. When the PAR-CT01MA series, PAR-FS01MA series, PAR-4"x"MA series, or PAR-3"x"MA series ("x" represents 0 or later) is connected to a group, no other MA remote controllers can be connected to the same group.

11-4-3-2. MA remote controller, Single-refrigerant-system, System Controller

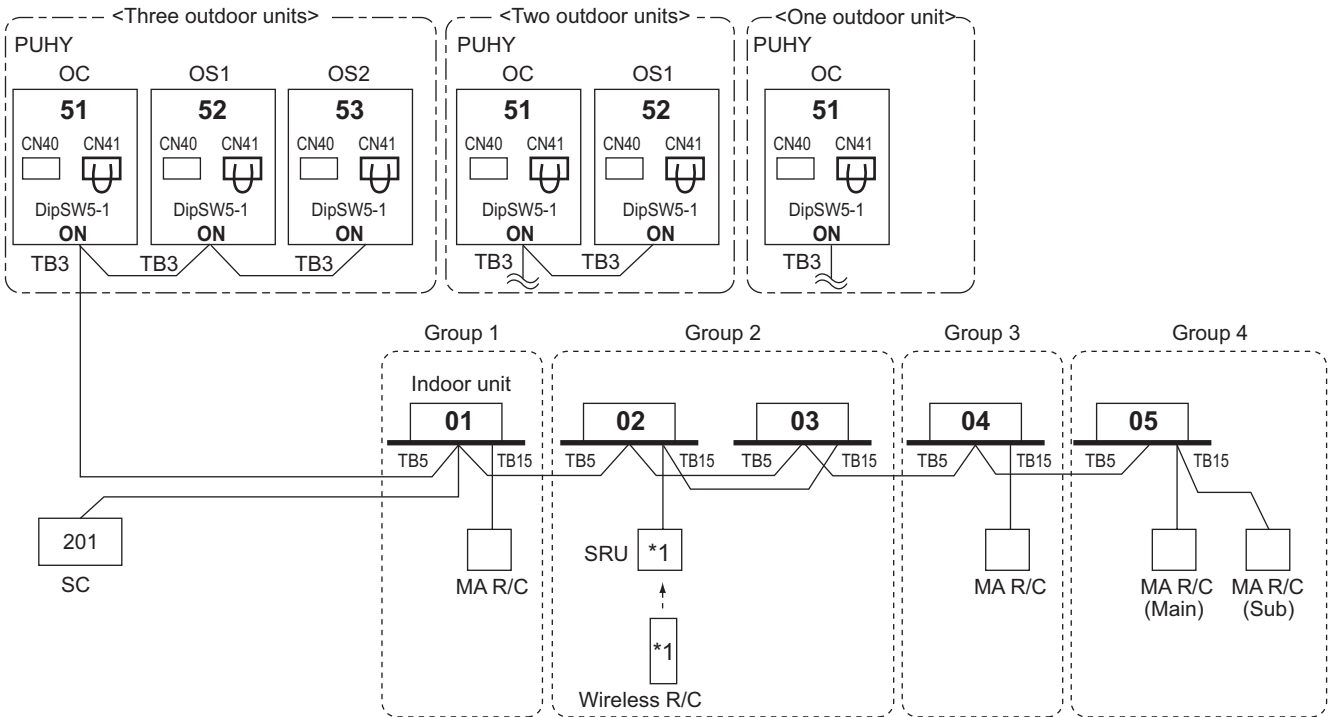

\*1 For Wireless R/C and Signal receiver unit (SRU), channel 1, 2 and 3 are selectable and should be set to same channel.  
 \*SC can be connected to TB3 side or TB7 side;  
 Should SC connected to TB7 side, change Jumper from CN41 to CN40 at the Outdoor unit module so as to supply power to the SC.  
 Up to three System controllers can be connected to TB3 side.

NOTE:

1. Outdoor units OC, OS1 and OS2 in one refrigerant circuit system are automatically detected.  
 OC, OS1 and OS2 are ranked in descending order of capacity. If units are the same capacity, they are ranked in ascending order of their address.
2. Address should be set to Indoor units and central controller.
3. For a system having more than 32 indoor unit, confirm the need of Booster at 11-3. **"System configuration restrictions"**.
4. When the PAR-CT01MA series, PAR-FS01MA series, PAR-4"x"MA series, or PAR-3"x"MA series ("x" represents 0 or later) is connected to a group, no other MA remote controllers can be connected to the same group.

11-4-3-3. MA remote controller, Multi-refrigerant-system, System Controller at TB7/TB3 side, Booster for long M-NET wiring

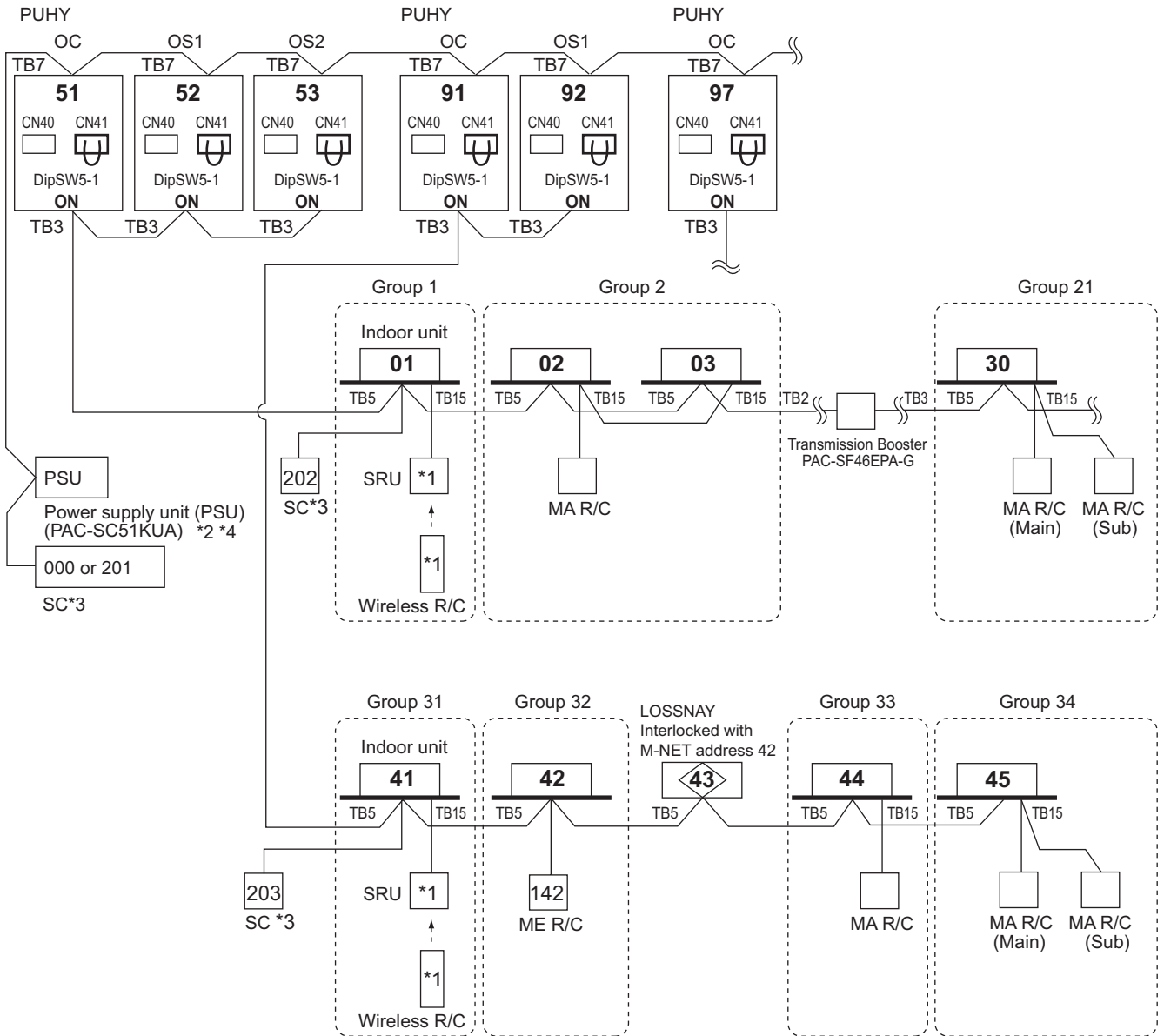

\*1 For Wireless R/C and Signal receiver unit (SRU), channel 1, 2 and 3 are selectable and should be set to same channel.  
 \*2 System controller should connect to TB7 at Outdoor and use power supply unit together in Multi-Refrigerant-System. For AG-150A-A, 24VDC should be used with the PAC-SC51KUA. For AE-200A, AE-50A, and EW-50A the power supply unit PAC-SC51KUA is unused.  
 \*3 When multiple system controllers are connected in the system, set the controller with more functions than others as a "main" controller and others as "sub". AE-200A, AE-50A, EW-50A, and BAC-HD150 are for exclusive use as a "main" system controller and cannot be used as a "sub" system controller. Make the setting to only one of the system controllers for "prohibition of operation from local remote controller".  
 \*4 The power supply unit is not necessary for AE-200A, AE-50A, EW-50A, and BAC-HD150.

- NOTE:
- Outdoor units OC, OS1 and OS2 in one refrigerant circuit system are automatically detected. OC, OS1 and OS2 are ranked in descending order of capacity. If units are the same capacity, they are ranked in ascending order of their address.
  - Address should be set to Indoor units, LOSSNAY and system controller.
  - M-NET power is supplied by the Outdoor unit at TB3, while Indoor unit and ME remote controller consume the M-NET power for transmission use. The power balance is needed to consider for long M-NET wiring. Details refer to 11-3. "System configuration restrictions".
  - When the PAR-CT01MA series, PAR-FS01MA series, PAR-4"x"MA series, or PAR-3"x"MA series ("x" represents 0 or later) is connected to a group, no other MA remote controllers can be connected to the same group.



PUHY-HP-T(S)NU-A, Y(S)NU-A

11-4-3-4. ME remote controller, Single-refrigerant-system, No system controller

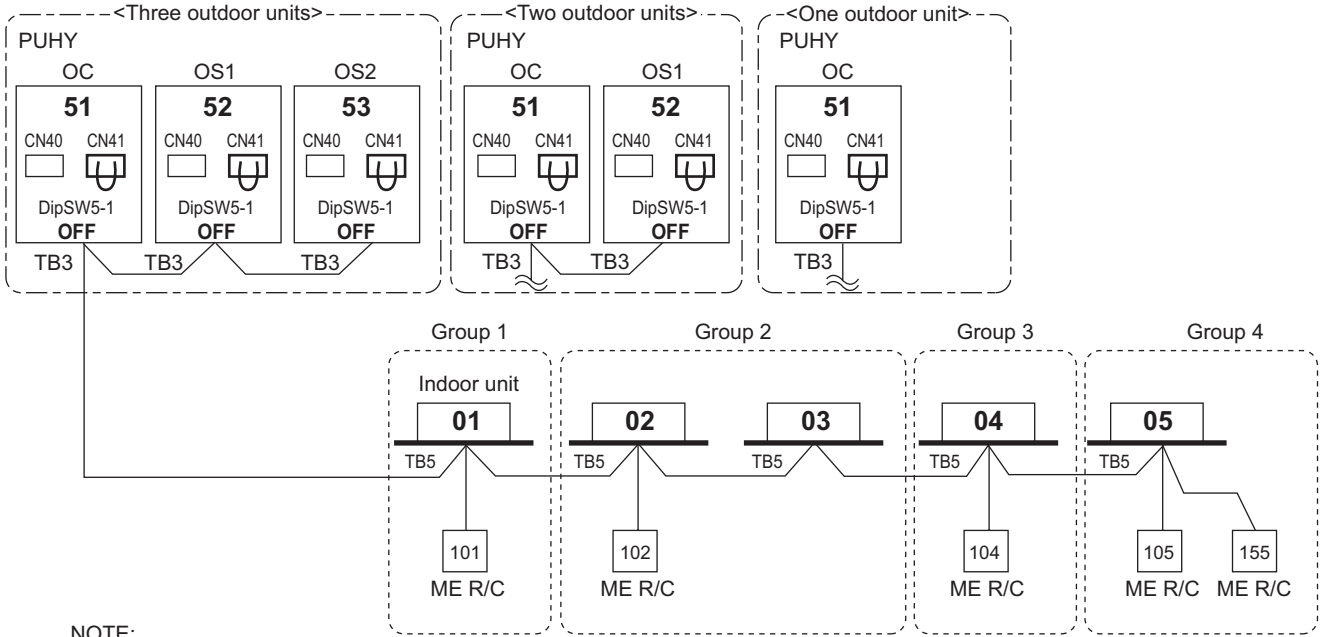

NOTE:

- Outdoor units OC, OS1 and OS2 in one refrigerant circuit system are automatically detected. OC, OS1 and OS2 are ranked in descending order of capacity. If units are the same capacity, they are ranked in ascending order of their address.
- Address should be set to Indoor units, system controller and ME remote controllers.
- M-NET power is supplied by the Outdoor unit at TB3, while Indoor unit and ME R/C consume the M-NET power for transmission use. The power balance is needed to consider for long M-NET wiring. Details refer to 11-3. "System configuration restrictions".

11-4-3-5. ME remote controller, Single-refrigerant-system, System controller, LOSSNAY

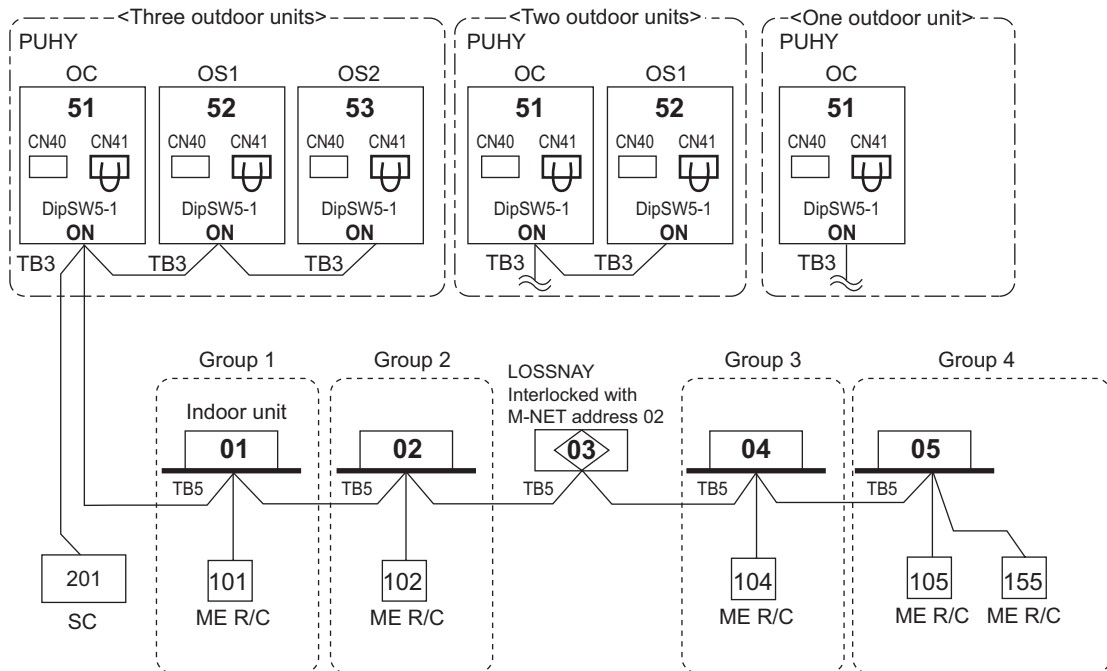

\*SC can be connected to TB3 side or TB7 side;  
Should SC connected to TB7 side, change Jumper from CN41 to CN40 at the Outdoor unit module so as to supply power to the SC.  
Up to three System controllers can be connected to TB3 side.

NOTE:

- Outdoor units OC, OS1 and OS2 in one refrigerant circuit system are automatically detected. OC, OS1 and OS2 are ranked in descending order of capacity. If units are the same capacity, they are ranked in ascending order of their address.
- Address should be set to Indoor units, LOSSNAY, central controller, and ME remote controllers.
- For a system having more than 32 indoor unit, confirm the need of Booster at 11-3. "System configuration restrictions".

11-4-3-6. ME remote controller, Multi-refrigerant-system, System Controller at TB7 side, LOSSNAY, Booster for long M-NET wiring

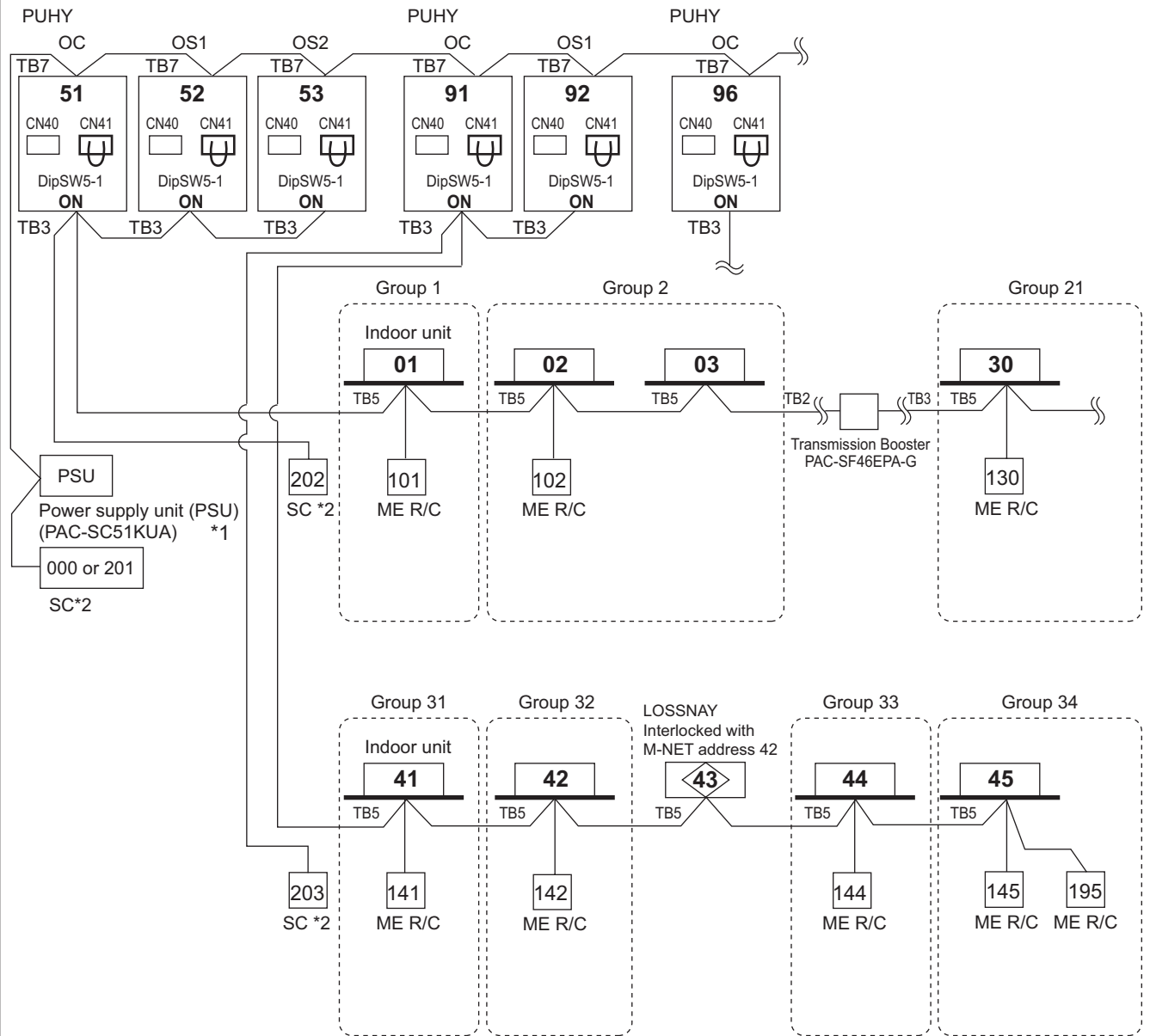

\*1 System controller should connect to TB7 at Outdoor and use power supply unit together in Multi-Refrigerant-System. For AG-150A-A, 24V DC should be used with the PAC-SC51KUA.

\*2 When multiple system controllers are connected in the system, set the controller with more functions than others as a "main" controller and others as "sub".  
 TC-24A, AG-150A-A, AE-200A, AE-50A, EW-50A, and BAC-HD150 are for exclusive use as a "main" system controller and cannot be used as a "sub" system controller.  
 Make the setting to only one of the system controllers for "prohibition of operation from local remote controller".

NOTE:

- Outdoor units OC, OS1 and OS2 in one refrigerant circuit system are automatically detected. OC, OS1 and OS2 are ranked in descending order of capacity. If units are the same capacity, they are ranked in ascending order of their address.
- M-NET power is supplied by the Outdoor unit at TB3, while Indoor unit and ME remote controller consume the M-NET power for transmission use. The power balance is needed to consider for long M-NET wiring. Details refer to 11-3. "System configuration restrictions".

11-4-3-7. AE-200A + AE-50A, EW-50A

AE-200A can control max. 200 indoor units/via AE-50A.

PUHY-HP-T(S)NU-A, Y(S)NU-A

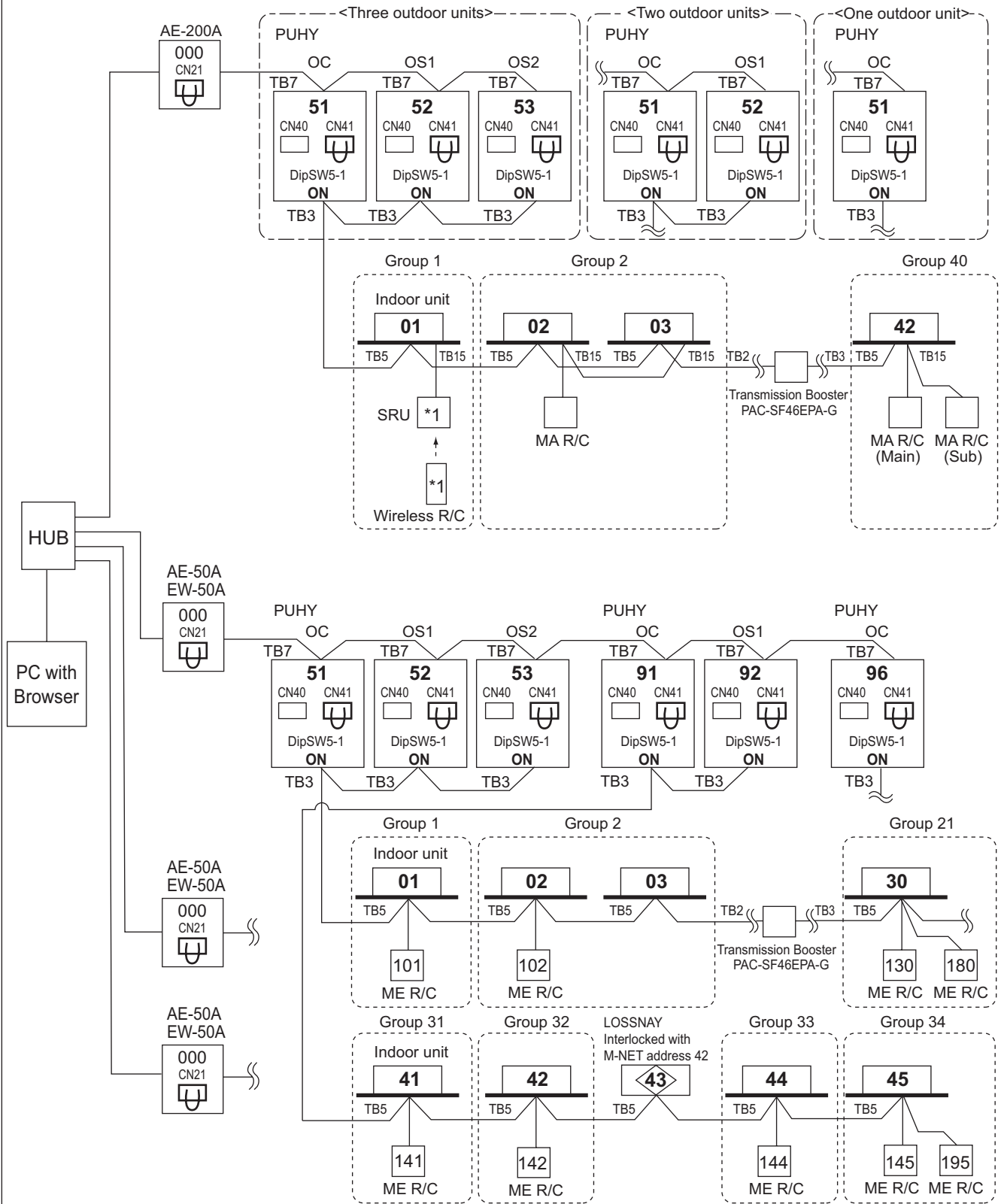

\*1 For Wireless R/C and Signal receiver unit (SRU), channel 1, 2 and 3 are selectable and should be set to same channel.

\*2 When the PAR-CT01MA series, PAR-FS01MA series, PAR-4"x"MA series, or PAR-3"x"MA series ("x" represents 0 or later) is connected to a group, no other MA remote controllers can be connected to the same group.

11-4-3-8. BACnet®

EW-50A (AE-200A) can control up to 50 units/groups (including LOSSNAY).

\*To use the BACnet® function on EW-50A (AE-200A), BACnet® license registration is required.

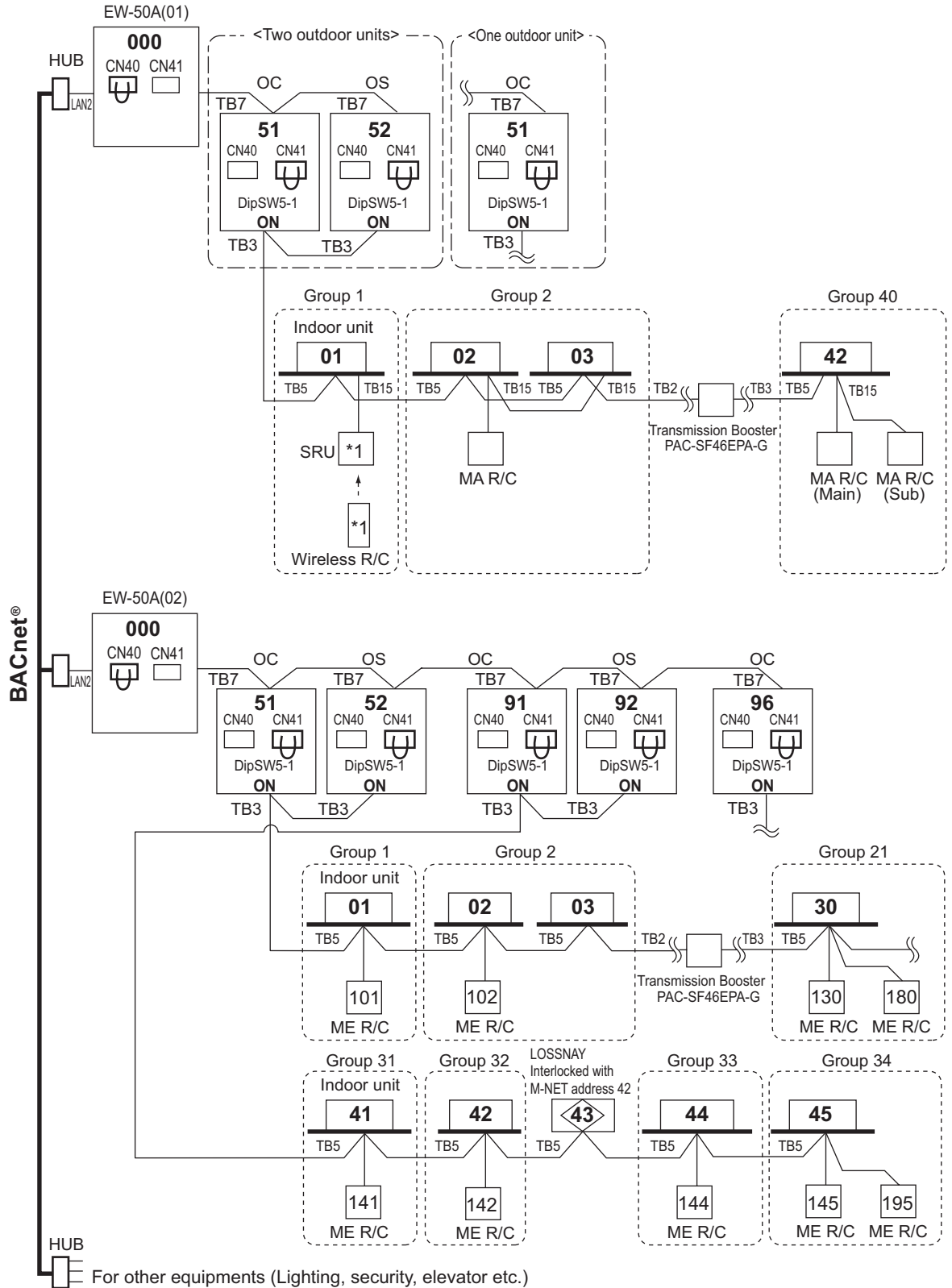

\*1 For Wireless R/C and Signal receiver unit (SRU), channel 1, 2 and 3 are selectable and should be set to same channel.

\*2 When the PAR-CT01MA series, PAR-FS01MA series, PAR-4"x"MA series, or PAR-3"x"MA series ("x" represents 0 or later) is connected to a group, no other MA remote controllers can be connected to the same group.

12-1. R410A Piping material

Refrigerant pipe for CITY MULTI shall be made of phosphorus deoxidized copper, and has two types.

A. Type-O: Soft copper pipe (annealed copper pipe), can be easily bent with human's hand.

B. Type-1/2H pipe: Hard copper pipe (Straight pipe), being stronger than Type-O pipe of the same radical thickness.

The maximum operation pressure of R410A air conditioner is 4.30 MPa [623psi]. The refrigerant piping should ensure the safety under the maximum operation pressure. MITSUBISHI ELECTRIC recommends pipe size as Table1, or You shall follow the local industrial standard. Pipes of radical thickness 0.7mm or less shall not be used.

Table 1. Copper pipe size and radial thickness for R410A CITY MULTI.

Size (mm)	Size (in.)	Radial thickness (mm)	Radial thickness (mil)	Pipe type
ø6.35	ø1/4"	0.8	[32]	Type-O
ø9.52	ø3/8"	0.8	[32]	Type-O
ø12.7	ø1/2"	0.8	[32]	Type-O
ø15.88	ø5/8"	1.0	[40]	Type-O
ø19.05	ø3/4"	1.2	[48]	Type-O
ø19.05	ø3/4"	1.0	[40]	Type-1/2H or H
ø22.2	ø7/8"	1.0	[40]	Type-1/2H or H
ø25.4	ø1"	1.0	[40]	Type-1/2H or H
ø28.58	ø1-1/8"	1.0	[40]	Type-1/2H or H
ø31.75	ø1-1/4"	1.1	[44]	Type-1/2H or H
ø34.93	ø1-3/8"	1.2	[48]	Type-1/2H or H
ø41.28	ø1-5/8"	1.4	[56]	Type-1/2H or H

\* For pipe sized ø19.05 (3/4") for R410A air conditioner, choice of pipe type is up to you.

\* The figures in the radial thickness column are based on the Japanese standards and provided only as a reference. Use pipes that meet the local standards.

Flare

Due to the relative higher operation pressure of R410A compared to R22, the flare connection should follow dimensions mentioned below so as to achieve enough the air-tightness.

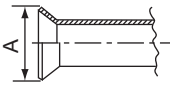
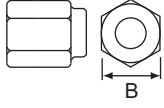
Flare pipe	Pipe size	A (For R410A)	(mm[in.])	Flare nut	Pipe size	B (For R410A)	(mm[in.])
	ø6.35 [1/4"]	9.1			ø6.35 [1/4"]	17.0	
	ø9.52 [3/8"]	13.2			ø9.52 [3/8"]	22.0	
	ø12.70 [1/2"]	16.6			ø12.70 [1/2"]	26.0	
	ø15.88 [5/8"]	19.7			ø15.88 [5/8"]	29.0	
	ø19.05 [3/4"]	24.0			ø19.05 [3/4"]	36.0	

PUHY-HP-T(S)NU-A, Y(S)NU-A

**Procedures for installing the branched pipes**

Refer to the instructions that came with the branched pipe kit (separately sold) for details.

[1] Branches on the indoor-unit side

**Joint**

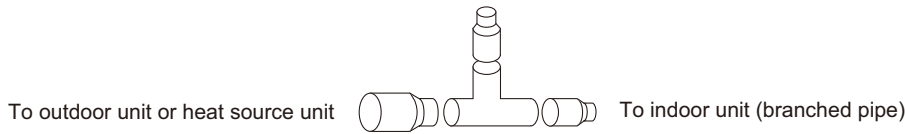

**Horizontal installation**

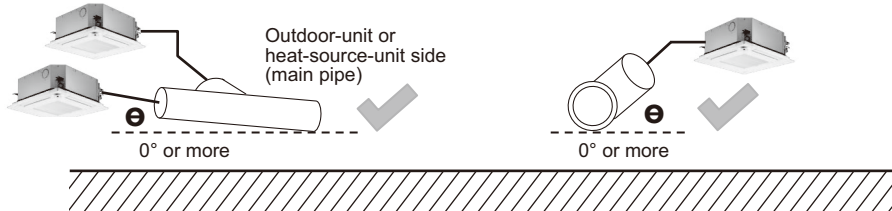

**Be careful on return oil.**



**Vertical installation**

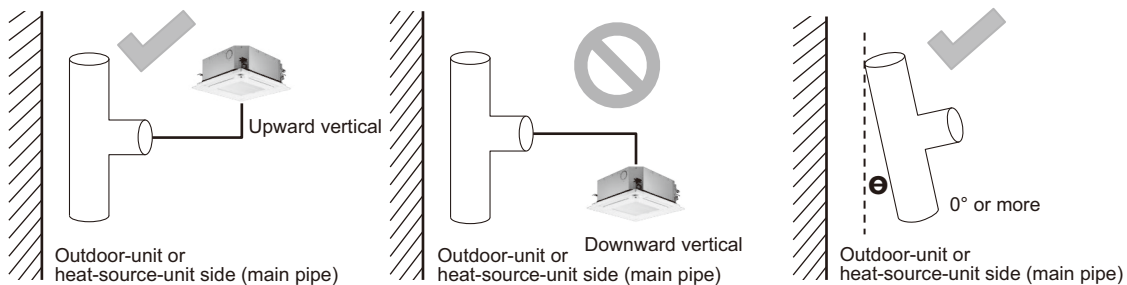

- Restrictions described here apply to the joint in the gas line.
- CMY-Y202S-G2 or CMY-Y302S-G2 in the gas line must be installed horizontally (see figure above) or with the branched pipes facing up.
- If the size of the refrigerant pipe that is selected by following the instructions under “Piping Design” section does not match the size of the joint, use a reducer to connect them. A reducer is included in the kit.

**Header**

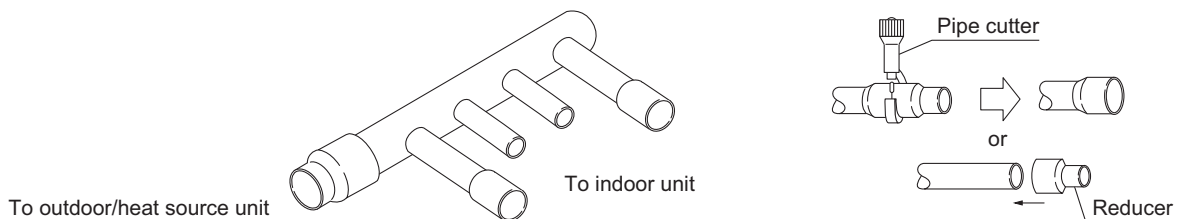

- No restrictions apply to the installation of the header.
- If the size of the refrigerant pipe that is selected by following the instructions under “Piping Design” section does not match the size of the header, cut the pipe to an appropriate size using a pipe cutter, or use a reducer to connect them.
- If the number of header branches exceeds the number of pipes to be connected, cap the unused header branches. Caps are included in the kit.

[2] Branches on the outdoor/heat source-unit side

Note. Refer to the figure below for the installation position of the twinning pipe.

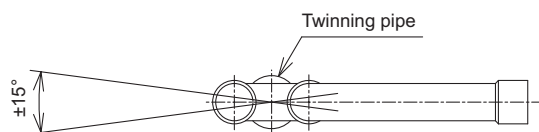

Slope of the twinning pipes are at an angle within  $\pm 15^\circ$  to the horizontal plane.

- Inclination of the twinning pipes  
The inclination of the twinning pipes must be  $\pm 15^\circ$  or less against the horizontal plane. Excessive inclination of the twinning pipes may damage the unit.
- Minimum length of the straight section of the pipe before the twinning pipes  
Always use the pipes supplied in the twinning pipe kit, and make sure the straight section of the pipe immediately before it connects to the twinning pipe is at least 500 mm (19-11/16 in.). Failure to do so may damage the unit.



## 12-2. Piping Design

## Rule for piping size selection

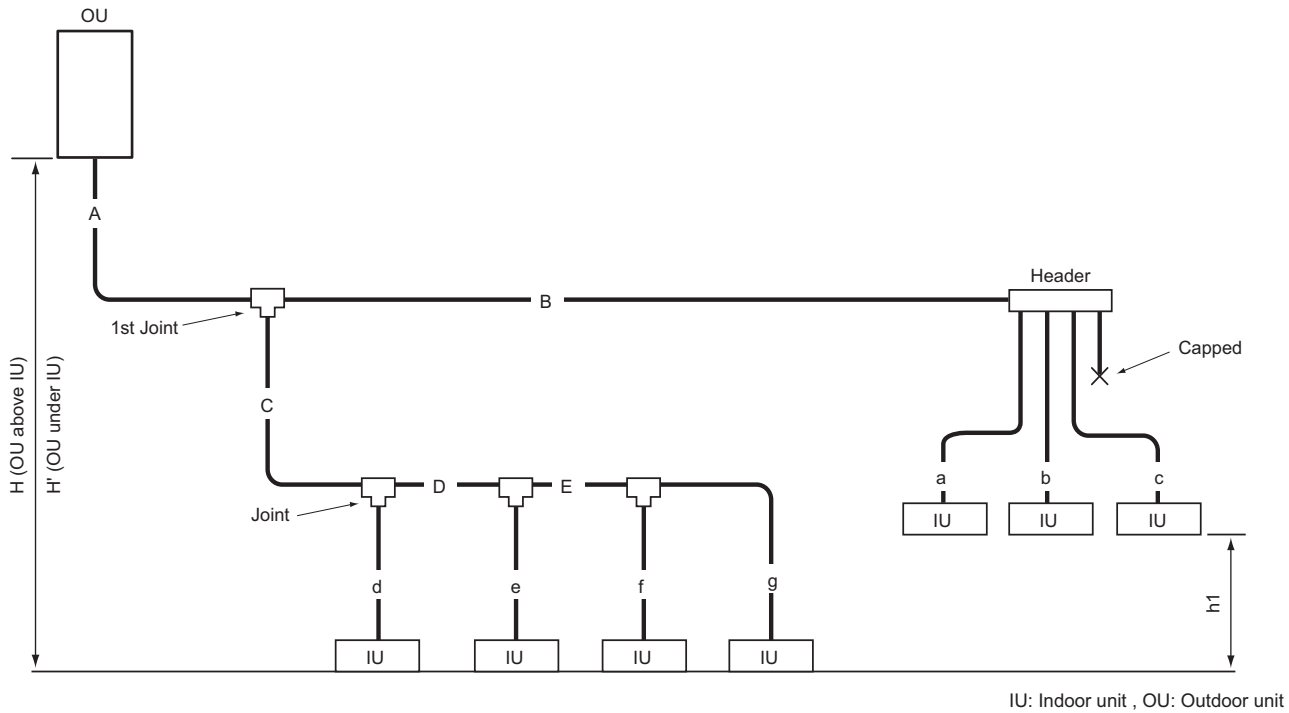

## 1. Selecting joints

Select joints from Table 4-1 [Selection criteria for joints] based on the total capacity of indoor units on the downstream side.

When selecting the first joint for the system to which the outdoor unit listed in Table 4-2 [See the table below for the first joint of the outdoor unit described below.] is connected, select the first joint from Table 4-2.

## 2. Selecting headers

Select headers from Table 5 [Header selection rule] based on the number of indoor units to be connected.

Refer to Table 5, which shows the total capacity limits, for the indoor units to be connected on the downstream side.

When connecting a header directly to the outdoor unit, select the header by referring to the notes in Table 5.

\*The piping cannot be branched on the downstream of the header.

## 3. Selecting refrigerant pipe sizes

## (1) Between outdoor unit and the 1st joint [A]

Select the appropriate size pipes for the selected outdoor unit from Table 1 [Piping "A" size selection rule].

## (2) Between joints [B, C, D, and E]

Select the appropriate size pipes from Table 2 [Piping "B", "C", "D", ... size selection rule] based on the total capacity of indoor units on the downstream side.

## (3) Between joints and indoor units [a, b, c, d, e, f, and g]

Select the appropriate size pipes from Table 3 [Piping "a", "b", "c", "d", ... size selection rule] based on the capacity of indoor units.

## (4) After selecting the pipe sizes in accordance with steps (1) through (3) above, if the size of the pipes on the downstream is larger than that on the upstream, it is not necessary to be bigger than the upstream one.

## (5) If any of the following applies to the selection made in Item 3-(1)-(4) above, reselect the pipe size.

(Not applicable to some models)

(a) If the length of the pipe to any indoor unit from the first joint exceeds 40 m [131 ft.], use one size larger liquid pipe after the joint that is located before the point where the pipe length exceeds 40 m [131 ft.].

(b) Set indoor unit(s) which is vertically closer to the outdoor unit as "base unit(s)".

Only the indoor units that have a height difference of more than 15 m [49 ft.] from base unit will be termed "Target units".

Use one size larger liquid pipe from the target units to the joint prior to which 15 m [49 ft.] height difference has exceeded.

(Not applicable to the liquid pipes whose sizes were increased under item (5)-(a)).

## (6) Calculate the amount of refrigerant to be added based on the pipe sizes selected in Items 1 through 3-(5) above, and make sure that the total amount of the initial charge and the additional charge combined will not exceed the maximum allowable refrigerant charge amount.

If this amount exceeds the maximum allowable amount, redesign the system (i.e., piping length) so that the total refrigerant charge will not exceed the maximum allowable amount.

12-2-1. PUHY-HP72-120TNU/YNU Piping

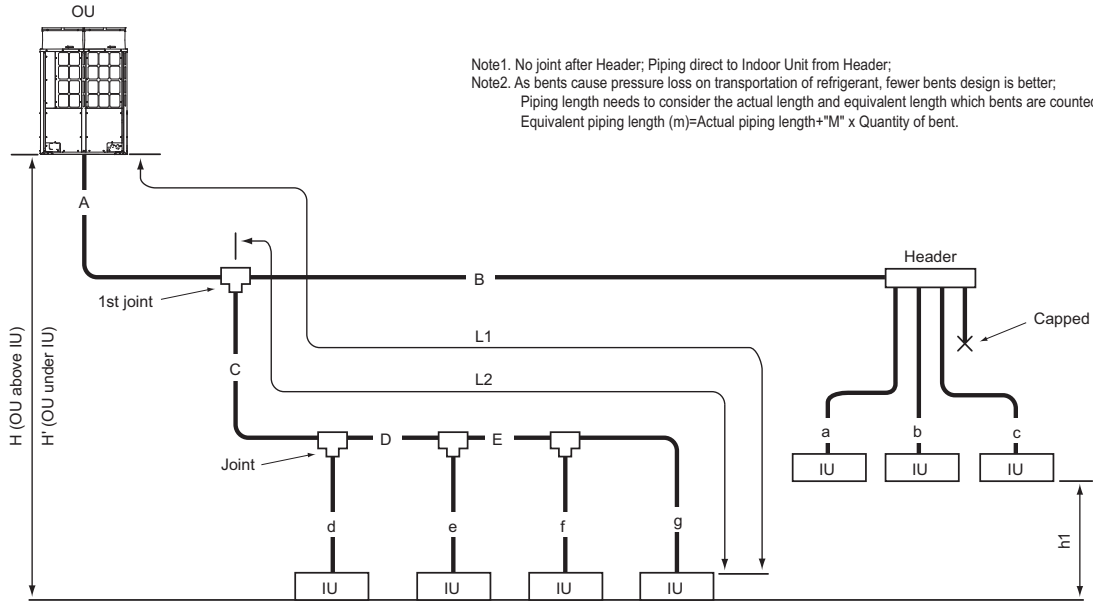

Note1. No joint after Header; Piping direct to Indoor Unit from Header;  
 Note2. As bents cause pressure loss on transportation of refrigerant, fewer bents design is better;  
 Piping length needs to consider the actual length and equivalent length which bents are counted.  
 Equivalent piping length (m)=Actual piping length\**M* \* Quantity of bent.

Fig. 12-2-1A Piping scheme

IU : Indoor unit , OU : Outdoor unit

Piping length Item	Piping in the figure	(m [ft.])		Bent equivalent length "M"	
		Max. length	Max. equivalent length	Outdoor Model	M (m/bent [ft./bent])
Total piping length	A+B+C+D+E+a+b+c+d+e+f+g	1000 [3280]	-	PUHY-HP72T/YNU	0.35 [1.15]
Farthest IU from OU (L1)	A+C+D+E+g / A+B+c	165 [541]	190 [623]	PUHY-HP96T/YNU	0.42 [1.38]
Farthest IU from the first joint (L2)	C+D+E+g / B+c	40 [131] *3	40 [131]	PUHY-HP120T/YNU	0.42 [1.38]
Height between OU and IU (OU above IU)	H	50 [164] *1	-		
Height between OU and IU (OU under IU)	H'	40 [131] *2	-		
Height between IU and IU	h1	15 [49] *4	-		

OU: Outdoor Unit, IU: Indoor Unit

\*1 90 m [295 ft.] is available depending on the model and installation conditions. For more detailed information, contact your local distributor.

\*2 60 m [197 ft.] is available depending on the model and installation conditions. For more detailed information, contact your local distributor.

\*3 90 m [295 ft.] is available. When the piping length exceeds 40 m [131 ft.], use one size larger liquid pipe starting with the section of piping where 40 m [131 ft.] is exceeded and all piping after that point.

In the figure above, if the piping labeled "E" exceeds 40 m [131 ft.] (but does not exceed 90 m [295 ft.]), increase the size of the liquid piping labeled E, f, and g by one size.

\*4 30 m [98 ft.] is available. If the height difference between indoor units exceeds 15 m [49 ft.] (but does not exceed 30 m [98 ft.]), use one-size larger pipes for indoor unit liquid pipes.

In the figure above, if "h1" exceeds 15 m [49 ft.], increase the size of the liquid piping labeled d, e, f, and g by one size.

Table1. Piping "A" size selection rule (mm [in.])

Outdoor unit	Pipe(Liquid)	Pipe(Gas)
PUHY-HP72T/YNU	ø9.52 [3/8]	ø22.2 [7/8]
PUHY-HP96T/YNU	ø9.52 [3/8] *1	ø22.2 [7/8]
PUHY-HP120T/YNU	ø9.52 [3/8] *2	ø28.58 [1-1/8]

\*1. L1>=90 m [295 ft.], ø12.70 mm [1/2 in.]; L1<90m [295ft.], ø9.52mm [3/8in.]

\*2. L1>=40 m [131 ft.], ø12.70 mm [1/2 in.]; L1<40m [131ft.], ø9.52mm [3/8in.]

Table4-1. Selection criteria for joints

Total down-stream Indoor capacity	Joint
~ P72	CMY-Y102SS-G2
P73 ~ P144	CMY-Y102LS-G2
P145 ~ P240	CMY-Y202S-G2
P241 ~	CMY-Y302S-G2

\*Concerning detailed usage of joint parts, refer to its Installation Manual.

Table4-2.

See the table below for the first joint of the outdoor unit described below.

Outdoor unit model	Joint model
HP72 to HP120	CMY-Y102LS-G2

Table2. Piping "B", "C", "D", "E" size selection rule (mm [in.])

Total down-stream Indoor capacity	Pipe(Liquid)	Pipe(Gas)
~ P54	ø9.52 [3/8]	ø15.88 [5/8]
P55 ~ P72	ø9.52 [3/8]	ø19.05 [3/4]
P73 ~ P108	ø9.52 [3/8]	ø22.20 [7/8]
P109 ~ P144	ø12.70 [1/2]	ø28.58 [1-1/8]
P145 ~ P240	ø15.88 [5/8]	ø28.58 [1-1/8]
P241 ~ P308	ø19.05 [3/4]	ø34.93 [1-3/8]
P309 ~	ø19.05 [3/4]	ø41.28 [1-5/8]

Table3. Piping "a", "b", "c", "d", "e", "f", "g" size selection rule (mm [in.])

Indoor Unit size	Pipe(Liquid)	Pipe(Gas)
P04 ~ P18	ø6.35 [1/4]	ø12.70 [1/2]
P24 ~ P54	ø9.52 [3/8]	ø15.88 [5/8]
P72	ø9.52 [3/8]	ø19.05 [3/4]
P96	ø9.52 [3/8]	ø22.20 [7/8]

Table5. Header selection rule

Total down-stream Indoor capacity	4-branch Header	8-branch Header	10-branch Header
	<=P72	CMY-Y104C-G	CMY-Y108C-G

\* CMY-Y104C-G can directly connect PUHY-HP72T/YNU, but can NOT directly connect PUHY-HP96T/YNU or above;

\* CMY-Y108C-G can directly connect PUHY-HP72-144T/Y(S)NU, but can NOT directly connect PUHY-HP192T/Y(S)NU or above;

\* CMY-Y1010C-G can directly connect PUHY-HP72-240T/Y(S)NU;

\* CMY-Y104C-G can NOT connect P72~P96 Indoor, but CMY-Y108, Y1010C-G can do;

\* Concerning detailed usage of Header parts, refer to its Installation Manual.

Note3. Indoor capacity is described as its model size;

For example, PEFY-P06NMAU-E3, its capacity is P06;

Note4. Total down-stream Indoor capacity is the summary of the model size of Indoors downstream.

For example, PEFY-P06NMAU-E3+PEFY-P08NMAU-E3: Total Indoor capacity=P06+P08=P14

Note5. Piping size determined by the Total down-stream indoor capacity is NOT necessary

to be bigger than the up-stream one.

i.e. A>=B; A>=C>=D

PUHY-HP-T(S)NU-A, Y(S)NU-A

12-2-2. PUHY-HP144-240TSNU/YSNU Piping

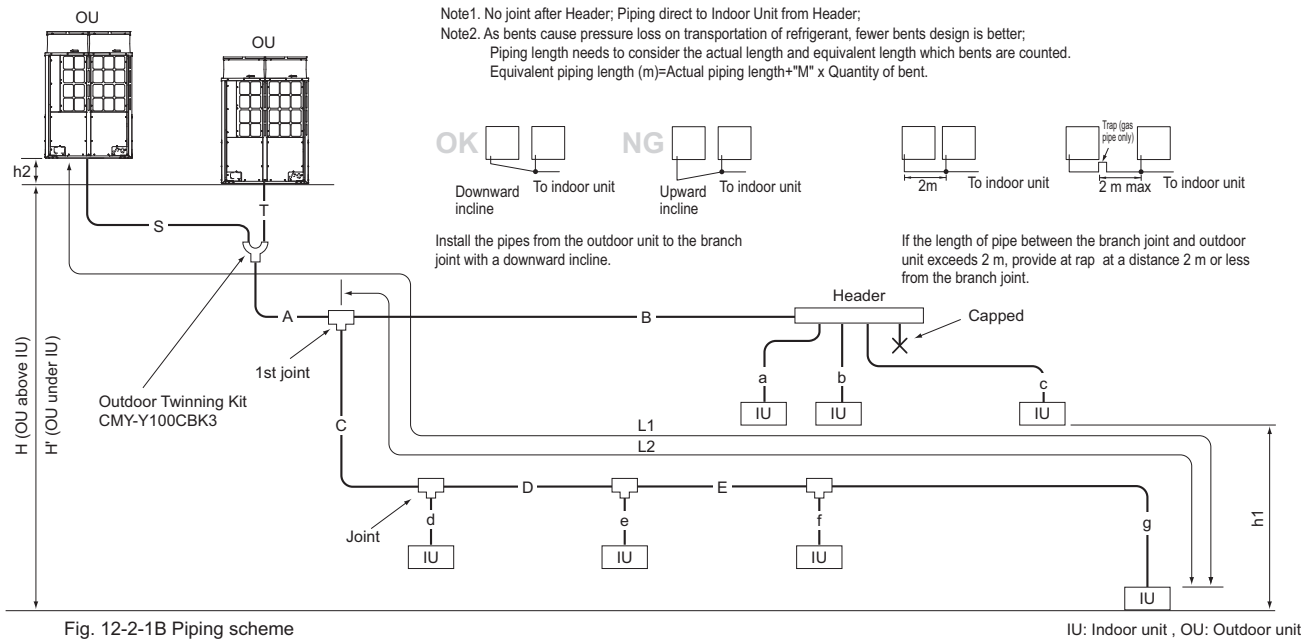

Fig. 12-2-1B Piping scheme

Piping length		(m [ft.])
Item	Piping in the figure	Max. length Max. equivalent length
Total piping length	S+T+A+B+C+D+E+a+b+c+d+e+f+g	1000 [3280] -
Distance between OU and OU	S+T	10[32] -
Height between OU and OU	h2	0.1[0.3] -
Farthest IU from OU (L1)	S(T)+A+C+D+E+g / S(T)+A+B+c	165 [541] 190 [623]
Farthest IU from the first joint (L2)	C+D+E+g / B+c	40 [131] *3 40 [131]
Height between OU and IU (OU above IU)	H	50 [164] *1 -
Height between OU and IU (OU under IU)	H'	40 [131] *2 -
Height between IU and IU	h1	15 [49] *4 -

Bends equivalent length "M"	
Outdoor Model	M (m/bent [ft./bent])
PUHY-HP144T/YSNU	0.50 [1.64]
PUHY-HP192T/YSNU	0.50 [1.64]
PUHY-HP240T/YSNU	0.50 [1.64]

OU: Outdoor Unit, IU: Indoor Unit  
 \*1 90 m [295 ft.] is available depending on the model and installation conditions. For more detailed information, contact your local distributor.  
 \*2 60 m [197 ft.] is available depending on the model and installation conditions. For more detailed information, contact your local distributor.  
 \*3 90 m [295 ft.] is available. When the piping length exceeds 40m [131ft], use one size larger liquid pipe starting with the section of piping where 40m [131ft] is exceeded and all piping after that point.  
 In the figure above, if the piping labeled "E" exceeds 40m [131ft] (but does not exceed 90 m [295 ft.]), increase the size of the liquid piping labeled E, f, and g by one size.  
 \*4 30 m [98 ft.] is available. If the height difference between indoor units exceeds 15 m [49 ft.] (but does not exceed 30 m [98 ft.]), use one-size larger pipes for indoor unit liquid pipes.  
 In the figure above, if "h1" exceeds 15 m [49 ft.], increase the size of the liquid piping labeled g by one size.

Outdoor unit	Twinning kit	Pipe(Liquid)	Pipe(Gas)
PUHY-HP144TSNU/YSNU	CMY-Y100CBK3	ø12.7[1/2]	ø28.58[1-1/8]
PUHY-HP192-240TSNU/YSNU	CMY-Y100CBK3	ø15.88[5/8]	ø28.58[1-1/8]

For Piping size "S", "T", please refer to specification of the Twinning kit CMY-Y100CBK3 at the Outdoor unit's external drawing.

Total down-stream Indoor capacity	Joint
~ P72	CMY-Y102SS-G2
P73 ~ P144	CMY-Y102LS-G2
P145 ~ P240	CMY-Y202S-G2
P241 ~	CMY-Y302S-G2

\*Concerning detailed usage of joint parts, refer to its Installation Manual.  
 \*The total capacity of the units in the downstream of the branch joint on at least one of the piping lines that are connected to the branch joint should be 240 or below.  
 If the total capacity of the units in the downstream of the branch joints on both lines is above 240 use two branch joints (CMY-Y302S-G2).

Total down-stream Indoor capacity	Pipe(Liquid)	Pipe(Gas)
~ P54	ø9.52 [3/8]	ø15.88 [5/8]
P55 ~ P72	ø9.52 [3/8]	ø19.05 [3/4]
P73 ~ P108	ø9.52 [3/8]	ø22.20 [7/8]
P109 ~ P144	ø12.70 [1/2]	ø28.58 [1-1/8]
P145 ~ P240	ø15.88 [5/8]	ø28.58 [1-1/8]
P241 ~ P308	ø19.05 [3/4]	ø34.93 [1-3/8]
P309 ~	ø19.05 [3/4]	ø41.28 [1-5/8]

Table4-2. See the table below for the first joint of the outdoor unit described below.

Outdoor unit model	Joint model
HP144 to HP240	CMY-Y202S-G2

Indoor Unit size	Pipe(Liquid)	Pipe(Gas)
P04 ~ P18	ø6.35 [1/4]	ø12.70 [1/2]
P24 ~ P54	ø9.52 [3/8]	ø15.88 [5/8]
P72	ø9.52 [3/8]	ø19.05 [3/4]
P96	ø9.52 [3/8]	ø22.20 [7/8]

Total down-stream Indoor capacity	4-branch Header	8-branch Header	10-branch Header
<=P72	CMY-Y104C-G	CMY-Y108C-G	CMY-Y1010C-G
<=P144			
<=P240			

\* CMY-Y104C-G can directly connect PUHY-HP72T/YSNU, but can NOT directly connect PUHY-HP96T/YSNU or above;  
 \* CMY-Y108C-G can directly connect PUHY-HP72-144T/YSNU, but can NOT directly connect PUHY-HP192T/YSNU or above;  
 \* CMY-Y1010C-G can directly connect PUHY-HP72-240T/YSNU;  
 \* CMY-Y104C-G can NOT connect P72-P96 Indoor, but CMY-Y108, Y1010C-G can do;  
 \* Concerning detailed usage of Header parts, refer to its Installation Manual.

Note3. Indoor capacity is described as its model size;  
 For example, PEFY-P06NMAU-E3, its capacity is P06;  
 Note4. Total down-stream Indoor capacity is the summary of the model size of Indoors downstream.  
 For example, PEFY-P06NMAU-E3+PEFY-P08NMAU-E3: Total Indoor capacity=P06+P08=P14  
 Note5. Piping size determined by the Total down-stream indoor capacity is NOT necessary to be bigger than the up-stream one.  
 i.e. A>=B; A>C>=D

### 12-3. Refrigerant charging calculation

At the time of shipping, the outdoor unit is charged with the refrigerant. As this charge does not include the amount needed for extended piping, additional charging for each refrigerant line will be required on site. In order that future servicing may be properly provided, always keep a record of the size and length of each refrigerant line and the amount of additional charge by writing it in the space provided on the outdoor unit.

#### (1) Calculation of additional refrigerant charge

- Calculate the amount of additional charge based on the length of the piping extension and the size of the refrigerant line.
- Use the table to the below as a guide to calculating the amount of additional charging and charge the system accordingly.
- If the calculation results in a fraction of less than 0.1kg [4oz], round up to the next 0.1kg [4oz]. For example, if the result of the calculation was 12.38kg [436.4oz], round the result up to 12.4kg [437oz].
- \* When connecting PEFY-P06NMAU-E\*\*, PEFY-P18NMAU-E\*\*, PEFY-P24NMAU-E\*\*, PEFY-P30NMAU-E\*\*, or PEFY-P36NMAU-E\*\*, add 0.3 kg [11 oz] of refrigerant per indoor unit.
- \* When connecting PLFY-EP06NEMU\*\*-E\*\*, add 0.4 kg [15 oz] of refrigerant per indoor unit.
- \* When connecting PLFY-EP18NEMU\*\*-E\*\*, PLFY-EP24NEMU\*\*-E\*\*, PLFY-EP30NEMU\*\*-E\*\* or PLFY-EP36NEMU\*\*-E\*\*, add 0.65 kg [23oz] of refrigerant per indoor unit.

#### <Additional Charge>

Units "m" and "kg"

<Formula>

- When the piping length from the outdoor unit to the farthest indoor unit is 30.5 m (100 ft) or shorter

$$\text{Amount of additional charge (kg)} = \begin{cases} \varnothing 19.05 \text{ total length} \\ \times 0.29 \text{ (kg/m)} \end{cases} + \begin{cases} \varnothing 15.88 \text{ total length} \\ \times 0.2 \text{ (kg/m)} \end{cases} + \begin{cases} \varnothing 12.7 \text{ total length} \\ \times 0.12 \text{ (kg/m)} \end{cases} + \begin{cases} \varnothing 9.52 \text{ total length} \\ \times 0.06 \text{ (kg/m)} \end{cases} + \begin{cases} \varnothing 6.35 \text{ total length} \\ \times 0.024 \text{ (kg/m)} \end{cases}$$

Outdoor unit model	Amount (kg)	Total capacity of connected indoor units	Amount (kg)
HP72	0	27 or below	2.0
HP96	0	28 to 54	2.5
HP120	0	55 to 126	3.0
		127 to 144	3.5
		145 to 180	4.5
		181 to 234	5.0
		235 to 273	6.0
		274 to 307	8.0
		308 to 342	9.0
		343 to 411	10.0
		412 to 480	12.0
		481 or above	14.0

\*Amount of refrigerant to be charged for single-module units

- When the piping length from the outdoor unit to the farthest indoor unit is longer than 30.5 m (100 ft)

$$\text{Amount of additional charge (kg)} = \begin{cases} \varnothing 19.05 \text{ total length} \\ \times 0.26 \text{ (kg/m)} \end{cases} + \begin{cases} \varnothing 15.88 \text{ total length} \\ \times 0.18 \text{ (kg/m)} \end{cases} + \begin{cases} \varnothing 12.7 \text{ total length} \\ \times 0.11 \text{ (kg/m)} \end{cases} + \begin{cases} \varnothing 9.52 \text{ total length} \\ \times 0.054 \text{ (kg/m)} \end{cases} + \begin{cases} \varnothing 6.35 \text{ total length} \\ \times 0.021 \text{ (kg/m)} \end{cases}$$

Outdoor unit model	Amount (kg)	Total capacity of connected indoor units	Amount (kg)
HP72	0	27 or below	2.0
HP96	0	28 to 54	2.5
HP120	0	55 to 126	3.0
		127 to 144	3.5
		145 to 180	4.5
		181 to 234	5.0
		235 to 273	6.0
		274 to 307	8.0
		308 to 342	9.0
		343 to 411	10.0
		412 to 480	12.0
		481 or above	14.0

\*Amount of refrigerant to be charged for single-module units

Units "ft" and "oz"

<Formula>

- When the piping length from the outdoor unit to the farthest indoor unit is 30.5 m (100 ft) or shorter

$$\text{Amount of additional charge (oz)} = \left[ \begin{matrix} \varnothing 3/4 \text{ total length} \\ \times 3.1 \text{ (oz/ft)} \end{matrix} \right] + \left[ \begin{matrix} \varnothing 5/8 \text{ total length} \\ \times 2.15 \text{ (oz/ft)} \end{matrix} \right] + \left[ \begin{matrix} \varnothing 1/2 \text{ total length} \\ \times 1.29 \text{ (oz/ft)} \end{matrix} \right] + \left[ \begin{matrix} \varnothing 3/8 \text{ total length} \\ \times 0.65 \text{ (oz/ft)} \end{matrix} \right] + \left[ \begin{matrix} \varnothing 1/4 \text{ total length} \\ \times 0.26 \text{ (oz/ft)} \end{matrix} \right]$$

Outdoor unit model	Amount (oz)
HP72	0
HP96	0
HP120	0

\*Amount of refrigerant to be charged for single-module units

Total capacity of connected indoor units	Amount (oz)
27 or below	71
28 to 54	89
55 to 126	106
127 to 144	124
145 to 180	160
181 to 234	177
235 to 273	212
274 to 307	283
308 to 342	318
343 to 411	353
412 to 480	424
481 or above	494

- When the piping length from the outdoor unit to the farthest indoor unit is longer than 30.5 m (100 ft)

$$\text{Amount of additional charge (oz)} = \left[ \begin{matrix} \varnothing 3/4 \text{ total length} \\ \times 2.80 \text{ (oz/ft)} \end{matrix} \right] + \left[ \begin{matrix} \varnothing 5/8 \text{ total length} \\ \times 1.94 \text{ (oz/ft)} \end{matrix} \right] + \left[ \begin{matrix} \varnothing 1/2 \text{ total length} \\ \times 1.19 \text{ (oz/ft)} \end{matrix} \right] + \left[ \begin{matrix} \varnothing 3/8 \text{ total length} \\ \times 0.58 \text{ (oz/ft)} \end{matrix} \right] + \left[ \begin{matrix} \varnothing 1/4 \text{ total length} \\ \times 0.23 \text{ (oz/ft)} \end{matrix} \right]$$

Outdoor unit model	Amount (oz)
HP72	0
HP96	0
HP120	0

\*Amount of refrigerant to be charged for single-module units

Total capacity of connected indoor units	Amount (oz)
27 or below	71
28 to 54	89
55 to 126	106
127 to 144	124
145 to 180	160
181 to 234	177
235 to 273	212
274 to 307	283
308 to 342	318
343 to 411	353
412 to 480	424
481 or above	494

■ Amount of factory charged refrigerant

Outdoor unit model	Charged amount	
HP72	9.8kg	[346 oz]
HP96	10.8kg	[381 oz]
HP120	10.8kg	[381 oz]

PUHY-HP-T(S)NU-A, Y(S)NU-A

Example: PUHY-HP120TNU/YNU

m [kg]						ft. [oz]					
Indoor	1: P48	A: ø12.7	40 m	a: ø9.52	10 m	Indoor	1: P48	A: ø1/2"	131ft.	a: ø3/8"	32ft.
	2: P36	B: ø9.52	10 m	b: ø9.52	5 m		2: P36	B: ø3/8"	32ft.	b: ø3/8"	16ft.
	3: P15	C: ø9.52	8 m	c: ø6.35	10 m		3: P15	C: ø3/8"	26ft.	c: ø1/4"	32ft.
	4: P12	D: ø9.52	10 m	d: ø6.35	10 m		4: P12	D: ø3/8"	32ft.	d: ø1/4"	32ft.
	5: P24			e: ø9.52	10 m		5: P24			e: ø3/8"	32ft.

The total length of liquid pipe of each size is as follows:  
 ø12.7 : A= 40 = 40 m  
 ø9.52 : B + C + D+ a + b + e = 10 + 8 + 10 + 10 + 5 + 10 = 53 m  
 ø6.35 : c + d = 10 + 10 = 20 m

Total capacity of connecting Indoor units Pt :  
 Pt = P48 + P36 + P15 + P12 + P24 = P135

The total length of liquid pipe of each line is as follows:  
 ø1/2" : A= 131 = 131ft.  
 ø3/8" : B + C + D + a + b + e = 32 + 26 + 32 + 32 + 16 + 32 = 170ft.  
 ø1/4" : c + d = 32 + 32 = 64ft.

Total capacity of connecting Indoor units Pt :  
 Pt = P48 + P36 + P15 + P12 + P24 = P135

m [kg]						ft. [oz]					
Additional refrigerant charge	=	Total length of liquid pipe sized ø19.05 x 0.26 (kg/m)	+	Total length of liquid pipe sized ø15.88 x 0.18 (kg/m)	+	Total length of liquid pipe sized ø12.7 x 0.11 (kg/m)	+	Total length of liquid pipe sized ø9.52 x 0.054 (kg/m)	+	Total length of liquid pipe sized ø6.35 x 0.021 (kg/m)	+ 0 + 3.5
(kg)		0 (m) x 0.26 (kg/m)		0 (m) x 0.18 (kg/m)		40 (m) x 0.11 (kg/m)		53 (m) x 0.054 (kg/m)		20 (m) x 0.021 (kg/m)	
	=	0	+	0	+	40 x 0.11	+	53 x 0.054	+	20 x 0.021	+ 0 + 3.5
		= 11.2 kg									
or											
Additional refrigerant charge	=	Total length of liquid pipe sized ø3/4" x 2.80 (oz/ft.)	+	Total length of liquid pipe sized ø5/8" x 1.94 (oz/ft.)	+	Total length of liquid pipe sized ø1/2" x 1.19 (oz/ft.)	+	Total length of liquid pipe sized ø3/8" x 0.58 (oz/ft.)	+	Total length of liquid pipe sized ø1/4" x 0.23 (oz/ft.)	+ 0 + 124
(oz)		0 (ft.) x 2.80 (oz/ft.)		0 (ft.) x 1.94 (oz/ft.)		131 (ft.) x 1.19 (oz/ft.)		170 (ft.) x 0.58 (oz/ft.)		64 (ft.) x 0.23 (oz/ft.)	
	=	0	+	0	+	131 x 1.19	+	170 x 0.58	+	64 x 0.23	+ 0 + 124
		= 394 [oz]									

PUHY-HP-T(S)NU-A, Y(S)NU-A

■ Limitation of the amount of refrigerant to be charged

The above calculation result of the amount of refrigerant to be charged must become below the value in the table below.

Total index of the outdoor units		HP72 T/YNU	HP96 T/YNU	HP120 T/YNU	HP144 T/YSNU	HP192 T/YSNU	HP240 T/YSNU
Maximum refrigerant charge	Factory charged	9.8kg	10.8kg	10.8kg	19.6kg	21.6kg	21.6kg
	Charged on site	19.9kg	22.5kg	23.9kg	31.3kg	31.1kg	32.0kg
	Total for system	29.7kg	33.3kg	34.7kg	50.9kg	52.7kg	53.6kg
	Factory charged	21 lbs 10 oz	23 lbs 12 oz	23 lbs 12 oz	43 lbs 4 oz	47 lbs 10 oz	47 lbs 10 oz
	Charged on site	43 lbs 15 oz	49 lbs 10 oz	52 lbs 10 oz	68 lbs 16 oz	68 lbs 9 oz	70 lbs 9 oz
	Total for system	65 lbs 9 oz	73 lbs 7 oz	76 lbs 7 oz	112 lbs 4 oz	116 lbs 3 oz	118 lbs 3 oz

### 13-1. General requirements for installation

1. If possible, locate the unit to reduce the direct thermal radiation to the unit.
2. Consider the amount of noise the unit produces when choosing an installation location.  
**Valves and refrigerant flow on the outdoor/heat source unit may generate noise.**
3. Avoid sites that may encounter strong winds.
4. Ensure the installation site can bear the weight of the unit.
5. Condensation should be moved away from the unit, particularly in heating mode.
6. Provide enough space for installation and service as shown in section 13-2. Spacing.
7. Avoid sites where acidic solutions or chemical sprays (such as sulfur sprays) are used frequently.
8. The unit should be provided from combustible gas, oil, steam, chemical gas like acidic solution, sulfur gas and so on.



13-2. Spacing

In case of single installation

(1) When all walls are within their height limits\*.

[mm (in)]

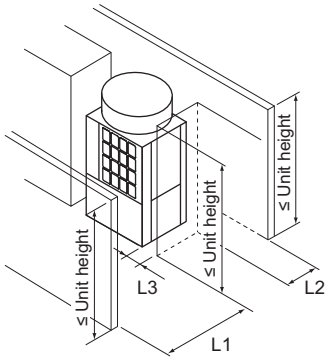

\* Height limit

Front/Right/Left/Rear	Same height or lower than the overall height of the unit
-----------------------	--

	Required minimum distance [mm (in)]		
	L1 (Front)	L2 (Rear)	L3 (Right/Left)
When the distance behind the unit (L2) needs to be small	450 (17-3/4)	300 (11-13/16)	450 (17-3/4)
When the distance to the right or left (L3) needs to be small	450 (17-3/4)	450 (17-3/4)	30 (1-3/16)

(2) When one or more walls exceed their height limits\*.

When the wall(s) at the front and/or the right/left exceed(s) their height limits

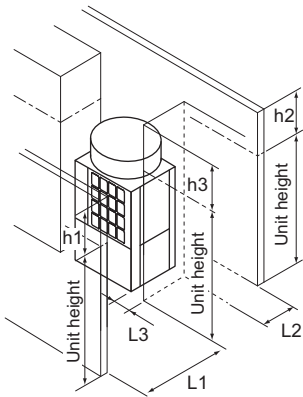

When the wall at the rear exceeds its height limit

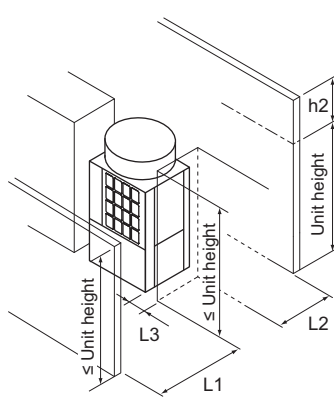

When all walls exceed their height limits

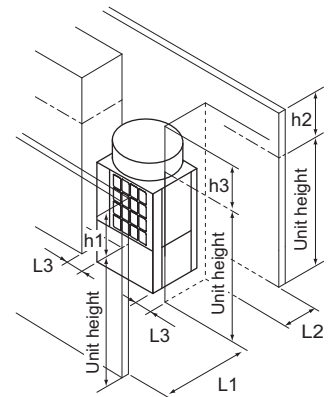

Add the dimension that exceeds the height limit (shown as "h1" through "h3" in the figures) to L1, L2, and L3 as shown in the table below.

	Required minimum distance [mm (in)]		
	L1 (Front)	L2 (Rear)	L3 (Right/Left)
When the distance behind the unit (L2) needs to be small	450 (17-3/4) + h1	300 (11-13/16) + h2	450 (17-3/4) + h3
When the distance to the right or left (L3) needs to be small	450 (17-3/4) + h1	450 (17-3/4) + h2	30 (1-3/16) + h3

(3) When there are overhead obstacles

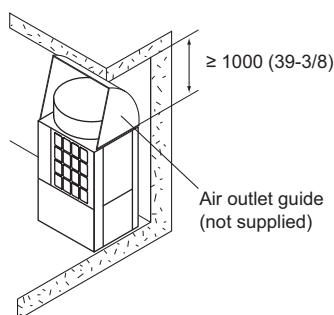
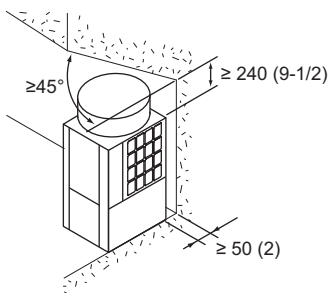

PUHY-HP-T(S)NU-A, Y(S)NU-A

**In case of collective installation and continuous installation**

- When installing multiple units, make sure to take into consideration factors such as providing enough space for people to pass through, ample space between blocks of units, and sufficient space for airflow. (The areas marked with [A] in the figures below must be left open.)
- In the same way as with the single unit installation, add the dimension that exceeds the height limit (shown as "h1" through "h3" in the figures) to L1, L2, and L3 as shown in the tables below.
- If there are walls in the front and rear of the block of units, up to six units can be installed consecutively side by side, and a space of 1000 mm (39-3/8 in) or more must be left between each block of six units.

**(1) Side-by-side installation**

When the distances between the units (L4) need to be small

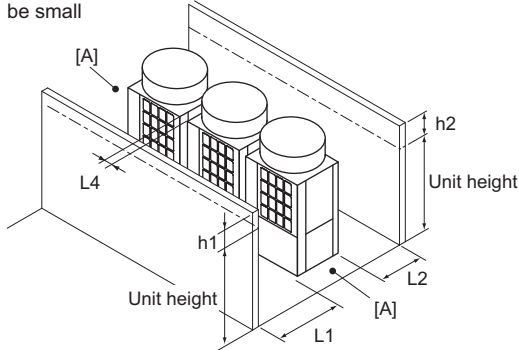

Required minimum distance [mm (in)]		
L1 (Front)	L2 (Rear)	L4 (Between)
450 (17-3/4) + h1	450 (17-3/4) + h2	30 (1-3/16)

When the distance behind the block of units (L2) needs [mm (in)] to be small

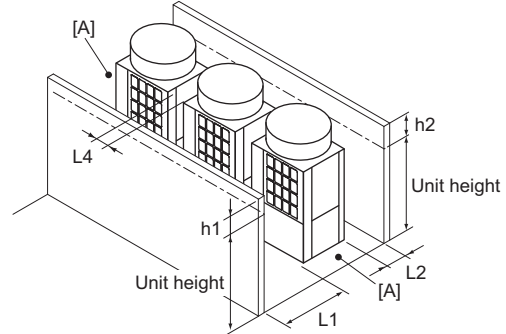

Required minimum distance [mm (in)]		
L1 (Front)	L2 (Rear)	L4 (Between)
450 (17-3/4) + h1	300 (11-13/16) + h2	450 (17-3/4)

**(2) Face-to-face installation**

When there are walls in the front and rear of the block of units

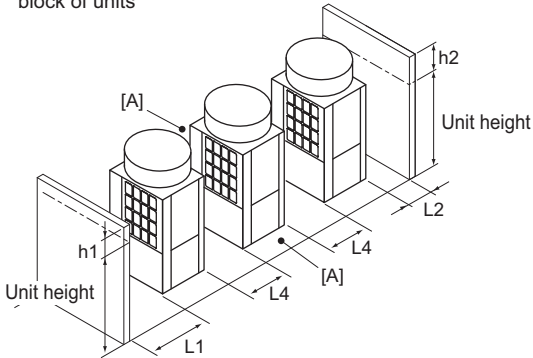

Required minimum distance [mm (in)]		
L1 (Front)	L2 (Rear)	L4 (Between)
450 (17-3/4) + h1	300 (11-13/16) + h2	450 (17-3/4)

When there is a wall on either the right or left side of the block of units

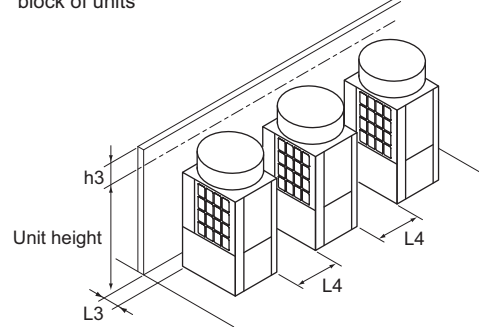

Required minimum distance [mm (in)]	
L3 (Right/Left)	L4 (Between)
30 (1-3/16) + h3	450 (17-3/4)

**(3) Combination of face-to-face and side-by-side installations**

When there are walls in the front and rear of the block of units

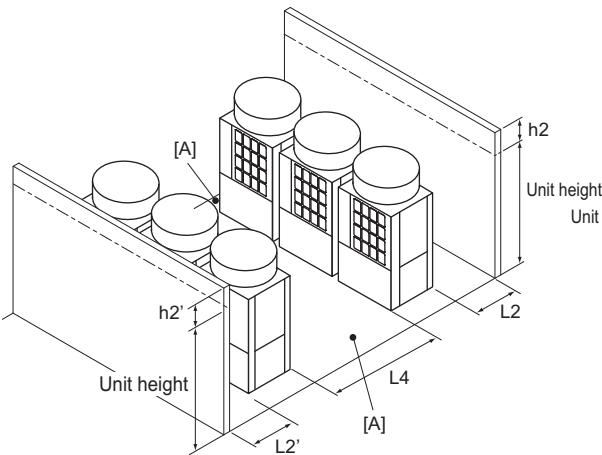

Required minimum distance [mm (in)]		
L2 (Rear)	L2' (Rear)	L4 (Between)
450 (17-3/4) + h2	450 (17-3/4) + h2'	900 (35-7/16)

When there are two walls in an L-shape

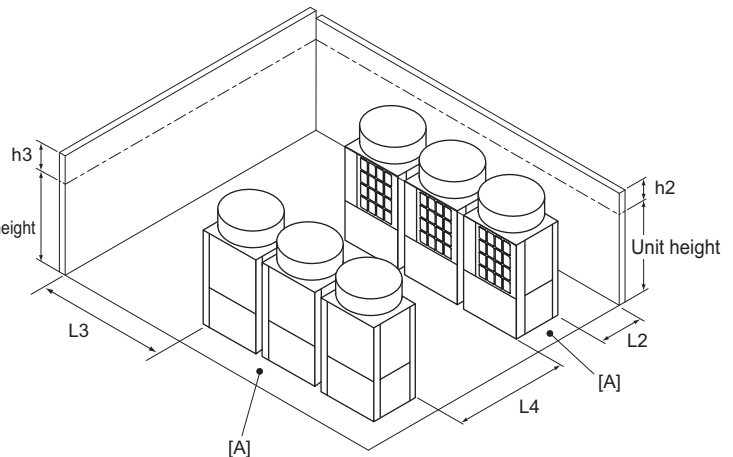

Required minimum distance [mm (in)]		
L2 (Rear)	L3 (Right/Left)	L4 (Between)
450 (17-3/4) + h2	1000 (39-3/8) + h3	900 (35-7/16)

[A]: Leave open in two directions.

### 13-3. Piping direction

#### 13-3-1. Lifting method

- Always use two slings to lift up the unit. Each sling must be at least 8 m (26 ft) long and must be able to support the weight of the unit.
- Put protective pads between slings and the unit where the slings touch the unit at the base to protect the unit from being scratched.
- Put 50 mm (2 in) or thicker protective pads between slings and the unit where the slings touch the unit at the top of the unit to protect the unit from being scratched and to avoid contact with the slings and the fan guard.
- Make sure that the angles between slings at the top are less than 40 degrees

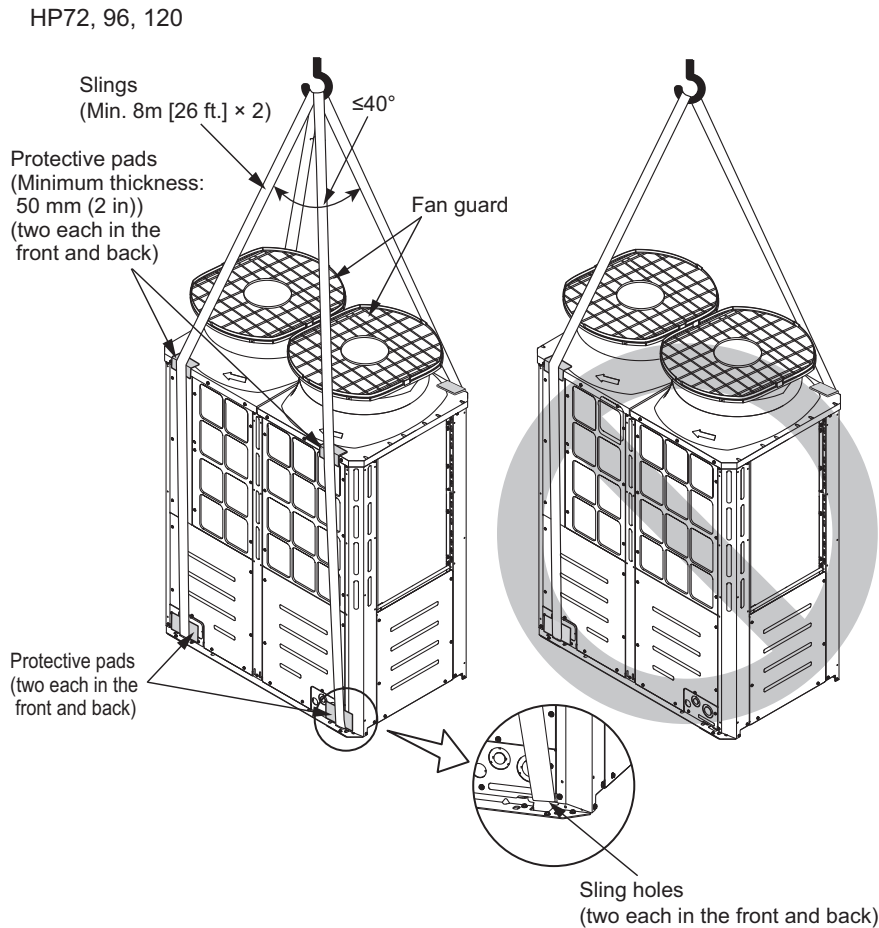

#### **CAUTION**

##### **Exercise caution when transporting products.**

- Products weighing more than 20 kg [45 LBS] should not be carried alone.
- Do not carry the product by the PPbands.
- To avoid the risk of injury, do not touch the heat exchanger fins.
- Plastic bags may pose a risk of choking hazard to children. Tear plastic bags into pieces before disposing of them.
- When lifting and transporting outdoor units with ropes, run the ropes through lifting hole at the unit base. Securely fix the unit so that the ropes will not slide off, and always lift the unit at four points to prevent the unit from falling.

PUHY-HP-T(S)NU-A, Y(S)NU-A

13-3-2. Installation

- Secure the unit with anchor bolts as shown in the figure below so that the unit will not topple over with strong wind or during an earthquake.
- Install the unit on a durable base made of such materials as concrete or angle steel.
- Take appropriate anti-vibration measures (e.g., vibration damper pad, vibration isolation base) to keep vibrations and noise from being transmitted from the unit through walls and floors.
- When installing a unit on a base, place an anti-vibration pad between the base and the unit.
- When using an anti-vibration rubber pad, install it so that the pad covers the entire width of the unit leg.
- All the bottom corners of the unit must still be supported by both the anti-vibration rubber pads and the base.
- Install the unit in such a way that the corner of the angle bracket at the base of the unit shown in the figure below is securely supported.
- Install the anchor bolt in such a way that the top end of the anchor bolt do not stick out more than 30 mm [1-3/16 in.].
- This unit is not designed to be anchored with post-installation-type anchor bolts, although by adding fixing brackets anchoring with such type of anchor bolts becomes possible.

(A) M10 anchor bolt\* procured at the site

\*Required specification for M10 anchor bolt: Tensile load of 5.6 kN or more to withstand the short-term load caused by earthquakes or strong winds

(B) (Incorrect installation) The corner section is not securely received.

(C) Fixing bracket for M12 hole-in anchor bolt\* procured at the site (3 locations to fix with M5 self-tapping screws)

\*Required specification for M12 hole-in anchor bolt: Tensile load of 6.7 kN or more to withstand the short-term load caused by earthquakes or strong winds  
Use the fixing bracket with sufficient strength.

(D) Anti-vibration rubber pad  
(The pad needs to be large enough to cover the entire width of each unit leg.)

**! WARNING**  
Properly install the unit on a surface that can withstand the weight of the unit. Unit installed on an unstable surface may fall and cause injury.

**! WARNING**  
Take adequate measures against natural disasters including earthquakes and windstorms so that the unit will not fall or tip over. Consult your local specialist for safety measures to be taken.

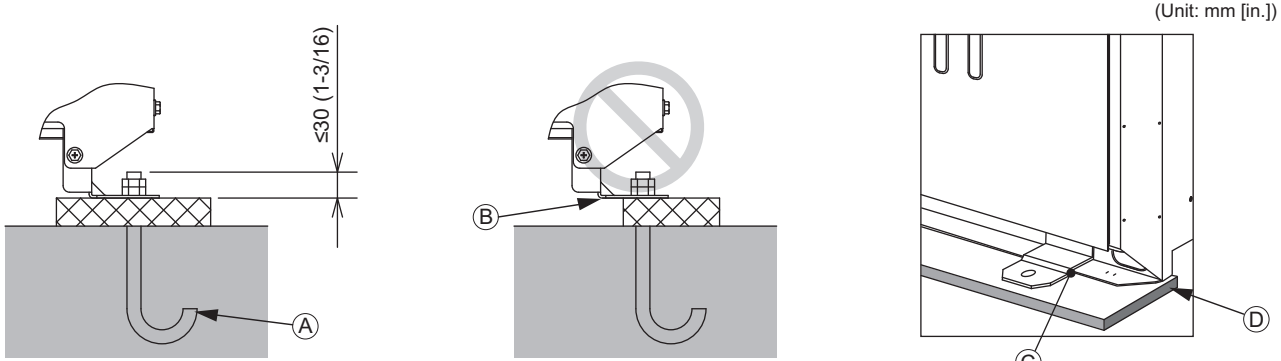

(Unit: mm [in.])

Take into consideration the durability of the base, water drainage route (Drain water is discharged from outdoor units during operation.), piping route, and wiring route when performing foundation work.

13-3-3. Anchor bolt positions

(Unit: mm [in.])

<HP72-120>

• Individual installation

• Collective installation

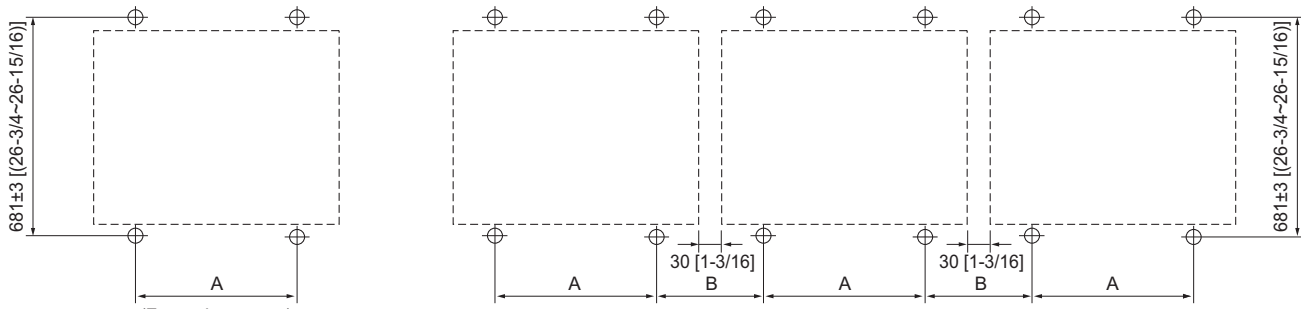

Leave a minimum of 30 mm [1-3/16 in.] between units.

PUHY	HP72, 96, 120
A	1060±2 [41-3/4(41-11/16~41-13/16)]
B	210 [8-5/16]

13-3-4. Installation

When the pipes and/or cables are routed at the bottom of the unit, make sure that the through hole at the base of the unit does not get blocked with the installation base.  
 When the pipes are routed at the bottom of the unit, the base should be at least 100 mm [3-15/16 in.] in height.

HP72, 96, 120

(Unit: mm[in.])

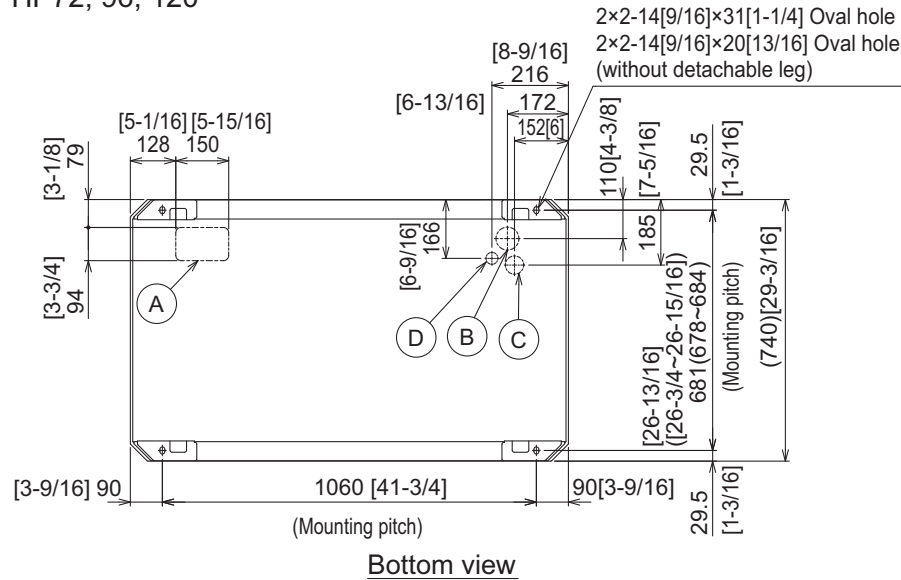

NO.	Usage		Specifications
(A)	For pipes	Bottom through hole	150 × 94 Knockout hole [5-15/16] [3-3/4]
(B)	For wires	Bottom through hole	ø65 Knockout hole [2-9/16]
(C)		Bottom through hole	ø52 Knockout hole [2-1/16]
(D)	For transmission cables	Bottom through hole	ø34 Knockout hole [1-3/8]

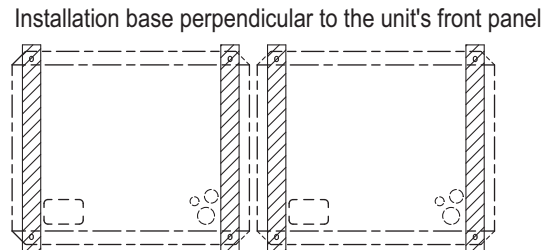
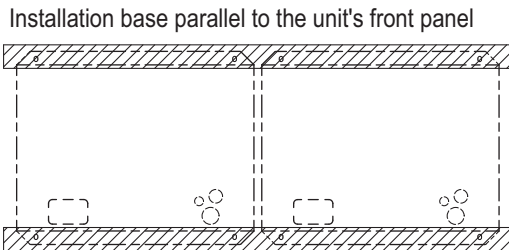

13-3-5. Refrigerant pipe routing

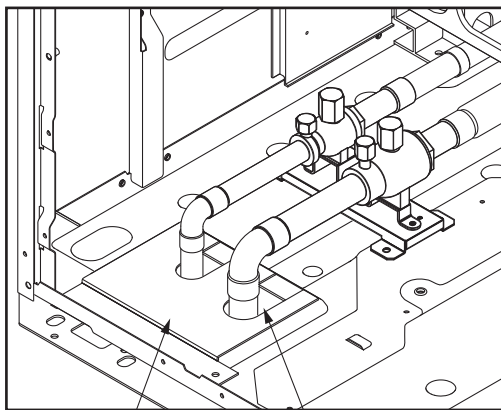

Example of closure materials (field supply)      Fill the gap at the site

The gaps around the edges of through holes for pipes and wires on the unit allow water or mice to enter the unit and damage its parts. Close these gaps with filler plates.

This unit allows two types of pipe routing:

- Bottom piping
- Front piping

**CAUTION**

To prevent small animals, water and snow from entering the unit and damage its parts, close the gap around the edges of through holes for pipes and wires with filler plates.

PUHY-HP-T(S)NU-A, Y(S)NU-A

13-3-6. Twinning on the outdoor unit side

- The pipe from multiple outdoor units must be installed so that oil will not accumulate in the pipe under certain conditions. Refer to the figures below for details.

\* Small dots in the figures indicate branching points.

Ⓐ To indoor units

- The pipe from the outdoor units must be inclined downward to the indoor unit side. In the figure on the right, because the pipe is inclined upward, the oil in the pipe accumulates when Unit 1 is in operation and Unit 2 is stopped.



- The distance between the unit bottom and the pipe (H) must be 0.2 m (7-7/8 in) or below. In the figure on the right, because the distance is more than 0.2 m (7-7/8 in), the oil accumulates in Unit 1 when Unit 2 is in operation and Unit 1 is stopped.



- The vertical separation between units (H) must be 0.1 m (3-15/16 in) or below. In the figure on the right, because the distance is more than 0.1 m (3-15/16 in), the oil accumulates in Unit 1 when Unit 2 is in operation and Unit 1 is stopped.



- The vertical separation between units (H) must be 0.1 m (3-15/16 in) or below. In the figure on the right, because the distance is more than 0.1 m (3-15/16 in), the oil accumulates in Unit 2 when Unit 1 is in operation and Unit 2 is stopped.



- Make sure that the inclination tolerance of the Twinning pipe is  $\pm 15^\circ$  to the ground to avoid unit damage.

Ⓐ Twinning pipe

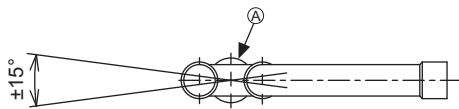

- If the length of the pipe between the branching point and the outdoor unit exceeds 2 m (6 ft), provide a trap within 2 m (6 ft) from the branching point.

The trap must be at least 200 mm (7-7/8 in) in height. (gas pipe only) If there is no trap, oil can accumulate inside the pipe, causing a shortage of oil and may damage the compressor.

\* Small dots in the figures indicate branching points.



Ⓐ To indoor units  
Ⓑ Trap (gas pipe only)  
Ⓒ Gas pipe

**Caution:**

- Do not install traps other than the ones between outdoor units described on a separate sheet to prevent oil backflow and compressor start-up failure.
- Do not install solenoid valves to prevent oil backflow and compressor start-up failure.
- Do not install a sight glass because it may show improper refrigerant flow.
- If a sight glass is installed, inexperienced technicians that use the glass may overcharge the refrigerant.
- Refrigerant pipes may expand or shrink due to temperature fluctuations of the refrigerant inside the pipes. When installing long straight pipes, provide traps to absorb the thermal expansions of the pipes.

<PUHY-HP144, 192, 240TSNU/YSNU>

<PUHY-HP144, 192, 240TSNU/YSNU>

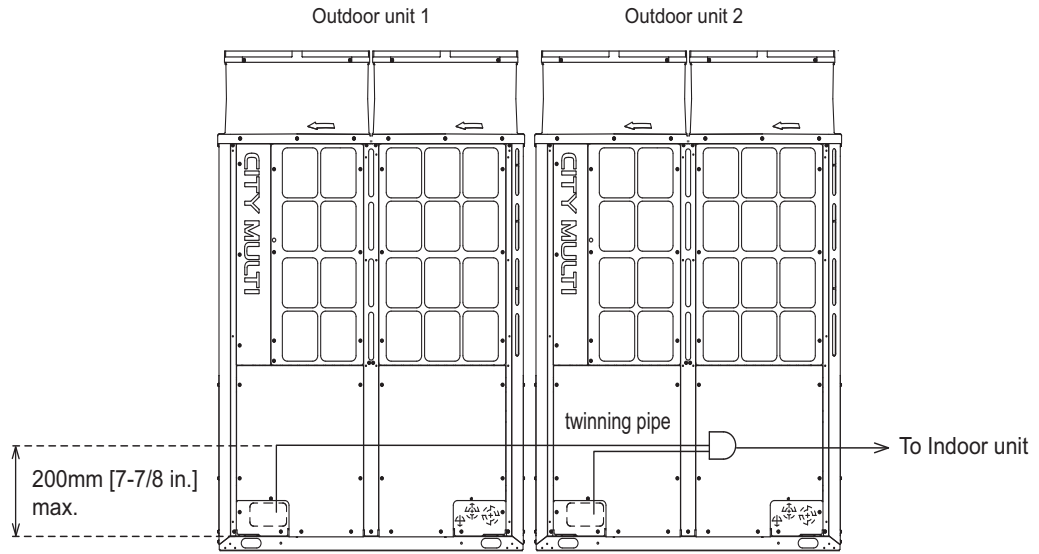

13-3-7. Twinning on the outdoor unit side

See the following drawing for connecting the pipes between the outdoor units.

<In case of 2units combination>

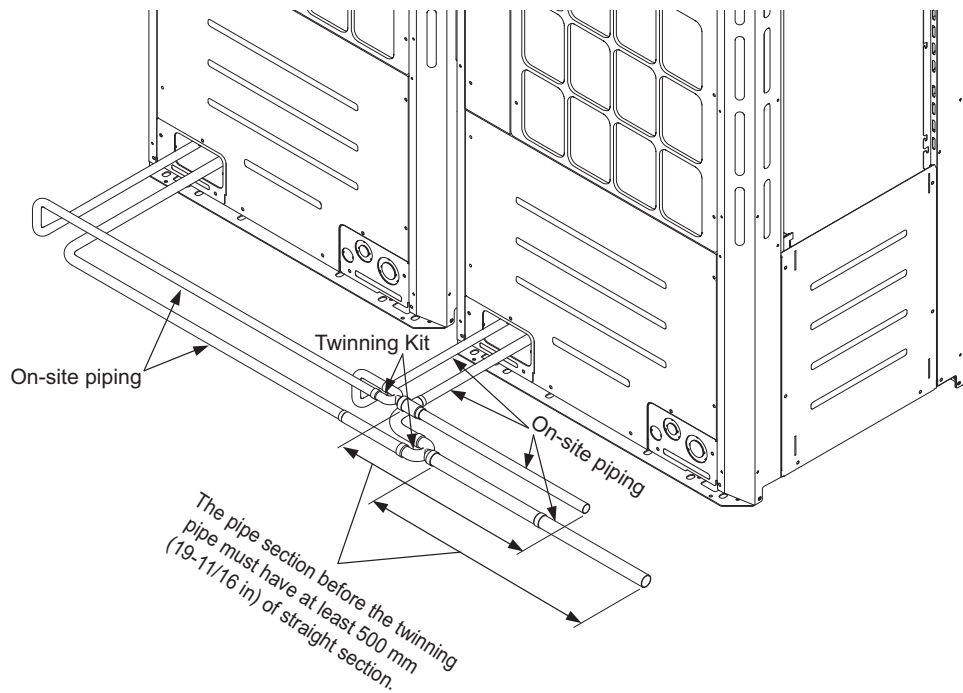

**CAUTION**

The length of the straight pipe must be 500mm [19-11/16 in.] or longer. If not, it may cause improper operation.



PUHY-HP-T(S)NU-A, Y(S)NU-A

### 13-4. Weather countermeasure

In cold and/or snowy areas, sufficient countermeasures to wind and snow damages should be taken for operating unit in normal and good condition in winter time. Surround the units with snow nets or fences to protect them from snow. Even in the other areas, full consideration is required for installation of unit in order to prevent abnormal operations caused by wind or snow. **When rain and snow directly fall on unit in the case of air-conditioning operations in 10 or less degrees centigrade outdoor air (50 or less degrees fahrenheit outdoor air), mount inlet and outlet ducts on unit for assuring stable operations. It is recommended to install a duct to fully make use of the advantages of the panel heater.**

Countermeasure to snow and wind

Prevention the Outdoor unit from wind and snow damages in cold or snowy areas, snow hood shown below is recommended and helpful.

\*Do not use a snow hood made of stainless steel, which may cause the unit to rust. If the use of a stainless snow hood is the only option, contact the sales office before installing it.

\*When installing a snow hood, take pressure loss into consideration to prevent airflow from decreasing.

- Snow hood

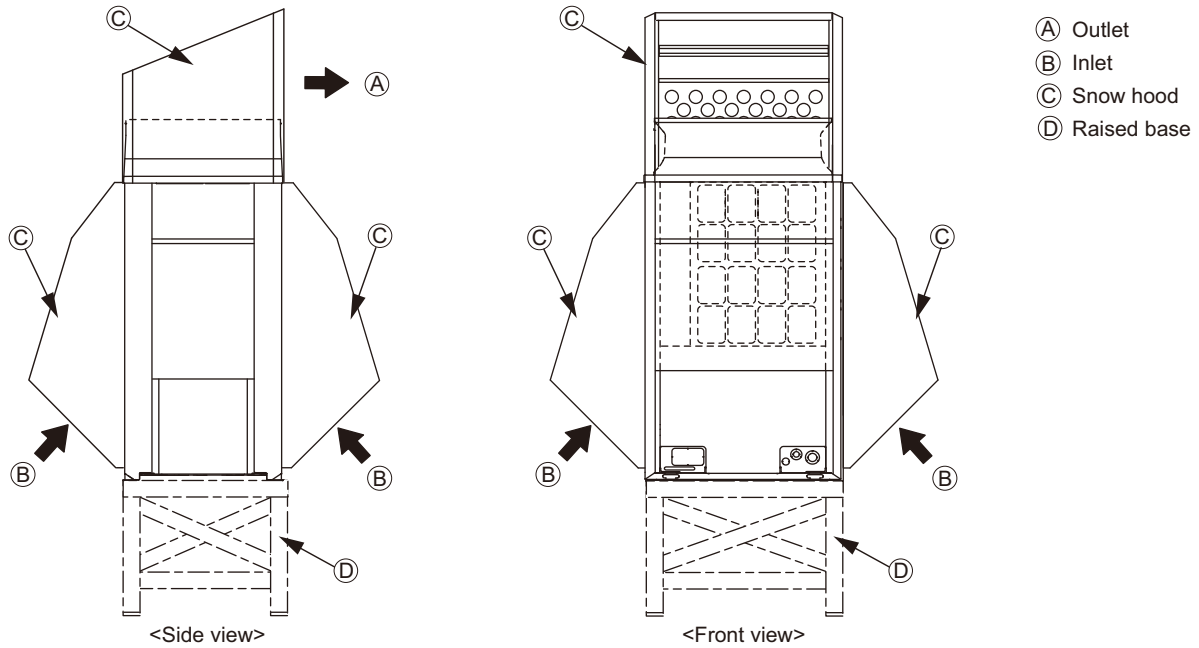

### 13-5. Countermeasure to wind

Referring to the figure shown below, take appropriate measures which will suit the actual situation of the place for installation. A unit installed alone is vulnerable to strong winds. Select the installation site carefully to minimize the effect of winds.

To install a unit in a place where the wind always blows from the same direction, install the unit so that the outlet faces away from the direction of the wind.

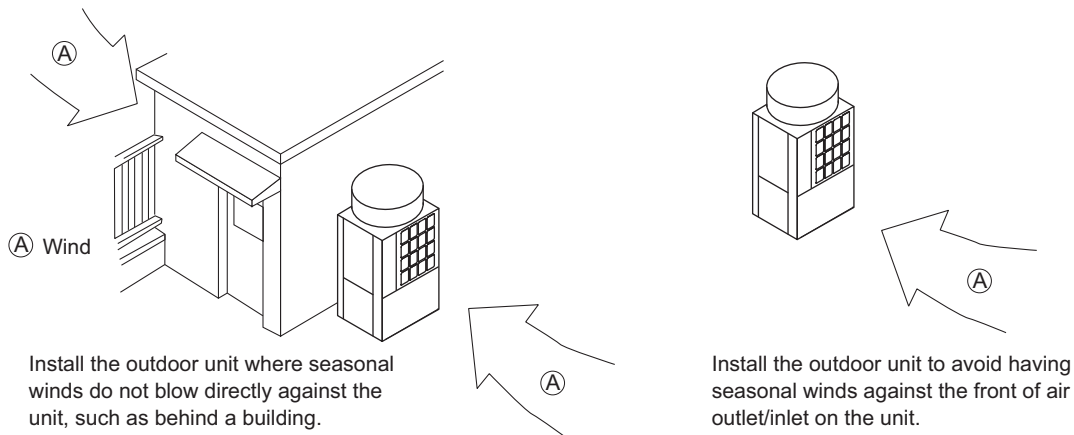

## Installation information

1. Installation information .....	2
1-1. General precautions .....	2
1-2. Precautions for Indoor unit and BC controller .....	4
1-3. Precautions for outdoor unit/heat source unit .....	5
1-4. Precautions for control-related items .....	6

\* Refer to the enclosed Installation Manual for details on installation. Arrange to have an expert install the system correctly.

## 1-1. General precautions

### 1-1-1. Usage

- ♦The air-conditioning system described in this DATA BOOK is designed for human comfort.
- ♦This product is not designed to assist in the preservation of food, provide conditions to maintain plants or animals, or stabilize environments for the preservation of precision equipment or art objects. To prevent loss of quality, do not use the product for purposes other than those it is designed for.
- ♦To reduce the risk of water leakage and electric shock, do not use the product for air-conditioning vehicles or vessels.

### 1-1-2. Installation environment

- ♦Do not install any unit other than the dedicated unit in an area where the voltage changes significantly, large amounts of mineral oil (e.g., cutting oil) are present, cooking oil may splash, or a large quantity of steam can be generated, such as a kitchen.
- ♦Do not install the unit in acidic or alkaline environments.
- ♦Installation should not be performed in locations exposed to chlorine or other corrosive gases. Avoid installation near sewers.
- ♦To reduce the risk of fire, do not install the unit in an area where flammable gas may leak or flammable material is present.
- ♦This air-conditioning unit has a built-in microcomputer. The effects of noise should be taken into consideration when deciding on the installation position. It is recommended that the air-conditioning unit be installed in a position away from antennas or electronic devices.
- ♦Install the unit on a solid foundation in accordance with local safety measures against typhoons, wind gusts, and earthquakes to prevent the unit from being damaged, toppling over, or falling.

### 1-1-3. Backup system

- ♦In regions in which the malfunctioning of the air conditioner may have a critical effect, it is recommended to have two or more systems made up of single outdoor/heat source units and multiple indoor units.

### 1-1-4. Unit characteristics

- ♦The heat pump efficiency of the outdoor unit depends on the outdoor temperature. In heating mode, performance drops as the outside air temperature drops. In cold climates, performance can be poor. Warm air will continue to be trapped near the ceiling and the floor level will remain cold. In such cases, heat pumps require a supplemental heating system or air circulator. Before purchasing, consult your local distributor for assistance in selecting the unit and system.
- ♦When the outdoor temperature is low and the humidity is high, the heat exchanger on the outdoor/heat source unit side tends to collect frost, which reduces its heating performance. The Auto-defrost function will be activated in order to remove the frost, and the heating mode will temporarily stop for 3-10 minutes. Heating mode will automatically resume upon completion of the defrost process.
- ♦An air conditioner with a heat pump requires time to warm up the whole room after the heating operation begins, because the system circulates warm air in order to warm up the whole room.
- ♦Sound levels were obtained in an anechoic room. Sound levels during actual operation are usually higher than the simulated values due to ambient noise and echoes. Refer to the section on "SOUND LEVELS" in the DATA BOOK for the measurement location.
- ♦Depending on the operating conditions, the unit generates noise caused by valve actuation, refrigerant flow, and pressure changes even when operating normally. Try to avoid positioning the air conditioner in locations where quietness is required. With regard to the BC/HBC controller, it is recommended that the unit be installed in areas such as corridor ceilings, restrooms and plant rooms.
- ♦The total capacity of the connected indoor units can be greater than the capacity of the outdoor/heat source unit. However, when the connected indoor units operate simultaneously, each unit's capacity may become smaller than the rated capacity.
- ♦When the unit is started up for the first time within 12 hours after the power comes on, i.e. after a power failure, it performs initial startup operation (capacity control operation) to prevent damage to the compressor. The initial startup operation requires a maximum of 90 minutes to complete, depending on the operating load.

### 1-1-5. Related equipment

- ♦Use an earth leakage breaker (ELB) with medium sensitivity, and an activation speed of 0.1 second or less.
- ♦Consult your local distributor or a qualified technician when installing an earth leakage breaker.
- ♦If the unit is an inverter type, select an earth leakage breaker able to respond to high harmonic waves and surges.
- ♦Leakage current is generated not only through the air-conditioning unit but also through the power wires. The leakage current of the main power supply is therefore greater than the total leakage current of each unit. Take the capacity of the earth leakage breaker or leakage alarm into consideration when installing one at the main power supply. To measure the leakage current simply on site, use a measurement tool equipped with a filter, and clamp all the four power wires together. The leakage current measured on the ground wire may not be accurate because the leakage current from other systems may be included in the measurement value.
- ♦Do not install a phase-advancing capacitor on a unit connected to the same power system as an inverter-type unit and its related equipment.
- ♦If a large current flows due to the malfunctioning of the product or faulty wiring, both the earth leakage breaker on the product side and the upstream overcurrent breaker may trip almost at the same time. Separate the power system or coordinate all the breakers depending on the system's priority level.

### 1-1-6. Unit installation

- ♦Your local distributor or a qualified technician must read the Installation Manual that is provided with each unit carefully before performing installation work.
- ♦Consult your local distributor or a qualified technician when installing the unit. Improper installation by an unqualified person may result in water leakage, electric shock, or fire.
- ♦Ensure that there is enough space around each unit.

### 1-1-7. Optional accessories

- ♦Only use accessories recommended by Mitsubishi Electric. Consult your local distributor or a qualified technician when installing them. Improper installation by an unqualified person may result in water leakage, power leakage, system breakdown, or fire.
- ♦Some optional accessories may not be compatible for use with the air-conditioning unit or may not be suitable for the installation conditions. Check the compatibility when considering any accessories.
- ♦Note that some optional accessories may affect the air conditioner's external form, appearance, weight, operating sound, and other characteristics.

### 1-1-8. Operation/Maintenance

- ♦Read the Instruction Book that is provided with each unit carefully prior to use.
- ♦Maintenance or cleaning of each unit may be risky and require expertise. Read the Instruction Book to ensure safety. Consult your local distributor or a qualified technician when special expertise is required, such as when the indoor unit needs to be cleaned.

## 1-2. Precautions for Indoor unit and BC controller

### 1-2-1. Operating environment

- The refrigerant (R410A) used in the air conditioner is non-toxic and nonflammable. However, if the refrigerant leaks, the oxygen level may drop to harmful levels. If the air conditioner is installed in a small room, measures must be taken to prevent the refrigerant concentration from exceeding the safety limit even if the refrigerant leaks.
- If the units operate in cooling mode at a humidity above 80%, condensation may collect and drip from the indoor units.
- Regular checking and cleaning of the drain drainage paths, such as the drain pan or the drain pump, is recommended to prevent clogging. The neglect of a clogged drain pump may trigger the water-leakage protection function which stops operation of the entire system.

### 1-2-2. Unit characteristics

- The return air temperature display on the remote controller may differ from the displays on the other thermometers.
- The clock on the remote controller may be displayed with a time lag of approximately one minute every month.
- The temperature measured by the built-in temperature sensor on the remote controller may differ from the actual room temperature due to the effect of the wall temperature.
- Use the built-in thermostat on the remote controller or a separately-sold thermostat when indoor units installed on or in the ceiling operate the automatic cooling/heating switchover.
- The room temperature may rise drastically due to Thermo OFF in areas where the air-conditioning load is large, such as computer rooms.
- Be sure to use a regular filter. If an irregular filter is installed, the unit may not operate properly, and operating noise may increase.
- The room temperature may increase above the preset temperature in environments in which the heating or air-conditioning load is small.

### 1-2-3. Unit installation

- The insulation for the low-pressure pipe between the BC controller and the outdoor/heat source unit must be at least 20 mm (13/16 in.) thick. If the unit is installed on the top floor or in a high-temperature, high-humidity environment, thicker insulation may be necessary.
- Do not have any branching points on the downstream of the refrigerant pipe header.
- When a field-supplied external thermistor is installed or when a device for demand control is used, the unit may stop abnormally or damage may occur to the electromagnetic contactor. Consult your local distributor for details.
- When indoor units employ fresh air intake, install a filter in the duct (locally procured) to remove dust from the air.
- The 4-way Cassette Type units that have an outside air inlet can be connected to the duct, but need a booster fan to be installed at site. Refer to the chapter "Indoor Unit" for the available range for fresh air intake volume.
- Employing fresh air intake for the indoor unit may increase the sound pressure level.
- Do not install the unit above the cooking or food processing area.

### 1-2-4. Noise level (Sound pressure level)

- The sound pressure level is a value measured in an anechoic room in accordance with the conventional method in JIS standard. The sound pressure level actually measured at the installation site is usually higher than the value indicated in this DATA BOOK due to the influence of ambient noise and echoes.

### 1-3. Precautions for outdoor unit/heat source unit

#### 1-3-1. Installation environment

- ♦The outdoor unit with the salt-resistant specification is recommended for use in an area in which it will be exposed to salt air.
  - ♦Even when the unit with the salt-resistant specification is used, it is not completely protected against corrosion. Be sure to follow the directions or precautions described in the Instruction Book and Installation Manual for installation and maintenance. The salt-resistant specification is referred to in the guidelines published by JRAIA (JRA9002).
  - ♦Install the unit in an area where the flow of discharge air is not obstructed. If the flow of discharge air is obstructed, short-cycling of discharge air may occur.
  - ♦Provide proper drainage around the base of the units; condensation may collect and drip from outdoor units. Provide water-proofing protection to the floor when installing the unit on the rooftop.
  - ♦In regions where snowfall can be expected, install the unit so that the outlet faces away from the direction of the wind, and install a snow guard to protect the unit from snow. Install the unit on a base approximately 50 cm (19-11/16 in.) higher than the expected snowfall. Close the openings for pipes and wiring, because the ingress of water and small animals may cause equipment damage. If a SUS snow guard is used, refer to the Installation Manual that comes with the snow guard and be careful with the installation to avoid the risk of corrosion.
  - ♦When the unit is expected to operate continuously for a long period of time at outside air temperatures of below 0°C (32°F), take appropriate measures, such as the use of a unit base heater, to prevent ice forming on the unit base. (Not applicable to the PUMY-Series)
  - ♦Install the snow guard so that the outlet/inlet faces away from the direction of the wind.
  - ♦When approximately 50 cm (19-11/16 in.) or more of snow accumulates on the snow guard, remove the snow from the guard. Install a roof that is strong enough to withstand loads caused by snow in areas where snow accumulates.
  - ♦Provide proper protection around the outdoor units in places such as schools to avoid the risk of injury.
  - ♦A cooling tower and heat source water circuit should be a closed circuit so that water is not exposed to the atmosphere. When a tank is installed to ensure that the circuit has enough water, minimize the contact with outside air to ensure that the oxygen dissolved in the water is 1 mg/L or less.
  - ♦Install a strainer (50 mesh or more recommended) on the water pipe inlet on the heat source unit.
  - ♦Interlock the heat source unit and water circuit pump.
  - ♦Note the following to prevent the freezing and bursting of pipes when the heat source unit is installed in an area where the ambient temperature can be 0°C (32°F) or below.
    - ♦Keep the water circulating to prevent it from freezing when the ambient temperature is 0°C (32°F) or below.
    - ♦Before a long period of non-use, be sure to purge the water from the unit.
  - ♦The salt-resistant unit is resistant to salt corrosion, but not salt-proof.
- Please note the following when installing and maintaining outdoor units in a marine environment.
1. Install the salt-resistant unit in an area in which it is not directly exposed to sea breezes, and minimize exposure to salt water mist.
  2. Avoid installing a sun shade over the outdoor unit, so that rain will wash away salt deposits off the unit.
  3. Install the unit horizontally to ensure proper water drainage from the base of the unit. Accumulation of water in the base of the outdoor unit will significantly accelerate corrosion.
  4. Periodically wash salt deposits off the unit, especially when the unit is installed in a coastal area.
  5. Repair all noticeable scratches after installation and during maintenance.
  6. Periodically check the unit, and apply an anti-rust agent and replace corroded parts as necessary.

#### 1-3-2. Circulating water

- ♦Regularly check the quality of the water in the heat source unit, following the guidelines published by JRAIA (JRA-GL02-1994).
- ♦A cooling tower and heat source water circuit should be a closed circuit so that water is not exposed to the atmosphere. When a tank is installed to ensure that the circuit has enough water, minimize the contact with outside air to ensure that the oxygen dissolved in the water is 1 mg/L or less.

#### 1-3-3. Unit characteristics

- ♦When the Thermo ON and OFF is frequently repeated on the indoor unit, the operating status of outdoor/heat source units may become unstable.

#### 1-3-4. Related equipment

- ♦Provide grounding in accordance with the local regulations.

#### 1-3-5. Noise level (Sound pressure level)

- ♦The sound pressure level is a value measured in an anechoic room in accordance with the conventional method in JIS standard. The sound pressure level actually measured at the installation site is usually higher than the value indicated in this DATA BOOK due to the influence of ambient noise and echoes.
- ♦Valve operation noise and refrigerant flow noise may occur from inside the outdoor unit/heat-source unit.

## 1-4. Precautions for control-related items

### 1-4-1. Product specification

- ♦To introduce the MELANS system, a consultation with us is required in advance. Especially to introduce the electricity charge-apportioning function or energy save function, further detailed consultation is required. Consult your local distributor for details.
- ♦Billing calculation for AE-200A/AE-50A/EW-50A, or the billing calculation unit is unique and based on our original method. (Backup operation is included.) It is not based on the metering method, and do not use it for official business purposes. It is not the method that the amount of electric power consumption (input) by air conditioner is calculated. Note that the electric power consumption by air conditioner is apportioned by using the ratio corresponding to the operation status (output) for each air conditioner (indoor unit) in this method.
- ♦In the apportioned billing function for AE-200A/AE-50A and EW-50A, separate watt-hour meters should be used for A-control units, K-control units, and CITY MULTI packaged air conditioners. It is recommended that an individual watt-hour meter should be used for large-capacity indoor units (with two or more addresses).
- ♦When using the peak cut function on the AE-200A/AE-50A or EW-50A, note that the control is performed once every minute and it takes time to obtain the effect of the control. Take appropriate measures such as lowering the criterion value. Power consumption may exceed the limits if the AE-200A/AE-50A or EW-50A malfunctions or stops. Provide a back-up remedy as necessary.
- ♦The controllers cannot operate while the indoor unit is OFF. (No error)  
Turn ON the power to the indoor unit when operating the controllers.
- ♦When using the interlocked control function on the AE-200A/AE-50A/EW-50A/PAC-YG66DCA or PAC-YG63MCA, do not use the control for fire prevention or security. (This function should never be used in a way that would put people's lives at risk.) Employ any methods or circuits that allow ON/OFF operation using an external switch in case of failure.

### 1-4-2. Installation environment

- ♦Surge protection may be required for the transmission line in areas where lightning strikes occur frequently.
- ♦The receiver for a wireless remote controller may not work properly due to the effect of general lighting. Leave a space of at least 1 m between the general lighting and the receiver.
- ♦When the auto-elevating panel is used and the system is operated using a wired remote controller, install the wired remote controller in a place where all the air conditioners being controlled (at least the bottom part of them) can be seen from the wired remote controller. If not, the descending panel may cause damage or injury; be sure to use a wireless remote controller designed for use with the elevating panel (sold separately).
- ♦Install the wired remote controller (switch box) in a place where the following conditions are met.
  - ♦Where the installation surface is flat
  - ♦Where the remote controller can detect an accurate room temperature  
The temperature sensors that detect the room temperature are installed both in the remote controller and in the indoor unit.  
When the room temperature is detected using the sensor in the remote controller, the main remote controller is used to detect the room temperature. In this case, follow the instructions below.
    - ♦ Install the controller in a place where it is not affected by a heat source.  
(If the remote controller faces direct sunlight or the direction of the supply air flow, the remote controller cannot detect the accurate room temperature.)
    - ♦ Install the controller in a place where the average room temperature can be detected.
    - ♦ Install the controller in a place where no other wires are present around the temperature sensor.  
(If other wires are present, the remote controller cannot detect an accurate room temperature.)
- ♦To prevent unauthorized access, always use a security device such as a VPN router when connecting the AE-200A/AE-50A or EW-50A to the Internet.



# CAUTION FOR REFRIGERANT LEAKAGE

---

1. Caution for refrigerant leakage .....	Ub-1-2
1-1. Refrigerant property .....	Ub-1-2
1-2. Confirm the Critical concentration and take countermeasure .....	Ub-1-2

# 1. Caution for refrigerant leakage

The installer and/or air conditioning system specialist shall secure safety against refrigerant leakage according to local regulations or standards. The following standard may be applicable if no local regulation or standard is available.

## 1-1. Refrigerant property

R410A refrigerant is harmless and incombustible. The R410A is heavier than the indoor air in density. Leakage of the refrigerant in a room has possibility to lead to a hypoxia situation. Therefore, the critical concentration specified below shall not be exceeded even if the leakage happens.

### • Critical concentration

Critical concentration hereby is the refrigerant concentration in which no human body would be hurt if immediate measures can be taken when refrigerant leakage happens.

**Critical concentration of R410A: 0.44kg/m<sup>3</sup>**  
**(The weight of refrigeration gas per 1 m<sup>3</sup> air conditioning space.);**

\* The Critical concentration is subject to ISO5149, EN378-1.

For the CITY MULTI system, the concentration of refrigerant leaked should not have a chance to exceed the critical concentration in any situation.

## 1-2. Confirm the Critical concentration and take countermeasure

The maximum refrigerant leakage concentration (Rmax) is defined as the result of the possible maximum refrigerant weight (Wmax) leaked into a room divided by its room capacity (V). It is referable to Fig.1-1. The refrigerant of Outdoor/Heat source unit here includes its original charge and additional charge at the site.

The additional charge is calculated according to the refrigerant charging calculation of each kind of Outdoor/Heat source unit, and shall not be over charged at the site. Procedure 1-2-1~3 tells how to confirm maximum refrigerant leakage concentration (Rmax) and how to take countermeasures against a possible leakage.

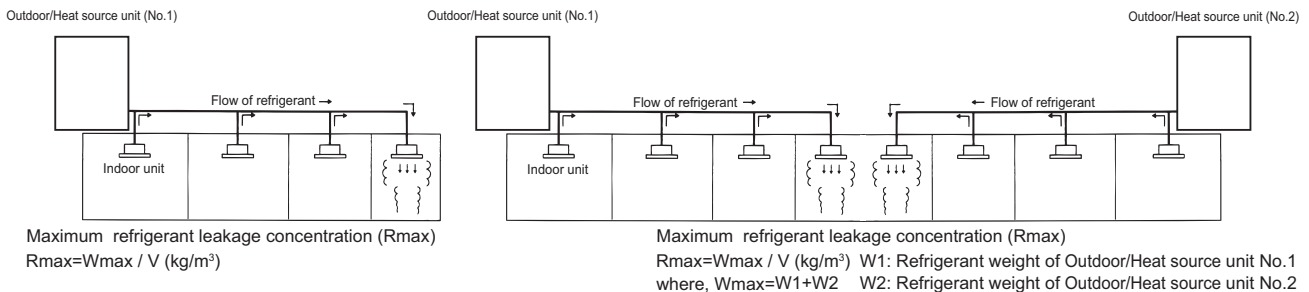

Fig. 1-1 The maximum refrigerant leakage concentration

### 1-2-1. Find the room capacity (V),

If a room having total opening area more than 0.15% of the floor area at a low position with another room/space, the two rooms/space are considered as one. The total space shall be added up.

### 1-2-2. Find the possible maximum leakage (Wmax) in the room. If a room has Indoor unit(s) from more than 1 Outdoor/Heat source unit, add up the refrigerant of the Outdoor/Heat source units.

### 1-2-3. Divide (Wmax) by (V) to get the maximum refrigerant leakage concentration (Rmax).

### 1-2-4. Find if there is any room in which the maximum refrigerant leakage concentration (Rmax) is over 0.44kg/m<sup>3</sup>.

If no, then the CITY MULTI is safe against refrigerant leakage.

If yes, following countermeasure is recommended to do at site.

#### Countermeasure 1: Let-out (making V bigger)

Design an opening of more than 0.15% of the floor area at a low position of the wall to let out the refrigerant whenever leaked. e.g. make the upper and lower seams of door big enough.

#### Countermeasure 2: Smaller total charge (making Wmax smaller)

e.g. Avoid connecting more than 1 Outdoor/Heat source unit to one room.  
 e.g. Using smaller model size but more Outdoor/Heat source units.  
 e.g. Shorten the refrigerant piping as much as possible.

#### Countermeasure 3: Fresh air in from the ceiling (Ventilation)

As the density of the refrigerant is bigger than that of the air. Fresh air supply from the ceiling is better than air exhausting from the ceiling. Fresh air supply solution refers to Fig. 1-2~4.

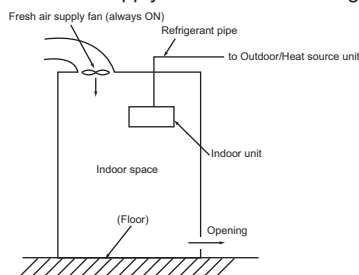

Fig. 1-2. Fresh air supply always ON

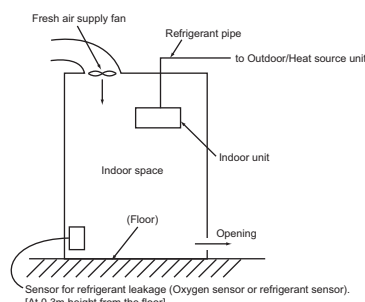

Fig. 1-3. Fresh air supply upon sensor action

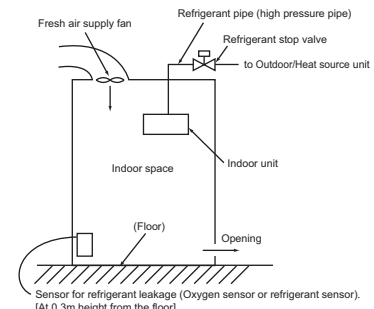

Fig. 1-4. Fresh air supply and refrigerant shut-off upon sensor action

Note 1. Countermeasure 3 should be done in a proper way in which the fresh air supply shall be on whenever the leakage happens.

Note 2. In principle, MITSUBISHI ELECTRIC requires proper piping design, installation and air-tight testing after installation to avoid leakage happening.

In the area should earthquake happen, anti-vibration measures should be fully considered.

The piping should consider the extension due to the temperature variation.

**⚠ Warning**

- Do not use refrigerant other than the type indicated in the manuals provided with the unit and on the nameplate.
  - Doing so may cause the unit or pipes to burst, or result in explosion or fire during use, repair, or at the time of disposal of the unit.
  - It may also be in violation of applicable laws.
  - MITSUBISHI ELECTRIC CORPORATION cannot be held responsible for malfunctions or accidents resulting from the use of the wrong type of refrigerant.
- Our air conditioning equipment and heat pumps contain a fluorinated greenhouse gas, R410A.

**MITSUBISHI ELECTRIC CORPORATION**

[www.MitsubishiElectric.com](http://www.MitsubishiElectric.com)