

Hand Dryer

Model

Single-phase 120VAC

JT-SB116EH-W-CA

Instruction Manual

For User

You should not attempt to install the unit yourself, as this may affect the safety and functionality of the unit.

- Read this manual thoroughly before beginning using the unit to ensure it is used safely and correctly. After reading the manual, store it in a location easily accessible for later reference.

Safety precautions



WARNING The following may lead to death or serious personal injury if done incorrectly.



Prohibited

- Do not install the unit yourself. This may affect the safety and functionality of the unit.
- Do not use at locations where salt damage may occur or where corrosive, neutral or reductive gases are present. Failure to do any of the above may cause fire, electric shock or trouble.



Do not use in shower room

- Do not use in shower room or other locations with a great deal of humidity in the air or where condensation may form on the unit. This may cause electric shock or malfunction.



Do not allow the unit to get wet

- Do not allow water to get on unit. This may cause electric shock.



Do not disassemble

- Do not modify or disassemble. This may cause fire, electric shock, or injury.
- When changing the installation place, consult your dealer or installer. There is risk of injury.

Important!
Follow instructions

- Turn off the switch before cleaning the unit. Not doing so may cause electric shock.
- This appliance is not intended for use by young children or infirm persons unless they are adequately supervised by a responsible person to ensure that they can use the appliance safely.
- Young children should be supervised to ensure that they do not play with the appliance.



CAUTION The following may lead to injury or damage to buildings or their contents if done incorrectly



Hot

- Care must be taken not to touch the heater exterior with hand or foot. Heater exterior becomes extremely hot during operation. Touching it may cause burn on hand or foot.



Prohibited

- Do not let children hang from the unit. This may cause the unit to fall.
- Do not use for purposes other than drying hands. Using the unit improperly can cause accidents.

Important!
Follow instructions

- Always use the unit with the drain tank and air filter attached. Any water entering the unit may cause short circuits and electric shock.
- Wear gloves when cleaning the unit. Not doing so may cause injury.
- If the unit stops working or begins acting strangely, turn off the power switch and ground-fault circuit interrupter and contact your dealer for inspection and repairs. Failure to do any of the above may cause electric shock or fire through short circuit.
- Wait till the heater exterior cools down before starting maintenance. Otherwise, it could cause burn.
- Make sure to install the air filter on the heater and close the panel before starting to use. Unless the filter is installed or panel is closed, dust entering the unit may cause fire.

Safety precautions (Continued)

Note

■ Do not use in the following locations:

- Locations where the temperature could be lower than 0°C or higher than 40°C.
- Locations where the humidity could be lower than 5% RH or higher than 95%RH.
- Locations where the unit may come into direct contact with water.
- Locations where the unit is under direct or strong sunlight. (May cause sensor to malfunction.)
- Locations where there is a lot of condensation.
- Do not use with chemicals (detergents, etc.) on your hands. (This may reduce the productive life of the unit.)
- Do not use in locations where corrosive, neutral, or reductive gases are present. (This may reduce the productive life of the unit and/or cause malfunctions.)
- Locations where salt damage may occur.
- Vehicles (incl. vessels, trains.)

Features

- "No-touch" hand drying, ensuring complete hygiene.
- The jet-blow air dries wet hands quickly. You only pay for the electricity used to run it, so it's economical.
- A tamper-proof timer is built in to prevent overuse.
- No need to throw out or replace paper towels, so maintenance is a cinch.
- Anti-microbial finish.

Tamper-proof timer

To prevent tampering with the unit, the built-in timer shuts it down after 30 seconds of continuous use. To continue use, remove hands and then re-insert.

Features of the heater

Hot jet-blow air ...

- As the jet-blow air is warmed with the heater, it will not feel cold even when using in winter. (The unit accumulates heat because the heater operates while the hand dryer is not used.)
- Hot blow air dries hands quickly.

Note

- Although the heater is turned on when the heater switch is turned "ON", the power is turned off automatically when the room temperature becomes higher than 35°C (temperatures at around the hand dryer).
- When the heater switch is turned "ON", the electricity is consumed because the heater operates while the hand dryer is not used.
- The heater is turned off automatically when using the hand dryer. (Motor and heater will not turn on simultaneously.)

Names and Uses of Parts

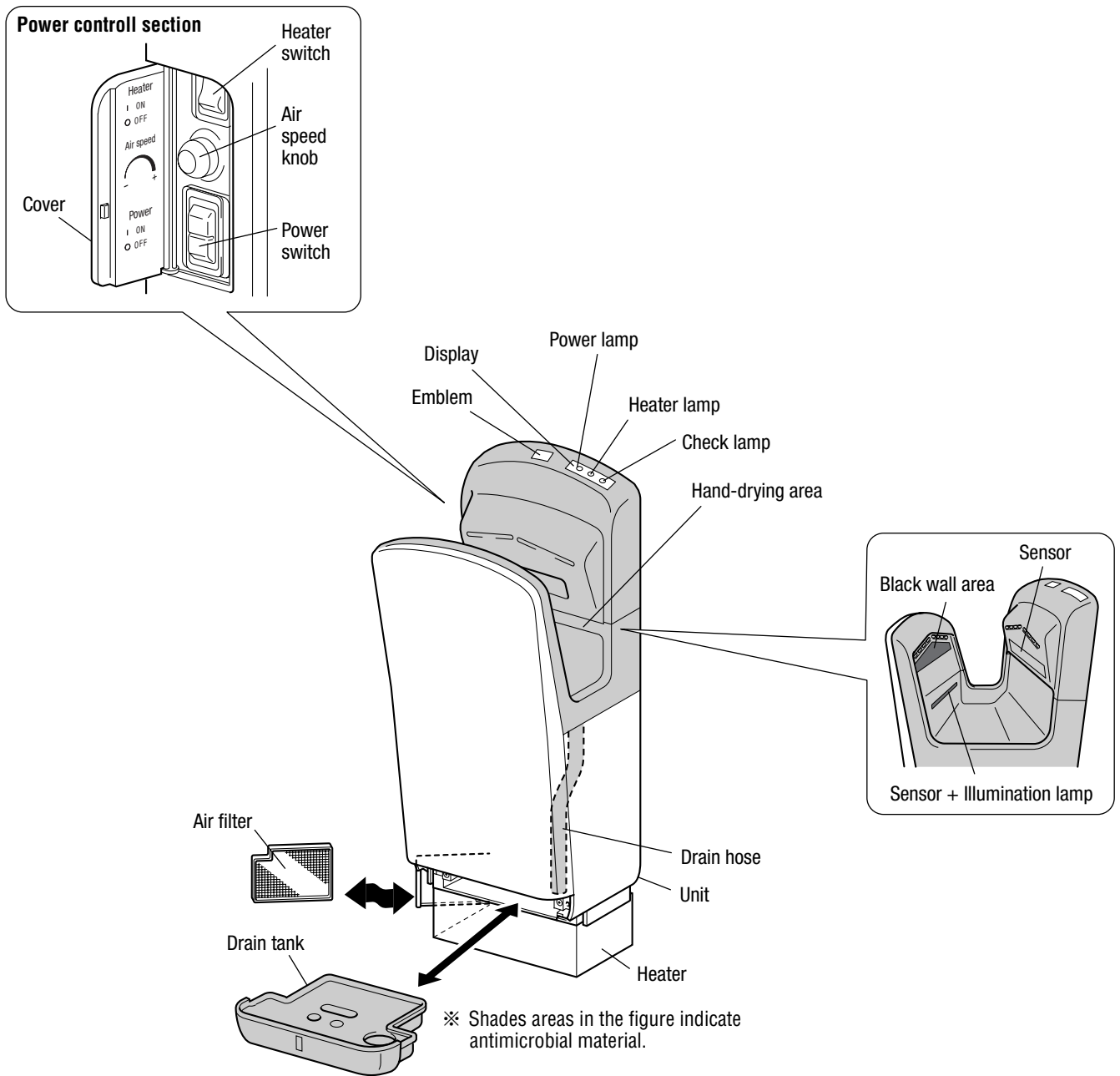

How to use the unit

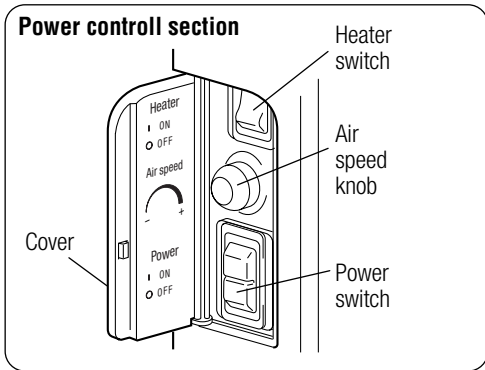

◆ Introduction

1. Open the power control section cover.
2. Turn on the power switch.

- Power lamp and heater lamp turn on. (Display)
- Emblem lamp turns on.
- Illumination lamp turns on.
- Adjust the Air speed knob to the best point.

Note:

- When the power switch is turned on, make sure to remove hands from the hand-drying area. Take sufficient care to avoid this because it may deteriorate the sensitivity of sensor.

3. Close the power control section cover.

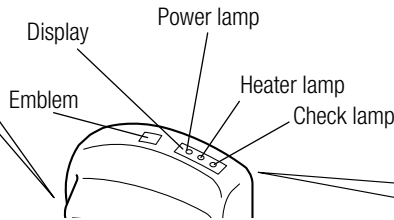

Display

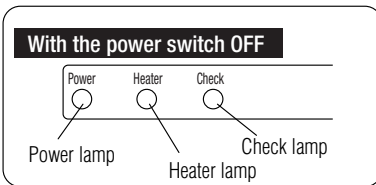
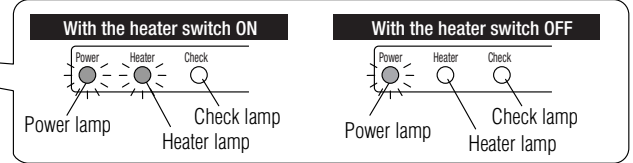

■ When not using the unit for long periods of time

Turn the power switch off.

The unit consumes approximately 2W of power even if unused when the power is on. (With the heater switch "OFF")

* When the heater switch is turned "ON", approx. 1,100 W of power is consumed to accumulate heat by operating the heater.

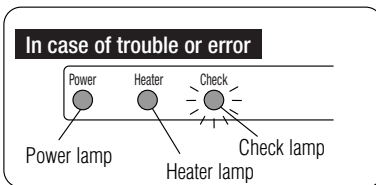

■ Check lamp

When a malfunction or error occurs, the check lamp on the right side of the display will either light up or flash. Turn the power switch off, wait approximately 40 seconds until the all the lamps in the display go off, and then turn the power back on. If the check lamp is still on or flashing, turn off the power, shut off the ground-fault circuit interrupter, and contact your dealer.

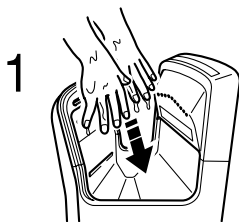

1 With both hands open, insert them all the way in. The unit will come on automatically.

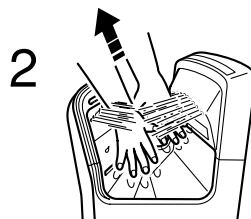

2 Pull them out slowly, letting the air blow the water off.

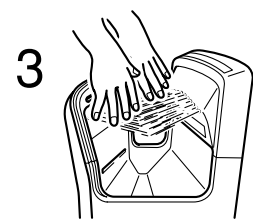

3 Pull hands all the way out.

Repeat until dry

● Information

As the hand dryer is open at both sides of the main unit, your hands may also be inserted from the sides. If your hands are inserted from the sides and pulled upwards a few times, you can dry your hands without any risk of water drops blowing upwards.

■ How to dry your hands



1 Insert from each side.

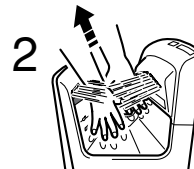

2 Bringing upwards slowly.

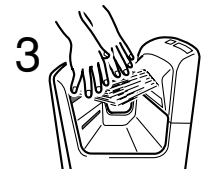

3 Pull out.

Maintenance

Maintenance and cleaning of the exterior

Before the unit starts looking too dirty



Warning



- Always turn off the power when cleaning the unit.
- Do not splash water on the unit.



Caution

- Wear gloves when cleaning.
- Wait till the heater exterior cools down before starting maintenance. (It may cause burn.)

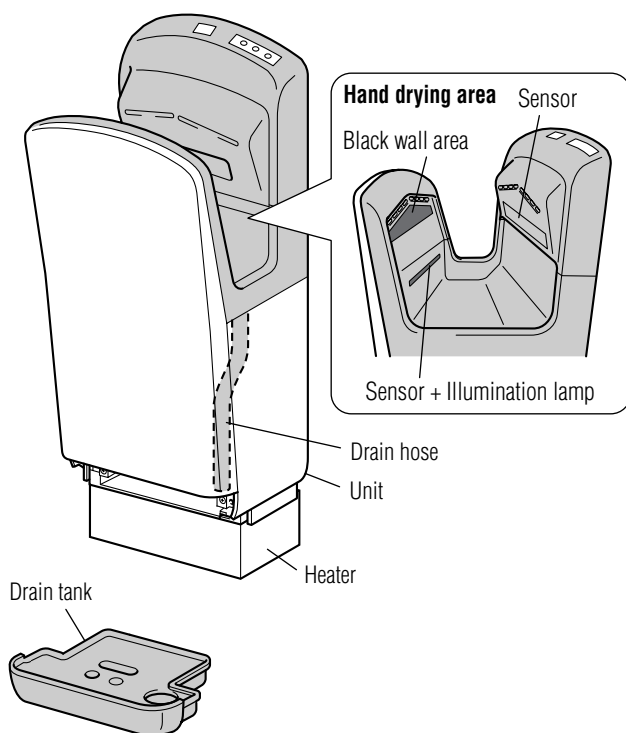

■ The antimicrobial material is effective when bacteria comes into contact with the surfaces (Shaded area in the figure at left).

■ If those surfaces are dirty the antimicrobial material will not be effective.

● Wipe with a well-wrung wet rag

If the unit is very dirty, dip a rag in a neutral cleaning agent and wipe, then wipe clean with a dry rag.

● **Remove dust from the sensor.** (To prevent malfunction.)



Note

- Only use neutral cleaning agents.
- Do not use thinner, benzene, or other acidic or alkaline toilet cleaners, or plastic scrub brushes. (These will damage the plastic and painted parts.)
- Only the hand-drying area can be cleaned with alcohol. (Do not use alcohol at any places other than the hand-drying area.)
 - * Alcohol means the sterilizing ethanol (concentration 83% or under).
 - * When cleaning the hand-drying area with alcohol, the alcohol may drop along the drain hose and accumulate in the drain tank. It could frost the drain window. Make sure to drain alcohol accumulated in the drain tank after cleaning with alcohol.
- Chemical cloths should be used as indicated in their instructions.
- Disinfecting agents will damage the product.
- When the power switch is turned on after cleaning, make sure to remove hands or any foreign substance from the hand-drying area. Otherwise, it may deteriorate the sensitivity of sensor.
When the sensor sensitivity has deteriorated, turn the power switch off once and back on again 40 seconds later.

Maintenance (Continued)

Cleaning of the hand drying area (Cleaning of the black wall area)

About once every week

1

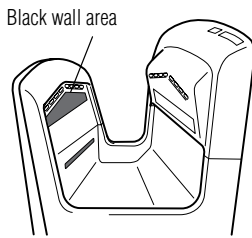

- Sensor's sensitivity may be reduced if the black wall area is fouled in white. Clean the area at least once a week according to the Maintenance and cleaning of the exteriors.

Draining and cleaning the drain tank

Before it fills up (at least once a week)

- The water blown off hands is called "drain water."
- Empty the drain tank at least once a week so that it does not reach the full line.
- If the drain tank is not emptied it will start smelling.

1

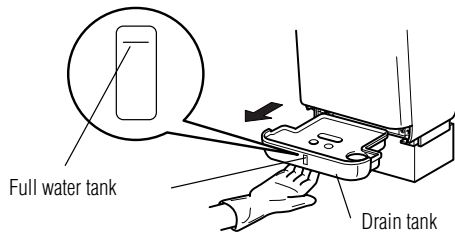

Pull the drain tank out horizontally.

- Make sure the drain water does not spill out.

2

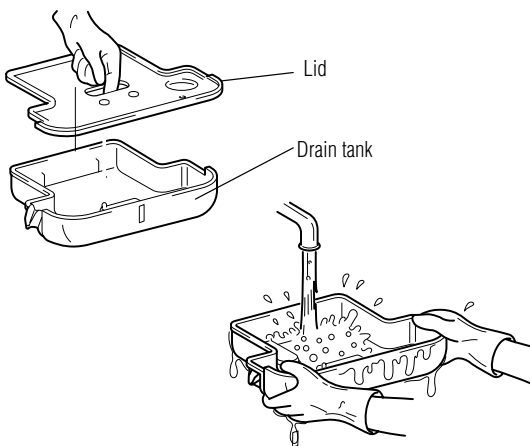

1. Open the lid and empty the drain water.

2. Wash out the interior of the drain tank.

3. Replace the lid and then the entire drain tank to its original location.

- Insert it securely all the way in the unit.

3



Pour 200ml (around 1 cup) of water through the drain hole. (To prevent it from getting clogged.)

- Do this only after checking that the drain tank is in place. (Empty beforehand the water accumulated in the drain tank)
- After repeating operations several times, make sure to empty the water accumulated in the drain tank.

Maintenance (Continued)

Cleaning the air filter

Around once a week

1

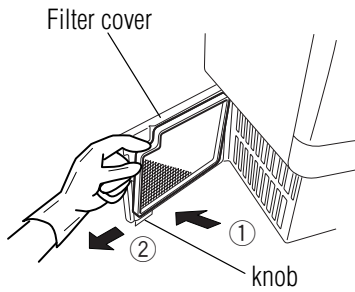

1. Open the filter cover.
 - Pull the knob.
2. Remove the air filter

2

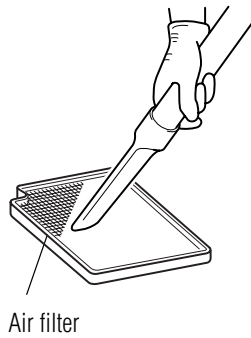

1. Clean the filter.
 - Pat it lightly by hand or use a vacuum cleaner.
 - If it is very dirty, wash it off with cold or lukewarm water.



Note

- If you washed the air filter with water, dry it thoroughly to remove all.
- Do not expose the air filter to flame under any circumstances whatsoever. (Filter may be deformed.)

3

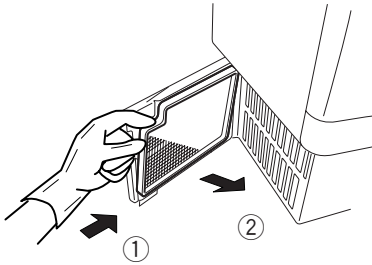

1. Reinstall the air filter as it was.
 - If the air filter will not insert in the panel, try to invert it. (Mounting direction is specified.)
2. Close the panel.
 - Unless the panel is closed, dust may be inhaled in, resulting in fire.

If you think something has gone wrong?

Perform the following checks and fixes.

Problem	Check	Fix
No air blows even if hands are inserted	Are any lamps in the display on? Has a blackout occurred?	<ul style="list-style-type: none"> ● Turn the ground-fault circuit interrupter on. ● Turn the power switch on.
	Are you putting your hands in all the way?	<ul style="list-style-type: none"> ● Place hands all the way in.
Air does not stop blowing	Hasn't the power switch been turned on while hands are inserted in the hand-drying area?	<ul style="list-style-type: none"> ● Turn OFF the power switch. After the power lamp at the display has turned off, remove foreign substances or fouling. Wait at least for 40 seconds and then turn the power switch to ON again.
	Is the sensor blocked by dirt or dust?	
Air does not stop blowing	Isn't the black wall area fouled in white in the hand-drying area?	
No hot air comes out	Isn't the heater switch turned OFF?	<ul style="list-style-type: none"> ● Turn the heater switch to ON.
Check lamp is flashing	Any problems with the power supply will cause the lamp to go on or flash.	<ul style="list-style-type: none"> ● Turn the power switch off, check that all the lamps in the display have gone off (around 40 seconds), and then turn the power back on.
During initialization, smoke and odors emanate from the hot air outlet vent.	This is due to oil and dust accumulated on the heater burning, and is not a malfunction.	
If the above fixes do not work, turn off the power and the ground-fault circuit interrupter and have your dealer inspect and if necessary repair the unit. (Costs are as per agreement with dealer.)		

Specifications

Model	Voltage	Frequency	Power input (W)	Current (A)	Weight (kg)	Dimensions (W × D × H)
JT-SB116EH-W-CA	120V	60Hz	1100	9.2	14	300 × 222 × 835 (mm)

- The drain tank capacity is 0.8 ℓ.