

HAND DRYER

HANDBOOK

MODELS

JT-SB116JH2-S-NA

JT-SB116JH2-W-NA

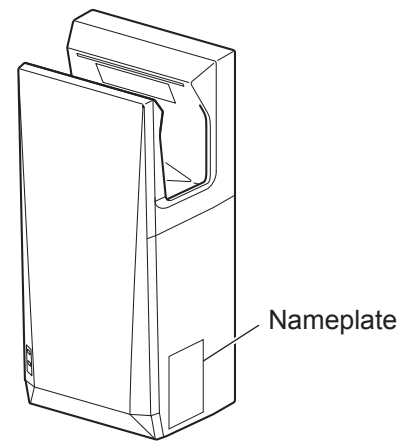

Warning:

Repair work must be performed by the manufacturer, its service agent or a similarly qualified person in order to avoid hazards.









MITSUBISHI ELECTRIC CORPORATION



Contents

1. Safety precautions	3-4
2. Features	4
3. Improved points	4
4. Names of components	5
5. Specifications	5
6. Outside dimensions	6
7. Electrical wiring diagram	6
8. Circuit board diagrams	7-9
9. Principles of operation	10
10. Troubleshooting	11-14
11. Before receiving repair requests	15
12. Service inspection list	15
13. Overhauling procedures	16-25
14. Parts catalog	26-42
JT-SB116JH2-S-NA	27-34
JT-SB116JH2-W-NA	35-42

1. Safety precautions

- Read the following precautions thoroughly before the maintenance, and then inspect and repair the product in a safe manner.
- The types and levels of danger that may arise if the product is handled incorrectly are described with the warning symbols shown below.

 Warning		Incorrect handling of the product may result in serious injury or death.	
<p>◇ Electric shock If you must inspect the circuitry while the power is on, do not touch the live parts.</p> <p>(Failure to heed this warning may result in electric shock.)</p> <div style="text-align: right;">  <small>Caution against electric shock</small> </div>	<p>◇ Turn off the power Make sure to turn off the circuit breaker prior to starting repair work. (The charge voltage in the circuitry remains for another 90 seconds or so, even after the power is turned off and the LED is unlit; therefore, wait for at least 90 seconds before disassembling the product.)</p> <p>(Failure to heed this warning may result in electric shock.)</p> <div style="text-align: right;">  <small>Be sure to follow this instruction.</small> </div>		
<p>◇ Modification is prohibited Do not modify the unit.</p> <p>(Failure to heed this warning may result in electric shock, fire and/or injury.)</p> <div style="text-align: right;">  <small>Prohibited</small> </div>	<p>◇ Use proper parts and tools For repair, be sure to use the parts listed in the service parts catalog of the applicable model and use the proper tools.</p> <p>(Failure to heed this warning may result in electric shock, fire and/or injury.)</p> <div style="text-align: right;">  <small>Be sure to follow this instruction.</small> </div>		
<p>◇ Proper electric work</p> <ul style="list-style-type: none"> • Use the electric wires designated for electric work, and conduct electric work in accordance with the "Electric Installation Engineering Standard", the "Indoor Wiring Regulations" and the installation instructions. • Make sure that the terminals and fixed wiring are securely connected. <p>(Improper connection or wiring installation may result in electric shock and/or fire.)</p> <div style="text-align: right;">  <small>Be sure to follow this instruction.</small> </div>	<p>◇ Check insulation Upon completing repair work, always measure the insulation resistance. Verify that it is at least 10 MΩ (with a 500-V DC insulation resistance tester), and then turn on the power.</p> <p>(Inadequate insulation may result in electric shock.)</p> <div style="text-align: right;">  <small>Be sure to follow this instruction.</small> </div>		
<p>◇ Scratches and deterioration Make sure to replace scratched and/or deteriorated wiring and lead wires.</p> <p>(Failure to heed this warning may result in electric shock and/or fire.)</p> <div style="text-align: right;">  <small>Be sure to follow this instruction.</small> </div>			

 Caution		Incorrect handling of the product may result in injury or damage to properties including buildings and equipment.	
<p>◇ Wear gloves Always wear a pair of gloves during inspection or repair work.</p> <p>(Failure to heed this caution may result in injury.)</p> <div style="text-align: right;">  <small>Be sure to follow this instruction.</small> </div>			

Notes for servicing

- Before repairs, take the product off the wall.
- Inspect the grounding condition, and repair it if it is incomplete. Make sure that a circuit breaker or an overload protection device is installed, if it is not installed, recommend the customer to install one.
- Check whether the air filter, side cover, and the drain tank are installed securely in place.
- Do not leave a towel or other objects in the hand-drying area.
- Never place any objects on the main body nor cover it.
- Make sure that the product is not being used in any of the following locations:
 - Outdoors
 - Locations where the temperature could be lower than 50°F (10°C)
 - Locations where the temperature could be higher than 104°F (40°C)
 - Locations where there is a lot of dust
 - Locations where there is a lot of condensation
 - Locations where salt damage could occur
 - In vehicles (including ships and airplanes)
 - Locations where corrosive, neutral, or reductive gases are present (This may shorten the working life of the unit and/or cause malfunctions.)
 - Near food or tableware
 - Kitchens (Where there is a risk of water splashing)
 - Locations where the product may come into direct contact with water
 - Locations where the product is in direct sunlight or strong light (It may cause sensor malfunction)
 - Near bathtubs, showers, or swimming pools
- Make sure that the product operates properly upon completion of repair. Clean the product and the surrounding area, and then notify the customer of the completion of repair.

2. Features

- Wide hand drying area: easy-to-use for people with big hands
- Child sensor: easy-to-use for children
- Cleanable drain ditch
- Exteriors can be cleaned by wiping with alcohol.
- The square design matches various lavatories.

3. Improved points

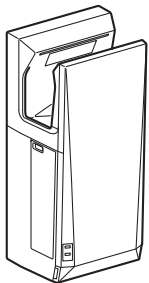
Item	Previous model	New model
		JT-SB116JH-G-NA JT-SB116JH-W-NA (With a simple heater)
Appearance		
Noise (dB)	61	59
Others	The maintenance switch is provided behind the service panel (switch door).	The maintenance switch and service panel (switch door) are not provided.

4. Names of components

*Shaded areas in the figure indicate antibacterial material.

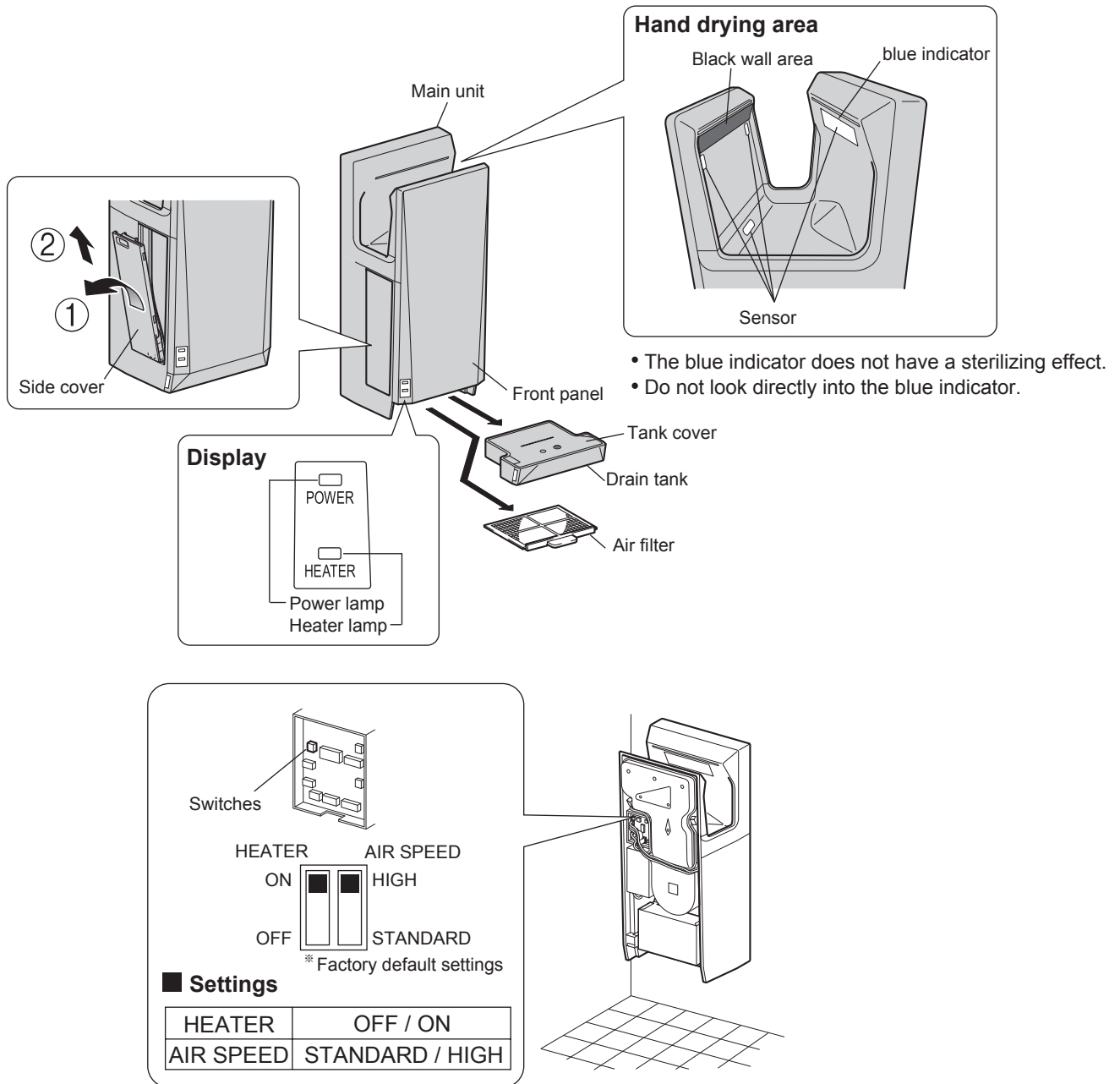

5. Specifications

Model	Rated voltage (Vac)	Rated frequency (Hz)	Rated current (A)	Air speed setting	Power consumption (W)		Air speed (m/h)	Noise (dB(A))	Weight	Drain tank capacity
					Heater ON	Heater OFF				
JT-SB116JH2-S-NA JT-SB116JH2-W-NA	120	60	11.4	HIGH	1250	730	235	59	26.5 lbs (12 kg)	1.7 pt (0.8 ℓ)
STANDARD				1090	570	215	56			

- Air speed is calculated from the static pressure measured by the pitot tube (at the nozzle).
- Sound is the A range value measured in an anechoic room. (Average of the three points: 78 3/4" (2 m) from the front and both sides of the unit.)
- The heater is turned off automatically when ambient temperature reaches 86°F (30°C).
- Compliance: Conforms to ANSI/UL Std. UL499

Certified to CAN/CSA Standard C22.2 No. 36

6. Outside dimensions

JT-SB116JH2-S-NA, JT-SB116JH2-W-NA

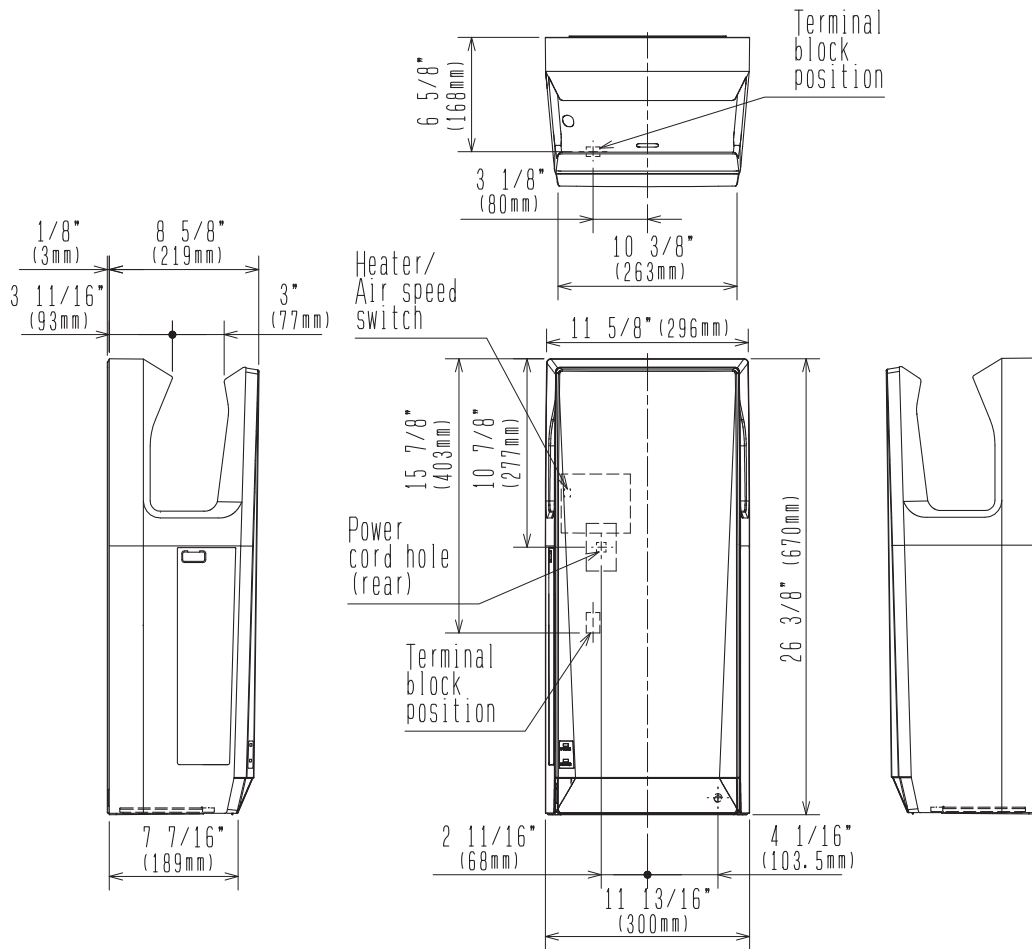

Unit: Inches (mm)

7. Electrical wiring diagram

JT-SB116JH2-S-NA, JT-SB116JH2-W-NA

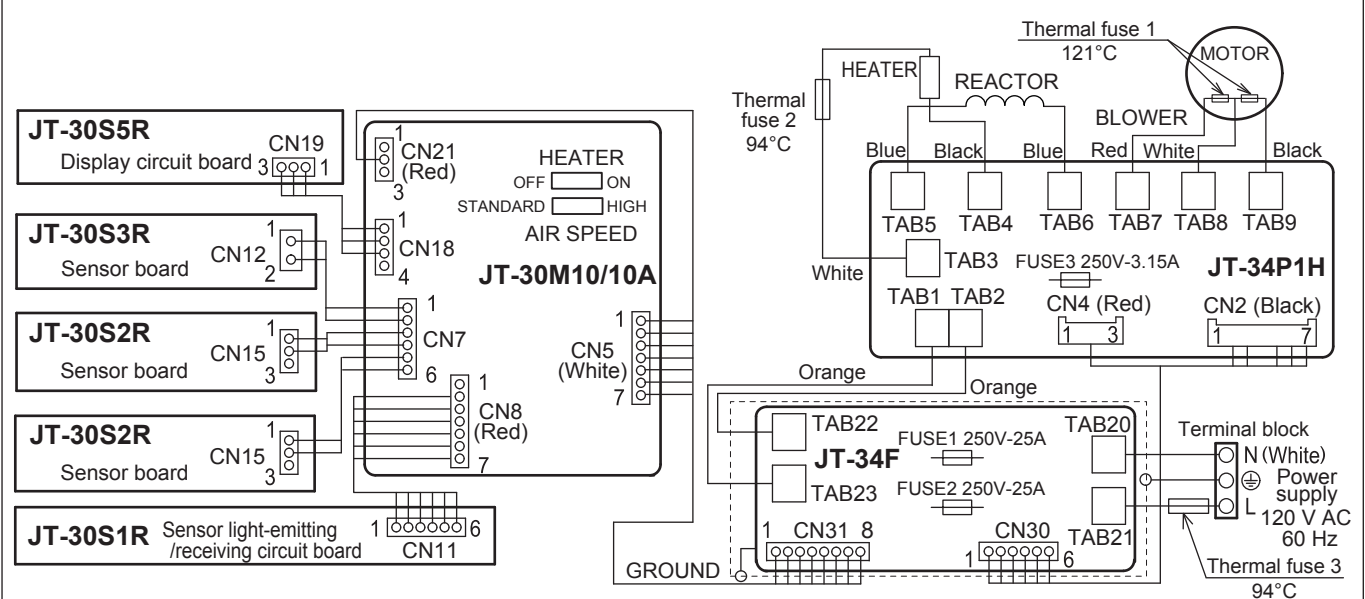

8. Circuit board diagrams

● Circuit board diagrams and check points

① Power circuit board (JT-34P1H)

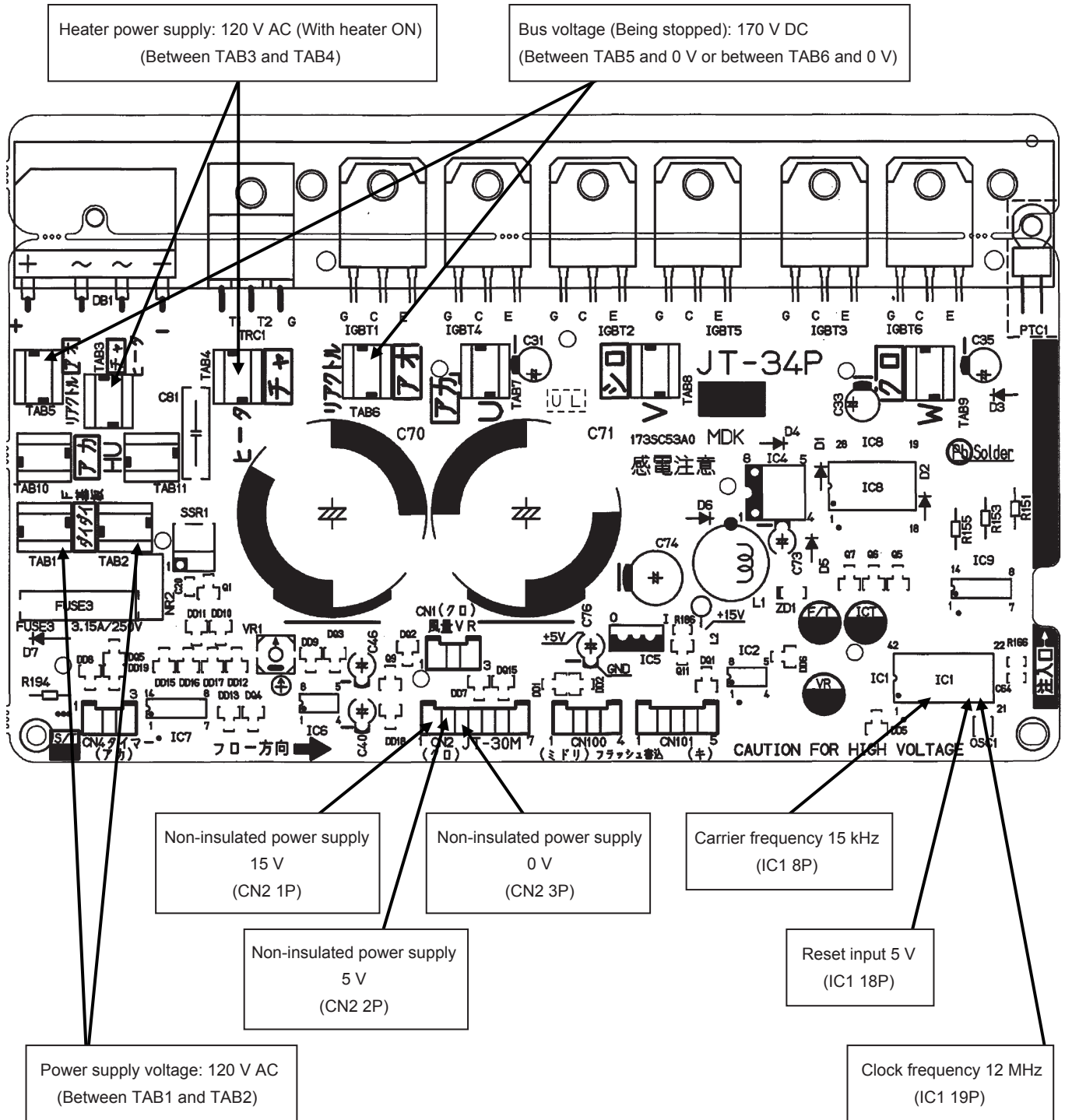

② Filter circuit board (JT-34F)

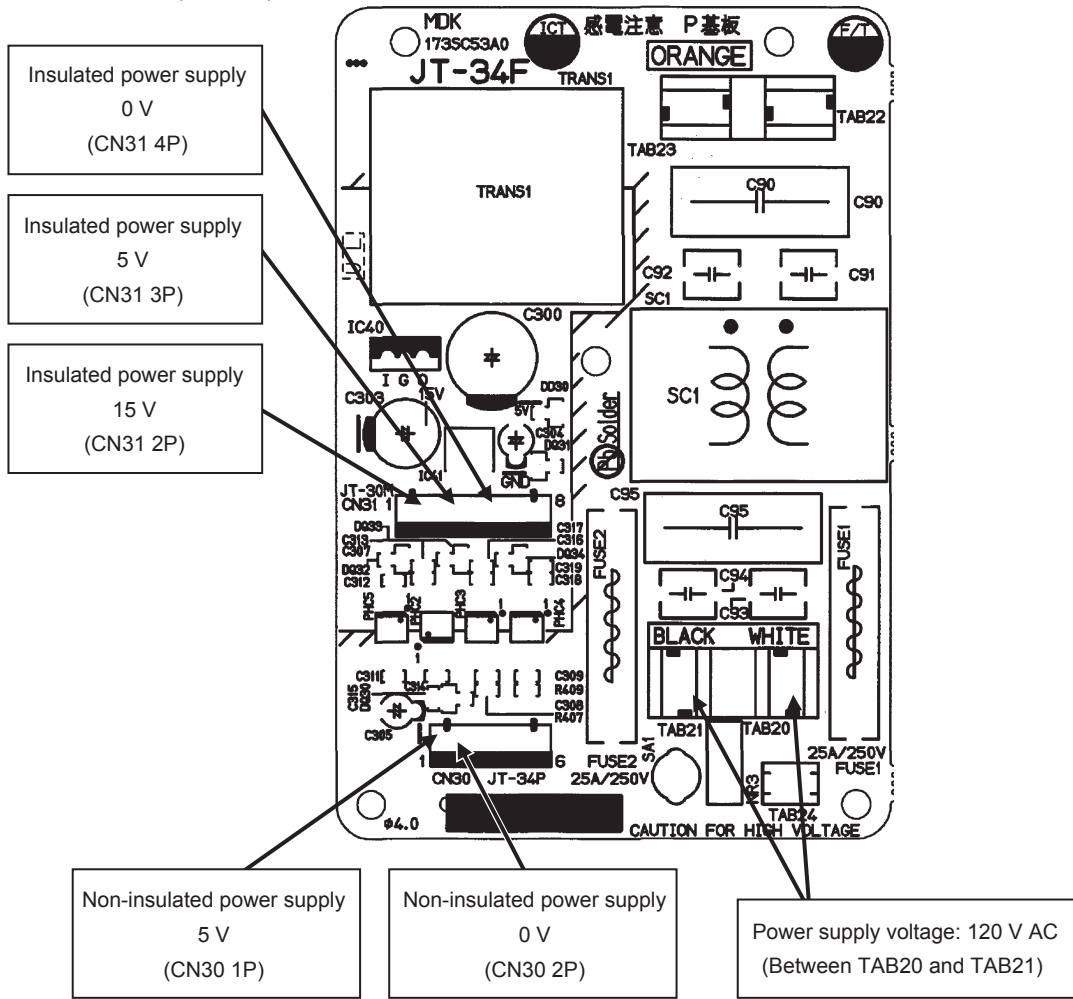

③ Control circuit board
(JT-30M10 [JT-SB116JH2-S-NA] / JT-30M10A [JT-SB116JH2-W-NA])

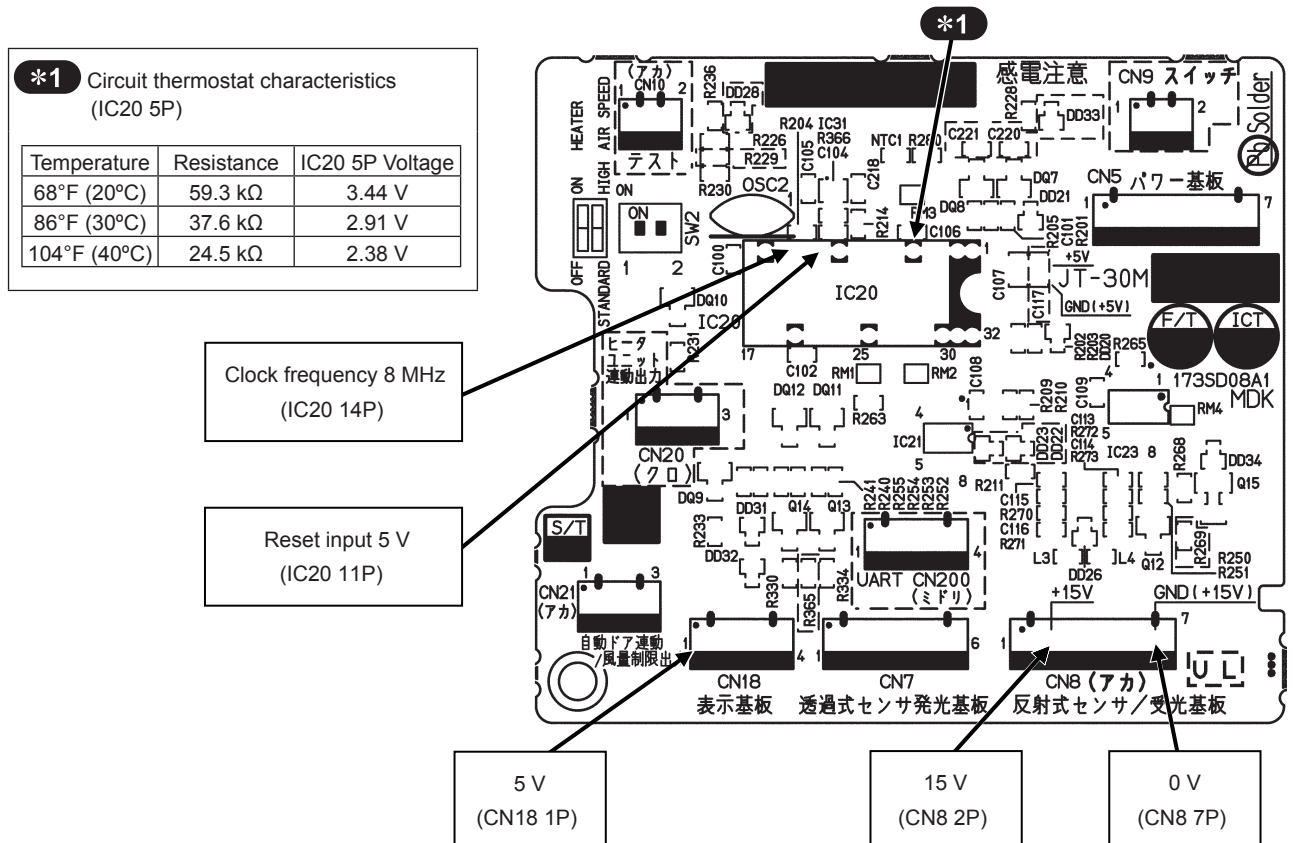

④ Light receiving circuit board (JT-30S1R) (Upper sensor)

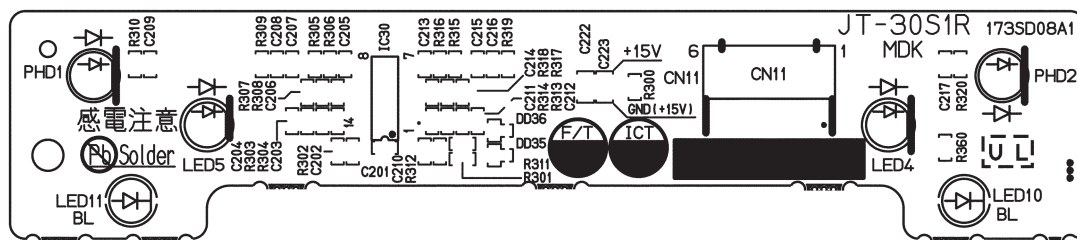

⑤ Sensor circuit board (JT-30S2R) (Middle sensor)

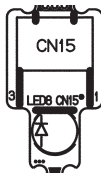

⑥ Sensor circuit board (JT-30S3R) (Lower sensor)

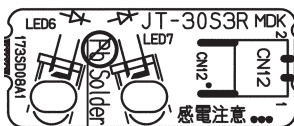

⑦ Display circuit board (JT-30S5R)

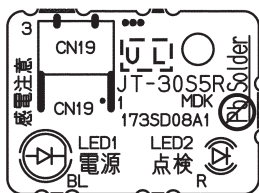

9. Principles of operation

● Descriptions of circuit operation

(1) Notes for turning the circuit breaker “ON / OFF”

- ① When the circuit breaker is turned “ON” and the power is supplied to the product, the power lamp (LED1), the heater lamp (LED2) (with the heater switch ON), and blue indicators (LED10, 11) turn on after 1.5 seconds^(*), and the hand dryer becomes ready for operation.
 - Before the power lamp turns on, the hand dryer will not operate even if hands are inserted in the hand drying area. In the meantime, the microcomputer (IC20) of the main unit performs the initial settings, including the setting of the hand detection sensor sensitivity.
 - In order to set the sensitivity of the hand detection sensor correctly, do not insert hands in the hand drying area until the power lamp is turned on.
 - Even if the hand dryer has started immediately (within 15 seconds or less) after turning the circuit breaker “ON”, it is normal though the motor input may become slightly lower due to the initial setting.

*1: If the circuit breaker is turned ON again 30 to 120 seconds after turning the circuit breaker OFF, it may take 3 seconds before the operation is enabled.
- ② When the circuit breaker is turned “OFF”, the power lamp and blue indicators turn off and operation stops.
 - The circuitry takes about 50 seconds to discharge the voltage retained in it. Wait until the discharging time elapses before plugging in or out the connectors, replacing the circuit boards, or doing other maintenance.
 - Even when any error is occurred, the error display will go off if the circuit breaker has been turned off. Only when a microcomputer error is occurred, the error display persists till the voltage retained in the circuitry has been discharged (till the microcomputer has been reset).

(2) Hand detection and operation

- ① The hand detection sensors are infrared sensors containing the light emitting sensor (infrared LED) and light receiving sensor (photo-diode), etc. and consist of the upper sensor, the middle sensors, and the lower sensor.
- ② Reflection type upper sensor:

This sensor detects the change in the reflected amount of infrared light when hands are inserted.

Transmission type middle and lower sensors:

These sensors detect that the infrared light is shielded when hands are inserted.
- ③ When the lower or middle sensors detect hands, the blower motor turns on and the hand dryer starts to operate.
- ④ Once operation has started, it continues as long as any of the upper, middle, or lower sensors detects hands.
- ⑤ If 1.5 to 3 seconds elapse without detecting hands by any of the sensors, the blower motor turns off and operation stops.
- ⑥ The hand dryer continuously operates for up to 30 seconds.
 - Once 30 seconds have elapsed, the hand dryer stops operating even if hands are detected.
 - Since this is a function to assume the presence of a foreign object, the operation will resume if hands are pulled out and reinserted.

(3) Control of the heater

- ① The heater turns ON simultaneously with the blower motor turns ON. (The heater lamp turns on.)
- ② The heater does not turn ON in the following occasions:
 - When the heater switch is turned “OFF”
 - When a temperature detected by the circuit thermostat on the control circuit board (JT-30M10/JT-30M10A) is 89.6°F (32°C) or higher

10. Troubleshooting

■ Work precautions

- When servicing, reproduce the malfunction two or three times before starting repairs.
- When servicing, always take care to keep proper footing.
- Before starting the service, always unplug the power cord from the outlet, or turn off the circuit breaker when no power cord plug is provided. Sufficient care must be taken to avoid electric shock or injury.
- Make sure to connect the power supply wires correctly.
- When removing the circuit board, always hold it at both ends and remove carefully so as not to apply force to the surface mounted parts.
- When removing the circuit board, be careful of the metal edges on the board.
- When removing or inserting the connectors for the circuit board, hold the entire housing section. Never pull on the lead wires.
- When circuit board failure is considered to be a cause, check closely for any broken section on the copper foil patterns, burning or discoloration of parts.
- After replacing a circuit board, make sure to restore the same settings as before the replacement.

* The part names in the text are standardized with the part names in the parts catalog. (There are some exceptions.)

(1) Table of the safety devices

Purpose	Device
Overcurrent protection	Current fuse
Protection against an excessive temperature rise of the heater parts	Thermal fuse
Protection against an excessive temperature rise of the blower parts	Thermal fuse
Motor lock protection	<ul style="list-style-type: none"> • Current detection circuit (Detects abnormal current caused by the motor lock, and stops the power to the motor.) • Current fuse

(2) Troubleshooting

Model name of the circuit boards

	JT-SB116JH2-S-NA	JT-SB116JH2-W-NA
Power circuit board	JT-34P1H	
Filter circuit board	JT-34F	
Control circuit board	JT-30M10	JT-30M10A
Light receiving circuit board	JT-30S1R	
Sensor circuit board	JT-30S2R	
Sensor circuit board	JT-30S3R	
Display circuit board	JT-30S5R	

Description of the error display

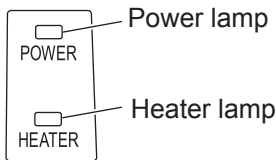

Malfunction location quick reference chart (The malfunction location is indicated by the lamp lighting status.)

○ : ON ☆ : Slow blinking (ON for 0.4 seconds/ OFF for 0.4 seconds)

● : OFF * : Fast blinking (ON for 0.1 second/ OFF for 0.1 second)

Power lamp	Heater lamp	Detected content	Cause
☆	○ or ●	Tamper-proof timer	Insertion of foreign objects, continuous operation
●	○	Overvoltage, undervoltage detection	Overvoltage impress, undervoltage impress, control circuit
○	☆	Motor lock error	Power circuit, blower
○	☆	Motor overspeed error, step-out error	Air filter, blower, power circuit
☆	☆	Overcurrent detected	Blower (short circuit), power circuit (overcurrent)
☆	☆	Motor current detection error	Power circuit, disconnected motor
●	☆	Motor signal error	Power circuit, disconnected motor
●	*	Microcomputer error	Control circuit
●	●	Fusing	Current fuse, thermal fuse in motor

Troubles with error display

Error Mode Display	Checkpoint	Check Method and Remedy				
<table border="1" style="width: 100%;"> <tr> <td style="text-align: center;">Power</td> <td style="text-align: center;">Heater</td> </tr> <tr> <td style="text-align: center;">●</td> <td style="text-align: center;">●</td> </tr> </table> <p>(Lamps do not light.)</p>	Power	Heater	●	●	Power supply voltage	<p>Check that approx. 120 V AC is supplied at both ends of the power cord connections on the terminal block.</p> <p>■ If 120 V AC is not supplied, check the following points.</p> <p>① Check that the circuit breaker is turned ON.</p> <p>② Check that the power cord is connected securely to the terminal block.</p>
Power	Heater					
●	●					
	Power supply voltage on the power circuit board	<p>Check that approx. 120 V AC is supplied between TAB1 and TAB2 (orange) on the power circuit board.</p>				
	●If 120 V AC is not supplied, check the following points.					
	Power supply voltage on the filter circuit board	<p>Check that approx. 120 V AC is supplied to the following points in the order of ① and ②.</p> <p>① Between TAB20 and TAB21 (white and black) If approx. 120 V AC is not supplied, check the power supply voltage of the circuit breaker.</p> <p>② Between TAB22 and TAB23 (orange) If approx. 120 V AC is not supplied, replace the filter circuit board.</p>				
	●When 120 V AC is supplied, check the following points.					
	Connector disconnection for the display circuit board	<p>Check if the connector CN19 on the display circuit board or CN18 on the control circuit board is disconnected.</p>				
	Connector disconnection between the circuit boards	<p>Check if the connector CN2 on the power circuit board, CN5 on the control circuit board, or CN30 or CN31 on the filter circuit board is disconnected.</p>				
	Malfunction of the control circuit board	<p>If no error is found after checking the above, replace the control circuit board.</p>				
	Malfunction of the power circuit board	<p>If the hand dryer does not operate even after replacing the control circuit board, replace the power circuit board.</p>				

Error Mode Display		Checkpoint	Check Method and Remedy
Power ☆	Heater ○ or ●	Dirty sensor window	Dirt may shield the sensors. Wipe the dirt off the sensor window.
(Tamper-proof timer)		Remaining foreign object	Check for any objects left over and shielding the sensor in the hand drying area.
		Connector disconnection for the sensors	Check if the following connectors are disconnected. ① Sensor circuit board (JT-30S3R) connector CN12 ② Sensor circuit board (JT-30S2R) (2 locations) connectors CN15 ③ Light receiving circuit board connector CN11 ④ Control circuit board connectors CN7 and CN8
		Malfunction of the control circuit board	If no error is found after checking the above, replace the control circuit board.
Power ○	Heater ☆	Motor malfunction	Check that the motor is not locked and turns smoothly by hand.
(Motor step-out) (Motor lock) (Motor overspeed)		Malfunction of the power circuit board	If no error is found after checking the above, replace the power circuit board.
		Blower (assembly) malfunction	If the error display persists after replacing the power circuit board, replace the blower (assembly).
Power ☆	Heater ☆	Motor overload	Check for causes of motor overload. (Too much higher power supply voltage, any object disturbing the motor revolution, etc.)
(Motor current detection error)		Connector disconnection for the motor	Check if the motor lead wire connectors (black, white, and red) are disconnected.
		Blown thermal fuse of the motor	Measure the resistance between Red and White and between Red and Black of the motor lead wires. If it is $\infty \Omega$, replace the blower (assembly).
		Malfunction of the power circuit board	If no error is found after checking the above, or if the error display persists after replacing the blower (assembly), replace the power circuit board.
Power ●	Heater ○	Abnormal power supply voltage	Check that correct power supply voltage is applied. • The error will occur if the power supply voltage is approx. 170 V AC or over, or approx. 60 V AC or under. *Note: If 170 V AC or over is applied, a current fuse on the power circuit board may blow.
(Overvoltage/Undervoltage detection)		Malfunction of the power circuit board	If no error is found after checking the above, replace the power circuit board.
		Connector disconnection	Check if the connector CN5 on the control circuit board, CN2 on the power circuit board, or CN30 or CN31 on the filter circuit board is disconnected.
Power ●	Heater ☆	Malfunction of the control circuit board	If no error is found after checking the above, replace the control circuit board.
(Motor signal error)		Malfunction of the control circuit board	Replace the control circuit board.
Power ●	Heater *	Malfunction of the control circuit board	Replace the control circuit board.
(Microcomputer error)			

Troubles without error display

Symptom	Cause	Check Method and Remedy
Warm air does not blow.	Heater switch	Check that the heater switch is turned ON. (Heater lamp lights with the heater switch ON.)
	Connector disconnection for the heater	Check if the connectors TAB3 and TAB4 on the power circuit board are disconnected.
	Blown thermal fuse of the heater	Measure the resistance between the connectors TAB3 and TAB4 on the power circuit board. If the fuse is blown, the resistance will be $\infty \Omega$. In this case, replace the heater (PTC) and the power circuit board.
	Malfunction of the power circuit board	Check that approx. 120 V AC is output at both ends of the connectors TAB3 and TAB4 on the power circuit board. If it is not output, replace the power circuit board. *Note: Approx. 120 V AC is output during operation, and it is not output during standby.
	Heater malfunction	If no error is found after checking the above, replace the heater (PTC).
The hand dryer operates by itself. The hand dryer does not stop operation.	Connector disconnection for the sensors	Check if the following connectors are disconnected. ① Sensor circuit board (JT-30S3R) connector CN12 ② Sensor circuit board (JT-30S2R) (2 locations) connectors CN15 ③ Light receiving circuit board connector CN11 ④ Control circuit board connectors CN7 and CN8
	Malfunction of the sensor circuit boards (JT-30S1/2/3R)	Visually check the sensor circuit boards for a defect such as a crack, corrosion, or a cold solder joint. If the error persists after replacing the control circuit board in the next procedure, replace the damaged sensor circuit boards.
	Malfunction of the control circuit board	If no error is found after checking the above, replace the control circuit board.
Air speed switch does not change the air volume.	Connector disconnection	Check if the connector CN21 on the control circuit board, CN4 on the power circuit board, or CN30 or CN31 on the filter circuit board is disconnected.
	Malfunction of the power circuit board	If no error is found after checking the above, replace the power circuit board.
The hand dryer makes abnormal noises. Air blow is weak.	Sucking of foreign matter	Check for any foreign matter sticking to the blower (assembly) vanes.
	Clogged filter	Check the filter for clogging with dust, etc.
	Incorrect wiring	Check if the motor lead wires of the blower (assembly) (red to TAB7, white to TAB8, black to TAB9) are connected to incorrect TABs on the power circuit board. (If they are connected incorrectly, the motor turns in the reverse direction.)
	Malfunction of the power circuit board	If no error is found after checking the above, replace the power circuit board.

11. Before receiving repair requests

Frequently asked question	Response
Air blow is too weak to dry hands quickly.	① Check if the filter is clogged. ② Isn't the air speed switch set at the STANDARD position?
Water leaks from the product.	① Check if the drain tank is filled up. (Empty the drain tank.) *Note: Drain water will overflow onto the floor when the drain tank is filled up beyond its capacity. ② Is the drain tank installed properly?
Air does not blow immediately after turning on the power and inserting hands.	Initial setting takes 1.5 seconds after turning on the power. Operation is disabled in the meantime.
Warm air does not blow.	① Is the heater switch turned ON? ② Is the room temperature lower than 89.6°F (32°C)?
The product has an abnormal odor.	① Check if the drain tank is filled up. (Empty the drain tank.) ② Check the inside of the drain tank for any foreign matter. (Remove it.) ③ Is the inside of the side cover cleaned up?

12. Service inspection list

Location	Inspection Item	Check Result
Electric wiring	Are lead wire connectors connected securely?	
	Is the wiring correct?	
Lamps	Do the power lamp (LED1), the heater lamp (LED2) (with the heater switch ON), and blue indicators (LED10, 11) come on?	
Operation	Does it operate properly? Isn't there any abnormal noise, vibration, etc?	
Heater	Is warm air blown?	
Wall installation	Isn't there clearance between the product and the back wall?	

13. Overhauling procedures

■ Work precautions

- Before replacing parts, follow the instructions described in the troubleshooting.
- When servicing, always take care to keep proper footing.
- Before starting the service, always unplug the power cord from the outlet, or turn off the circuit breaker when no power cord plug is provided. Sufficient care must be taken to avoid electric shock or injury.
- Make sure to connect the power supply wires correctly.
- After completing repairs, check that the unit operates properly.
- * Always wear gloves when servicing.
- * The part names in the text are standardized with the part names in the parts catalog. (There are some exceptions.)

<Internal view and circuit board locations>

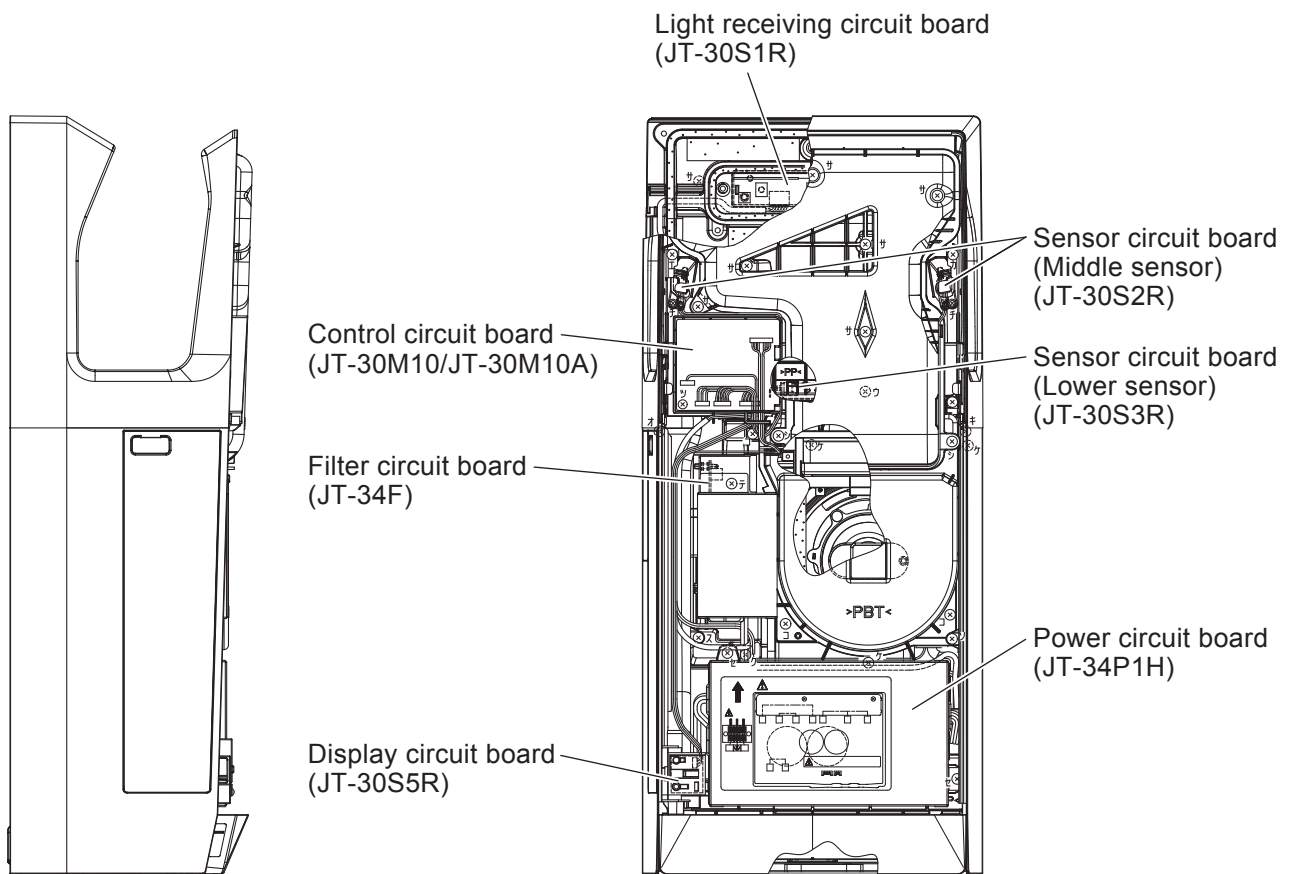

The following pictures show JT-SB116JH2-W-NA.

(1) Turn off the power supply.

- ① Stop the operation.
- ② Turn off the circuit breaker on the distribution board.

(2) Front panel

- ① Draw out the tank assembly (assy).

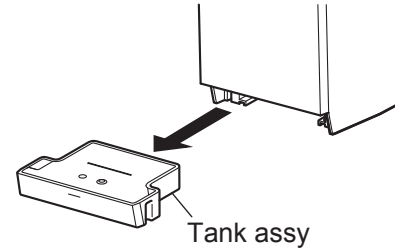

- ② Unscrew the clamping screws, and remove the front panel.
(Two special (spl) screws 4×16, indicated by ○)

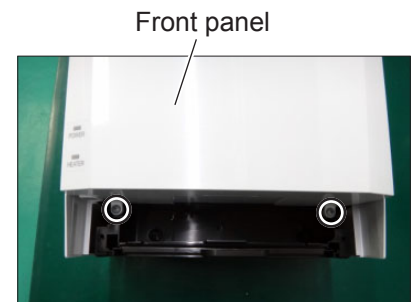

(3) Power cable

- ① Unscrew the clamping screw, and remove the terminal block (TB) cover.
(One PTT screw 4×6, indicated by ○)

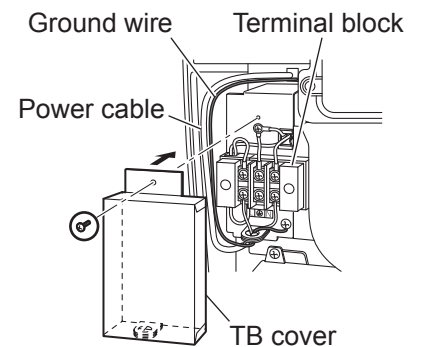

- ② Unscrew the clamping screws, and disconnect the power cable leads.
(Two screws, indicated by ○)

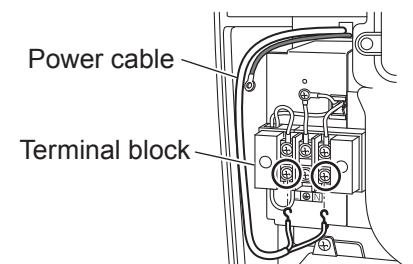

(4) Light receiving circuit board (JT-30S1R)

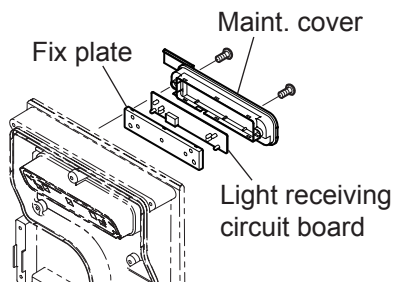

- ① Unscrew the clamping screws, and remove the maintenance (maint.) cover.
(Two spl screws 4 x 16, indicated by ○)

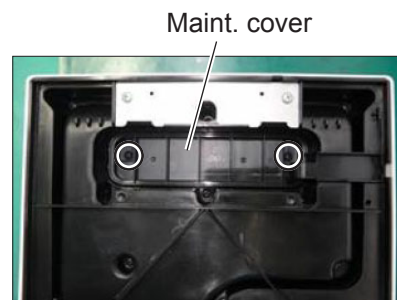

Assembly precaution
Insert the maint. cover into the groove of the base. (Indicated by ○)



- ② Remove the fix plate.

Assembly precautions

- Run the lead wires through the groove of the maint. cover. (Indicated by ○)
- Take care not to pinch the lead wires.



- ③ Remove the light receiving circuit board (JT-30S1R).



Light receiving circuit board (JT-30S1R)

(5) Control circuit board (JT-30M10/JT-30M10A)

- ① Disconnect the lead wires from the control circuit board.
- ② Unscrew the clamping screw, and remove the control circuit board (JT-30M10/JT-30M10A).
(One spl screw 4×12, indicated by ○)

Assembly precaution
Take care not to pinch the lead wires.

Control circuit board
(JT-30M10/JT-30M10A)

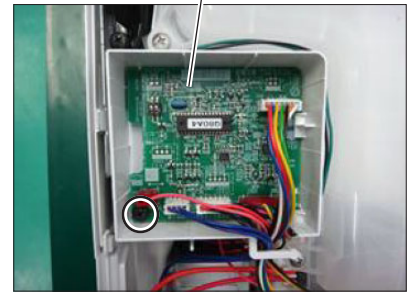

(6) Sensor circuit board (Middle sensor) (JT-30S2R)

- ① Unscrew the clamping screws for the panel holders left (L) and right (R).
(Two PTT screws 4×16, indicated by ○)
- ② Unscrew the clamping screws for the fix pieces.
(Two spl screws 4×12, indicated by △)
- ③ Slightly push aside the panel holders to take out the fix pieces. (Two locations)

Fix piece

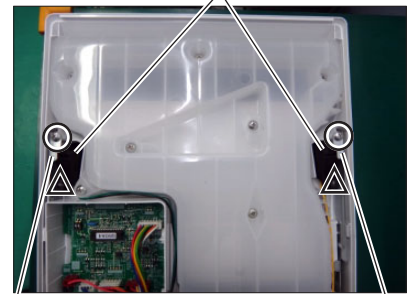

Panel holder L

Panel holder R

- ④ Remove the sensor circuit boards (JT-30S2R) from the fix pieces.

Assembly precautions

- Insert the sensor circuit board between the claws of the fix piece.
- Take care not to pinch the lead wires.
- After installing the circuit board, make sure that the LED is upright.

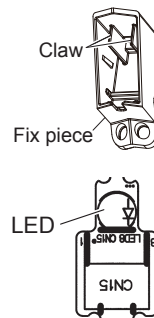

Fix piece



Sensor circuit board (JT-30S2R)

(7) Power circuit board (JT-34P1H)

- ① Unscrew the clamping screws, and remove the circuit board (PCB) cover.
(Two PTT screws 4×16, indicated by ○)

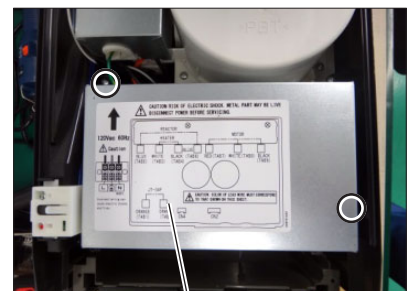

PCB cover

- ② Disconnect the lead wires from the power circuit board (JT-34P1H), and remove the power circuit board.

Assembly precautions

- When attaching the PCB cover, take care not to pinch the lead wires.
- Connect the lead wires as printed on the power circuit board.

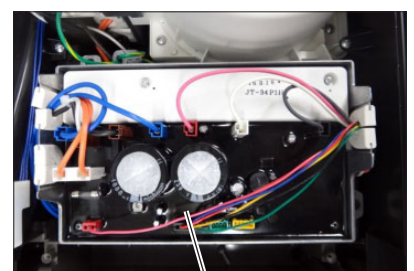

Power circuit board (JT-34P1H)

(8) Filter circuit board (JT-34F)

- ① Unscrew the clamping screw, and remove the terminal block (TB) cover.
(One PTT screw 4×6, indicated by ○)

Precaution

Pay attention not to pull the ground wire, which is threaded through the cord bush of the TB cover.

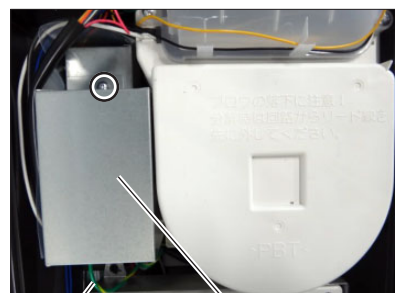

Ground wire TB cover

- ② Unscrew the clamping screw, and disconnect the ground wire.
(One PT screw 4×8 BS, indicated by ○)
- ③ Unscrew the TB fix plate clamping screw, and remove the terminal block parts.
(One PTT screw 4×16, indicated by △)

TB fix plate Terminal block

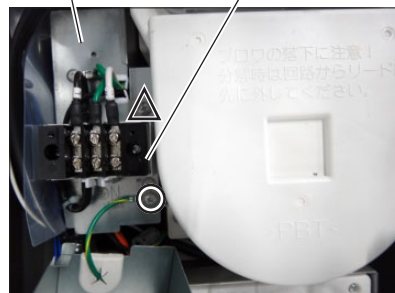

- ④ Unscrew the clamping screw, and remove the PCB cover.
(One PTT screw 4×6, indicated by ○)

Assembly precaution

Install the PCB cover over the TB fix plate.

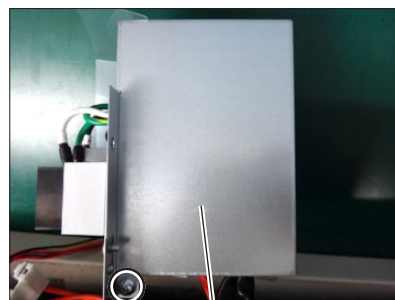

PCB cover

- ⑤ Disconnect the lead wires from the filter circuit board.
- ⑥ Remove the spacers (four locations, indicated by ○), and then remove the filter circuit board (JT-34F).
(Pinch the spacers from the back for easier removal.)

Assembly precaution

Run the lead wires through the cord bushes. (Indicated by □)

TAB20 TAB21

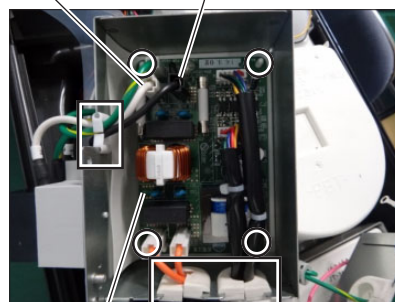

Filter circuit board (JT-34F)

(9) Display circuit board (JT-30S5R)

- ① Remove the PCB cover for the power circuit board.
→ See (7) ①.
- ② Unhook the claw of the LED holder, and slide the LED holder in the direction of the arrow, and remove it.

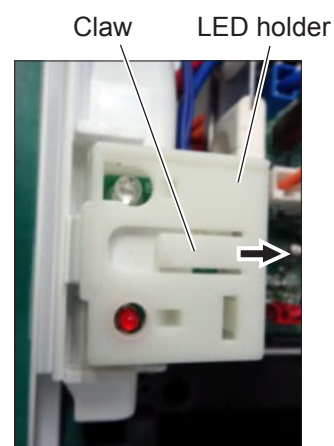

- ③ Remove the display circuit board (JT-30S5R) from the LED holder.

Assembly precautions

- Take care not to pinch the lead wires.
- After installing the circuit board, make sure that the LEDs can be seen through the holes of the LED holder.

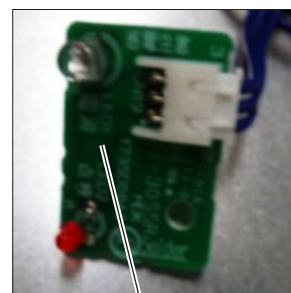

Display circuit board (JT-30S5R)

(10) Terminal block (with the thermal fuse)

- ① Unscrew the clamping screws, and remove the terminal block.
(Two PPT screws 4×20, indicated by ○)
- ② Disconnect the white lead wire (N) (TAB20) and black lead wire (L) (TAB21) from the filter circuit board. → See (8) ④ and ⑤.

Assembly precaution

When running the lead wire through the groove of the TB holder, set the thermal fuse in the center of the groove. (Indicated by ○)

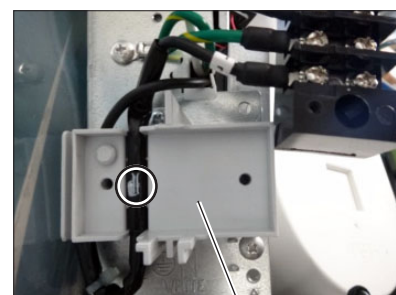
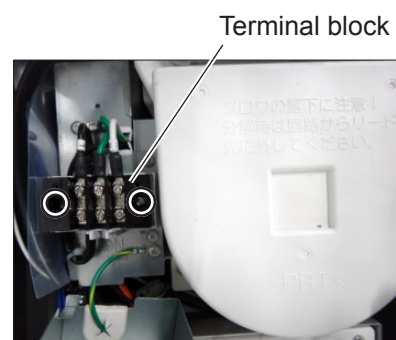

TB holder

(11) Heater (PTC)

- ① Unscrew the side panel left (L) and right (R) clamping screws.
(Two PTT screws 4×16, indicated by ○)



- ② Remove the side panel L in the direction of the arrow.

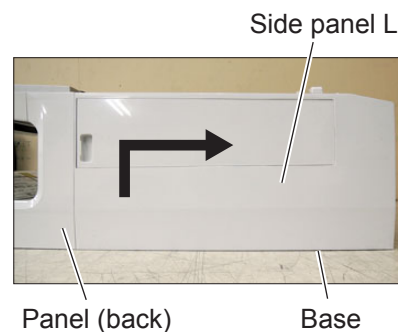

Assembly precautions

- Install the side panel L after installing the PCB cover for the power circuit board.
- Take care not to pinch the lead wires.
- Fit the side panel L into the groove of the panel (back) and the base.

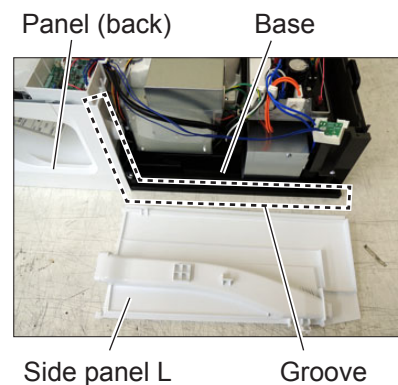

- ③ Remove the side panel R in the direction of the arrow.

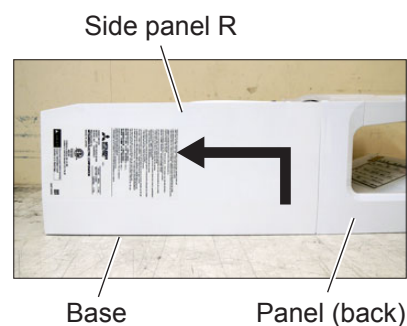

Assembly precaution

- Fit the side panel R into the groove of the panel (back) and the base.

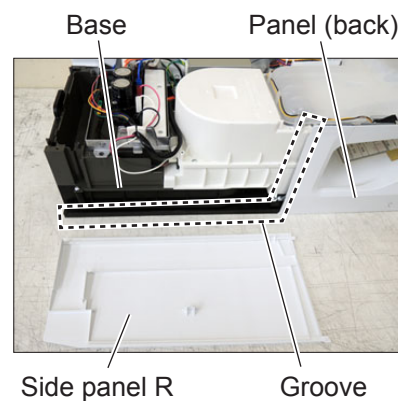

- ④ Unscrew the clamping screws, and remove the exhaust duct.
(Nine PTT screws 4×16, indicated by ○)

Assembly precautions

- Replace the packing used in the disassembled section with a new one.
- Take care not to twist the packing when installing it.

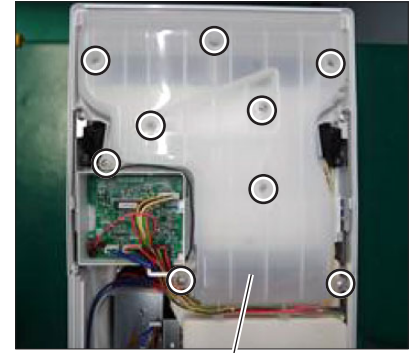

Exhaust duct

- ⑤ Unscrew the clamping screws, and remove the blower cover.
(Four PTT screws 4×16, indicated by ○)

Precaution

- Since the blower (assy) may drop off the blower case, remove the lead wires first, and then slowly remove the blower cover.

Assembly precautions

- Replace the packing used in the disassembled section with a new one.
- Take care not to twist the packing when installing it.

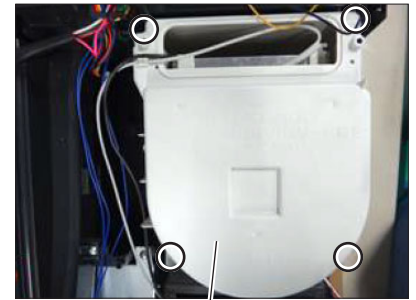

Blower cover

Assembly precaution

When replacing the heater, attach the included fixing piece to the position, indicated by △, with the included screw (one PTT screw 4×16) to prevent the blower from dropping off.

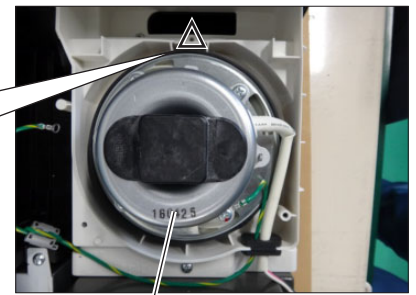
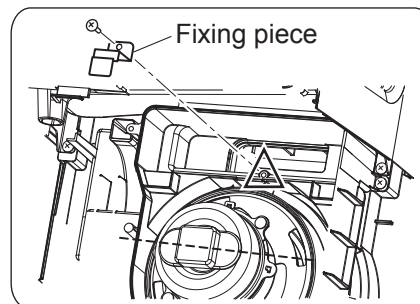

Blower (assy)

- ⑥ Unscrew the clamping screws, and remove the heater (PTC).
(Two PTT screws 4×16, indicated by ○)

Assembly precaution

When installing the heater, set the heater as the lead wire comes out from the right side.

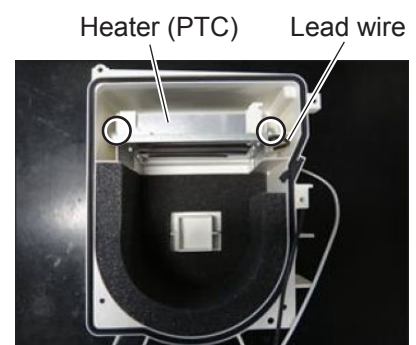

Assembly precautions

- Hook the lead wire into the rib of the blower cover. (Indicated by ○)
- Run the lead wires through the grooves of the blower cover. (Indicated by □)
- Make sure to match the size of the grooves and lead wires.
- Take care not to pinch the lead wires.

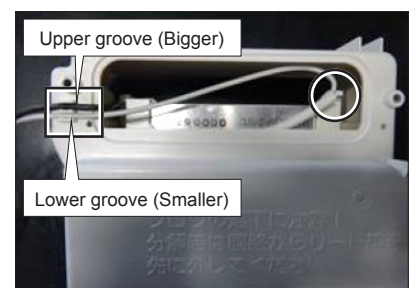

(12) Blower assembly (assy)

- ① Remove the blower cover. → See (8) ① to ②, (11) ① (Remove the side panel R clamping screw only), and ④ to ⑤.

Precaution

Since the blower (assy) may drop off the blower case, remove the lead wires first, and then slowly remove the blower cover.

- ② Remove the blower (assy).

Assembly precautions

- When replacing the blower (assy), attach the included fixing piece to the position, indicated by ○, with the included screw (one PTT screw 4×16).
- Set the blower (assy) as the lead wire outlet comes to the position indicated by △.
- The part of the lead wires covered with the white cord tube must pass through the cord bush. (Indicated by □)

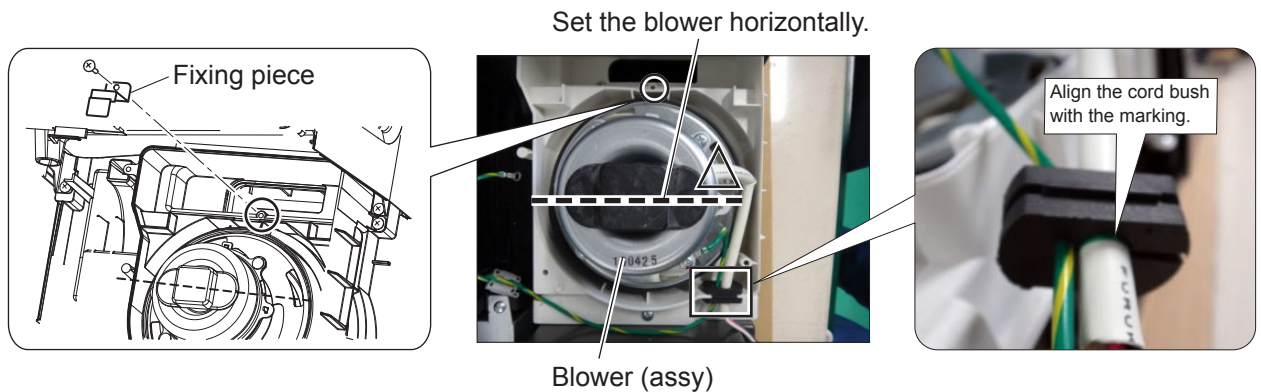

(13) Sensor circuit board (Lower sensor) (JT-30S3R)

- ① Remove the blower (assy). → See (7) ① and (12).
- ② Unscrew the clamping screws, and remove the blower case. (Three PTT screws 4×16, indicated by ○)

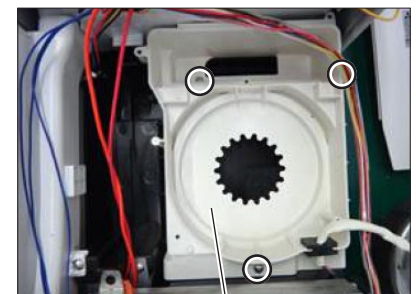

Blower case

- ③ Unscrew the panel (front) and panel holder clamping screws, and remove the panel holders L and R. (Five PTT screws 4×16, indicated by ○)

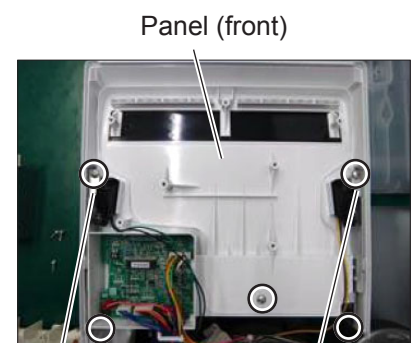

Panel (front)
Panel holder L Panel holder R

- ④ Tilt the panel (front) in the direction of the arrow, and remove it.

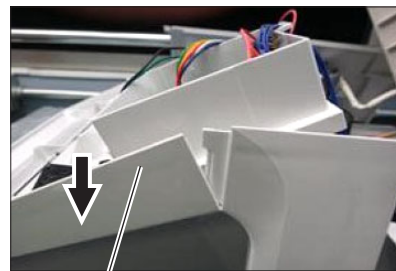

Panel (front)

- ⑤ Remove the sensor holder.

Assembly precaution
Take care not to pinch the lead wires.

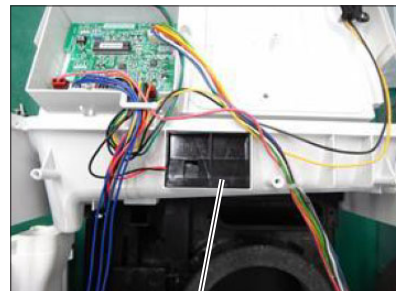

Sensor holder

- ⑥ Unhook the claw of the sensor holder (one location, indicated by ○), and remove the sensor circuit board (JT-30S3R).

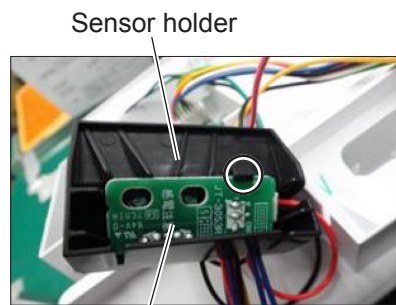

Sensor circuit board (JT-30S3R)

* When reassembling

- Reassemble the unit in the reverse order of disassembly.
- After reassembly, always make a test run to be sure that the unit operates properly.

14. Parts catalog

Please note the following when using the parts catalog.

1. When ordering parts, always indicate the part number, part name, and the number of parts required.
2. It may take time for you to receive the parts. Make an inquiry about a rush order.
3. Specifications may be subject to change without notice.
4. Parts marked with \triangle and are critical for safety.
5. To maintain safety and performance, always replace the parts with the parts prescribed.
6. When replacing the parts to which the nameplate is attached, remove the nameplate and attach it to the new parts.

Description of screw abbreviations

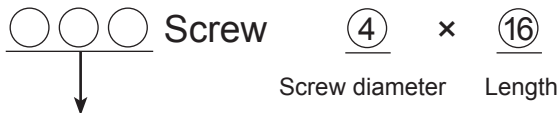

Abbreviation	Description
PC screw	Cross recess flat head machine screw
PRC screw	Cross recess oval head machine screw
PP screw	Cross recess pan head machine screw
SW · PP screw	Cross recess pan head screw with spring washer
PPT screw	Cross recess tapping screw
PCT screw	Cross recess flat head tapping screw
PTT screw	Cross recess truss head tapping screw
PT screw	Cross recess truss head machine screw
SET screw	Slotted head stop screw
SQ · SET screw	Square head stop screw
P · SET screw	Pan head stop screw
PMT screw	Primer truss head screw
HS · SET screw	Hexagon head stop screw
P · R · W screw	Cross recess round wood screw
P · C · W screw	Cross recess flat head wood screw
P · R · C · W screw	Cross recess round and flat wood screw
R · W screw	Slotted round wood screw
PW · PP screw	Cross recess pan head screw with small washer
SW-PW · PP screw	Cross recess pan head machine screw with spring washer and flat washer

JT-SB116JH2-S-NA

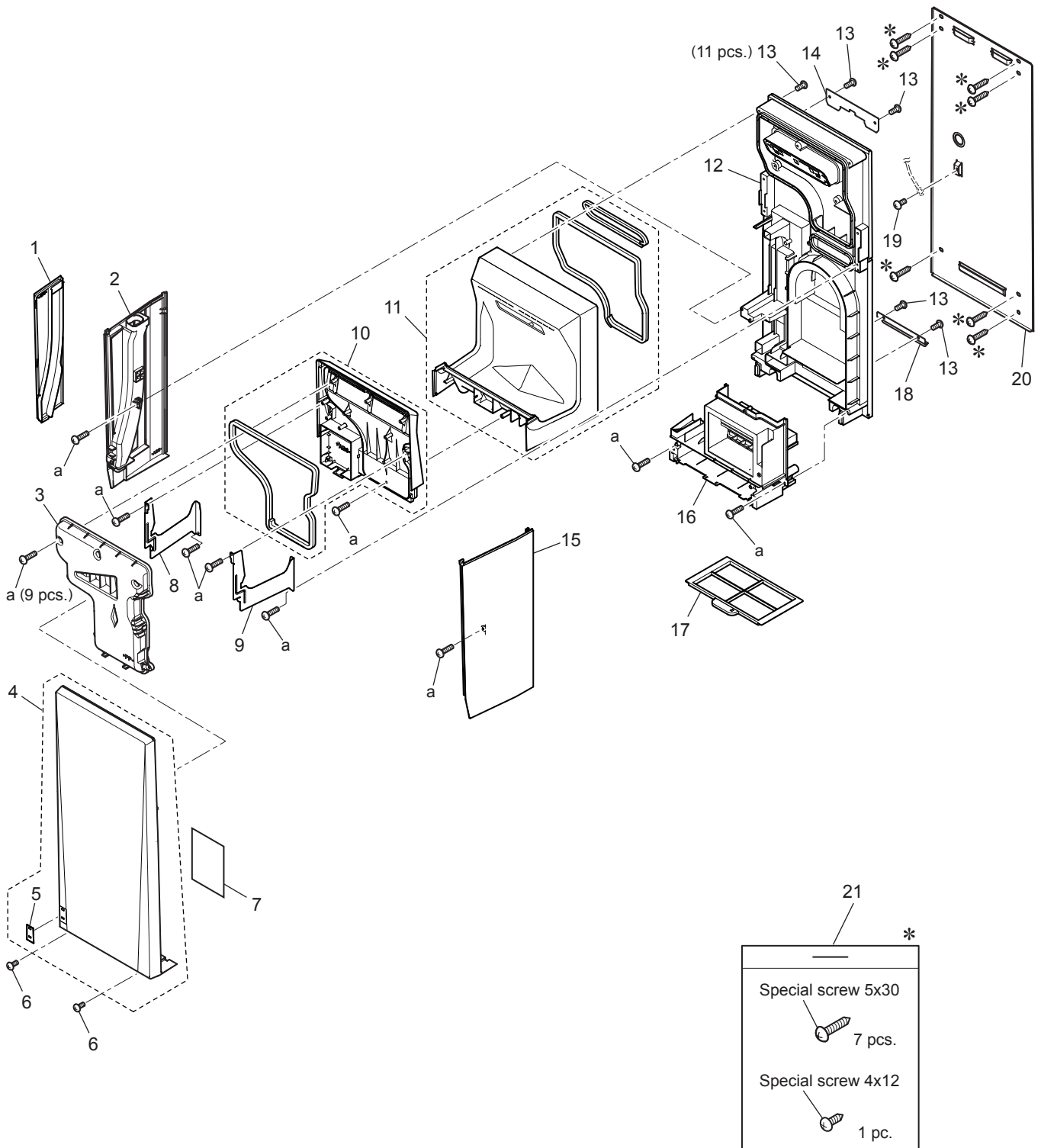

<Standard screws>

Symbol	Screw name
a	PTT screw 4x16

21 *

Special screw 5x30
 7 pcs.

Special screw 4x12
 1 pc.

* shows accessory parts.

JT-SB116JH2-S-NA

No.	Name of part	Parts No.	Q'ty pcs/unit	Critical for safety	Remarks
1	Side cover	W45 604 842	1		
2	Side panel L	W45 604 847	1		
3	Exhaust duct	W45 604 807	1		
4	Front panel	W45 604 819	1		
5	Indicator plate	W45 604 857	1		
6	Special screw 4x16	W00 000 103	2		
7	Wiring diagram	W45 604 360	1		
8	Panel holder L	W45 604 825	1		
9	Panel holder R	W45 604 826	1		
10	Panel (front)	W45 604 806	1		With packing
11	Panel (back)	W45 604 810	1		
12	Base	W45 604 814	1		
13	Special screw 4x16	W00 000 090	17		
14	Hook (upper)	W45 604 834	1		
15	Side panel R	W45 604 844	1		
16	Cover	W45 604 813	1		
17	Filter	W45 604 851	1	⚠	
18	Hook (lower)	W45 604 824	1		
19	PT screw 4x8 BS	W00 000 011	4		
20	Back plate	W45 604 831	1		
21	Screws in bag	W45 604 050	1		

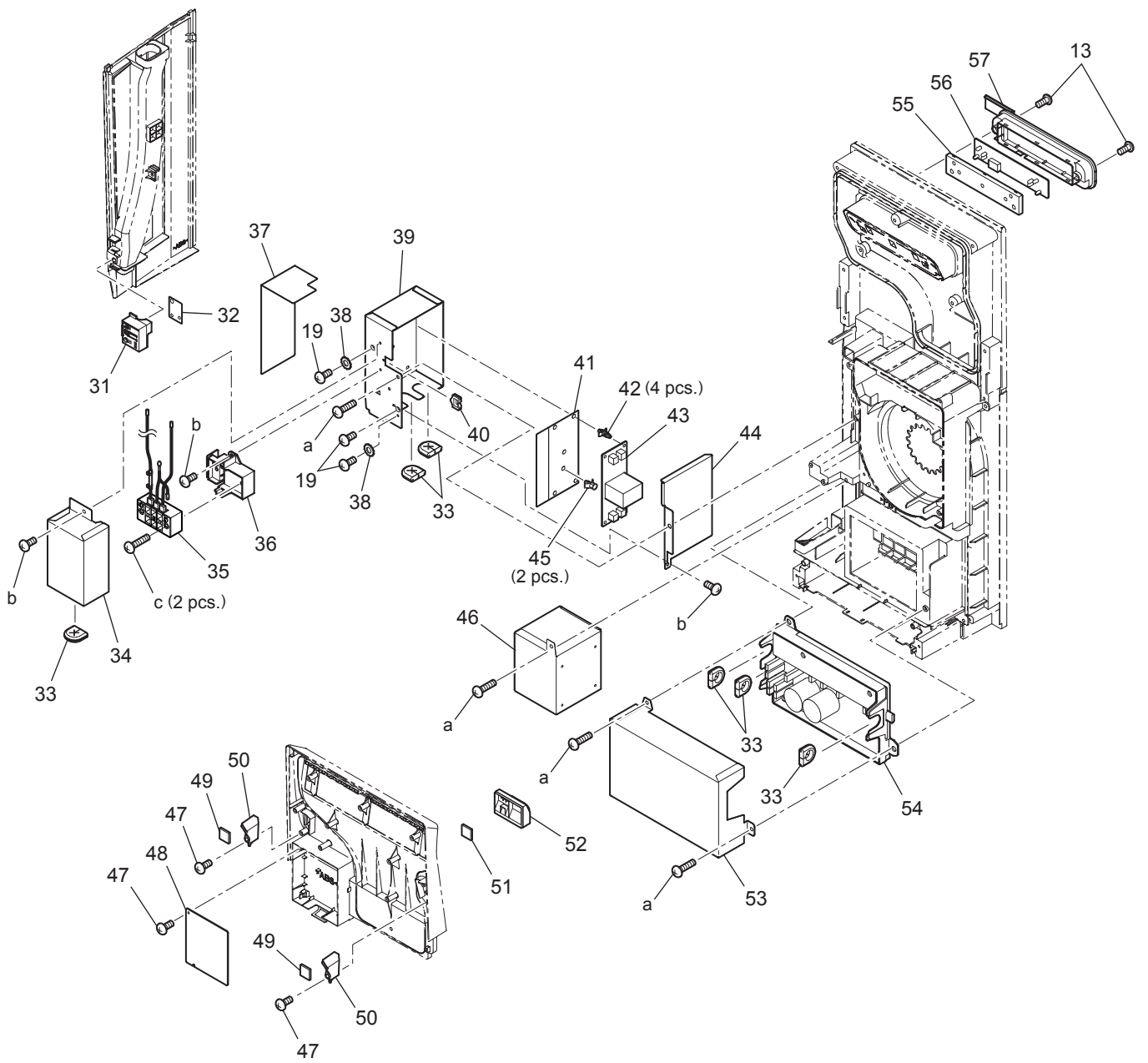

<Standard screws>

Symbol	Screw name
a	PTT screw 4x16
b	PTT screw 4x6
c	PPT screw 4x20

JT-SB116JH2-S-NA

No.	Name of part	Parts No.	Q'ty pcs/unit	Critical for safety	Remarks
31	LED holder	W45 604 850	1		
32	Circuit board	W45 604 183	1	⚠	JT-30S5R
33	Cord bush	W00 000 225	6		
34	TB cover	W45 604 827	1		
35	Terminal block	W45 604 223	1	⚠	3P · With the thermal fuse
36	TB holder	W45 603 806	1		
37	Insulator sheet	W45 604 854	1	⚠	
38	Lock washer (4)	W00 000 082	2		
39	TB fix plate	W45 604 832	1		
40	Cord bush	W00 000 273	1		
41	Insulator sheet	W45 604 853	1	⚠	
42	Spacer	W45 604 096	4		LCBS-3-19
43	Circuit board	W45 604 171	1	⚠	JT-34F
44	PCB cover	W45 604 833	1		
45	Support piece	W45 604 095	2		
46	Reactor assembly	W45 604 803	1	⚠	
47	Special screw 4x12	W00 000 088	3		
48	Circuit board	W45 604 178	1	⚠	JT-30M10
49	Circuit board	W45 604 181	2	⚠	JT-30S2R
50	Fix piece	W45 604 838	2		
51	Circuit board	W45 604 182	1	⚠	JT-30S3R
52	Sensor holder	W45 604 839	1		
53	PCB cover	W45 604 829	1		
54	Circuit board	W45 604 172	1	⚠	JT-34P1H
55	Fix plate	W45 604 840	1		
56	Circuit board	W45 604 180	1	⚠	JT-30S1R
57	Maintenance cover	W45 604 837	1		

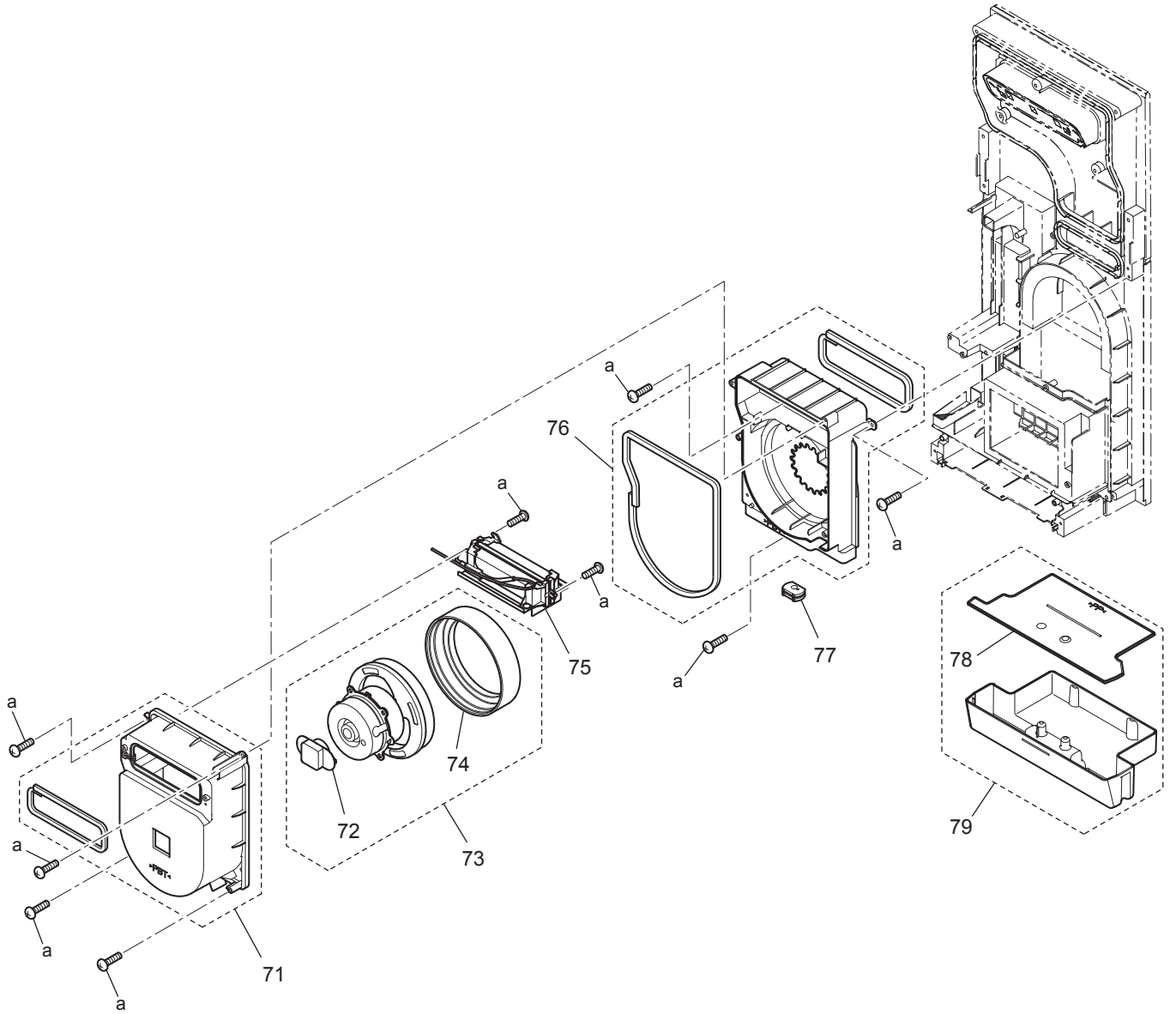

<Standard screws>

Symbol	Screw name
a	PTT screw 4x16

JT-SB116JH2-S-NA

No.	Name of part	Parts No.	Q'ty pcs/unit	Critical for safety	Remarks
71	Blower cover	W45 604 802	1		With packing
72	Blower stopper	W45 604 232	1		
73	Blower assembly	W45 604 401	1	⚠	
74	Floating rubber	W45 604 233	1		
75	Heater (PTC)	W45 604 800	1	⚠	With the fuse
76	Blower case	W45 604 845	1		With packing
77	Cord bush	W45 604 230	1		
78	Tank cover	W45 604 849	1		
79	Tank assembly	W45 604 823	1		

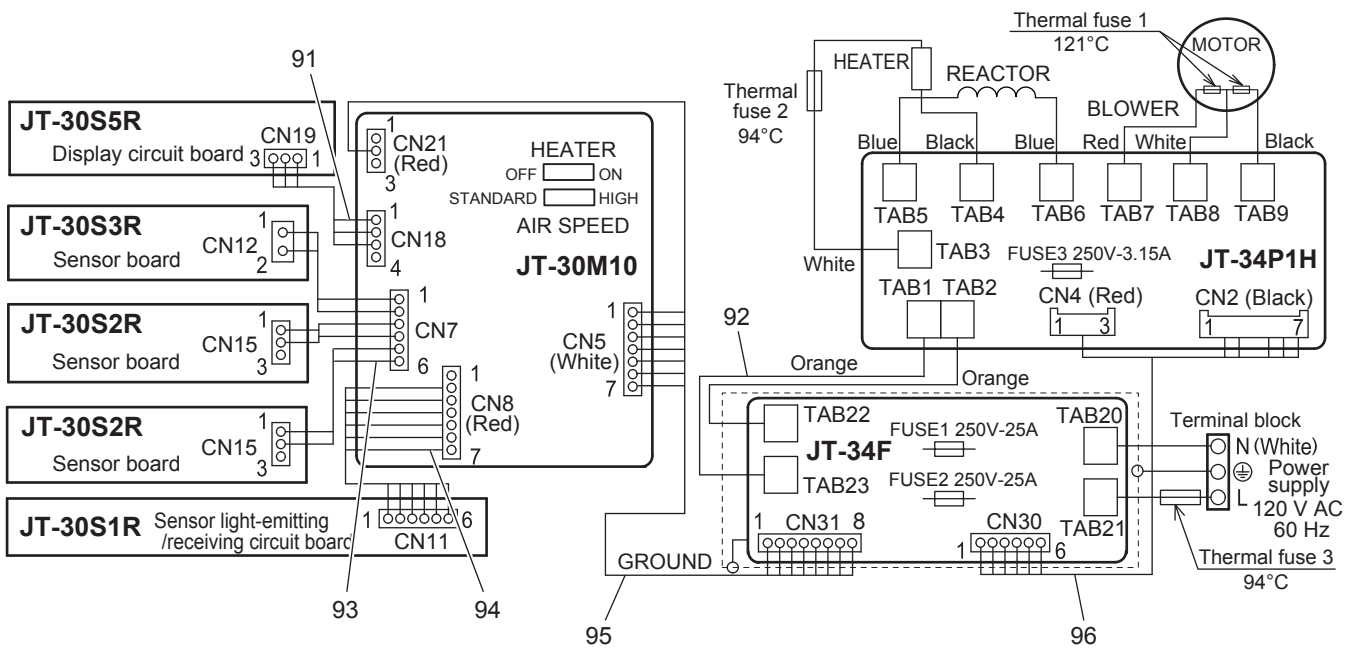

JT-SB116JH2-S-NA

No.	Name of part	Parts No.	Q'ty pcs/unit	Critical for safety	Remarks
91	Lead wire	W45 604 219	1	△	CN18-CN19
92	Lead wire	W45 604 224	1	△	TAB1·2-TAB22·23
93	Lead wire	W45 604 220	1	△	CN7-CN12·CN15
94	Lead wire	W45 604 221	1	△	CN8-CN11
95	Lead wire	W45 604 226	1	△	CN31-CN5·CN21
96	Lead wire	W45 604 225	1	△	CN30-CN2·CN4

JT-SB116JH2-W-NA

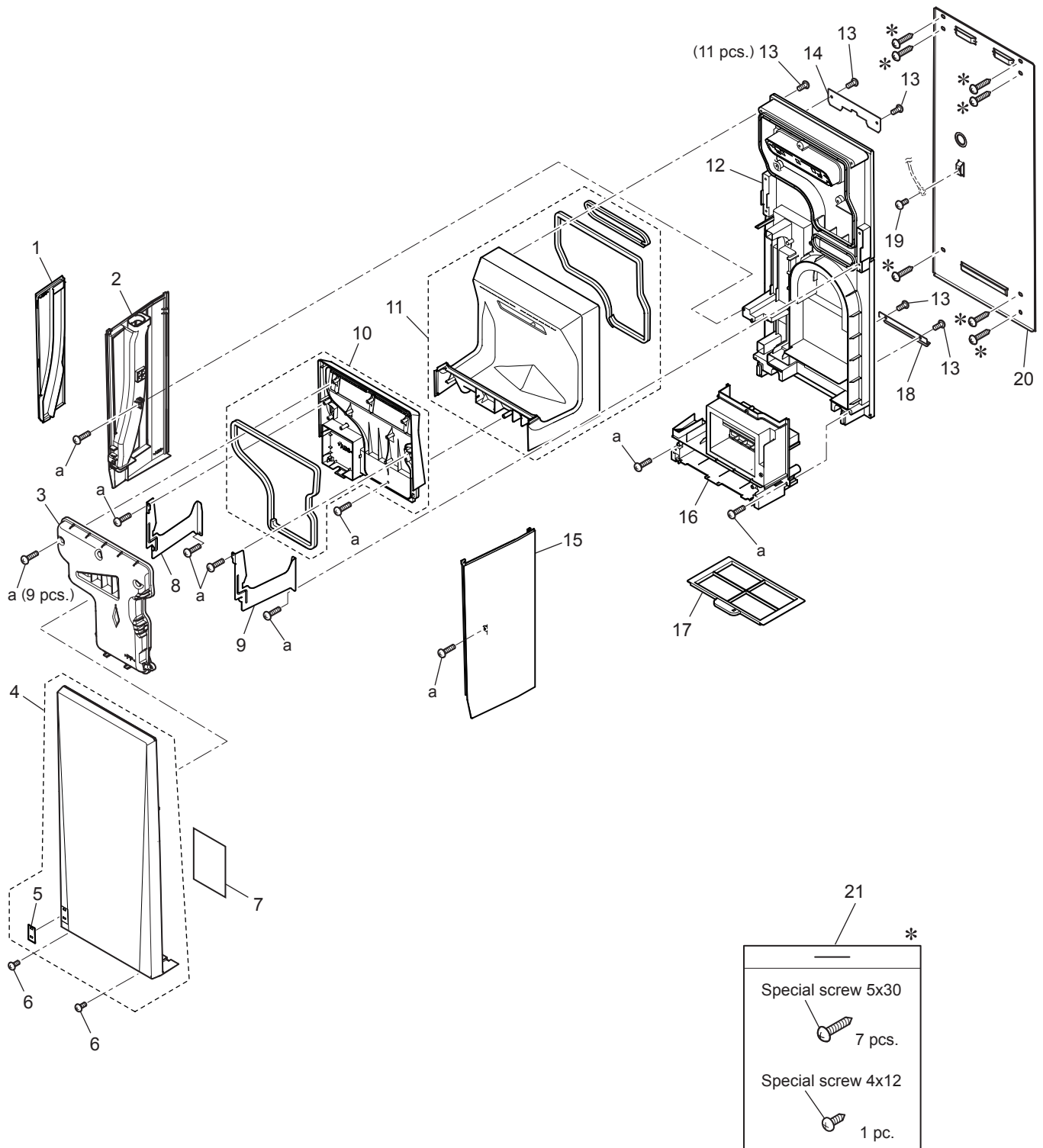

<Standard screws>

Symbol	Screw name
a	PTT screw 4x16

21 *

Special screw 5x30
7 pcs.

Special screw 4x12
1 pc.

* shows accessory parts.

JT-SB116JH2-W-NA

No.	Name of part	Parts No.	Q'ty pcs/unit	Critical for safety	Remarks
1	Side cover	W45 604 841	1		
2	Side panel L	W45 604 846	1		
3	Exhaust duct	W45 604 807	1		
4	Front panel	W45 604 817	1		
5	Indicator plate	W45 604 855	1		
6	Special screw 4x16	W00 000 103	2		
7	Wiring diagram	W45 604 360	1		
8	Panel holder L	W45 604 825	1		
9	Panel holder R	W45 604 826	1		
10	Panel (front)	W45 604 805	1		With packing
11	Panel (back)	W45 604 811	1		
12	Base	W45 604 814	1		
13	Special screw 4x16	W00 000 090	17		
14	Hook (upper)	W45 604 834	1		
15	Side panel R	W45 604 843	1		
16	Cover	W45 604 813	1		
17	Filter	W45 604 851	1	⚠	
18	Hook (lower)	W45 604 824	1		
19	PT screw 4x8 BS	W00 000 011	4		
20	Back plate	W45 604 831	1		
21	Screws in bag	W45 604 050	1		

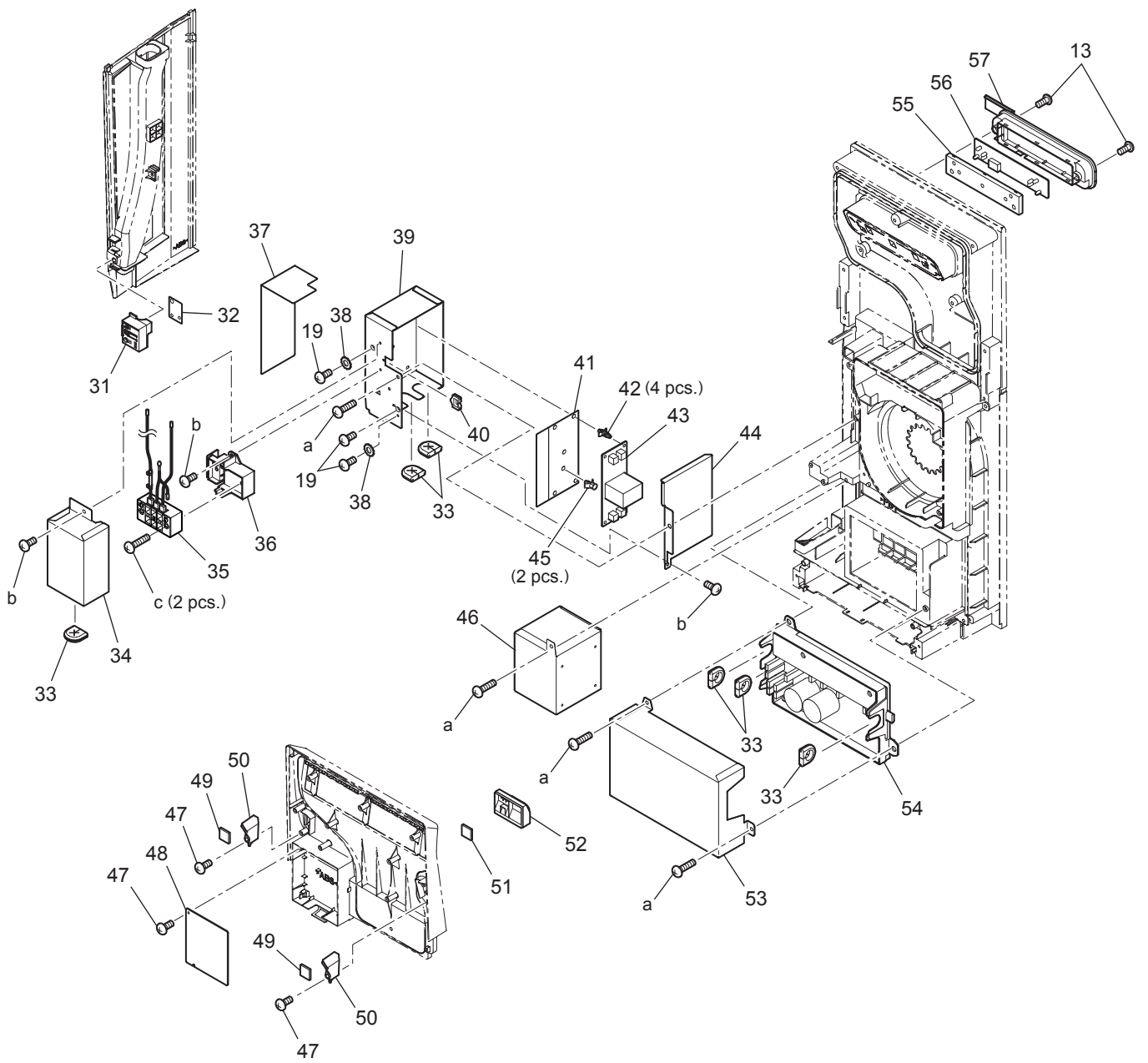

<Standard screws>

Symbol	Screw name
a	PTT screw 4x16
b	PTT screw 4x6
c	PPT screw 4x20

JT-SB116JH2-W-NA

No.	Name of part	Parts No.	Q'ty pcs/unit	Critical for safety	Remarks
31	LED holder	W45 604 850	1		
32	Circuit board	W45 604 183	1	⚠	JT-30S5R
33	Cord bush	W00 000 225	6		
34	TB cover	W45 604 827	1		
35	Terminal block	W45 604 223	1	⚠	3P · With the thermal fuse
36	TB holder	W45 603 806	1		
37	Insulator sheet	W45 604 854	1	⚠	
38	Lock washer (4)	W00 000 082	2		
39	TB fix plate	W45 604 832	1		
40	Cord bush	W00 000 273	1		
41	Insulator sheet	W45 604 853	1	⚠	
42	Spacer	W45 604 096	4		LCBS-3-19
43	Circuit board	W45 604 171	1	⚠	JT-34F
44	PCB cover	W45 604 833	1		
45	Support piece	W45 604 095	2		PCB-3S
46	Reactor assembly	W45 604 803	1	⚠	
47	Special screw 4x12	W00 000 088	3		
48	Circuit board	W45 604 179	1	⚠	JT-30M10A
49	Circuit board	W45 604 181	2	⚠	JT-30S2R
50	Fix piece	W45 604 838	2		
51	Circuit board	W45 604 182	1	⚠	JT-30S3R
52	Sensor holder	W45 604 839	1		
53	PCB cover	W45 604 829	1		
54	Circuit board	W45 604 172	1	⚠	JT-34P1H
55	Fix plate	W45 604 840	1		
56	Circuit board	W45 604 180	1	⚠	JT-30S1R
57	Maintenance cover	W45 604 837	1		

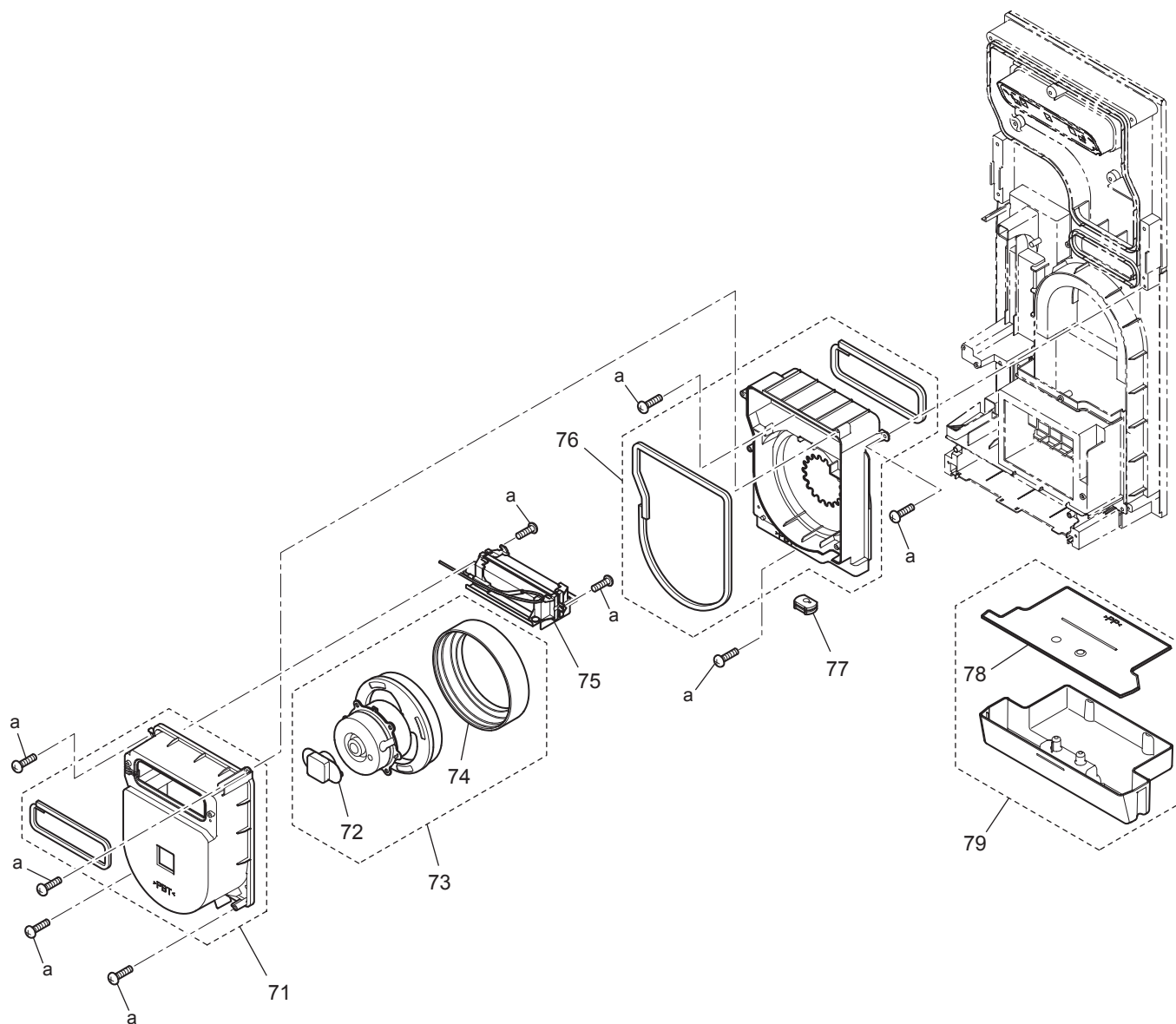

<Standard screws>

Symbol	Screw name
a	PTT screw 4x16

JT-SB116JH2-W-NA

No.	Name of part	Parts No.	Q'ty pcs/unit	Critical for safety	Remarks
71	Blower cover	W45 604 802	1		With packing
72	Blower stopper	W45 604 232	1		
73	Blower assembly	W45 604 401	1	⚠	
74	Floating rubber	W45 604 233	1		
75	Heater (PTC)	W45 604 800	1	⚠	With the fuse
76	Blower case	W45 604 845	1		With packing
77	Cord bush	W45 604 230	1		
78	Tank cover	W45 604 849	1		
79	Tank assembly	W45 604 822	1		

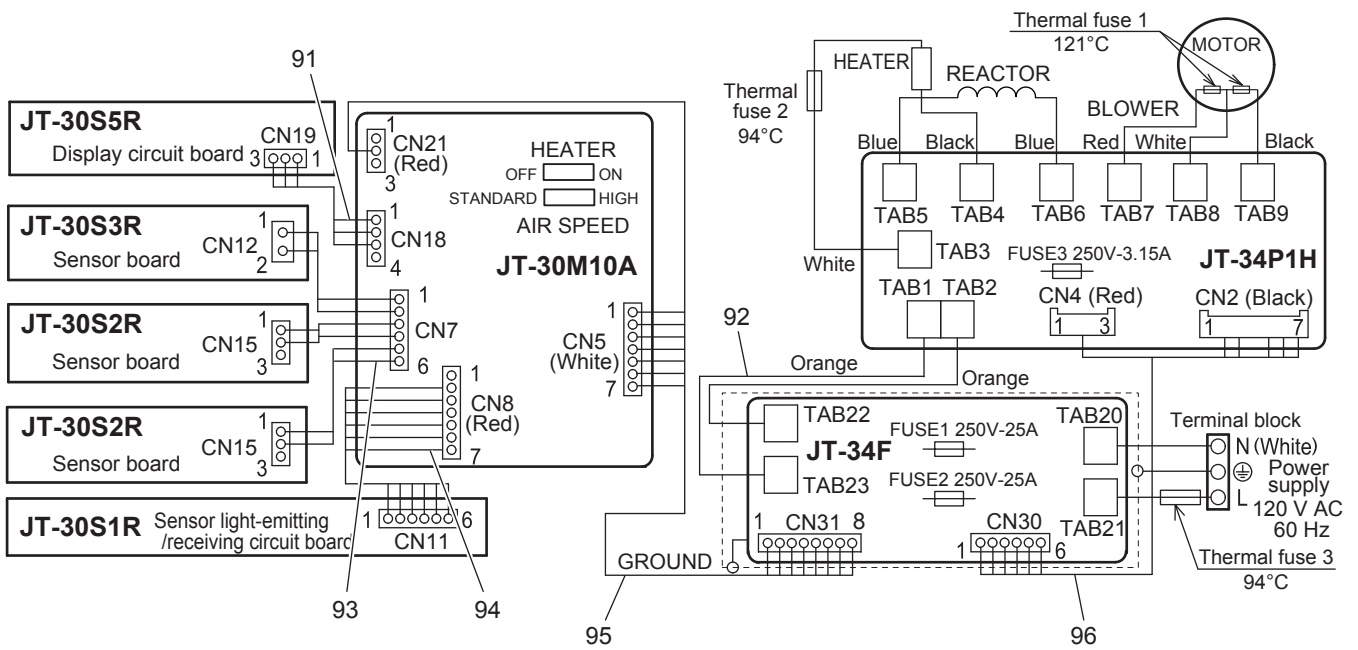

JT-SB116JH2-W-NA

No.	Name of part	Parts No.	Q'ty pcs/unit	Critical for safety	Remarks
91	Lead wire	W45 604 219	1	△	CN18-CN19
92	Lead wire	W45 604 224	1	△	TAB1·2-TAB22·23
93	Lead wire	W45 604 220	1	△	CN7-CN12·CN15
94	Lead wire	W45 604 221	1	△	CN8-CN11
95	Lead wire	W45 604 226	1	△	CN31-CN5·CN21
96	Lead wire	W45 604 225	1	△	CN30-CN2·CN4