

Job Name:

Schedule Reference:

Date:

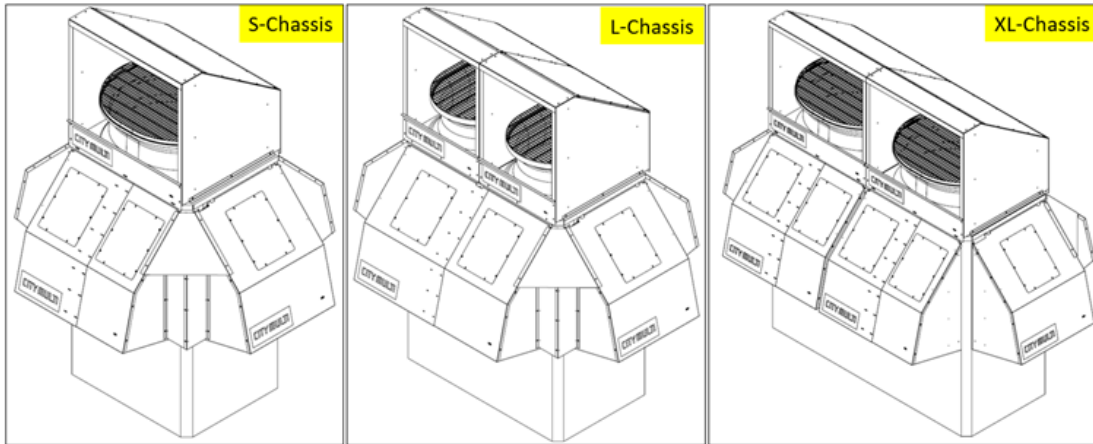

NOTES:

- Outdoor unit must be mounted at least 18" off the ground or 12" above the highest average snow fall level, whichever is greater.
- Clearances for the sides and back of the outdoor unit must be at least 17.5" more than standard installation guidelines.
- For best coil protection, two and three module units must be mounted with a minimum of 1-3/16" space between each.

Model Number	Description	Ship Weight	Carton Dimensions
CM-SD-SG	Snowguard Side (1 per box)	12.70kg (28 Lbs.)	27"W x 7"H x 37-1/2"L
CM-FRE-SG-1	Snowguard Front / Rear (S + XL) (1 per box)	13.61kg (30 Lbs.)	20"W x 7"H x 37-1/2"L
CM-FRE-SG-2	Snowguard Front / Rear (L) (1 per box)	23.59kg (52 Lbs.)	27"W x 7"H x 37-1/2"L
CM-HD-1	Snow Hood (S +XL) (1 per box)	27.21kg (60 Lbs.)	31-5/8"W x 6"H x 34-5/8"L
CM-HD-2	Snow Hood (L) (1 per box)	22.67kg (50 Lbs.)	31-5/8"W x 6"H x 34-5/8"L

COMPONENTS REQUIRED PER OUTDOOR UNIT

For models with two or three units, selections are based on a space of 1-3/16" between the modules.
 For additional space between the modules, additional components may be required.

Chart below provides a reference to the model sizes for ordering the necessary snow/wind guards and hoods for your units.

S. No.	Model No	Size	New Snow/Wind Guards & Hoods - TNU Series				
			CM-FRE-SG-1	CM-FRE-SG-2	CM-SD-SG	CM-HD-1	CM-HD-2
			1PC/BOX	1PC/BOX	1PC/BOX	1PC/BOX	1PC/BOX
			Front & Rear	Front & Rear	Side	Top (Hood)	Top (Hood)
1	PUHY-HP72TNU	L	-	2	2	-	2
2	PUHY-HP96TNU	L	-	2	2	-	2
3	PUHY-HP120TNU	L	-	2	2	-	2
4	PUHY-(E)P72TNU-A	S	2	-	2	1	-
5	PUHY-(E)P96TNU-A	L	-	2	2	-	2
6	PUHY-(E)P120TNU-A	L	-	2	2	-	2
7	PUHY-(E)P144TNU-A	L	-	2	2	-	2
8	PUHY-(E)P168TNU-A	XL	4	-	2	2	-
9	PUHY-(E)P192TNU-A	XL	4	-	2	2	-
10	PURY-(E)P72TNU-A	S	2	-	2	1	-
11	PURY-(E)P96TNU-A	L	-	2	2	-	2
12	PURY-(E)P120TNU-A	L	-	2	2	-	2
13	PURY-(E)P144TNU-A	L	-	2	2	-	2
14	PURY-(E)P168TNU-A	XL	4	-	2	2	-
15	PURY-HP72TNU	L	-	2	2	-	2
16	PURY-HP96TNU	L	-	2	2	-	2
17	PURY-HP120TNU	L	-	2	2	-	2

Note: Mitsubishi Electric (MESCA) supports the use of only MESCA supplied and approved Snow Guard / Wind Deflectors / Windscreens and accessories for proper functioning of the unit(s). Use of non-MESCA supported Snow Guard / Wind Deflectors / Windscreens and accessories will affect warranty coverage.

Specifications are subject to change without notice.

* All electrical work shall comply with National (CEC) and local codes and regulations. Should this document be altered or changed without MESCA's permission, it becomes null and void. MESCA assumes no responsibility for any consequences in such cases.

Snow/Wind Guard - Snow Hood - DIMENSIONS

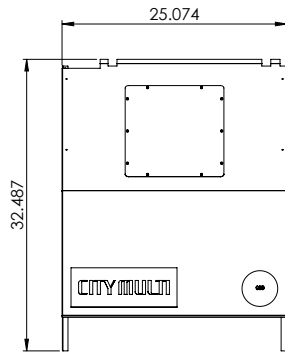

CM-SG-SG

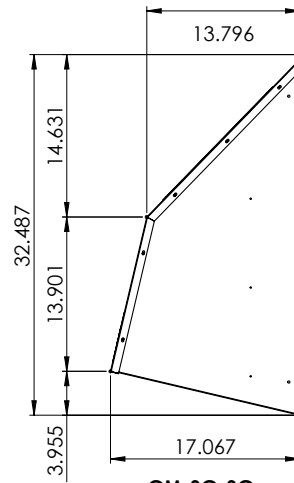

CM-SG-SG

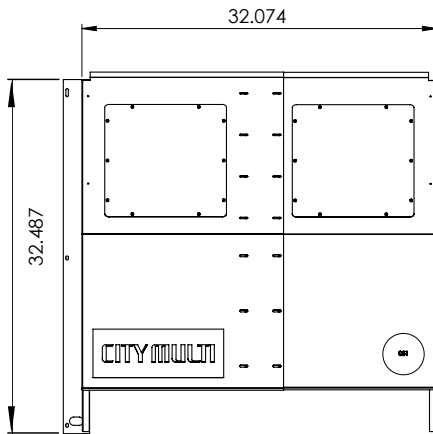

CM-FRE-SG-1

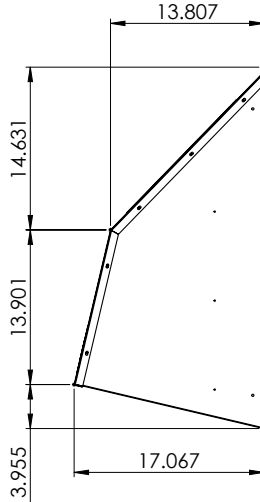

CM-FRE-SG-1
CM-FRE-SG-2

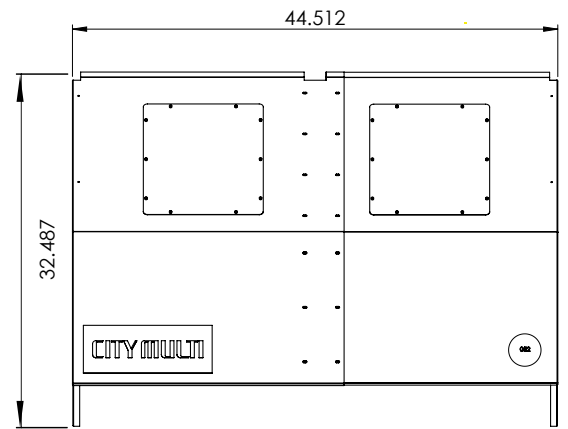

CM-FRE-SG-2

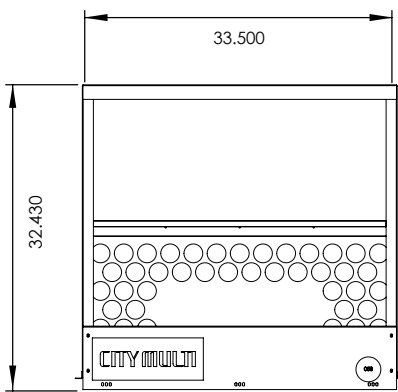

CM-HD-1

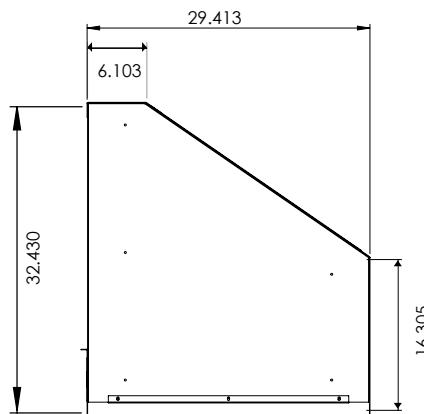

CM-HD-1
CM-HD-2

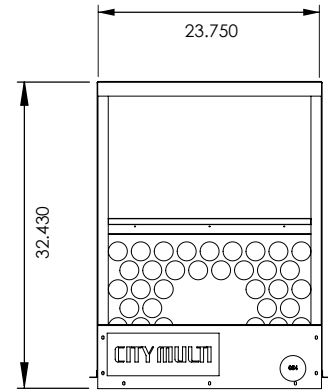

CM-HD-2

Should this document be altered or changed without MESCO's permission, it becomes null and void. MESCO assumes no responsibility for any consequences in such cases.