

Submission Data: MSZ-FS09NA-U1

9,000 BTU/H Wall-Mounted Indoor Unit For MXZ Multi-Zone Heat Pump System

Job Name:	Location:
Purchaser:	Submitted By:
Submitted To:	Reference: Approval: Construction:
Engineer:	Date: Application:



Images provided for reference purposes only

- Wireless Handheld Remote Control
- 3D i-See Sensor
- Dual Barrier Coating
- Double Vanes
- Triple Filter System
- CN24 Auxiliary Heat Control

Rated Capacity:

Cooling ¹	Btu/h	9,000
Heat at 47°F ²	Btu/h	9,600

Indoor Unit Specifications:

Power Supply		208/230V, 1Ph, 60Hz
MCA	A	1.00
Blower Motor Full Load Amperage	A	0.65
Blower Motor Output	W	40
Airflow Rate at Cooling, Dry	CFM	137 -167 - 221 - 304 - 381
Airflow Rate at Cooling, Wet	CFM	117 - 143 - 190 - 261 - 328
Airflow Rate at Heating, Dry	CFM	140 - 167 - 225 - 381 - 437
Sound Pressure Level (Cooling)	dB(A)	20 - 23 - 29 - 36 - 40
Sound Pressure Level (Heating)	dB(A)	20 - 24 - 29 - 39 - 42
Drain Pipe Size	In. (mm)	5/8 (15.88)
External Finish Color		White (Munsell 1.0Y 9.2/0.2)
Unit Dimensions	W: In. (mm)	36-7/16 (925)
	D: In. (mm)	9-3/16 (234)
	H: In. (mm)	12(+11/16) (305(+17))
Unit Weight	Lbs. (kg)	29 (13.5)
Gas Pipe Size O.D. (Flared)	In. (mm)	3/8 (9.52)
Liquid Pipe Size O.D. (Flared)	In. (mm)	1/4 (6.35)
Moisture Removal	pints/h	0.6

Model No. Description: (Optional Controls)

MELCO-RETAIL-MINI	Building Automated System DDC Interface
PAC-US444CN-1	Simple thermostat Interface
PAR-40MAAU	Wired Wall Mounted Remote Control
PAR-CT01MAU-SB	Touch Screen Wired Wall Mounted Control
PAC-YT53CRAU-J	Basic Wired Wall Mounted Control
MAC-1710RA-U	External Heat Control Adapter
PAM-4	Heater control relay
RMF-CA200-V1	Deluxe Thermostat Interface
MAC-334IF-E	System Control Interface
MAC-497	PAR Control Interface

Model No. Description: (Optional Accessories)

M21EAA307	Wired Remote Sensor
MAC-2330FT	Anti-Allergy Enzyme Filter (Electro static)
MAC-3080FT	Platinum Deodorizing Filter
CN24RELAYKITCM3	CN24 Relay Kit

AHRI Rated Conditions (Rated data is determined at a fixed compressor speed)

¹Cooling (Indoor // Outdoor) 80°F (26.6°C) DB, 67°F (19.4°C) WB // 95°F (35°C) DB, 75°F (23.9°C) WB

²Heating at 47°F (8.3°C) (Indoor // Outdoor) 70°F (21.1°C) DB, 60°F (15.6°C) WB // 47°F (8.3°C) DB, 43°F (6.1°C) WB

For data on specific indoor units (all ducted, all non-ducted, and both ducted and non-ducted) combinations, see MXZ Technical and Service Manuals.

Applications should be restricted to comfort cooling only; equipment cooling applications are not recommended for low ambient temperature conditions.

Note:

1. Mitsubishi Electric Sales Canada Inc. (MESCA) supports the use of only MESCA supplied and approved components and accessories for proper functioning of the unit(s). Use of non - MESCA supported components and accessories will affect warranty coverage. MESCA recommends (A) consideration of all applicable design and application parameters and requirements specific to any project.

2. Should any person change this document in any manner whatsoever without MESCA's written permission, the document shall be of no force and effect and any change shall be deemed to be a representation and warranty made by that person and not MESCA. That person, and not MESCA, shall assume full responsibility for the consequences of such changes. MESCA assumes no responsibility for any consequences in such cases.

Indoor Unit Outline and Dimensions:

Unit: inch

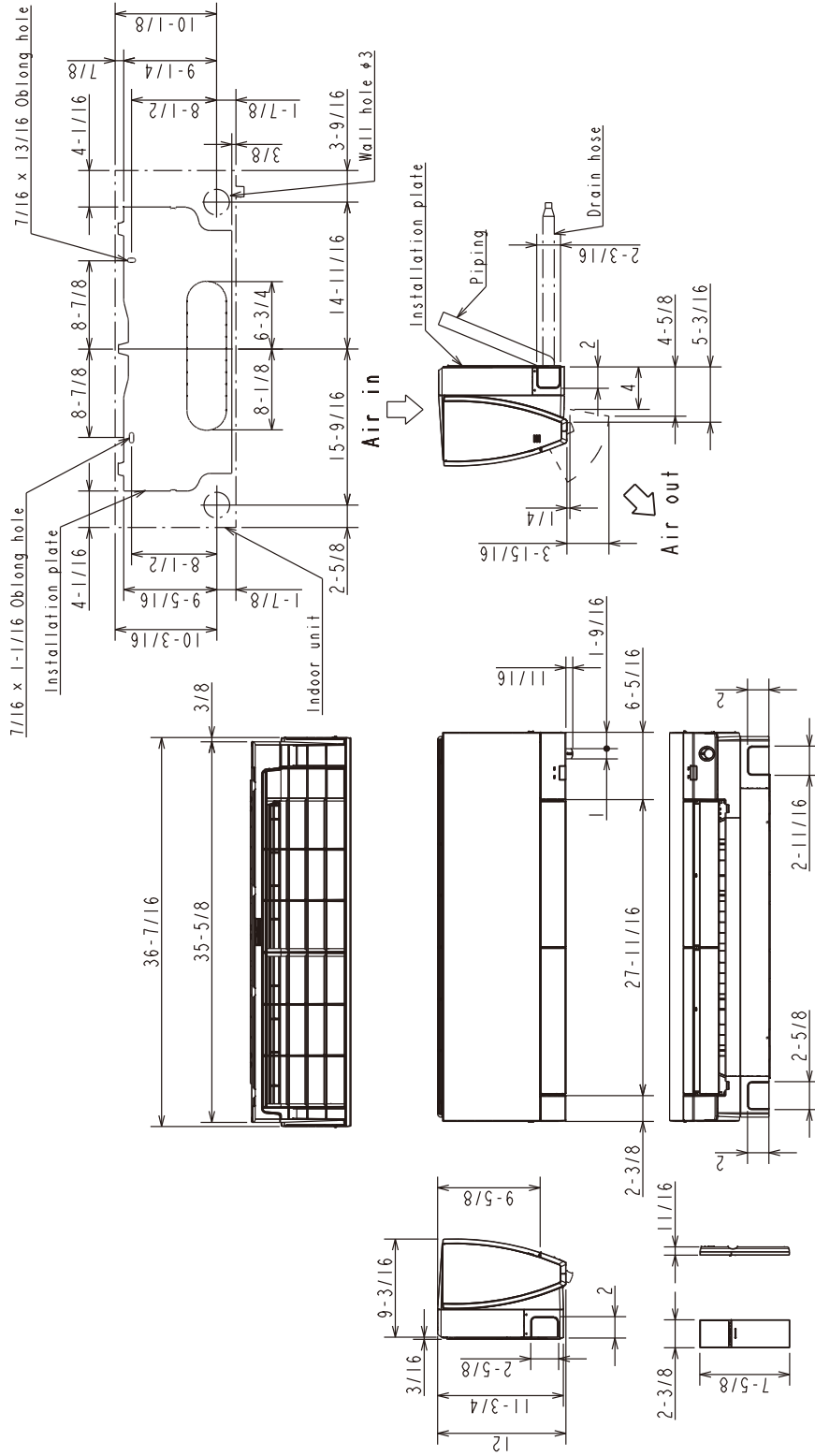

(MSZ-FS15/18NA)

Insulation	φ1-7/16 O.D
Liquid line	φ1/4 19-11/16 (Flared connection φ1/4)
Gas line	φ3/8 16-15/16 (Flared connection φ1/2)
Drain hose	Insulation φ1-1/8 Connected part φ5/8 O.D

(MSZ-FS06/09/12NA)

Insulation	φ1-7/16 O.D
Liquid line	φ1/4 19-11/16 (Flared connection φ1/4)
Gas line	φ3/8 16-15/16 (Flared connection φ3/8)
Drain hose	Insulation φ1-1/8 Connected part φ5/8 O.D

