

**SUBMITTAL DATA: PCA-A42KA8 & PUZ-A42NKA7**  
42,000 BTU/H CEILING-SUSPENDED HEAT PUMP SYSTEM

Job Name:	Engineer:
Purchaser:	Application:
Submitted To:	For: <input type="checkbox"/> Reference <input type="checkbox"/> Approval <input type="checkbox"/> Construction
Submitted By:	Location:
System Designation:	Schedule No.:



**UNIT OPTION:**

Standard Model.....PUZ-A42NKA7

**ACCESSORIES:**

- i-See Sensor (PAC-SH91MK-E)
- Remote Controller Kit with i-See Sensor (PAR-SA92MW-E)
- Drain Pump (PAC-SH84DM-E)
- External Heater Adaptor (PAC-SE56RA-E)

**Controls**

- Wireless Controller (MHK2)
- Advanced Wired Controller (PAR-41MAAU)
- Simple Wired Controller (PAC-YT53CRAU)
- Interface Module (RMF-CA200)
- M-NET Adapter (PAC-SJ95MA-E)

**Outdoor Unit**

- Rear Snow Guard (SG-1-RE)
- Side Snow Guard (SG-1-SD)
- Front Wind Deflector (x2 required) (CM-S-FR-NKMU)
- Front Wind Blocker (x2 per box) (CM-S-BLK-NKMU)

**Note: Mitsubishi Electric (MESCA) supports the use of only MESCA supplied and approved Snow Guard / Wind Deflectors / Windscreens and accessories for proper functioning of the unit(s). Use of non-MESCA supported Snow Guard / Wind Deflectors / Windscreens and accessories will affect warranty coverage.**

**SPECIFICATIONS:**

Rated Conditions (Capacity / Input)*		
Cooling	Btu/h / W	42,000 / 4,110
Heating at 47° F	Btu/h / W	45,000 / 3,480
Heating at 17° F	Btu/h / W	31,800 / 3,160

\* Rating Conditions per AHRI Standard:  
Cooling | Indoor: 80° F (27° C)DB / 67° F (19° C)WB; Outdoor: 95° F (35° C)DB / 75° F (24° C)WB  
Heating at 47° F | Indoor: 70° F (21° C)DB / 60° F (16° C)WB; Outdoor: 47° F (8° C)DB / 43° F (6° C)WB  
Heating at 17° F | Indoor: 70° F (21° C)DB / 60° F (16° C)WB; Outdoor: 17° F (-8° C)DB / 15° F (-9° C)WB

Capacity Range		
Cooling	Btu/h	16,000 - 42,000
Heating at 47° F	Btu/h	18,100 - 48,000

Operating Range	
Cooling	0°F** (-18°C) to 115°F (46°C) DB
Heating	-4°F (-20°C) to 70°F (21°C) DB

\*\* Windscreens required for cooling operation below 23°F (-5°C)

AHRI Efficiency Rating	
EER2	10.0
SEER2	17.7
HSPF2 (IV) / (V)	9.4 / 7.8
COP at 47° F	3.78
COP at 17° F	2.94

<b>Electrical Power Requirements</b>	208 / 230V, 1-Phase, 60 Hz
--------------------------------------	----------------------------

Minimum Circuit Ampacity (MCA) *	Breaker Size	MOCP (Outdoor)
Indoor 2 AMP	Outdoor 25 AMP	30 AMP
		31 AMP

\* All electrical work shall comply with National (CEC) and local codes and regulations.

Indoor Unit		
Fan Motor (ECM)	F.L.A.	0.97
Fan Motor Output	W	160
SHF / Moisture Removal		0.69 / 11.7 pt./h
Field Drainpipe Size O.D	in. (mm)	1-1/32 (26)

Outdoor Unit		
Compressor		DC INVERTER-driven Twin Rotary
Fan Motor (ECM)	F.L.A.	0.5+0.5
Fan Motor Power	W	74

Airflow Rate (Low-M1-M2-Hi)			
Indoor (Cooling)	DRY	CFM	810-885-955-1,025
	WET		740-810-885-955
Outdoor	DRY		3,880

Sound Pressure Level			
Indoor (Low-M1-M2-Hi)	Cooling	dB(A)	39-41-43-45
			52
			53
Outdoor	Heating		

External Dimensions		
Indoor (H x W x D)	In.(mm)	9-1/16 x 63 x 26-3/4 (230 x 1,600 x 680)
Outdoor (H x W x D)		52-11/16 x 41-5/16 x 13 + 1-3/16 (1,338 x 1050 x 330 + 30)

Net Weight		
Indoor	Lbs.(kg)	86 (39)
Outdoor		214 (97)

External Finish	
Indoor	White Munsel No. 6.4Y 8.9/0.4
Outdoor	Ivory Munsell No. 3Y 7.8 / 1.1

<b>Refrigerant</b>	R410A ; 10lbs. 6oz. (4.7kg)
--------------------	-----------------------------

Refrigerant Piping (Flared)		
Liquid (High Pressure)	In.(mm)	3/8 (9.52)
Gas (Low Pressure)		5/8 (15.88)
Maximum Total Refrigerant Pipe Length	Fl. (m)	165 (50)
Maximum Vertical Separation	Fl. (m)	100 (30)

Should this document be altered or changed without MESCA's permission, it becomes null and void. MESCA assumes no responsibility for any consequences in such cases.

# DIMENSIONS: PCA-A42KA8

Unit: in. (mm)

**NOTES.**

1. Use M10 or W3/8 screw for anchor bolt.
2. Please be sure when installing the drain pump (option parts), refrigerant pipe will be only upward.

**[FRONT VIEW]**

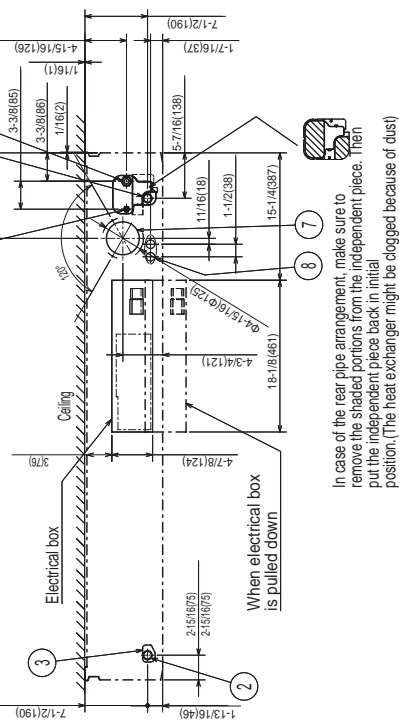

In case of the rear pipe arrangement, make sure to remove the shaded portions from the independent piece. If not put the independent piece back in initial position. (The heat exchanger might be clogged because of dust)

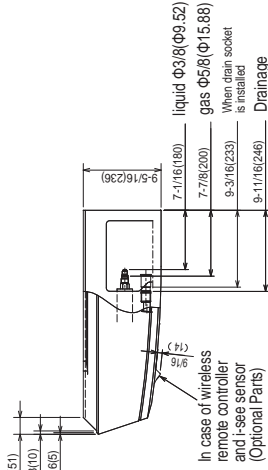
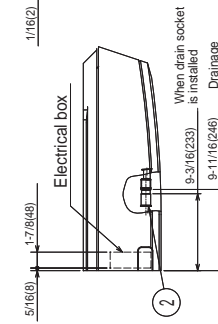
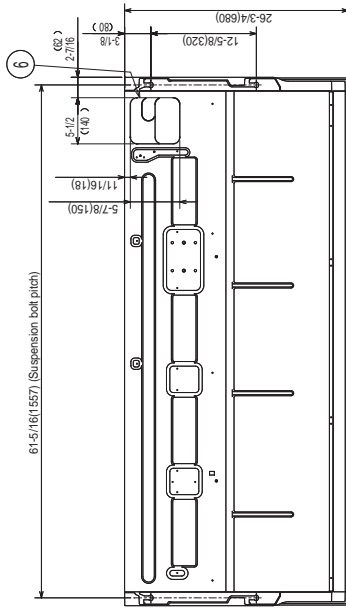

- 1 Drainage pipe connection(1(26mm))I.D.)
- 2 Drainage pipe connection(for the left arrangement)
- 3 Knockout hole for left drain-piping arrangement
- 4 Refrigerant-pipe connection (gas pipe side/flared connection)
- 5 Refrigerant-pipe connection (liquid pipe side/flared connection)
- 6 Knockout hole for upper drain pipe arrangement
- 7 Knockout hole for fresh air intake Φ3-15/16(Φ100)
- 8 Knockout hole for wiring arrangement Φ7/8(Φ22) Accessory...Drain socket (1(26mm))I.D.)

**In case of wireless remote controller and I-see sensor(Optional Parts)**

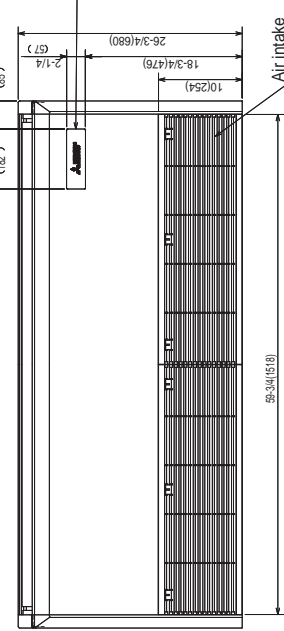
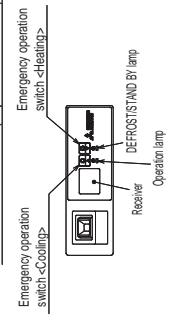

# DIMENSIONS: PUZ-A42NKA7

Unit: mm (in.)

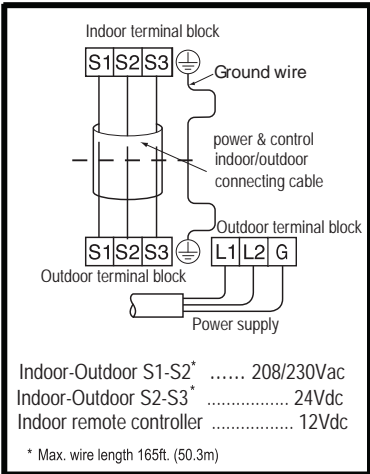
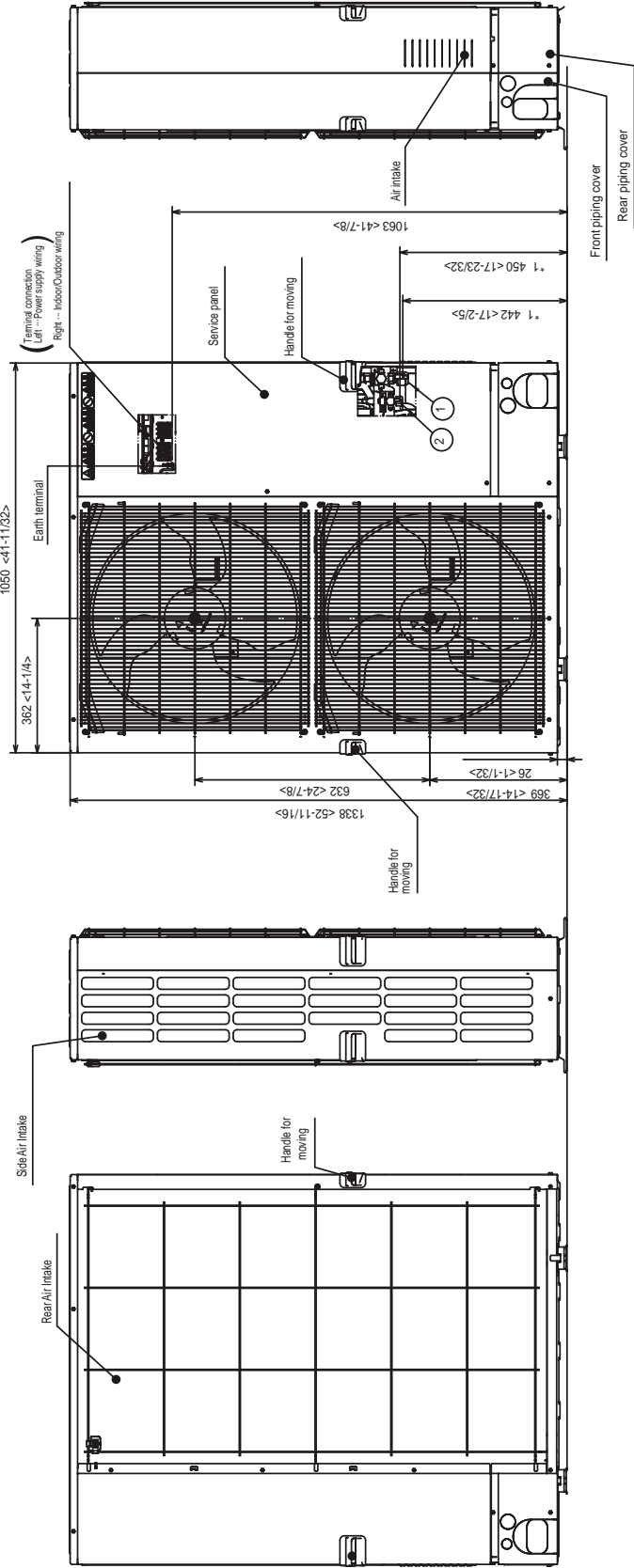
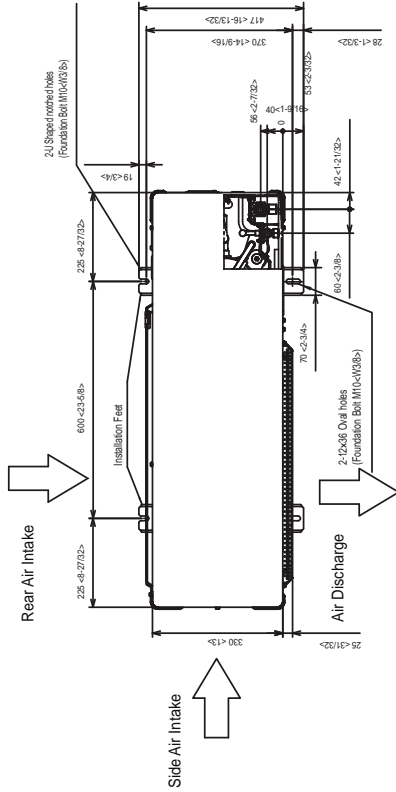

### Example of Notes

- ① ... Refrigerant GAS pipe connection (FLARE) ø15.88(5/8F)
- ② ... Refrigerant LIQUID pipe connection (FLARE) ø9.52(3/8F)
- \* ... Indication of STOP VALVE connection location.

Should this document be altered or changed without MESCA's permission, it becomes null and void. MESCA assumes no responsibility for any consequences in such cases.

