

Job Name:

Schedule Reference:

Date:



MODULAR WATER-SOURCE VRF HEAT PUMP WITH HEAT RECOVERY SYSTEM

Standard Installation (*1) PQRY-P240ZSLMU-A1
Geothermal Installation (*1)(*2)(*3) PQRY-P240ZSLMU-A1

ACCESSORIES

Heat Source Twinning kit.....	CMY-Q100CBK2
BC Controller Main	CMB-P108,1012,1016NU-JA1, CMB-P1016NU-KA1
BC Controller Sub	CMB-P104,108NU-KB1
Joint Adapter (Port Connector > 54,000 Btu/h).....	CMY-R160-J1
Branch Joint (Downstream capacity ≤72,000 Btu/h).....	CMY-Y102SS-G2
Branch Joint (Downstream capacity 73,000-96,000 Btu/h).....	CMY-Y102LS-G2
T-Branch Joint (145,000 - 234,000 Btu/h)	CMY-Y202S-G2
T-Branch Joint (≥ 235,000 Btu/h).....	CMY-Y302S-G2
Branch Joint (Downstream capacity ≤126,000 Btu/h)	CMY-R201S-G
Branch Joint (Downstream capacity 127,000-216,000 Btu/h).....	CMY-R202S-G
Branch Joint (Downstream capacity 217,000-234,000 Btu/h).....	CMY-R203S-G
Branch Joint (Downstream capacity 235,000-360,000 Btu/h).....	CMY-R204S-G
Reducer (Between ODU and BC).....	CMY-R302S-G1
Reducer (Between Main and Sub BC).....	CMY-R303S-G1
Reducer (Between Main and Sub BC).....	CMY-R304S-G1
Reducer (Between Main and Sub BC).....	CMY-R305S-G1
Reducer (Between Main and Sub BC).....	CMY-R306S-G

Specifications		System	Module 1	Module 2
Unit Type		PQRY-P240ZSLMU-A1	PQRY-P120ZLMU-A1	PQRY-P120ZLMU-A1
Nominal Cooling Capacity (575V) (*1)	Btu/h	240,000	120,000	120,000
Nominal Heating Capacity (575V) (*1)(*2)(*3)	Btu/h	270,000	135,000	135,000
Operating Temperature Range	Cooling (Indoor)	Refer to Module Data	59~75° F (15~24° C) WB	
	Heating (Indoor)		59~81° F (15~27° C) DB	
Operating Water Temperature Range	Cooling (*4)	Refer to Module Data	50~113° F (10~45° C)	
	Heating (*4)		50~113° F (10~45° C)	
External Dimensions (H x W x D)	In. (mm)	Refer to Module Data	43-5/16 x 34-11/16 x 21-11/16 (1100 x 880 x 550)	43-5/16 x 34-11/16 x 21-11/16 (1110 x 880 x 550)
Net Weight	Lbs. (kg)	816 (370)	408 (185)	408 (185)
External Finish		Refer to Module Data	Galvanized steel sheet	
Electrical Power Requirements	Voltage, Phase, Hertz	Refer to Module Data (*5)	575V, 3-phase, 60Hz	
Minimum Circuit Ampacity (MCA) (*5) (*)	A	Refer to Module Data (*5)	11	11
Maximum Overcurrent Protection (MOP) (*5)	A	Refer to Module Data (*5)	15	15
<i>Circulating Water (quality must meet regulations)</i>				
Flow Rate	GPM	Refer to Module Data	25.4	25.4
Pressure Drop	psi		3.48	3.48
Operation Volume Range	GPM		13.2 - 31.7	13.2 - 31.7
Maximum Water Pressure	psi		290	290
Water-source Connection for Inlet and Outlet	In.		NPT1-1/2 Screw (Install strainer (more than 50 meshes) at water inlet piping of the unit)	
<i>Piping Diameter (Brazed)</i>				
From Twinning Kit to First Joint or Header (In. / mm)	Liquid (High Pressure)	7/8 / 22.2 (*7)	Refer to System Data	Refer to System Data
	Gas (Low Pressure)	1-3/8 / 34.93	Refer to System Data	Refer to System Data
From Modules to Twinning Kit (In. / mm)	Liquid (High Pressure)	Refer to Module Data	3/4 / 19.05	3/4 / 19.05
	Gas (Low Pressure)	Refer to Module Data	-	7/8 / 22.2
Max. Total Refrigerant Line Length	Ft.	2,460	Refer to System Data	Refer to System Data
Max. Refrigerant Line Length (Bet.ODU & IDU)	Ft.	541		
Max. Control Wiring Length	Ft.	1,640		
Indoor Unit	Total Capacity	50~150%	Refer to System Data	Refer to System Data
	Model / Quantity	P06~P96 / 2~50 (*6)	Refer to System Data	Refer to System Data
Sound Pressure Level	dB(A)	57	54	54
Compressor Operating Range		7% - 100%	Refer to System Data	Refer to System Data
Compressor Type x Quantity		Refer to Module Data (*5)	Inverter scroll hermetic compressor x 1	Inverter scroll hermetic compressor x 1
Refrigerant		Refer to Module Data	R410A x 11 lbs. + 1 oz. (5.0 kg)	R410A x 11 lbs. + 1 oz. (5.0 kg)
Protection Devices	High Pressure	Refer to Module Data	High pressure sensor, High pressure switch at 4.15 MPa (601 psi)	High pressure sensor, High pressure switch at 4.15 MPa (601 psi)
	Inverter Circuit		Over-heat protection, Over-current protection	Over-heat protection, Over-current protection
	Compressor		Over-heat protection	Over-heat protection
AHRI Ratings (Ducted/Non-Ducted)	EER	12.5 / 13.8	Refer to System Data	
	IEER	22.4 / 25.7	Refer to System Data	
	COP	5.46 / 5.32	Refer to System Data	
	SCHE	19.3 / 20.0	Refer to System Data	

NOTES: (*1) <CITY MULTI indoor unit> Nominal cooling conditions (Test conditions are based on AHRI 1230) Indoor: 81°F D.B./68°F W.B. (27°C D.B./19°C W.B.), Water temperature: 86°F (30°C) Brine concentration 0%
Nominal heating conditions (Test conditions are based on AHRI 1230) Indoor: 68°F D.B. (20°C D.B.), Water temperature: 68°F (20°C) Brine concentration 0%

(*2) <PWFY-P36/72NMU-E-AU> Nominal cooling conditions Circulating water Temp.: 86°F (30°C) Pipe length: 25 ft. (7.6 m) Level difference: 0 ft. (0 m) Inlet water Temp.: 149°F (23°C) Water flow rate: 1.93 m³/h (8.3 gpm) <P36> / 3.86 m³/h (16.6 gpm) <P72> Brine concentration: 0%
Nominal heating conditions Circulating water Temp.: 68°F (20°C) Pipe length: 25 ft. (7.6 m) Level difference: 0 ft. (0 m) Inlet water Temp.: 86°F (30°C) Water flow rate: 2.15 m³/h (9.2 gpm) <P36> / 4.30 m³/h (18.5 gpm) <P72> Brine concentration: 0%

(*3) <PWFY-P36NMU-E-BU> Nominal heating conditions Circulating water Temp.: 68°F (20°C) Pipe length: 25 ft. (7.6 m) Level difference: 0 ft. (0 m) Inlet water Temp.: 149°F (65°C) Water flow rate: 2.15 m³/h (9.2 gpm) Brine concentration: 0%

(*4) <If using circulating water temperatures between 23° and 50° F, Dip switch 3-9 must be turned on and glycol (antifreeze) must be added to the water loop to prevent freezing down to 5° F.>

Note: Mitsubishi Electric (MESCA) supports the use of only MESCA supplied and approved accessories for proper functioning of the unit(s). Use of non-MESCA supported accessories will affect warranty coverage.

Specifications are subject to change without notice.

(*6) < Connectable branch pipe number is max. 48. (*7) < 1-1/8 (28.58) if exceeds 65m.>

* All electrical work shall comply with National (CEC) and local codes and regulations.

Should this document be altered or changed without MESCA's permission, it becomes null and void. MESCA assumes no responsibility for any consequences in such cases.

Module: PQRYP240ZSLMU-A1 - DIMENSIONS

Unit: mm(in)

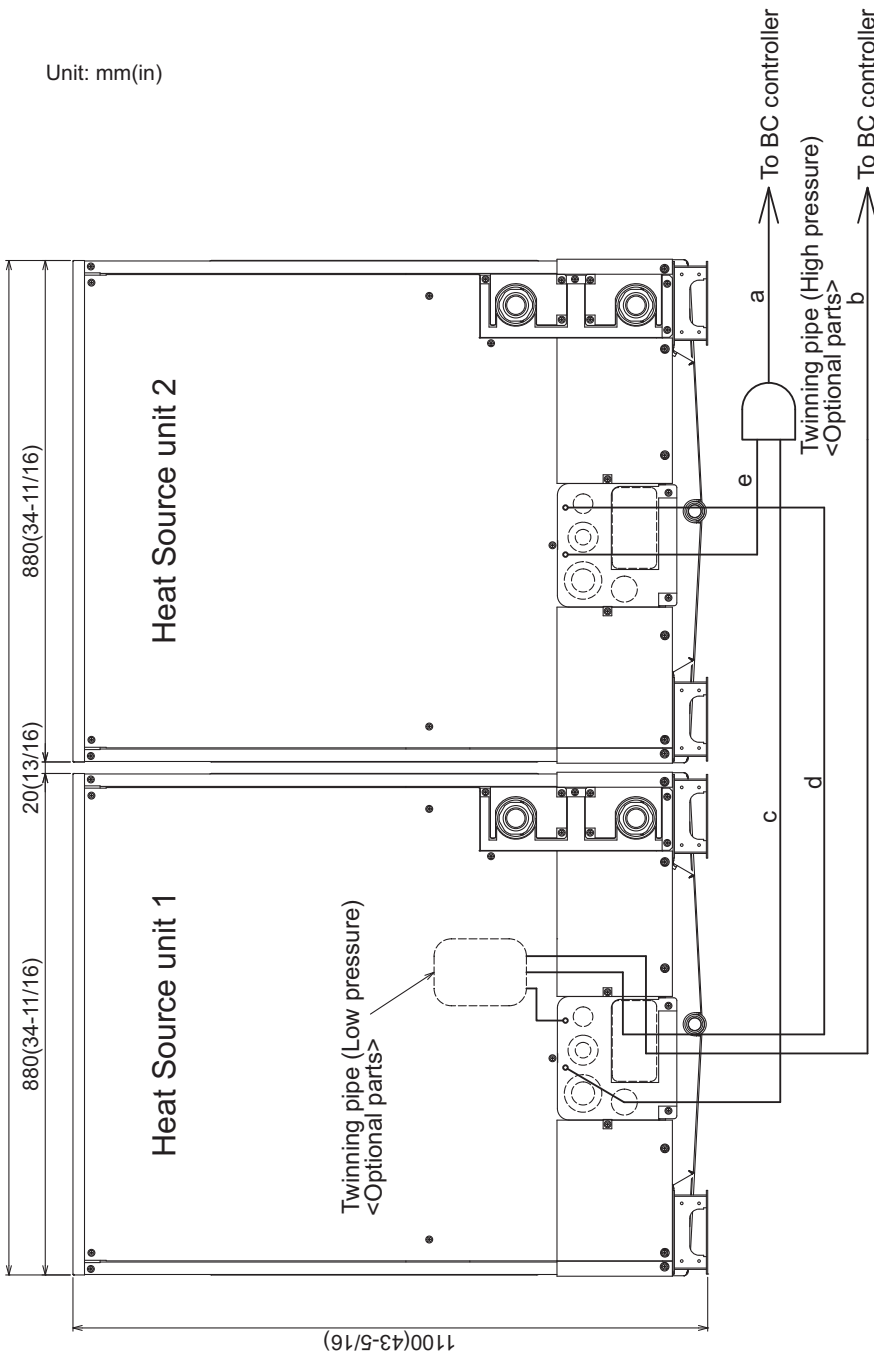

- Note 1. Connect the pipes as shown in the figure above. Refer to the table below for the pipe size.
 2. Twinning pipe (High pressure) should not be tilted more than 15 degrees from the horizontal plane.
 3. See the Installation Manual for the details of Twinning pipe installation.
 4. Only use the Twinning pipe by Mitsubishi (optional parts).

Twinning pipe connection size

Package unit name	PQRYP144ZSLMU-A1	PQRYP168ZSLMU-A1	PQRYP192ZSLMU-A1	PQRYP216ZSLMU-A1	PQRYP240ZSLMU-A1
Heat Source unit 1	PQRYP72ZLMU-A1	PQRYP96ZLMU-A1	PQRYP120ZLMU-A1	PQRYP120ZLMU-A1	PQRYP120ZLMU-A1
Heat Source unit 2	PQRYP72ZLMU-A1	PQRYP96ZLMU-A1	PQRYP120ZLMU-A1	PQRYP96ZLMU-A1	PQRYP120ZLMU-A1
Twinning pipe Kit (optional parts)	CMY-Q100CBK2				
High pressure	ø22.2(7/8)				
Low pressure	ø28.58(1-1/8)				
BC controller~ Twinning pipe	ø22.2(7/8) *1				
	ø34.93(1-3/8)				

Unit model	High pressure c or e	Low pressure d
P72	ø5.88(5/8) *2	ø19.05(3/4) *2
P96	ø19.05(3/4)	ø22.2(7/8)
P120	ø19.05(3/4)	ø22.2(7/8)

*1. When the piping length is 65 m or longer, use the ø28.58(1-1/8) pipe for the part that exceeds 65 m.
 *2. When the package unit name "PQRYP168ZSLMU-A1", use the ø19.05(3/4) pipe for high pressure and the ø22.2(7/8) pipe for low pressure.

Should this document be altered or changed without MESCA's permission, it becomes null and void. MESCA assumes no responsibility for any consequences in such cases.

Modules: 1, 2 : PQRV-P120ZLMU-A1 - DIMENSIONS

Unit: mm(in)

- <Accessories>
- Refrigerant (high pressure) conn. pipe.....1pc. (P72/P96/P120; Packaged in the accessory kit)
 - Refrigerant (low pressure) conn. elbow.....1pc. (P72/P96/P120; Packaged in the accessory kit)
 - Water stopper.....1pc. (P72/P96/P120; Packaged in the accessory kit)
 - Sealing material for water stopper.....1pc. (P72/P96/P120; Packaged in the accessory kit)
 - Sealing material for field piping (high pressure, low pressure).....1pc. each (P72/P96/P120; Packaged in the accessory kit)
 - Sealing material for drain socket.....1pc. (P72/P96/P120; Packaged in the accessory kit)
 - Pipe cover for low pressure.....1pc. (P72/P96/P120; Packaged in the accessory kit)

- Note1. Close a hole of the water piping, the refrigerant piping, the power supply, and the control wiring and unused knockout holes with the putty etc. so as not to infiltrate rain water etc. (field erection work)
- Note2. At the time of product shipment, the front side piping specification serves as the local drainage connection. When connecting on the rear side, please remove the rear side plug sealing corks, and attach a front side. Ensure there is no leak after the attachment has been fitted.
- Note3. Take notice of service space as Fig.A. (In case of single installation, 600mm(23-5/8) or more of back space as front space makes easier access when servicing the unit from rear side.)
- Note4. If water pipes or refrigerant pipes stretch upward, required space for service and maintenance due to replacement of control box is shown in Fig.B.
- Note5. Environmental condition for installation: -20~40°C(DB) (-4~104 °F) as indoor installation.
- Note6. In case the temperature around the heat source unit has possibility to drop under 0°C(32 °F), be careful for the following point to prevent the pipe burst by the water pipe freeze-up.
- Circulate the water all the time even if the heat source unit is not in operation.
 - Drain the water from inside of the heat source unit when the heat source unit will not operate for a long term.
- Note7. Ensure that the drain piping is downward with a pitch of more than 1/100.
- Note8. At brazing of pipes, wrap the refrigerant service valve with wet cloth and keep the temperature of refrigerant service valve under 120°C(248 °F).

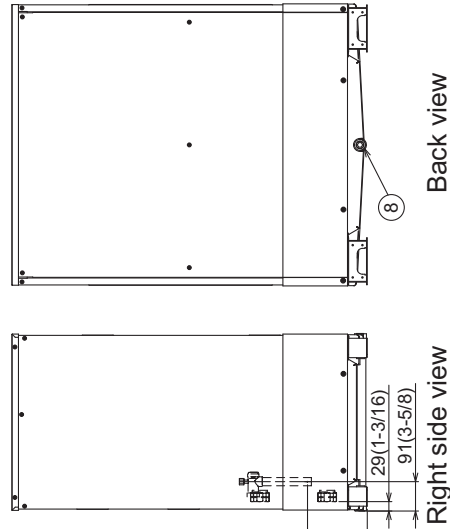
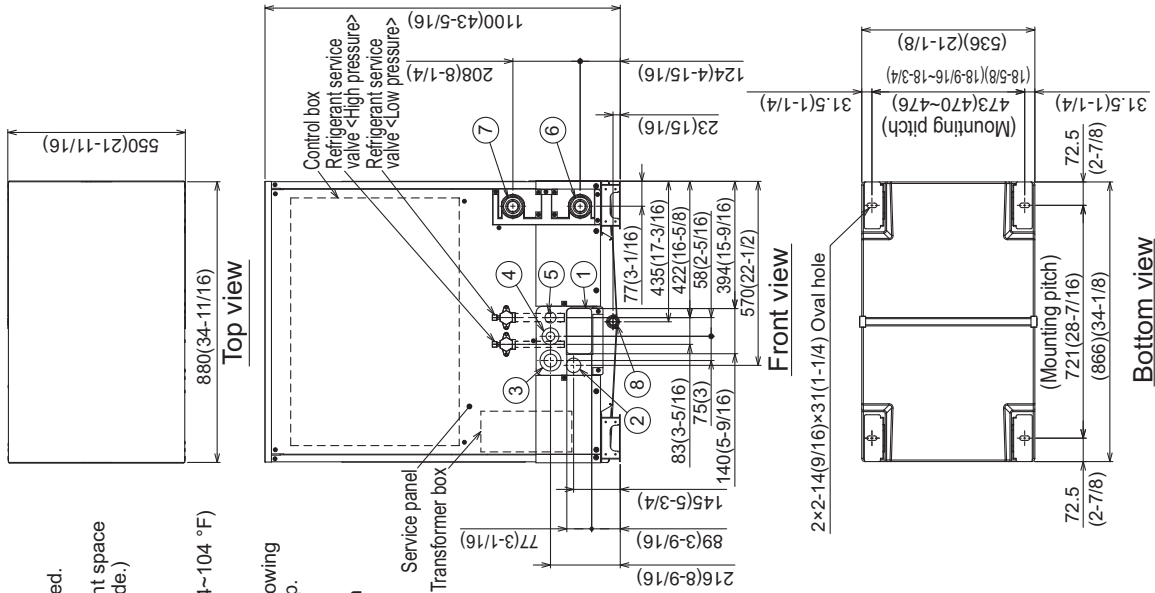

NO.	Usage	Specifications
①	For pipes	Front through hole 140 x 77 Knockout hole (5-9/16) (3-1/16)
②		Front through hole Front through hole (Uses when twinning kit (optional parts) is mounted.) ø45 Knockout hole (1-13/16)
③	For wires	Front through hole ø62.7 or ø34.5 Knockout hole (2-1/2) (1-3/8)
④		Front through hole ø43.7 or ø22.2 Knockout hole (1-3/4) (7/8)
⑤	For transmission cables	Front through hole ø34 Knockout hole (1-3/8)
⑥	Water pipe inlet	NPT1-1/2 Screw
⑦	Water pipe outlet	NPT1-1/2 Screw
⑧	Drain pipe	Rc3/4 Screw

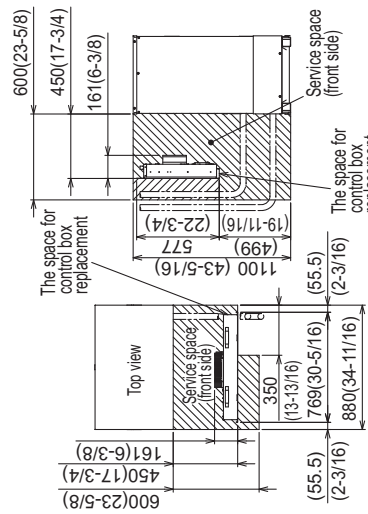

Fig.A

Fig.B

Connecting pipe specifications

Model	Refrigerant pipe		Service valve	
	High pressure	Low pressure	High pressure	Low pressure
PQRV-P120ZLMU-A1	ø15.88 Brazed (5/8) 1/2	ø19.05 Brazed (3/4) 1/2	ø19.05 (3/4)	ø25.4 (1)
PQRV-P96ZLMU-A1	ø19.05 Brazed (3/4) 1/2	ø22.2 Brazed (7/8) 1/2		
PQRV-P120ZLMU-A1				

- *1. Connect by using the connecting pipes and elbow that are supplied.
- *2. Use the pipe joint (field supply) and connect to the refrigerant service valve piping.

Should this document be altered or changed without MESCA's permission, it becomes null and void. MESCA assumes no responsibility for any consequences in such cases.

Twining Kit: CMY-Q100CBK2

CMY-Q100CBK2

Low-pressure pipe twining kit

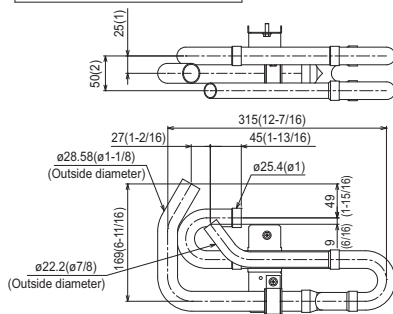

<Elbow pipe(Accessory)>

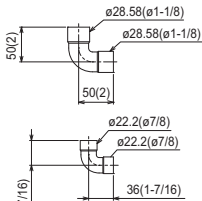

<Accessory>

Fixing screw	••• 1
Insulation cover	••• 1
Pipe cover (150mm(5-15/16) Length)	••• 2
Pipe cover (60mm(2-3/8) Length)	••• 1
Pipe cover (80mm(3-3/16) Length)	••• 2
Cable tie	••• 2
Water stopper	••• 1
Sealing material (Small)	••• 1
Sealing material (Large)	••• 1

<Pipe for routing through the front (Accessory)>

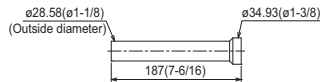

High-pressure twining pipe

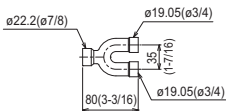

<Pipe for routing through the front (Accessory)>

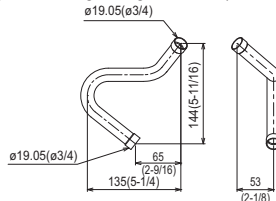

Note 1. Refer to the figure below for the installation position of the high-pressure twining pipe.

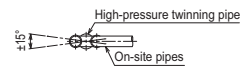

Inclination tolerance of the high-pressure twining pipe is $\pm 15^\circ$ relative to the ground.

2. Pipe diameter is indicated by inside diameter.

Note 1. Reference the attitude angle of the branch pipe below the fig.

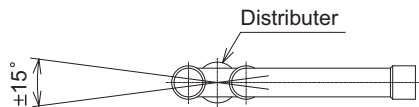

The angle of the branch pipe for high pressure is within $\pm 15^\circ$

2. Use the attached pipe to braze the port-opening of the distributor.
3. Pipe diameter is indicated by inside diameter.

Should this document be altered or changed without MESCA's permission, it becomes null and void. MESCA assumes no responsibility for any consequences in such cases.

Notes:

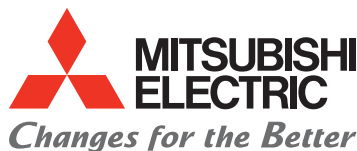

for a greener tomorrow

