

AIR CONDITIONING SYSTEMS

CITY MULTI

DATA BOOK

MODEL

PURY-EP72-432T(S)NU-A (-BS)

PURY-EP72-432Y(S)NU-A (-BS)

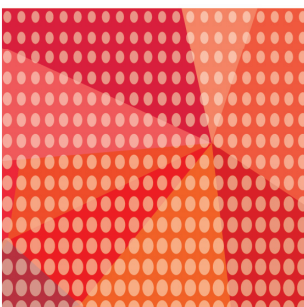

Heat Recovery R2-Series (High efficiency) - 208-230 V



Type(BTU/h)	72K
Model Name	PURY-EP72TNU-A(-BS)



Type(BTU/h)	96K	120K	144K
Model Name	PURY-EP96TNU-A(-BS)	PURY-EP120TNU-A(-BS)	PURY-EP144TNU-A(-BS)



Type(BTU/h)	168K
Model Name	PURY-EP168TNU-A(-BS)

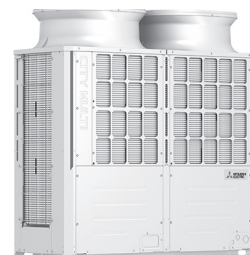

Type(BTU/h)	192K	216K	240K
Model Name	PURY-EP192TNU-A(-BS)	PURY-EP216TNU-A(-BS)	PURY-EP240TNU-A(-BS)



Type(BTU/h)	192K	216K	240K
Model Name	PURY-EP192TSNU-A(-BS)	PURY-EP216TSNU-A(-BS)	PURY-EP240TSNU-A(-BS)
Type(BTU/h)	264K	288K	
Model Name	PURY-EP264TSNU-A(-BS)	PURY-EP288TSNU-A(-BS)	



Type(BTU/h)	312K
Model Name	PURY-EP312TSNU-A(-BS)



Type(BTU/h)	336K
Model Name	PURY-EP336TSNU-A(-BS)



Type(BTU/h)	384K	432K
Model Name	PURY-EP384TSNU-A(-BS)	PURY-EP432TSNU-A(-BS)

Heat Recovery R2-Series (High efficiency) - 460 V



Type(BTU/h)	72K
Model Name	PURY-EP72YNU-A(-BS)



Type(BTU/h)	96K	120K	144K
Model Name	PURY-EP96YNU-A(-BS)	PURY-EP120YNU-A(-BS)	PURY-EP144YNU-A(-BS)



Type(BTU/h)	168K
Model Name	PURY-EP168YNU-A(-BS)

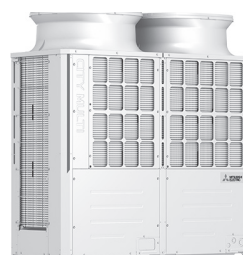

Type(BTU/h)	192K	216K	240K
Model Name	PURY-EP192YNU-A(-BS)	PURY-EP216YNU-A(-BS)	PURY-EP240YNU-A(-BS)



Type(BTU/h)	192K	216K	240K
Model Name	PURY-EP192YSNU-A(-BS)	PURY-EP216YSNU-A(-BS)	PURY-EP240YSNU-A(-BS)
Type(BTU/h)	264K	288K	
Model Name	PURY-EP264YSNU-A(-BS)	PURY-EP288YSNU-A(-BS)	



Type(BTU/h)	312K
Model Name	PURY-EP312YSNU-A(-BS)



Type(BTU/h)	336K
Model Name	PURY-EP336YSNU-A(-BS)



Type(BTU/h)	384K	432K
Model Name	PURY-EP384YSNU-A(-BS)	PURY-EP432YSNU-A(-BS)

PURY-EP-T(S)NU-A, PURY-EP-Y(S)NU-A

1. SPECIFICATIONS	2
1-1. AHRI 1230-2014 condition	2
1-2. AHRI 1230-2021 condition	36
2. EXTERNAL DIMENSIONS	70
3. CENTER OF GRAVITY	94
4. ELECTRICAL WIRING DIAGRAMS	96
5. SOUND LEVELS	104
5-1. Sound levels in cooling mode	104
5-2. Sound levels in heating mode	107
6. VIBRATION LEVEL	110
7. OPERATION TEMPERATURE RANGE	111
8. CAPACITY TABLES	112
8-1. Selection of Cooling/Heating Units	112
8-2. Correction by temperature	122
8-3. Correction by total indoor	176
8-4. Correction by refrigerant piping length	185
8-5. Correction at frost and defrost	189
8-6. Correction at evaporation-temperature (ET) control	190
9. OPTIONAL PARTS	191
9-1. JOINT and REDUCER	191
9-2. OUTDOOR TWINNING KIT	195
9-3. JOINT KIT "CMY-R160-J1" FOR BC CONTROLLER	196
9-4. PANEL HEATER	197
10. ELECTRICAL WORK	199
10-1. General cautions	199
10-2. Power supply for Outdoor unit	200
10-3. Power cable specifications	201
10-4. Power supply examples	202
11. M-NET CONTROL	204
11-1. Transmission cable length limitation	204
11-2. Transmission cable specifications	205
11-3. System configuration restrictions	206
11-4. Address setting	210
12. PIPING DESIGN	220
12-1. R410A Piping material	220
12-2. Piping Design	222
12-3. Refrigerant charging calculation	231
12-4. Compatibility	235
13. OUTDOOR INSTALLATION	236
13-1. General requirements for installation	236
13-2. Spacing	237
13-3. Piping direction	239
13-4. Weather countermeasure	244
13-5. Countermeasure to wind	244
13-6. Precautions for installing a panel heater	244

1-1. AHRI 1230-2014 condition

PURY-EP-T(S)NU-A, Y(S)NU-A

Outdoor Model			PURY-EP72TNU-A (-BS)		
Indoor Model			Non-Ducted	Ducted	
Power source			3-phase 3-wire 208-230 V ±10% 60 Hz		
Cooling capacity (Nominal)	*1	BTU/h	72,000		
		kW	21.1		
	(208-230)	Power input	kW	4.44	
		Current input	A	13.6-12.3	
	(Rated)	BTU/h	69,000		
		kW	20.2		
(208-230)	Power input	kW	3.96	4.26	
	Current input	A	12.2-11.0	13.1-11.8	
Temp. range of cooling	Indoor	W.B.	59~75°F (15~24°C)		
	Outdoor	D.B.	23~126°F (-5~52°C)		
Heating capacity (Nominal)	*2	BTU/h	80,000		
		kW	23.4		
	(208-230)	Power input	kW	5.43	
		Current input	A	16.7-15.1	
	(Rated)	BTU/h	76,000		
		kW	22.3		
(208-230)	Power input	kW	4.77	5.28	
	Current input	A	14.7-13.3	16.2-14.7	
Temp. range of heating	Indoor	D.B.	59~81°F (15~27°C)		
	Outdoor	W.B.	-13~60°F (-25~15.5°C)		
Indoor unit connectable	Total capacity	50~150% of outdoor unit capacity			
	Model/Quantity	P04~P96/1~18			
Sound power level (measured in anechoic room) *3		dB <A>	75.5/77.0		
Refrigerant piping diameter	High pressure	in. (mm)	5/8 (15.88) Brazed		
	Low pressure	in. (mm)	3/4 (19.05) Brazed		
Minimum Circuit Ampacity		A	33-30		
Maximum Overcurrent Protection		A	50-50		
FAN	Type x Quantity		Propeller fan x 1		
	Airflow rate	cfm	6,000		
		m ³ /min	170		
		L/s	2,830		
	Control, Driving mechanism		Inverter-control, Brushless DC motor		
	Motor output	kW	0.92		
*4 External static press.		0 in.WG (0 Pa)			
Compressor	Type x Quantity		Inverter scroll hermetic compressor x 1		
	Starting method		Inverter		
	Motor output	kW	3.8		
	Case heater	kW	-		
	Lubricant		MEL32		
External finish			Pre-coated galvanized steel sheet (+powder coating for -BS type) <MUNSELL 5Y 8/1>		
External dimension H x W x D	in.		71-5/8 x 36-1/4 x 29-3/16		
	mm		1,818 x 920 x 740		
Protection devices	High pressure protection		High pressure sensor, High pressure switch at 4.15 MPa (601 psi)		
	Inverter circuit (COMP./FAN)		Over-heat protection, Over-current protection		
	Fan motor		-		
Refrigerant	Type x original charge		R410A x 11 lbs + 7 oz (5.2 kg)		
	Control		Indoor LEV and BC controller		
Net weight		lbs (kg)	519 (235)		
Heat exchanger			Salt-resistant cross fin & aluminium tube		
HIC circuit (HIC: Heat Inter-Changer)			-		
Defrosting method			Auto-defrost mode (Reversed refrigerant cycle)		
Drawing	External		KL94R876		
	Wiring		KE94G672		
Standard attachment	Document		Installation Manual		
	Accessory		Details refer to External Drw		
Optional parts			joint: CMY-Y102SS-G2, CMY-Y102LS-G2, CMY-R160-J1 BC controller: CMB-P104, 106, 108, 1012, 1016NU-J1 Main BC controller: CMB-P108, 1012, 1016NU-JA1, CMB-P1016NU-KA1 Sub BC controller: CMB-P104, 108NU-KB1		
Remarks			Details on foundation work, duct work, insulation work, electrical wiring, power source switch, and other items shall be referred to the Installation Manual.		

Notes:	Unit converter
1.Nominal cooling conditions (Test conditions are based on AHRI 1230) Indoor: 80°F.D.B./67°F.W.B. (26.7°C.D.B./19.4°C.W.B.), Outdoor: 95°F.D.B. (35°C.D.B.)	BTU/h =kW x 3,412
2.Nominal heating conditions (Test conditions are based on AHRI 1230) Indoor: 70°F.D.B. (21.1°C.D.B.), Outdoor: 47°F.D.B./43°F.W.B. (8.3°C.D.B./6.1°C.W.B.)	cfm =m ³ /min x 35.31
3.Cooling mode/Heating mode	lbs =kg/0.4536
4.External static pressure option is available (0.12 in.WG, 0.24 in.WG, 0.32 in.WG/30 Pa, 60 Pa, 80 Pa).	
* Due to continuing improvement, above specifications may be subject to change without notice.	*Above specification data is subject to rounding variation.

1. SPECIFICATIONS

R2-Series (High efficiency)

PURY-EP-T(S)NU-A, Y(S)NU-A

Outdoor Model			PURY-EP96TNU-A (-BS)		
Indoor Model			Non-Ducted	Ducted	
Power source			3-phase 3-wire 208-230 V ±10% 60 Hz		
Cooling capacity (Nominal)	*1	BTU/h	96,000		
		kW	28.1		
	(208-230)	Power input	kW	6.11	
		Current input	A	18.8-17.0	
	(Rated)	BTU/h	92,000		
		kW	27.0		
	(208-230)	Power input	kW	5.55	5.76
		Current input	A	17.1-15.4	17.7-16.0
Temp. range of cooling	Indoor	W.B.	59~75°F (15~24°C)		
	Outdoor	D.B.	23~126°F (-5~52°C)		
Heating capacity (Nominal)	*2	BTU/h	108,000		
		kW	31.7		
	(208-230)	Power input	kW	7.40	
		Current input	A	22.8-20.6	
	(Rated)	BTU/h	103,000		
		kW	30.2		
	(208-230)	Power input	kW	6.72	6.98
		Current input	A	20.7-18.7	21.5-19.4
Temp. range of heating	Indoor	D.B.	59~81°F (15~27°C)		
	Outdoor	W.B.	-13~60°F (-25~15.5°C)		
Indoor unit connectable	Total capacity	50~150% of outdoor unit capacity			
	Model/Quantity	P04~P96/1~24			
Sound power level (measured in anechoic room) *3	dB <A>	77.5/79.0			
Refrigerant piping diameter	High pressure	in. (mm)	3/4 (19.05) Brazed		
	Low pressure	in. (mm)	7/8 (22.2) Brazed		
Minimum Circuit Ampacity	A	44-40			
Maximum Overcurrent Protection	A	70-60			
FAN	Type x Quantity	Propeller fan x 2			
	Airflow rate	cfm	7,400		
		m ³ /min	210		
		L/s	3,500		
	Control, Driving mechanism	Inverter-control, Brushless DC motor			
	Motor output	kW	0.46+0.46		
*4 External static press.	0 in.WG (0 Pa)				
Compressor	Type x Quantity	Inverter scroll hermetic compressor x 1			
	Starting method	Inverter			
	Motor output	kW	5.5		
	Case heater	kW	-		
	Lubricant	MEL32			
External finish	Pre-coated galvanized steel sheet (+powder coating for -BS type) <MUNSELL 5Y 8/1>				
External dimension H x W x D	in.	71-5/8 x 48-7/8 x 29-3/16			
	mm	1,818 x 1,240 x 740			
Protection devices	High pressure protection	High pressure sensor, High pressure switch at 4.15 MPa (601 psi)			
	Inverter circuit (COMP./FAN)	Over-heat protection, Over-current protection			
	Fan motor	-			
Refrigerant	Type x original charge	R410A x 17 lbs + 10 oz (8.0 kg)			
	Control	Indoor LEV and BC controller			
Net weight	lbs (kg)	613 (278)			
Heat exchanger	Salt-resistant cross fin & aluminium tube				
HIC circuit (HIC: Heat Inter-Changer)	-				
Defrosting method	Auto-defrost mode (Reversed refrigerant cycle)				
Drawing	External	KL94R877			
	Wiring	KE94G655			
Standard attachment	Document	Installation Manual			
	Accessory	Details refer to External Drw			
Optional parts	joint: CMY-Y102SS-G2, CMY-Y102LS-G2, CMY-R160-J1 BC controller: CMB-P104, 106, 108, 1012, 1016NU-J1 Main BC controller: CMB-P108, 1012, 1016NU-JA1, CMB-P1016NU-KA1 Sub BC controller: CMB-P104, 108NU-KB1				
Remarks	Details on foundation work, duct work, insulation work, electrical wiring, power source switch, and other items shall be referred to the Installation Manual.				

Notes:	1.Nominal cooling conditions (Test conditions are based on AHRI 1230) Indoor: 80°F D.B./67°F W.B. (26.7°C D.B./19.4°C W.B.), Outdoor: 95°F D.B. (35°C D.B.)	Unit converter
	2.Nominal heating conditions (Test conditions are based on AHRI 1230) Indoor: 70°F D.B. (21.1°C D.B.), Outdoor: 47°F D.B./43°F W.B. (8.3°C D.B./6.1°C W.B.)	BTU/h =kW x 3,412
	3.Cooling mode/Heating mode	cfm =m ³ /min x 35.31
	4.External static pressure option is available (0.12 in.WG, 0.24 in.WG, 0.32 in.WG/30 Pa, 60 Pa, 80 Pa).	lbs =kg/0.4536
* Due to continuing improvement, above specifications may be subject to change without notice.		*Above specification data is subject to rounding variation.

1. SPECIFICATIONS

R2-Series (High efficiency)

PURY-EP-T(S)NU-A, Y(S)NU-A

Outdoor Model			PURY-EP120TNU-A (-BS)		
Indoor Model			Non-Ducted	Ducted	
Power source			3-phase 3-wire 208-230 V ±10% 60 Hz		
Cooling capacity (Nominal)	*1	BTU/h	120,000		
		kW	35.2		
	(208-230)	Power input	kW		8.43
		Current input	A		25.9-23.5
	(Rated)	BTU/h	114,000		
		kW	33.4		
	(208-230)	Power input	7.70	7.91	
		Current input	23.7-21.4	24.3-22.0	
Temp. range of cooling	Indoor	W.B.	59~75°F (15~24°C)		
	Outdoor	D.B.	23~126°F (-5~52°C)		
Heating capacity (Nominal)	*2	BTU/h	135,000		
		kW	39.6		
	(208-230)	Power input	kW		9.89
		Current input	A		30.5-27.5
	(Rated)	BTU/h	129,000		
		kW	37.8		
	(208-230)	Power input	8.95	9.35	
		Current input	27.6-24.9	28.8-26.0	
Temp. range of heating	Indoor	D.B.	59~81°F (15~27°C)		
	Outdoor	W.B.	-13~60°F (-25~15.5°C)		
Indoor unit connectable	Total capacity	50~150% of outdoor unit capacity			
	Model/Quantity	P04~P96/1~30			
Sound power level (measured in anechoic room) *3		dB <A>	80.5/80.5		
Refrigerant piping diameter	High pressure	in. (mm)	3/4 (19.05) Brazed		
	Low pressure	in. (mm)	1-1/8 (28.58) Brazed		
Minimum Circuit Ampacity		A	56-55		
Maximum Overcurrent Protection		A	90-90		
FAN	Type x Quantity		Propeller fan x 2		
	Airflow rate	cfm	8,300		
		m ³ /min	235		
		L/s	3,920		
	Control, Driving mechanism		Inverter-control, Brushless DC motor		
	*4 Motor output		kW	0.46+0.46	
External static press.		0 in.WG (0 Pa)			
Compressor	Type x Quantity		Inverter scroll hermetic compressor x 1		
	Starting method		Inverter		
	Motor output		kW	7.6	
	Case heater		kW	-	
	Lubricant		MEL32		
External finish		Pre-coated galvanized steel sheet (+powder coating for -BS type) <MUNSELL 5Y 8/1>			
External dimension H x W x D		in.	71-5/8 x 48-7/8 x 29-3/16		
		mm	1,818 x 1,240 x 740		
Protection devices	High pressure protection		High pressure sensor, High pressure switch at 4.15 MPa (601 psi)		
	Inverter circuit (COMP./FAN)		Over-heat protection, Over-current protection		
	Fan motor		-		
Refrigerant	Type x original charge		R410A x 17 lbs + 10 oz (8.0 kg)		
	Control		Indoor LEV and BC controller		
Net weight		lbs (kg)	622 (282)		
Heat exchanger		Salt-resistant cross fin & aluminium tube			
HIC circuit (HIC: Heat Inter-Changer)		-			
Defrosting method		Auto-defrost mode (Reversed refrigerant cycle)			
Drawing	External		KL94R877		
	Wiring		KE94G655		
Standard attachment	Document		Installation Manual		
	Accessory		Details refer to External Drw		
Optional parts		joint: CMY-Y102SS-G2, CMY-Y102LS-G2, CMY-R160-J1 BC controller: CMB-P104, 106, 108, 1012, 1016NU-J1 Main BC controller: CMB-P108, 1012, 1016NU-JA1, CMB-P1016NU-KA1 Sub BC controller: CMB-P104, 108NU-KB1			
Remarks		Details on foundation work, duct work, insulation work, electrical wiring, power source switch, and other items shall be referred to the Installation Manual.			

Notes:	1.Nominal cooling conditions (Test conditions are based on AHRI 1230) Indoor: 80°F D.B./67°F W.B. (26.7°C D.B./19.4°C W.B.), Outdoor: 95°F D.B. (35°C D.B.)	Unit converter BTU/h =kW x 3,412 cfm =m ³ /min x 35.31 lbs =kg/0.4536
	2.Nominal heating conditions (Test conditions are based on AHRI 1230) Indoor: 70°F D.B. (21.1°C D.B.), Outdoor: 47°F D.B./43°F W.B. (8.3°C D.B./6.1°C W.B.)	
	3.Cooling mode/Heating mode	
	4.External static pressure option is available (0.12 in.WG, 0.24 in.WG, 0.32 in.WG/30 Pa, 60 Pa, 80 Pa).	
* Due to continuing improvement, above specifications may be subject to change without notice.		*Above specification data is subject to rounding variation.

1. SPECIFICATIONS

R2-Series (High efficiency)

PURY-EP-T(S)NU-A, Y(S)NU-A

Outdoor Model		PURY-EP144TNU-A (-BS)		
Indoor Model		Non-Ducted	Ducted	
Power source		3-phase 3-wire 208-230 V ±10% 60 Hz		
Cooling capacity (Nominal)	*1	BTU/h	144,000	
		kW	42.2	
	(208-230)	Power input	11.03	
		Current input	34.0-30.7	
	(Rated)	BTU/h	137,000	
		kW	40.2	
	(208-230)	Power input	10.04	10.38
		Current input	30.9-28.0	32.0-28.9
Temp. range of cooling	Indoor	W.B.	59~75°F (15~24°C)	
	Outdoor	D.B.	23~126°F (-5~52°C)	
Heating capacity (Nominal)	*2	BTU/h	160,000	
		kW	46.9	
	(208-230)	Power input	12.34	
		Current input	38.0-34.4	
	(Rated)	BTU/h	152,000	
		kW	44.5	
	(208-230)	Power input	11.08	11.76
		Current input	34.1-30.9	36.2-32.8
Temp. range of heating	Indoor	D.B.	59~81°F (15~27°C)	
	Outdoor	W.B.	-13~60°F (-25~15.5°C)	
Indoor unit connectable	Total capacity	50~150% of outdoor unit capacity		
	Model/Quantity	P04~P96/1~36		
Sound power level (measured in anechoic room) *3		dB <A>	85.5/85.5	
Refrigerant piping diameter	High pressure	in. (mm)	7/8 (22.2) Brazed	
	Low pressure	in. (mm)	1-1/8 (28.58) Brazed	
Minimum Circuit Ampacity		A	60-60	
Maximum Overcurrent Protection		A	100-100	
FAN	Type x Quantity		Propeller fan x 2	
	Airflow rate	cfm	9,550	
		m ³ /min	270	
		L/s	4,500	
	Control, Driving mechanism		Inverter-control, Brushless DC motor	
	Motor output	kW	0.46+0.46	
*4	External static press.		0 in.WG (0 Pa)	
Compressor	Type x Quantity		Inverter scroll hermetic compressor x 1	
	Starting method		Inverter	
	Motor output	kW	9.8	
	Case heater	kW	-	
	Lubricant		MEL32	
External finish		Pre-coated galvanized steel sheet (+powder coating for -BS type) <MUNSELL 5Y 8/1>		
External dimension H x W x D		in.	71-5/8 x 48-7/8 x 29-3/16	
		mm	1,818 x 1,240 x 740	
Protection devices	High pressure protection		High pressure sensor, High pressure switch at 4.15 MPa (601 psi)	
	Inverter circuit (COMP./FAN)		Over-heat protection, Over-current protection	
	Fan motor		-	
Refrigerant	Type x original charge		R410A x 23 lbs + 12 oz (10.8 kg)	
	Control		Indoor LEV and BC controller	
Net weight		lbs (kg)	680 (308)	
Heat exchanger		Salt-resistant cross fin & aluminium tube		
HIC circuit (HIC: Heat Inter-Changer)		-		
Defrosting method		Auto-defrost mode (Reversed refrigerant cycle)		
Drawing	External		KL94R877	
	Wiring		KE94G655	
Standard attachment	Document		Installation Manual	
	Accessory		Details refer to External Drw	
Optional parts		joint: CMY-Y102SS-G2, CMY-Y102LS-G2, CMY-R160-J1 Main BC controller: CMB-P108, 1012, 1016NU-JA1, CMB-P1016NU-KA1 Sub BC controller: CMB-P104, 108NU-KB1		
Remarks		Details on foundation work, duct work, insulation work, electrical wiring, power source switch, and other items shall be referred to the Installation Manual.		

Notes:	Unit converter
1.Nominal cooling conditions (Test conditions are based on AHRI 1230) Indoor: 80°F D.B./67°F W.B. (26.7°C D.B./19.4°C W.B.), Outdoor: 95°F D.B. (35°C D.B.)	BTU/h =kW x 3,412
2.Nominal heating conditions (Test conditions are based on AHRI 1230) Indoor: 70°F D.B. (21.1°C D.B.), Outdoor: 47°F D.B./43°F W.B. (8.3°C D.B./6.1°C W.B.)	cfm =m ³ /min x 35.31
3.Cooling mode/Heating mode	lbs =kg/0.4536
4.External static pressure option is available (0.12 in.WG, 0.24 in.WG, 0.32 in.WG/30 Pa, 60 Pa, 80 Pa).	
* Due to continuing improvement, above specifications may be subject to change without notice.	*Above specification data is subject to rounding variation.

1. SPECIFICATIONS

R2-Series (High efficiency)

PURY-EP-T(S)NU-A, Y(S)NU-A

Outdoor Model			PURY-EP168TNU-A (-BS)		
Indoor Model			Non-Ducted	Ducted	
Power source			3-phase 3-wire 208-230 V ±10% 60 Hz		
Cooling capacity (Nominal)	*1	BTU/h	168,000		
		kW	49.2		
	(208-230)	Power input	13.99		
		Current input	43.1-39.0		
	(Rated)	BTU/h	161,000		
		kW	47.2		
	(208-230)	Power input	12.92	12.98	
		Current input	39.8-36.0	40.0-36.2	
Temp. range of cooling	Indoor	W.B.	59~75°F (15~24°C)		
	Outdoor	D.B.	23~126°F (-5~52°C)		
Heating capacity (Nominal)	*2	BTU/h	188,000		
		kW	55.1		
	(208-230)	Power input	15.17		
		Current input	46.7-42.3		
	(Rated)	BTU/h	179,000		
		kW	52.5		
	(208-230)	Power input	13.32	14.77	
		Current input	41.0-37.1	45.5-41.1	
Temp. range of heating	Indoor	D.B.	59~81°F (15~27°C)		
	Outdoor	W.B.	-13~60°F (-25~15.5°C)		
Indoor unit connectable	Total capacity	50~150% of outdoor unit capacity			
	Model/Quantity	P04~P96/1~42			
Sound power level (measured in anechoic room) *3		dB <A>	81.5/85.5		
Refrigerant piping diameter	High pressure	in. (mm)	7/8 (22.2) Brazed		
	Low pressure	in. (mm)	1-1/8 (28.58) Brazed		
Minimum Circuit Ampacity		A	70-70		
Maximum Overcurrent Protection		A	110-110		
FAN	Type x Quantity	Propeller fan x 2			
	Airflow rate	cfm	14,850		
		m ³ /min	420		
		L/s	7,000		
	Control, Driving mechanism	Inverter-control, Brushless DC motor			
	Motor output	kW	0.92±0.92		
*4 External static press.	0 in.WG (0 Pa)				
Compressor	Type x Quantity	Inverter scroll hermetic compressor x 1			
	Starting method	Inverter			
	Motor output	kW	12.2		
	Case heater	kW	-		
	Lubricant	MEL32			
External finish	Pre-coated galvanized steel sheet (+powder coating for -BS type) <MUNSELL 5Y 8/1>				
External dimension H x W x D	in.	71-5/8 x 68-15/16 x 29-3/16			
	mm	1,818 x 1,750 x 740			
Protection devices	High pressure protection	High pressure sensor, High pressure switch at 4.15 MPa (601 psi)			
	Inverter circuit (COMP./FAN)	Over-heat protection, Over-current protection			
	Fan motor	-			
Refrigerant	Type x original charge	R410A x 23 lbs + 12 oz (10.8 kg)			
	Control	Indoor LEV and BC controller			
Net weight	lbs (kg)	777 (352)			
Heat exchanger	Salt-resistant cross fin & aluminium tube				
HIC circuit (HIC: Heat Inter-Changer)	-				
Defrosting method	Auto-defrost mode (Reversed refrigerant cycle)				
Drawing	External	KL94R878			
	Wiring	KE94G654			
Standard attachment	Document	Installation Manual			
	Accessory	Details refer to External Drw			
Optional parts	joint: CMY-Y102SS-G2, CMY-Y102LS-G2, CMY-R160-J1 Main BC controller: CMB-P108, 1012, 1016NU-JA1, CMB-P1016NU-KA1 Sub BC controller: CMB-P104, 108NU-KB1				
Remarks	Details on foundation work, duct work, insulation work, electrical wiring, power source switch, and other items shall be referred to the Installation Manual.				

Notes:	Unit converter
1.Nominal cooling conditions (Test conditions are based on AHRI 1230) Indoor: 80°F D.B./67°F W.B. (26.7°C D.B./19.4°C W.B.), Outdoor: 95°F D.B. (35°C D.B.)	BTU/h =kW x 3.412
2.Nominal heating conditions (Test conditions are based on AHRI 1230) Indoor: 70°F D.B. (21.1°C D.B.), Outdoor: 47°F D.B./43°F W.B. (8.3°C D.B./6.1°C W.B.)	cfm =m ³ /min x 35.31
3.Cooling mode/Heating mode	lbs =kg/0.4536
4.External static pressure option is available (0.12 in.WG, 0.24 in.WG, 0.32 in.WG/30 Pa, 60 Pa, 80 Pa).	
* Due to continuing improvement, above specifications may be subject to change without notice.	*Above specification data is subject to rounding variation.

1. SPECIFICATIONS

R2-Series (High efficiency)

PURY-EP-T(S)NU-A, Y(S)NU-A

Outdoor Model			PURY-EP192TNU-A (-BS)		
Indoor Model			Non-Ducted	Ducted	
Power source			3-phase 3-wire 208-230 V ±10% 60 Hz		
Cooling capacity (Nominal)	*1	BTU/h	192,000		
		kW	56.3		
	(208-230)	Power input	kW	15.65	
		Current input	A	48.2-43.6	
	(Rated)	BTU/h	182,000		
		kW	53.3		
	(208-230)	Power input	kW	14.24	14.45
		Current input	A	43.9-39.7	44.5-40.3
Temp. range of cooling	Indoor	W.B.	59~75°F (15~24°C)		
	Outdoor	D.B.	23~126°F (-5~52°C)		
Heating capacity (Nominal)	*2	BTU/h	215,000		
		kW	63.0		
	(208-230)	Power input	kW	17.54	
		Current input	A	54.0-48.9	
	(Rated)	BTU/h	204,000		
		kW	59.8		
	(208-230)	Power input	kW	15.37	16.58
		Current input	A	47.4-42.8	51.1-46.2
Temp. range of heating	Indoor	D.B.	59~81°F (15~27°C)		
	Outdoor	W.B.	-13~60°F (-25~15.5°C)		
Indoor unit connectable	Total capacity	50~150% of outdoor unit capacity			
	Model/Quantity	P04~P96/1~48			
Sound power level (measured in anechoic room) *3	dB <A>	83.5/85.0			
Refrigerant piping diameter	High pressure	in. (mm)	7/8 (22.2) Brazed		
	Low pressure	in. (mm)	1-1/8 (28.58) Brazed		
Minimum Circuit Ampacity	A	80-75			
Maximum Overcurrent Protection	A	125-125			
FAN	Type x Quantity	Propeller fan x 2			
	Airflow rate	cfm	13,050		
		m ³ /min	370		
		L/s	6,170		
	Control, Driving mechanism	Inverter-control, Brushless DC motor			
	Motor output	kW	0.92+0.92		
*4 External static press.	0 in.WG (0 Pa)				
Compressor	Type x Quantity	Inverter scroll hermetic compressor x 1			
	Starting method	Inverter			
	Motor output	kW	13.2		
	Case heater	kW	-		
	Lubricant	MEL32			
External finish	Pre-coated galvanized steel sheet (+powder coating for -BS type) <MUNSELL 5Y 8/1>				
External dimension H x W x D	in.	71-5/8 x 68-15/16 x 29-3/16			
	mm	1,818 x 1,750 x 740			
Protection devices	High pressure protection	High pressure sensor, High pressure switch at 4.15 MPa (601 psi)			
	Inverter circuit (COMP./FAN)	Over-current protection			
	Fan motor	-			
Refrigerant	Type x original charge	R410A x 26 lbs + 1 oz (11.8 kg)			
	Control	Indoor LEV and BC controller			
Net weight	lbs (kg)	887 (402)			
Heat exchanger	Salt-resistant cross fin & aluminium tube				
HIC circuit (HIC: Heat Inter-Changer)	-				
Defrosting method	Auto-defrost mode (Reversed refrigerant cycle)				
Drawing	External	KB94C1J4			
	Wiring	KE94G984			
Standard attachment	Document	Installation Manual			
	Accessory	Details refer to External Drw			
Optional parts	joint: CMY-Y102SS-G2, CMY-Y102LS-G2, CMY-R160-J1 Main BC controller: CMB-P108, 1012, 1016NU-JA1, CMB-P1016NU-KA1 Sub BC controller: CMB-P104, 108NU-KB1				
Remarks	Details on foundation work, duct work, insulation work, electrical wiring, power source switch, and other items shall be referred to the Installation Manual.				

Notes:	Unit converter
1.Nominal cooling conditions (Test conditions are based on AHRI 1230) Indoor: 80°F D.B./67°F W.B. (26.7°C D.B./19.4°C W.B.), Outdoor: 95°F D.B. (35°C D.B.)	BTU/h =kW x 3,412
2.Nominal heating conditions (Test conditions are based on AHRI 1230) Indoor: 70°F D.B. (21.1°C D.B.), Outdoor: 47°F D.B./43°F W.B. (8.3°C D.B./6.1°C W.B.)	cfm =m ³ /min x 35.31
3.Cooling mode/Heating mode	lbs =kg/0.4536
4.External static pressure option is available (0.12 in.WG, 0.24 in.WG, 0.32 in.WG/30 Pa, 60 Pa, 80 Pa).	
* Due to continuing improvement, above specifications may be subject to change without notice.	*Above specification data is subject to rounding variation.

1. SPECIFICATIONS

R2-Series (High efficiency)

PURY-EP-T(S)NU-A, Y(S)NU-A

Outdoor Model			PURY-EP216TNU-A (-BS)		
Indoor Model			Non-Ducted	Ducted	
Power source			3-phase 3-wire 208-230 V ±10% 60 Hz		
Cooling capacity (Nominal)	*1	BTU/h	216,000		
		kW	63.3		
	(208-230)	Power input	18.66		
		Current input	57.5-52.0		
	(Rated)	BTU/h	206,000		
		kW	60.4		
	(208-230)	Power input	17.43	17.13	
		Current input	53.7-48.6	52.8-47.7	
Temp. range of cooling	Indoor	W.B.	59~75°F (15~24°C)		
	Outdoor	D.B.	23~126°F (-5~52°C)		
Heating capacity (Nominal)	*2	BTU/h	243,000		
		kW	71.2		
	(208-230)	Power input	20.43		
		Current input	63.0-56.9		
	(Rated)	BTU/h	232,000		
		kW	68.0		
	(208-230)	Power input	18.22	19.61	
		Current input	56.1-50.8	60.4-54.6	
Temp. range of heating	Indoor	D.B.	59~81°F (15~27°C)		
	Outdoor	W.B.	-13~60°F (-25~15.5°C)		
Indoor unit connectable	Total capacity	50~150% of outdoor unit capacity			
	Model/Quantity	P04~P96/2~50			
Sound power level (measured in anechoic room) *3		dB <A>	86.0/86.5		
Refrigerant piping diameter	High pressure	in. (mm)	7/8 (22.2) Brazed (1-1/8 (28.58) Brazed for the part that exceeds 65 m)		
	Low pressure	in. (mm)	1-3/8 (34.93) Brazed		
Minimum Circuit Ampacity		A	88-85		
Maximum Overcurrent Protection		A	150-150		
FAN	Type x Quantity		Propeller fan x 2		
	Airflow rate	cfm	14,100		
		m ³ /min	400		
		L/s	6,670		
	Control, Driving mechanism		Inverter-control, Brushless DC motor		
	Motor output	kW	0.92+0.92		
*4 External static press.		0 in.WG (0 Pa)			
Compressor	Type x Quantity		Inverter scroll hermetic compressor x 1		
	Starting method		Inverter		
	Motor output	kW	15.8		
	Case heater	kW	-		
	Lubricant		MEL32		
External finish			Pre-coated galvanized steel sheet (+powder coating for -BS type) <MUNSELL 5Y 8/1>		
External dimension H x W x D		in.	71-5/8 x 68-15/16 x 29-3/16		
		mm	1,818 x 1,750 x 740		
Protection devices	High pressure protection		High pressure sensor, High pressure switch at 4.15 MPa (601 psi)		
	Inverter circuit (COMP./FAN)		Over-current protection		
	Fan motor		-		
Refrigerant	Type x original charge		R410A x 26 lbs + 1 oz (11.8 kg)		
	Control		Indoor LEV and BC controller		
Net weight		lbs (kg)	887 (402)		
Heat exchanger			Salt-resistant cross fin & aluminium tube		
HIC circuit (HIC: Heat Inter-Changer)			-		
Defrosting method			Auto-defrost mode (Reversed refrigerant cycle)		
Drawing	External		KB94C1J4		
	Wiring		KE94G984		
Standard attachment	Document		Installation Manual		
	Accessory		Details refer to External Drw		
Optional parts			joint: CMY-Y102SS-G2, CMY-Y102LS-G2, CMY-R160-J1 Main BC controller: CMB-P108, 1012, 1016NU-JA1, CMB-P1016NU-KA1 Sub BC controller: CMB-P104, 108NU-KB1		
Remarks			Details on foundation work, duct work, insulation work, electrical wiring, power source switch, and other items shall be referred to the Installation Manual.		

Notes:	1.Nominal cooling conditions (Test conditions are based on AHRI 1230) Indoor: 80°FDB./67°FWB. (26.7°CDB./19.4°CWB.), Outdoor: 95°FDB. (35°CDB.)	Unit converter
	2.Nominal heating conditions (Test conditions are based on AHRI 1230) Indoor: 70°FDB. (21.1°CDB.), Outdoor: 47°FDB./43°FWB. (8.3°CDB./6.1°CWB.)	BTU/h =kW x 3.412
	3.Cooling mode/Heating mode	cfm =m ³ /min x 35.31
	4.External static pressure option is available (0.12 in.WG, 0.24 in.WG, 0.32 in.WG/30 Pa, 60 Pa, 80 Pa).	lbs =kg/0.4536
* Due to continuing improvement, above specifications may be subject to change without notice.		*Above specification data is subject to rounding variation.

1. SPECIFICATIONS

R2-Series (High efficiency)

Outdoor Model			PURY-EP240TNU-A (-BS)		
Indoor Model			Non-Ducted	Ducted	
Power source			3-phase 3-wire 208-230 V ±10% 60 Hz		
Cooling capacity (Nominal)	*1	BTU/h	224,000		
		kW	65.7		
	(208-230)	Power input	kW	21.39	
		Current input	A	65.9-59.6	
	(Rated)	BTU/h	222,000		
		kW	65.1		
	(208-230)	Power input	kW	20.20	19.24
		Current input	A	62.2-56.3	59.3-53.6
Temp. range of cooling	Indoor	W.B.	59~75°F (15~24°C)		
	Outdoor	D.B.	23~126°F (-5~52°C)		
Heating capacity (Nominal)	*2	BTU/h	250,000		
		kW	73.3		
	(208-230)	Power input	kW	21.79	
		Current input	A	67.2-60.7	
	(Rated)	BTU/h	240,000		
		kW	70.3		
	(208-230)	Power input	kW	19.96	20.40
		Current input	A	61.5-55.6	62.9-56.8
Temp. range of heating	Indoor	D.B.	59~81°F (15~27°C)		
	Outdoor	W.B.	-13~60°F (-25~15.5°C)		
Indoor unit connectable	Total capacity	50~150% of outdoor unit capacity			
	Model/Quantity	P04~P96/2~50			
Sound power level (measured in anechoic room) *3		dB <A>	88.0/87.0		
Refrigerant piping diameter	High pressure	in. (mm)	7/8 (22.2) Brazed (1-1/8 (28.58) Brazed for the part that exceeds 65 m)		
	Low pressure	in. (mm)	1-3/8 (34.93) Brazed		
Minimum Circuit Ampacity		A	88-88		
Maximum Overcurrent Protection		A	150-150		
FAN	Type x Quantity		Propeller fan x 2		
	Airflow rate	cfm	14,500		
		m ³ /min	410		
		L/s	6,830		
	Control, Driving mechanism		Inverter-control, Brushless DC motor		
	Motor output	kW	0.92+0.92		
*4	External static press.		0 in.WG (0 Pa)		
Compressor	Type x Quantity		Inverter scroll hermetic compressor x 1		
	Starting method		Inverter		
	Motor output	kW	17.0		
	Case heater	kW	-		
	Lubricant		MEL32		
External finish			Pre-coated galvanized steel sheet (+powder coating for -BS type) <MUNSELL 5Y 8/1>		
External dimension H x W x D		in.	71-5/8 x 68-15/16 x 29-3/16		
		mm	1,818 x 1,750 x 740		
Protection devices	High pressure protection		High pressure sensor, High pressure switch at 4.15 MPa (601 psi)		
	Inverter circuit (COMP./FAN)		Over-current protection		
	Fan motor		-		
Refrigerant	Type x original charge		R410A x 26 lbs + 1 oz (11.8 kg)		
	Control		Indoor LEV and BC controller		
Net weight		lbs (kg)	887 (402)		
Heat exchanger			Salt-resistant cross fin & aluminium tube		
HIC circuit (HIC: Heat Inter-Changer)			-		
Defrosting method			Auto-defrost mode (Reversed refrigerant cycle)		
Drawing	External		KB94C1J4		
	Wiring		KE94G984		
Standard attachment	Document		Installation Manual		
	Accessory		Details refer to External Drw		
Optional parts			joint: CMY-Y102SS-G2, CMY-Y102LS-G2, CMY-R160-J1 Main BC controller: CMB-P108, 1012, 1016NU-JA1, CMB-P1016NU-KA1 Sub BC controller: CMB-P104, 108NU-KB1		
Remarks			Details on foundation work, duct work, insulation work, electrical wiring, power source switch, and other items shall be referred to the Installation Manual.		

Notes:	Unit converter
1.Nominal cooling conditions (Test conditions are based on AHRI 1230) Indoor: 80°F D.B./67°F W.B. (26.7°C D.B./19.4°C W.B.), Outdoor: 95°F D.B. (35°C D.B.)	BTU/h =kW x 3,412
2.Nominal heating conditions (Test conditions are based on AHRI 1230) Indoor: 70°F D.B. (21.1°C D.B.), Outdoor: 47°F D.B./43°F W.B. (8.3°C D.B./6.1°C W.B.)	cfm =m ³ /min x 35.31
3.Cooling mode/Heating mode	lbs =kg/0.4536
4.External static pressure option is available (0.12 in.WG, 0.24 in.WG, 0.32 in.WG/30 Pa, 60 Pa, 80 Pa).	
* Due to continuing improvement, above specifications may be subject to change without notice.	*Above specification data is subject to rounding variation.

1. SPECIFICATIONS

R2-Series (High efficiency)

PURY-EP-T(S)NU-A, Y(S)NU-A

Outdoor Model			PURY-EP192TSNU-A (-BS)		
Indoor Model			Non-Ducted		Ducted
Power source			3-phase 3-wire 208-230 V ±10% 60 Hz		
Cooling capacity (Nominal)	*1	BTU/h	192,000		
		kW	56.3		
	(208-230)	Power input	13.60		
		Current input	41.9-37.9		
	(Rated)	BTU/h	183,000		
		kW	53.6		
(208-230)	Power input	12.35	12.83		
	Current input	38.0-34.4	39.5-35.7		
Temp. range of cooling	Indoor	W.B.	59~75°F (15~24°C)		
	Outdoor	D.B.	23~126°F (-5~52°C)		
Heating capacity (Nominal)	*2	BTU/h	215,000		
		kW	63.0		
	(208-230)	Power input	16.02		
		Current input	49.4-44.6		
	(Rated)	BTU/h	205,000		
		kW	60.1		
(208-230)	Power input	14.53	15.13		
	Current input	44.8-40.5	46.6-42.1		
Temp. range of heating	Indoor	D.B.	59~81°F (15~27°C)		
	Outdoor	W.B.	-13~60°F (-25~15.5°C)		
Indoor unit connectable	Total capacity	50~150% of outdoor unit capacity			
	Model/Quantity	P04~P96/1~48			
Sound power level (measured in anechoic room) *3	dB <A>	80.5/82.0			
Refrigerant piping diameter	High pressure	in. (mm)	7/8 (22.2) Brazed		
	Low pressure	in. (mm)	1-1/8 (28.58) Brazed		

Set Model			PURY-EP96TNU-A (-BS)		PURY-EP96TNU-A (-BS)	
Model			PURY-EP96TNU-A (-BS)		PURY-EP96TNU-A (-BS)	
Minimum Circuit Ampacity	A	44-40		44-40		
Maximum Overcurrent Protection	A	70-60		70-60		
FAN	Type x Quantity	Propeller fan x 2		Propeller fan x 2		
	Airflow rate	cfm	7,400		7,400	
		m ³ /min	210		210	
		L/s	3,500		3,500	
	Control, Driving mechanism	Inverter-control, Brushless DC motor		Inverter-control, Brushless DC motor		
	Motor output	kW	0.46+0.46		0.46+0.46	
External static press.	0 in.WG (0 Pa)		0 in.WG (0 Pa)			
Compressor	Type x Quantity	Inverter scroll hermetic compressor x 1		Inverter scroll hermetic compressor x 1		
	Starting method	Inverter		Inverter		
	Motor output	kW	5.5		5.5	
	Case heater	kW	-		-	
	Lubricant	MEL32		MEL32		
External finish	Pre-coated galvanized steel sheet (+powder coating for -BS type) <MUNSELL 5Y 8/1>		Pre-coated galvanized steel sheet (+powder coating for -BS type) <MUNSELL 5Y 8/1>			
External dimension H x W x D	in.	71-5/8 x 48-7/8 x 29-3/16		71-5/8 x 48-7/8 x 29-3/16		
	mm	1,818 x 1,240 x 740		1,818 x 1,240 x 740		
Protection devices	High pressure protection	High pressure sensor, High pressure switch at 4.15 MPa (601 psi)		High pressure sensor, High pressure switch at 4.15 MPa (601 psi)		
	Inverter circuit (COMP./FAN)	Over-heat protection, Over-current protection		Over-heat protection, Over-current protection		
	Fan motor	-		-		
Refrigerant	Type x original charge	R410A x 17 lbs + 10 oz (8.0 kg)		R410A x 17 lbs + 10 oz (8.0 kg)		
	Control	Indoor LEV and BC controller				
Net weight	lbs (kg)	613 (278)		613 (278)		
Heat exchanger	Salt-resistant cross fin & aluminium tube		Salt-resistant cross fin & aluminium tube			
HIC circuit (HIC: Heat Inter-Changer)	-		-			
Pipe between unit and distributor	High pressure	in. (mm)	3/4 (19.05) Brazed		3/4 (19.05) Brazed	
	Low pressure	in. (mm)	7/8 (22.2) Brazed		7/8 (22.2) Brazed	
Defrosting method	Auto-defrost mode (Reversed refrigerant cycle)					
Drawing	External	KL94R879				
	Wiring	KE94G655		KE94G655		
Standard attachment	Document	Installation Manual				
	Accessory	Details refer to External Drw				
Optional parts	Outdoor Twinning kit: CMY-R200NCBK joint: CMY-Y102SS-G2, CMY-Y102LS-G2, CMY-R160-J1 Main BC controller: CMB-P108, 1012, 1016NU-JA1, CMB-P1016NU-KA1 Sub BC controller: CMB-P104, 108NU-KB1					
Remarks	Details on foundation work, duct work, insulation work, electrical wiring, power source switch, and other items shall be referred to the Installation Manual.					

Notes:	Unit converter
1. Nominal cooling conditions (Test conditions are based on AHRI 1230) Indoor: 80°F D.B./67°F W.B. (26.7°C D.B./19.4°C W.B.), Outdoor: 95°F D.B. (35°C D.B.)	BTU/h = kW x 3,412
2. Nominal heating conditions (Test conditions are based on AHRI 1230) Indoor: 70°F D.B. (21.1°C D.B.), Outdoor: 47°F D.B./43°F W.B. (8.3°C D.B./6.1°C W.B.)	cfm = m ³ /min x 35.31
3. Cooling mode/Heating mode	lbs = kg/0.4536
4. External static pressure option is available (0.12 in.WG, 0.24 in.WG, 0.32 in.WG/30 Pa, 60 Pa, 80 Pa).	
* Due to continuing improvement, above specifications may be subject to change without notice.	*Above specification data is subject to rounding variation.

1. SPECIFICATIONS

R2-Series (High efficiency)

PURY-EP-T(S)NU-A, Y(S)NU-A

Outdoor Model			PURY-EP216TSNU-A (-BS)	
Indoor Model			Non-Ducted	Ducted
Power source			3-phase 3-wire 208-230 V ±10% 60 Hz	
Cooling capacity (Nominal)	*1	BTU/h	216,000	
		kW	63.3	
	(208-230)	Power input	16.06	
		Current input	49.5-44.7	
	(Rated)	BTU/h	206,000	
		kW	60.4	
(208-230)	Power input	14.61	15.12	
	Current input	45.0-40.7	46.6-42.1	
Temp. range of cooling	Indoor	W.B.	59~75°F (15~24°C)	
	Outdoor	D.B.	23~126°F (-5~52°C)	
Heating capacity (Nominal)	*2	BTU/h	243,000	
		kW	71.2	
	(208-230)	Power input	18.67	
		Current input	57.5-52.0	
	(Rated)	BTU/h	232,000	
		kW	68.0	
(208-230)	Power input	16.91	17.65	
	Current input	52.1-47.1	54.4-49.2	
Temp. range of heating	Indoor	D.B.	59~81°F (15~27°C)	
	Outdoor	W.B.	-13~60°F (-25~15.5°C)	
Indoor unit connectable	Total capacity		50~150% of outdoor unit capacity	
	Model/Quantity		P04-P96/2-50	
Sound power level (measured in anechoic room) *3		dB <A>	82.0/83.0	
Refrigerant	High pressure	in. (mm)	7/8 (22.2) Brazed (1-1/8 (28.58) Brazed for the part that exceeds 65 m)	
piping diameter	Low pressure	in. (mm)	1-3/8 (34.93) Brazed	

Set Model			PURY-EP120TNU-A (-BS)		PURY-EP96TNU-A (-BS)	
Minimum Circuit Ampacity		A	56-55		44-40	
Maximum Overcurrent Protection		A	90-90		70-60	
FAN	Type x Quantity		Propeller fan x 2		Propeller fan x 2	
	Airflow rate	cfm	8,300		7,400	
		m ³ /min	235		210	
		L/s	3,920		3,500	
	Control, Driving mechanism		Inverter-control, Brushless DC motor		Inverter-control, Brushless DC motor	
	Motor output	kW	0.46+0.46		0.46+0.46	
External static press.		0 in.WG (0 Pa)		0 in.WG (0 Pa)		
Compressor	Type x Quantity		Inverter scroll hermetic compressor x 1		Inverter scroll hermetic compressor x 1	
	Starting method		Inverter		Inverter	
	Motor output	kW	7.6		5.5	
	Case heater	kW	-		-	
	Lubricant		MEL32		MEL32	
External finish		Pre-coated galvanized steel sheet (+powder coating for -BS type) <MUNSELL 5Y 8/1>		Pre-coated galvanized steel sheet (+powder coating for -BS type) <MUNSELL 5Y 8/1>		
External dimension H x W x D		in.	71-5/8 x 48-7/8 x 29-3/16		71-5/8 x 48-7/8 x 29-3/16	
		mm	1,818 x 1,240 x 740		1,818 x 1,240 x 740	
Protection devices	High pressure protection		High pressure sensor, High pressure switch at 4.15 MPa (601 psi)		High pressure sensor, High pressure switch at 4.15 MPa (601 psi)	
	Inverter circuit (COMP./FAN)		Over-heat protection, Over-current protection		Over-heat protection, Over-current protection	
	Fan motor		-		-	
Refrigerant	Type x original charge		R410A x 17 lbs + 10 oz (8.0 kg)		R410A x 17 lbs + 10 oz (8.0 kg)	
	Control		Indoor LEV and BC controller			
Net weight		lbs (kg)	622 (282)		613 (278)	
Heat exchanger		Salt-resistant cross fin & aluminium tube		Salt-resistant cross fin & aluminium tube		
HIC circuit (HIC: Heat Inter-Changer)		-				
Pipe between unit and distributor	High pressure	in. (mm)	3/4 (19.05) Brazed		3/4 (19.05) Brazed	
	Low pressure	in. (mm)	1-1/8 (28.58) Brazed		7/8 (22.2) Brazed	
Defrosting method		Auto-defrost mode (Reversed refrigerant cycle)				
Drawing	External	KL94R879				
	Wiring	KE94G655		KE94G655		
Standard attachment	Document	Installation Manual				
	Accessory	Details refer to External Drw				
Optional parts		Outdoor Twinning kit: CMY-R200NCBK joint: CMY-Y102SS-G2,CMY-Y102LS-G2,CMY-R160-J1 Main BC controller: CMB-P108,1012,1016NU-JA1,CMB-P1016NU-KA1 Sub BC controller: CMB-P104,108NU-KB1				
Remarks		Details on foundation work, duct work, insulation work, electrical wiring, power source switch, and other items shall be referred to the Installation Manual.				

Notes:	Unit converter
1.Nominal cooling conditions (Test conditions are based on AHRI 1230) Indoor: 80°F D.B./67°F W.B. (26.7°C D.B./19.4°C W.B.), Outdoor: 95°F D.B. (35°C D.B.)	BTU/h =kW x 3.412
2.Nominal heating conditions (Test conditions are based on AHRI 1230) Indoor: 70°F D.B. (21.1°C D.B.), Outdoor: 47°F D.B./43°F W.B. (8.3°C D.B./6.1°C W.B.)	cfm =m ³ /min x 35.31
3.Cooling mode/Heating mode	lbs =kg/0.4536
4.External static pressure option is available (0.12 in.WG, 0.24 in.WG, 0.32 in.WG/30 Pa, 60 Pa, 80 Pa).	
* Due to continuing improvement, above specifications may be subject to change without notice.	*Above specification data is subject to rounding variation.

1. SPECIFICATIONS

R2-Series (High efficiency)

PURY-EP-T(S)NU-A, Y(S)NU-A

Outdoor Model			PURY-EP240TSNU-A (-BS)		
Indoor Model			Non-Ducted		Ducted
Power source			3-phase 3-wire 208-230 V ±10% 60 Hz		
Cooling capacity (Nominal)	*1	BTU/h	240,000		
		kW	70.3		
	(208-230)	Power input	19.17		
		Current input	59.1-53.4		
	(Rated)	BTU/h	228,000		
		kW	66.8		
	(208-230)	Power input	17.92	17.58	
		Current input	55.2-49.9	54.2-49.0	
Temp. range of cooling	Indoor	W.B.	59~75°F (15~24°C)		
	Outdoor	D.B.	23~126°F (-5~52°C)		
Heating capacity (Nominal)	*2	BTU/h	270,000		
		kW	79.1		
	(208-230)	Power input	22.03		
		Current input	67.9-61.4		
	(Rated)	BTU/h	258,000		
		kW	75.6		
	(208-230)	Power input	20.52	20.27	
		Current input	63.2-57.2	62.5-56.5	
Temp. range of heating	Indoor	D.B.	59~81°F (15~27°C)		
	Outdoor	W.B.	-13~60°F (-25~15.5°C)		
Indoor unit connectable	Total capacity	50~150% of outdoor unit capacity			
	Model/Quantity	P04~P96/2~50			
Sound power level (measured in anechoic room) *3	dB <A>	83.0/83.5			
Refrigerant piping diameter	High pressure	in. (mm)	7/8 (22.2) Brazed (1-1/8 (28.58) Brazed for the part that exceeds 65 m)		
	Low pressure	in. (mm)	1-3/8 (34.93) Brazed		

Set Model			PURY-EP120TNU-A (-BS)		PURY-EP120TNU-A (-BS)	
Model			PURY-EP120TNU-A (-BS)		PURY-EP120TNU-A (-BS)	
Minimum Circuit Ampacity	A		56-55		56-55	
Maximum Overcurrent Protection	A		90-90		90-90	
FAN	Type x Quantity		Propeller fan x 2		Propeller fan x 2	
	Airflow rate	cfm	8,300		8,300	
		m ³ /min	235		235	
		L/s	3,920		3,920	
	Control, Driving mechanism		Inverter-control, Brushless DC motor		Inverter-control, Brushless DC motor	
	Motor output	kW	0.46+0.46		0.46+0.46	
External static press.		0 in.WG (0 Pa)		0 in.WG (0 Pa)		
Compressor	Type x Quantity		Inverter scroll hermetic compressor x 1		Inverter scroll hermetic compressor x 1	
	Starting method		Inverter		Inverter	
	Motor output	kW	7.6		7.6	
	Case heater	kW	-		-	
	Lubricant		MEL32		MEL32	
External finish		Pre-coated galvanized steel sheet (+powder coating for -BS type) <MUNSELL 5Y 8/1>		Pre-coated galvanized steel sheet (+powder coating for -BS type) <MUNSELL 5Y 8/1>		
External dimension H x W x D		in.	71-5/8 x 48-7/8 x 29-3/16		71-5/8 x 48-7/8 x 29-3/16	
		mm	1,818 x 1,240 x 740		1,818 x 1,240 x 740	
Protection devices	High pressure protection		High pressure sensor, High pressure switch at 4.15 MPa (601 psi)		High pressure sensor, High pressure switch at 4.15 MPa (601 psi)	
	Inverter circuit (COMP./FAN)		Over-heat protection, Over-current protection		Over-heat protection, Over-current protection	
	Fan motor		-		-	
Refrigerant	Type x original charge		R410A x 17 lbs + 10 oz (8.0 kg)		R410A x 17 lbs + 10 oz (8.0 kg)	
	Control		Indoor LEV and BC controller			
Net weight	lbs (kg)		622 (282)		622 (282)	
Heat exchanger		Salt-resistant cross fin & aluminium tube		Salt-resistant cross fin & aluminium tube		
HIC circuit (HIC: Heat Inter-Changer)		-				
Pipe between unit and distributor	High pressure	in. (mm)	3/4 (19.05) Brazed		3/4 (19.05) Brazed	
	Low pressure	in. (mm)	1-1/8 (28.58) Brazed		1-1/8 (28.58) Brazed	
Defrosting method		Auto-defrost mode (Reversed refrigerant cycle)				
Drawing	External	KL94R879				
	Wiring	KE94G655		KE94G655		
Standard attachment	Document	Installation Manual				
	Accessory	Details refer to External Drw				
Optional parts		Outdoor Twinning kit: CMY-R200NCBK joint: CMY-Y102SS-G2, CMY-Y102LS-G2, CMY-R160-J1 Main BC controller: CMB-P108, 1012, 1016NU-JA1, CMB-P1016NU-KA1 Sub BC controller: CMB-P104, 108NU-KB1				
Remarks		Details on foundation work, duct work, insulation work, electrical wiring, power source switch, and other items shall be referred to the Installation Manual.				

Notes:	Unit converter
1. Nominal cooling conditions (Test conditions are based on AHRI 1230) Indoor: 80°F D.B./67°F W.B. (26.7°C D.B./19.4°C W.B.), Outdoor: 95°F D.B. (35°C D.B.)	BTU/h = kW x 3,412
2. Nominal heating conditions (Test conditions are based on AHRI 1230) Indoor: 70°F D.B. (21.1°C D.B.), Outdoor: 47°F D.B./43°F W.B. (8.3°C D.B./6.1°C W.B.)	cfm = m ³ /min x 35.31
3. Cooling mode/Heating mode	lbs = kg/0.4536
4. External static pressure option is available (0.12 in.WG, 0.24 in.WG, 0.32 in.WG/30 Pa, 60 Pa, 80 Pa).	
* Due to continuing improvement, above specifications may be subject to change without notice.	*Above specification data is subject to rounding variation.

1. SPECIFICATIONS

R2-Series (High efficiency)

PURY-EP-T(S)NU-A, Y(S)NU-A

Outdoor Model			PURY-EP264TSNU-A (-BS)		
Indoor Model			Non-Ducted		Ducted
Power source			3-phase 3-wire 208-230 V ±10% 60 Hz		
Cooling capacity (Nominal)	*1	BTU/h	264,000		
		kW	77.4		
	(208-230)	Power input	21.86		
		Current input	67.4-60.9		
	(Rated)	BTU/h	250,000		
		kW	73.3		
(208-230)	Power input	20.11	19.97		
	Current input	62.0-56.0	61.5-55.6		
Temp. range of cooling	Indoor	W.B.	59~75°F (15~24°C)		
	Outdoor	D.B.	23~126°F (-5~52°C)		
Heating capacity (Nominal)	*2	BTU/h	295,000		
		kW	86.5		
	(208-230)	Power input	24.56		
		Current input	75.7-68.5		
	(Rated)	BTU/h	280,000		
		kW	82.1		
(208-230)	Power input	22.58	22.68		
	Current input	69.6-62.9	69.9-63.2		
Temp. range of heating	Indoor	D.B.	59~81°F (15~27°C)		
	Outdoor	W.B.	-13~60°F (-25~15.5°C)		
Indoor unit connectable	Total capacity		50~150% of outdoor unit capacity		
	Model/Quantity		P04-P96/2-50		
Sound power level (measured in anechoic room) *3		dB <A>	87.0/87.0		
Refrigerant piping diameter	High pressure	in. (mm)	1-1/8 (28.58) Brazed		
	Low pressure	in. (mm)	1-3/8 (34.93) Brazed		

Set Model			PURY-EP144TNU-A (-BS)		PURY-EP120TNU-A (-BS)	
Minimum Circuit Ampacity		A	60-60		56-55	
Maximum Overcurrent Protection		A	100-100		90-90	
FAN	Type x Quantity		Propeller fan x 2		Propeller fan x 2	
	Airflow rate	cfm	9,550		8,300	
		m ³ /min	270		235	
		L/s	4,500		3,920	
	Control, Driving mechanism		Inverter-control, Brushless DC motor		Inverter-control, Brushless DC motor	
	Motor output	kW	0.46+0.46		0.46+0.46	
External static press.			0 in.WG (0 Pa)		0 in.WG (0 Pa)	
Compressor	Type x Quantity		Inverter scroll hermetic compressor x 1		Inverter scroll hermetic compressor x 1	
	Starting method		Inverter		Inverter	
	Motor output	kW	9.8		7.6	
	Case heater	kW	-		-	
	Lubricant		MEL32		MEL32	
External finish			Pre-coated galvanized steel sheet (+powder coating for -BS type) <MUNSELL 5Y 8/1>		Pre-coated galvanized steel sheet (+powder coating for -BS type) <MUNSELL 5Y 8/1>	
External dimension H x W x D		in.	71-5/8 x 48-7/8 x 29-3/16		71-5/8 x 48-7/8 x 29-3/16	
		mm	1,818 x 1,240 x 740		1,818 x 1,240 x 740	
Protection devices	High pressure protection		High pressure sensor, High pressure switch at 4.15 MPa (601 psi)		High pressure sensor, High pressure switch at 4.15 MPa (601 psi)	
	Inverter circuit (COMP./FAN)		Over-heat protection, Over-current protection		Over-heat protection, Over-current protection	
	Fan motor		-		-	
Refrigerant	Type x original charge		R410A x 23 lbs + 12 oz (10.8 kg)		R410A x 17 lbs + 10 oz (8.0 kg)	
	Control		Indoor LEV and BC controller			
Net weight		lbs (kg)	680 (308)		622 (282)	
Heat exchanger			Salt-resistant cross fin & aluminium tube		Salt-resistant cross fin & aluminium tube	
HIC circuit (HIC: Heat Inter-Changer)			-			
Pipe between unit and distributor	High pressure	in. (mm)	7/8 (22.2) Brazed		3/4 (19.05) Brazed	
	Low pressure	in. (mm)	1-1/8 (28.58) Brazed		1-1/8 (28.58) Brazed	
Defrosting method			Auto-defrost mode (Reversed refrigerant cycle)			
Drawing	External		KL94R879			
	Wiring		KE94G655		KE94G655	
Standard attachment	Document		Installation Manual			
	Accessory		Details refer to External Drw			
Optional parts			Outdoor Twinning kit: CMY-R300NCBK joint: CMY-Y102SS-G2,CMY-Y102LS-G2,CMY-R160-J1 Main BC controller: CMB-P108,1012,1016NU-JA1,CMB-P1016NU-KA1 Sub BC controller: CMB-P104,108NU-KB1			
Remarks			Details on foundation work, duct work, insulation work, electrical wiring, power source switch, and other items shall be referred to the Installation Manual.			

Notes:	Unit converter
1.Nominal cooling conditions (Test conditions are based on AHRI 1230) Indoor: 80°F D.B./67°F W.B. (26.7°C D.B./19.4°C W.B.), Outdoor: 95°F D.B. (35°C D.B.)	BTU/h =kW x 3,412
2.Nominal heating conditions (Test conditions are based on AHRI 1230) Indoor: 70°F D.B. (21.1°C D.B.), Outdoor: 47°F D.B./43°F W.B. (8.3°C D.B./6.1°C W.B.)	cfm =m ³ /min x 35.31
3.Cooling mode/Heating mode	lbs =kg/0.4536
4.External static pressure option is available (0.12 in.WG, 0.24 in.WG, 0.32 in.WG/30 Pa, 60 Pa, 80 Pa).	
* Due to continuing improvement, above specifications may be subject to change without notice.	*Above specification data is subject to rounding variation.

1. SPECIFICATIONS

R2-Series (High efficiency)

PURY-EP-T(S)NU-A, Y(S)NU-A

Outdoor Model			PURY-EP288TSNU-A (-BS)		
Indoor Model			Non-Ducted		Ducted
Power source			3-phase 3-wire 208-230 V ±10% 60 Hz		
Cooling capacity (Nominal)	*1	BTU/h	288,000		
		kW	84.4		
	(208-230)	Power input	24.83		
		Current input	76.5-69.2		
	(Rated)	BTU/h	274,000		
		kW	80.3		
(208-230)	Power input	23.02	22.95		
	Current input	70.9-64.2	70.7-64.0		
Temp. range of cooling	Indoor	W.B.	59~75°F (15~24°C)		
	Outdoor	D.B.	23~126°F (-5~52°C)		
Heating capacity (Nominal)	*2	BTU/h	323,000		
		kW	94.7		
	(208-230)	Power input	27.30		
		Current input	84.1-76.1		
	(Rated)	BTU/h	304,000		
		kW	89.1		
(208-230)	Power input	25.07	25.47		
	Current input	77.3-69.9	78.5-71.0		
Temp. range of heating	Indoor	D.B.	59~81°F (15~27°C)		
	Outdoor	W.B.	-13~60°F (-25~15.5°C)		
Indoor unit connectable	Total capacity	50~150% of outdoor unit capacity			
	Model/Quantity	P04~P96/2~50			
Sound power level (measured in anechoic room) *3	dB <A>	88.5/88.5			
Refrigerant piping diameter	High pressure	in. (mm)	1-1/8 (28.58) Brazed		
	Low pressure	in. (mm)	1-3/8 (34.93) Brazed		

Set Model			PURY-EP144TNU-A (-BS)		PURY-EP144TNU-A (-BS)	
Model			PURY-EP144TNU-A (-BS)		PURY-EP144TNU-A (-BS)	
Minimum Circuit Ampacity	A		60-60		60-60	
Maximum Overcurrent Protection	A		100-100		100-100	
FAN	Type x Quantity	Propeller fan x 2		Propeller fan x 2		
	Airflow rate	cfm	9,550		9,550	
		m ³ /min	270		270	
		L/s	4,500		4,500	
	Control, Driving mechanism	Inverter-control, Brushless DC motor		Inverter-control, Brushless DC motor		
	Motor output	kW	0.46+0.46		0.46+0.46	
External static press.	0 in.WG (0 Pa)		0 in.WG (0 Pa)			
Compressor	Type x Quantity	Inverter scroll hermetic compressor x 1		Inverter scroll hermetic compressor x 1		
	Starting method	Inverter		Inverter		
	Motor output	kW	9.8		9.8	
	Case heater	kW	-		-	
	Lubricant	MEL32		MEL32		
External finish	Pre-coated galvanized steel sheet (+powder coating for -BS type)		Pre-coated galvanized steel sheet (+powder coating for -BS type)			
External dimension H x W x D	in.	71-5/8 x 48-7/8 x 29-3/16		71-5/8 x 48-7/8 x 29-3/16		
	mm	1,818 x 1,240 x 740		1,818 x 1,240 x 740		
Protection devices	High pressure protection	High pressure sensor, High pressure switch at 4.15 MPa (601 psi)		High pressure sensor, High pressure switch at 4.15 MPa (601 psi)		
	Inverter circuit (COMP./FAN)	Over-heat protection, Over-current protection		Over-heat protection, Over-current protection		
	Fan motor	-		-		
Refrigerant	Type x original charge	R410A x 23 lbs + 12 oz (10.8 kg)		R410A x 23 lbs + 12 oz (10.8 kg)		
	Control	Indoor LEV and BC controller				
Net weight	lbs (kg)	680 (308)		680 (308)		
Heat exchanger	Salt-resistant cross fin & aluminium tube		Salt-resistant cross fin & aluminium tube			
HIC circuit (HIC: Heat Inter-Changer)	-		-			
Pipe between unit and distributor	High pressure	in. (mm)	7/8 (22.2) Brazed		7/8 (22.2) Brazed	
	Low pressure	in. (mm)	1-1/8 (28.58) Brazed		1-1/8 (28.58) Brazed	
Defrosting method	Auto-defrost mode (Reversed refrigerant cycle)					
Drawing	External	KL94R879				
	Wiring	KE94G655		KE94G655		
Standard attachment	Document	Installation Manual				
	Accessory	Details refer to External Drw				
Optional parts	Outdoor Twinning kit: CMY-R300NCBK joint: CMY-Y102SS-G2, CMY-Y102LS-G2, CMY-R160-J1 Main BC controller: CMB-P108, 1012, 1016NU-JA1, CMB-P1016NU-KA1 Sub BC controller: CMB-P104, 108NU-KB1					
Remarks	Details on foundation work, duct work, insulation work, electrical wiring, power source switch, and other items shall be referred to the Installation Manual.					

Notes:	Unit converter
1.Nominal cooling conditions (Test conditions are based on AHRI 1230) Indoor: 80°F D.B./67°F W.B. (26.7°C D.B./19.4°C W.B.), Outdoor: 95°F D.B. (35°C D.B.)	BTU/h = kW x 3,412
2.Nominal heating conditions (Test conditions are based on AHRI 1230) Indoor: 70°F D.B. (21.1°C D.B.), Outdoor: 47°F D.B./43°F W.B. (8.3°C D.B./6.1°C W.B.)	cfm = m ³ /min x 35.31
3.Cooling mode/Heating mode	lbs = kg/0.4536
4.External static pressure option is available (0.12 in.WG, 0.24 in.WG, 0.32 in.WG/30 Pa, 60 Pa, 80 Pa).	
* Due to continuing improvement, above specifications may be subject to change without notice.	*Above specification data is subject to rounding variation.

1. SPECIFICATIONS

R2-Series (High efficiency)

PURY-EP-T(S)NU-A, Y(S)NU-A

Outdoor Model			PURY-EP312TSNU-A (-BS)	
Indoor Model			Non-Ducted	Ducted
Power source			3-phase 3-wire 208-230 V ±10% 60 Hz	
Cooling capacity (Nominal)	*1	BTU/h	312,000	
		kW	91.4	
	(208-230)	Power input	27.98	
		Current input	86.2-78.0	
	(Rated)	BTU/h	296,000	
		kW	86.8	
(208-230)	Power input	26.11	25.18	
	Current input	80.5-72.8	77.6-70.2	
Temp. range of cooling	Indoor	W.B.	59~75°F (15~24°C)	
	Outdoor	D.B.	23~126°F (-5~52°C)	
Heating capacity (Nominal)	*2	BTU/h	350,000	
		kW	102.6	
	(208-230)	Power input	30.53	
		Current input	94.1-85.1	
	(Rated)	BTU/h	334,000	
		kW	97.9	
(208-230)	Power input	28.32	28.21	
	Current input	87.3-78.9	87.0-78.6	
Temp. range of heating	Indoor	D.B.	59~81°F (15~27°C)	
	Outdoor	W.B.	-13~60°F (-25~15.5°C)	
Indoor unit connectable	Total capacity	50~150% of outdoor unit capacity		
	Model/Quantity	P04-P96/2-50		
Sound power level (measured in anechoic room) *3		dB <A>	87.0/88.5	
Refrigerant piping diameter	High pressure	in. (mm)	1-1/8 (28.58) Brazed	
	Low pressure	in. (mm)	1-5/8 (41.28) Brazed	

Set Model			PURY-EP168TNU-A (-BS)		PURY-EP144TNU-A (-BS)	
Model			PURY-EP168TNU-A (-BS)		PURY-EP144TNU-A (-BS)	
Minimum Circuit Ampacity		A	70-70		60-60	
Maximum Overcurrent Protection		A	110-110		100-100	
FAN	Type x Quantity		Propeller fan x 2		Propeller fan x 2	
	Airflow rate	cfm	14,850		9,550	
		m ³ /min	420		270	
		L/s	7,000		4,500	
	Control, Driving mechanism		Inverter-control, Brushless DC motor		Inverter-control, Brushless DC motor	
	Motor output	kW	0.92+0.92		0.46+0.46	
*4 External static press.			0 in.WG (0 Pa)		0 in.WG (0 Pa)	
Compressor	Type x Quantity		Inverter scroll hermetic compressor x 1		Inverter scroll hermetic compressor x 1	
	Starting method		Inverter		Inverter	
	Motor output	kW	12.2		9.8	
	Case heater	kW	-		-	
	Lubricant		MEL32		MEL32	
External finish			Pre-coated galvanized steel sheet (+powder coating for -BS type) <MUNSELL 5Y 8/1>		Pre-coated galvanized steel sheet (+powder coating for -BS type) <MUNSELL 5Y 8/1>	
External dimension H x W x D		in.	71-5/8 x 68-15/16 x 29-3/16		71-5/8 x 48-7/8 x 29-3/16	
		mm	1,818 x 1,750 x 740		1,818 x 1,240 x 740	
Protection devices	High pressure protection		High pressure sensor, High pressure switch at 4.15 MPa (601 psi)		High pressure sensor, High pressure switch at 4.15 MPa (601 psi)	
	Inverter circuit (COMP./FAN)		Over-heat protection, Over-current protection		Over-heat protection, Over-current protection	
	Fan motor		-		-	
Refrigerant	Type x original charge		R410A x 23 lbs + 12 oz (10.8 kg)		R410A x 23 lbs + 12 oz (10.8 kg)	
	Control		Indoor LEV and BC controller			
Net weight		lbs (kg)	777 (352)		680 (308)	
Heat exchanger			Salt-resistant cross fin & aluminium tube		Salt-resistant cross fin & aluminium tube	
HIC circuit (HIC: Heat Inter-Changer)			-			
Pipe between unit and distributor	High pressure	in. (mm)	7/8 (22.2) Brazed		7/8 (22.2) Brazed	
	Low pressure	in. (mm)	1-1/8 (28.58) Brazed		1-1/8 (28.58) Brazed	
Defrosting method			Auto-defrost mode (Reversed refrigerant cycle)			
Drawing	External		KL94R880			
	Wiring		KE94G654		KE94G655	
Standard attachment	Document		Installation Manual			
	Accessory		Details refer to External Drw			
Optional parts			Outdoor Twinning kit: CMY-R300NCBK joint: CMY-Y102SS-G2,CMY-Y102LS-G2,CMY-R160-J1 Main BC controller: CMB-P108,1012,1016NU-JA1,CMB-P1016NU-KA1 Sub BC controller: CMB-P104,108NU-KB1			
Remarks			Details on foundation work, duct work, insulation work, electrical wiring, power source switch, and other items shall be referred to the Installation Manual.			

Notes:	Unit converter
1.Nominal cooling conditions (Test conditions are based on AHRI 1230) Indoor: 80°F D.B./67°F W.B. (26.7°C D.B./19.4°C W.B.), Outdoor: 95°F D.B. (35°C D.B.)	BTU/h =kW x 3,412
2.Nominal heating conditions (Test conditions are based on AHRI 1230) Indoor: 70°F D.B. (21.1°C D.B.), Outdoor: 47°F D.B./43°F W.B. (8.3°C D.B./6.1°C W.B.)	cfm =m ³ /min x 35.31
3.Cooling mode/Heating mode	lbs =kg/0.4536
4.External static pressure option is available (0.12 in.WG, 0.24 in.WG, 0.32 in.WG/30 Pa, 60 Pa, 80 Pa).	
* Due to continuing improvement, above specifications may be subject to change without notice.	*Above specification data is subject to rounding variation.

1. SPECIFICATIONS

R2-Series (High efficiency)

PURY-EP-T(S)NU-A, Y(S)NU-A

Outdoor Model			PURY-EP336TSNU-A (-BS)		
Indoor Model			Non-Ducted		Ducted
Power source			3-phase 3-wire 208-230 V ±10% 60 Hz		
Cooling capacity (Nominal)	*1	BTU/h	336,000		
		kW	98.5		
	(208-230)	Power input	31.43		
		Current input	96.9-87.6		
	(Rated)	BTU/h	320,000		
		kW	93.8		
	(208-230)	Power input	30.12	28.08	
		Current input	92.8-84.0	86.6-78.3	
Temp. range of cooling	Indoor	W.B.	59~75°F (15~24°C)		
	Outdoor	D.B.	23~126°F (-5~52°C)		
Heating capacity (Nominal)	*2	BTU/h	378,000		
		kW	110.8		
	(208-230)	Power input	33.55		
		Current input	103.4-93.5		
	(Rated)	BTU/h	360,000		
		kW	105.5		
	(208-230)	Power input	31.29	30.63	
		Current input	96.5-87.2	94.4-85.4	
Temp. range of heating	Indoor	D.B.	59~81°F (15~27°C)		
	Outdoor	W.B.	-13~60°F (-25~15.5°C)		
Indoor unit connectable	Total capacity	50~150% of outdoor unit capacity			
	Model/Quantity	P04~P96/2~50			
Sound power level (measured in anechoic room) *3	dB <A>	84.5/88.5			
Refrigerant piping diameter	High pressure	in. (mm)	1-1/8 (28.58) Brazed		
	Low pressure	in. (mm)	1-5/8 (41.28) Brazed		

Set Model			PURY-EP168TNU-A (-BS)		PURY-EP168TNU-A (-BS)	
Model			PURY-EP168TNU-A (-BS)		PURY-EP168TNU-A (-BS)	
Minimum Circuit Ampacity	A		70-70		70-70	
Maximum Overcurrent Protection	A		110-110		110-110	
FAN	Type x Quantity	Propeller fan x 2		Propeller fan x 2		
	Airflow rate	cfm	14,850		14,850	
		m ³ /min	420		420	
		L/s	7,000		7,000	
	Control, Driving mechanism	Inverter-control, Brushless DC motor		Inverter-control, Brushless DC motor		
	Motor output	kW	0.92+0.92		0.92+0.92	
External static press.	0 in.WG (0 Pa)		0 in.WG (0 Pa)			
Compressor	Type x Quantity	Inverter scroll hermetic compressor x 1		Inverter scroll hermetic compressor x 1		
	Starting method	Inverter		Inverter		
	Motor output	kW	12.2		12.2	
	Case heater	kW	-		-	
	Lubricant	MEL32		MEL32		
External finish	Pre-coated galvanized steel sheet (+powder coating for -BS type) <MUNSELL 5Y 8/1>		Pre-coated galvanized steel sheet (+powder coating for -BS type) <MUNSELL 5Y 8/1>			
External dimension H x W x D	in.	71-5/8 x 68-15/16 x 29-3/16		71-5/8 x 68-15/16 x 29-3/16		
	mm	1,818 x 1,750 x 740		1,818 x 1,750 x 740		
Protection devices	High pressure protection	High pressure sensor, High pressure switch at 4.15 MPa (601 psi)		High pressure sensor, High pressure switch at 4.15 MPa (601 psi)		
	Inverter circuit (COMP./FAN)	Over-heat protection, Over-current protection		Over-heat protection, Over-current protection		
	Fan motor	-		-		
Refrigerant	Type x original charge	R410A x 23 lbs + 12 oz (10.8 kg)		R410A x 23 lbs + 12 oz (10.8 kg)		
	Control	Indoor LEV and BC controller				
Net weight	lbs (kg)	777 (352)		777 (352)		
Heat exchanger	Salt-resistant cross fin & aluminium tube		Salt-resistant cross fin & aluminium tube			
HIC circuit (HIC: Heat Inter-Changer)	-		-			
Pipe between unit and distributor	High pressure	in. (mm)	7/8 (22.2) Brazed		7/8 (22.2) Brazed	
	Low pressure	in. (mm)	1-1/8 (28.58) Brazed		1-1/8 (28.58) Brazed	
Defrosting method	Auto-defrost mode (Reversed refrigerant cycle)					
Drawing	External	KL94R881				
	Wiring	KE94G654		KE94G654		
Standard attachment	Document	Installation Manual				
	Accessory	Details refer to External Drw				
Optional parts	Outdoor Twinning kit: CMY-R300NCBK joint: CMY-Y102SS-G2, CMY-Y102LS-G2, CMY-R160-J1 Main BC controller: CMB-P108, 1012, 1016NU-JA1, CMB-P1016NU-KA1 Sub BC controller: CMB-P104, 108NU-KB1					
Remarks	Details on foundation work, duct work, insulation work, electrical wiring, power source switch, and other items shall be referred to the Installation Manual.					

Notes:	Unit converter
1. Nominal cooling conditions (Test conditions are based on AHRI 1230) Indoor: 80°F D.B./67°F W.B. (26.7°C D.B./19.4°C W.B.), Outdoor: 95°F D.B. (35°C D.B.)	BTU/h = kW x 3,412
2. Nominal heating conditions (Test conditions are based on AHRI 1230) Indoor: 70°F D.B. (21.1°C D.B.), Outdoor: 47°F D.B./43°F W.B. (8.3°C D.B./6.1°C W.B.)	cfm = m ³ /min x 35.31
3. Cooling mode/Heating mode	lbs = kg/0.4536
4. External static pressure option is available (0.12 in.WG, 0.24 in.WG, 0.32 in.WG/30 Pa, 60 Pa, 80 Pa).	
* Due to continuing improvement, above specifications may be subject to change without notice.	*Above specification data is subject to rounding variation.

1. SPECIFICATIONS

R2-Series (High efficiency)

PURY-EP-T(S)NU-A, Y(S)NU-A

Outdoor Model			PURY-EP384TSNU-A (-BS)		
Indoor Model			Non-Ducted	Ducted	
Power source			3-phase 3-wire 208-230 V ±10% 60 Hz		
Cooling capacity (Nominal)	*1	BTU/h	384,000		
		kW	112.5		
	(208-230)	Power input	36.62		
		Current input	112.9-102.1		
	(Rated)	BTU/h	364,000		
		kW	106.7		
(208-230)	Power input	34.40	32.73		
	Current input	106.0-95.9	100.9-91.2		
Temp. range of cooling	Indoor	W.B.	59~75°F (15~24°C)		
	Outdoor	D.B.	23~126°F (-5~52°C)		
Heating capacity (Nominal)	*2	BTU/h	430,000		
		kW	126.0		
	(208-230)	Power input	38.66		
		Current input	119.2-107.8		
	(Rated)	BTU/h	410,000		
		kW	120.2		
(208-230)	Power input	36.47	35.13		
	Current input	112.4-101.7	108.3-97.9		
Temp. range of heating	Indoor	D.B.	59~81°F (15~27°C)		
	Outdoor	W.B.	-13~60°F (-25~15.5°C)		
Indoor unit connectable	Total capacity		50~150% of outdoor unit capacity		
	Model/Quantity		P04~P96/2~50		
Sound power level (measured in anechoic room) *3		dB <A>	86.5/89.0		
Refrigerant piping diameter	High pressure	in. (mm)	1-1/8 (28.58) Brazed		
	Low pressure	in. (mm)	1-5/8 (41.28) Brazed		

Set Model			PURY-EP192TNU-A(-BS)		PURY-EP192TNU-A(-BS)	
Minimum Circuit Ampacity		A	80-75		80-75	
Maximum Overcurrent Protection		A	125-125		125-125	
FAN	Type x Quantity		Propeller fan x 2		Propeller fan x 2	
	Airflow rate	cfm	13,050		13,050	
		m ³ /min	370		370	
		L/s	6,170		6,170	
	Control, Driving mechanism		Inverter-control, Brushless DC motor		Inverter-control, Brushless DC motor	
	Motor output	kW	0.92+0.92		0.92+0.92	
External static press.		0 in.WG (0 Pa)		0 in.WG (0 Pa)		
Compressor	Type x Quantity		Inverter scroll hermetic compressor x 1		Inverter scroll hermetic compressor x 1	
	Starting method		Inverter		Inverter	
	Motor output	kW	13.2		13.2	
	Case heater	kW	-		-	
	Lubricant		MEL32		MEL32	
External finish			Pre-coated galvanized steel sheet (+powder coating for -BS type) <MUNSELL 5Y 8/1>		Pre-coated galvanized steel sheet (+powder coating for -BS type) <MUNSELL 5Y 8/1>	
External dimension H x W x D		in.	71-5/8 x 68-15/16 x 29-3/16		71-5/8 x 68-15/16 x 29-3/16	
		mm	1,818 x 1,750 x 740		1,818 x 1,750 x 740	
Protection devices	High pressure protection		High pressure sensor, High pressure switch at 4.15 MPa (601 psi)		High pressure sensor, High pressure switch at 4.15 MPa (601 psi)	
	Inverter circuit (COMP./FAN)		Over-current protection		Over-current protection	
	Fan motor		-		-	
Refrigerant	Type x original charge		R410A x 26 lbs + 1 oz (11.8 kg)		R410A x 26 lbs + 1 oz (11.8 kg)	
	Control		Indoor LEV and BC controller			
Net weight		lbs (kg)	887 (402)		887 (402)	
Heat exchanger			Salt-resistant cross fin & aluminium tube		Salt-resistant cross fin & aluminium tube	
HIC circuit (HIC: Heat Inter-Changer)			-			
Pipe between unit and distributor	High pressure	in. (mm)	7/8 (22.2) Brazed		7/8 (22.2) Brazed	
	Low pressure	in. (mm)	1-1/8 (28.58) Brazed		1-1/8 (28.58) Brazed	
Defrosting method			Auto-defrost mode (Reversed refrigerant cycle)			
Drawing	External		KB94C1J5			
	Wiring		KE94G984		KE94G984	
Standard attachment	Document		Installation Manual			
	Accessory		Details refer to External Drw			
Optional parts			Outdoor Twinning kit: CMY-R300NCBK joint: CMY-Y102SS-G2,CMY-Y102LS-G2,CMY-R160-J1 Main BC controller: CMB-P1016NU-KA1 Sub BC controller: CMB-P104,108NU-KB1			
Remarks			Details on foundation work, duct work, insulation work, electrical wiring, power source switch, and other items shall be referred to the Installation Manual.			

Notes:	Unit converter
1.Nominal cooling conditions (Test conditions are based on AHRI 1230) Indoor: 80°F D.B./67°F W.B. (26.7°C D.B./19.4°C W.B.), Outdoor: 95°F D.B. (35°C D.B.)	BTU/h =kW x 3,412
2.Nominal heating conditions (Test conditions are based on AHRI 1230) Indoor: 70°F D.B. (21.1°C D.B.), Outdoor: 47°F D.B./43°F W.B. (8.3°C D.B./6.1°C W.B.)	cfm =m ³ /min x 35.31
3.Cooling mode/Heating mode	lbs =kg/0.4536
4.External static pressure option is available (0.12 in.WG, 0.24 in.WG, 0.32 in.WG/30 Pa, 60 Pa, 80 Pa).	
* Due to continuing improvement, above specifications may be subject to change without notice.	*Above specification data is subject to rounding variation.

1. SPECIFICATIONS

R2-Series (High efficiency)

PURY-EP-T(S)NU-A, Y(S)NU-A

Outdoor Model			PURY-EP432TSNU-A (-BS)		
Indoor Model			Non-Ducted		Ducted
Power source			3-phase 3-wire 208-230 V ±10% 60 Hz		
Cooling capacity (Nominal)	*1	BTU/h	432,000		
		kW	126.6		
	(208-230)	Power input	42.36		
		Current input	130.6-118.1		
	(Rated)	BTU/h	410,000		
		kW	120.2		
	(208-230)	Power input	39.58		38.09
		Current input	122.0-110.3		117.4-106.2
Temp. range of cooling	Indoor	W.B.	59~75°F (15~24°C)		
	Outdoor	D.B.	23~126°F (-5~52°C)		
Heating capacity (Nominal)	*2	BTU/h	480,000		
		kW	140.7		
	(208-230)	Power input	43.14		
		Current input	133.0-120.3		
	(Rated)	BTU/h	455,000		
		kW	133.4		
	(208-230)	Power input	40.70		38.91
		Current input	125.5-113.5		120.0-108.5
Temp. range of heating	Indoor	D.B.	59~81°F (15~27°C)		
	Outdoor	W.B.	-13~60°F (-25~15.5°C)		
Indoor unit connectable	Total capacity	50~150% of outdoor unit capacity			
	Model/Quantity	P04~P96/2~50			
Sound power level (measured in anechoic room) *3	dB <A>	89.0/89.0			
Refrigerant piping diameter	High pressure	in. (mm)	1-1/8 (28.58) Brazed		
	Low pressure	in. (mm)	1-5/8 (41.28) Brazed		

Set Model			PURY-EP216TNU-A(-BS)		PURY-EP216TNU-A(-BS)	
Minimum Circuit Ampacity			A	88-85	88-85	
Maximum Overcurrent Protection			A	150-150	150-150	
FAN	Type x Quantity		Propeller fan x 2		Propeller fan x 2	
	Airflow rate	cfm	14,100		14,100	
		m ³ /min	400		400	
		L/s	6,670		6,670	
	Control, Driving mechanism		Inverter-control, Brushless DC motor		Inverter-control, Brushless DC motor	
	Motor output	kW	0.92+0.92		0.92+0.92	
External static press.			0 in.WG (0 Pa)		0 in.WG (0 Pa)	
Compressor	Type x Quantity		Inverter scroll hermetic compressor x 1		Inverter scroll hermetic compressor x 1	
	Starting method		Inverter		Inverter	
	Motor output	kW	15.8		15.8	
	Case heater	kW	-		-	
	Lubricant		MEL32		MEL32	
External finish			Pre-coated galvanized steel sheet (+powder coating for -BS type) <MUNSELL 5Y 8/1>		Pre-coated galvanized steel sheet (+powder coating for -BS type) <MUNSELL 5Y 8/1>	
External dimension H x W x D			in.	71-5/8 x 68-15/16 x 29-3/16	71-5/8 x 68-15/16 x 29-3/16	
			mm	1,818 x 1,750 x 740	1,818 x 1,750 x 740	
Protection devices	High pressure protection		High pressure sensor, High pressure switch at 4.15 MPa (601 psi)		High pressure sensor, High pressure switch at 4.15 MPa (601 psi)	
	Inverter circuit (COMP./FAN)		Over-current protection		Over-current protection	
	Fan motor		-		-	
Refrigerant	Type x original charge		R410A x 26 lbs + 1 oz (11.8 kg)		R410A x 26 lbs + 1 oz (11.8 kg)	
	Control		Indoor LEV and BC controller			
Net weight			lbs (kg)	887 (402)	887 (402)	
Heat exchanger			Salt-resistant cross fin & aluminium tube		Salt-resistant cross fin & aluminium tube	
HIC circuit (HIC: Heat Inter-Changer)			-			
Pipe between unit and distributor	High pressure	in. (mm)	7/8 (22.2) Brazed		7/8 (22.2) Brazed	
	Low pressure	in. (mm)	1-1/8 (28.58) Brazed		1-1/8 (28.58) Brazed	
Defrosting method			Auto-defrost mode (Reversed refrigerant cycle)			
Drawing	External		KB94C1J5			
	Wiring		KE94G984		KE94G984	
Standard attachment	Document		Installation Manual			
	Accessory		Details refer to External Drw			
Optional parts			Outdoor Twinning kit: CMY-R300NCBK joint: CMY-Y102SS-G2, CMY-Y102LS-G2, CMY-R160-J1 Main BC controller: CMB-P1016NU-KA1 Sub BC controller: CMB-P104, 108NU-KB1			
Remarks			Details on foundation work, duct work, insulation work, electrical wiring, power source switch, and other items shall be referred to the Installation Manual.			

Notes:	Unit converter
1.Nominal cooling conditions (Test conditions are based on AHRI 1230) Indoor: 80°F D.B./67°F W.B. (26.7°C D.B./19.4°C W.B.), Outdoor: 95°F D.B. (35°C D.B.)	BTU/h = kW x 3,412
2.Nominal heating conditions (Test conditions are based on AHRI 1230) Indoor: 70°F D.B. (21.1°C D.B.), Outdoor: 47°F D.B./43°F W.B. (8.3°C D.B./6.1°C W.B.)	cfm = m ³ /min x 35.31
3.Cooling mode/Heating mode	lbs = kg/0.4536
4.External static pressure option is available (0.12 in.WG, 0.24 in.WG, 0.32 in.WG/30 Pa, 60 Pa, 80 Pa).	
* Due to continuing improvement, above specifications may be subject to change without notice.	*Above specification data is subject to rounding variation.

1. SPECIFICATIONS

R2-Series (High efficiency)

PURY-EP-T(S)NU-A, Y(S)NU-A

Outdoor Model			PURY-EP72YNU-A (-BS)		
Indoor Model			Non-Ducted	Ducted	
Power source			3-phase 3-wire 460 V ±10% 60 Hz		
Cooling capacity (Nominal)	*1	BTU/h	72,000		
		kW	21.1		
	(460)	Power input	kW	4.44	
		Current input	A	6.1	
	(Rated)	BTU/h	69,000		
		kW	20.2		
	(460)	Power input	kW	3.96	4.26
		Current input	A	5.5	5.9
Temp. range of cooling	Indoor	W.B.	59~75°F (15~24°C)		
	Outdoor	D.B.	23~126°F (-5~52°C)		
Heating capacity (Nominal)	*2	BTU/h	80,000		
		kW	23.4		
	(460)	Power input	kW	5.43	
		Current input	A	7.5	
	(Rated)	BTU/h	76,000		
		kW	22.3		
	(460)	Power input	kW	4.77	5.28
		Current input	A	6.6	7.3
Temp. range of heating	Indoor	D.B.	59~81°F (15~27°C)		
	Outdoor	W.B.	-13~60°F (-25~15.5°C)		
Indoor unit connectable	Total capacity	50~150% of outdoor unit capacity			
	Model/Quantity	P04~P96/1~18			
Sound power level (measured in anechoic room) *3	dB <A>	75.5/77.0			
Refrigerant piping diameter	High pressure	in. (mm)	5/8 (15.88) Brazed		
	Low pressure	in. (mm)	3/4 (19.05) Brazed		
Minimum Circuit Ampacity	A	14			
Maximum Overcurrent Protection	A	20			
FAN	Type x Quantity	Propeller fan x 1			
	Airflow rate	cfm	6,000		
		m ³ /min	170		
		L/s	2,830		
	Control, Driving mechanism	Inverter-control, Brushless DC motor			
	Motor output	kW	0.92		
*4 External static press.	0 in.WG (0 Pa)				
Compressor	Type x Quantity	Inverter scroll hermetic compressor x 1			
	Starting method	Inverter			
	Motor output	kW	3.8		
	Case heater	kW	-		
	Lubricant	MEL32			
External finish	Pre-coated galvanized steel sheet (+powder coating for -BS type) <MUNSELL 5Y 8/1>				
External dimension H x W x D	in.	71-5/8 x 36-1/4 x 29-3/16			
	mm	1,818 x 920 x 740			
Protection devices	High pressure protection	High pressure sensor, High pressure switch at 4.15 MPa (601 psi)			
	Inverter circuit (COMP./FAN)	Over-heat protection, Over-current protection			
	Fan motor	-			
Refrigerant	Type x original charge	R410A x 11 lbs + 7 oz (5.2 kg)			
	Control	Indoor LEV and BC controller			
Net weight	lbs (kg)	552 (250)			
Heat exchanger	Salt-resistant cross fin & aluminium tube				
HIC circuit (HIC: Heat Inter-Changer)	-				
Defrosting method	Auto-defrost mode (Reversed refrigerant cycle)				
Drawing	External	KL94R882			
	Wiring	KE94G653			
Standard attachment	Document	Installation Manual			
	Accessory	Details refer to External Drw			
Optional parts	joint: CMY-Y102SS-G2, CMY-Y102LS-G2, CMY-R160-J1 BC controller: CMB-P104,106,108,1012,1016NU-J1 Main BC controller: CMB-P108,1012,1016NU-JA1,CMB-P1016NU-KA1 Sub BC controller: CMB-P104,108NU-KB1				
Remarks	Details on foundation work, duct work, insulation work, electrical wiring, power source switch, and other items shall be referred to the Installation Manual.				

Notes:

- Nominal cooling conditions (Test conditions are based on AHRI 1230)
Indoor: 80°F D.B./67°F W.B. (26.7°C D.B./19.4°C W.B.), Outdoor: 95°F D.B. (35°C D.B.)
- Nominal heating conditions (Test conditions are based on AHRI 1230)
Indoor: 70°F D.B. (21.1°C D.B.), Outdoor: 47°F D.B./43°F W.B. (8.3°C D.B./6.1°C W.B.)
- Cooling mode/Heating mode
- External static pressure option is available (0.12 in.WG, 0.24 in.WG, 0.32 in.WG/30 Pa, 60 Pa, 80 Pa).

Unit converter	
BTU/h	=kW x 3,412
cfm	=m ³ /min x 35.31
lbs	=kg/0.4536
*Above specification data is subject to rounding variation.	

* Due to continuing improvement, above specifications may be subject to change without notice.

1. SPECIFICATIONS

R2-Series (High efficiency)

PURY-EP-T(S)NU-A, Y(S)NU-A

Outdoor Model			PURY-EP96YNU-A (-BS)		
Indoor Model			Non-Ducted	Ducted	
Power source			3-phase 3-wire 460 V ±10% 60 Hz		
Cooling capacity (Nominal)	*1	BTU/h	96,000		
		kW	28.1		
	(460)	Power input	6.11		
		Current input	8.5		
	(Rated)	BTU/h	92,000		
		kW	27.0		
	(460)	Power input	5.55	5.76	
		Current input	7.7	8.0	
Temp. range of cooling	Indoor	W.B.	59~75°F (15~24°C)		
	Outdoor	D.B.	23~126°F (-5~52°C)		
Heating capacity (Nominal)	*2	BTU/h	108,000		
		kW	31.7		
	(460)	Power input	7.40		
		Current input	10.3		
	(Rated)	BTU/h	103,000		
		kW	30.2		
	(460)	Power input	6.72	6.98	
		Current input	9.3	9.7	
Temp. range of heating	Indoor	D.B.	59~81°F (15~27°C)		
	Outdoor	W.B.	-13~60°F (-25~15.5°C)		
Indoor unit connectable	Total capacity	50~150% of outdoor unit capacity			
	Model/Quantity	P04~P96/1~24			
Sound power level (measured in anechoic room) *3		dB <A>	77.5/79.0		
Refrigerant piping diameter	High pressure	in. (mm)	3/4 (19.05) Brazed		
	Low pressure	in. (mm)	7/8 (22.2) Brazed		
Minimum Circuit Ampacity		A	20		
Maximum Overcurrent Protection		A	30		
FAN	Type x Quantity		Propeller fan x 2		
	Airflow rate	cfm	7,400		
		m ³ /min	210		
		L/s	3,500		
	Control, Driving mechanism		Inverter-control, Brushless DC motor		
	*4 Motor output		kW	0.46+0.46	
External static press.		0 in.WG (0 Pa)			
Compressor	Type x Quantity		Inverter scroll hermetic compressor x 1		
	Starting method		Inverter		
	Motor output		kW	5.5	
	Case heater		kW	-	
	Lubricant		MEL32		
External finish		Pre-coated galvanized steel sheet (+powder coating for -BS type) <MUNSELL 5Y 8/1>			
External dimension H x W x D		in.	71-5/8 x 48-7/8 x 29-3/16		
		mm	1,818 x 1,240 x 740		
Protection devices	High pressure protection		High pressure sensor, High pressure switch at 4.15 MPa (601 psi)		
	Inverter circuit (COMP./FAN)		Over-heat protection, Over-current protection		
	Fan motor		-		
Refrigerant	Type x original charge		R410A x 17 lbs + 10 oz (8.0 kg)		
	Control		Indoor LEV and BC controller		
Net weight		lbs (kg)	649 (294)		
Heat exchanger		Salt-resistant cross fin & aluminium tube			
HIC circuit (HIC: Heat Inter-Changer)		-			
Defrosting method		Auto-defrost mode (Reversed refrigerant cycle)			
Drawing	External		KL94R883		
	Wiring		KE94G652		
Standard attachment	Document		Installation Manual		
	Accessory		Details refer to External Drw		
Optional parts		joint: CMY-Y102SS-G2, CMY-Y102LS-G2, CMY-R160-J1 BC controller: CMB-P104, 106, 108, 1012, 1016NU-J1 Main BC controller: CMB-P108, 1012, 1016NU-JA1, CMB-P1016NU-KA1 Sub BC controller: CMB-P104, 108NU-KB1			
Remarks		Details on foundation work, duct work, insulation work, electrical wiring, power source switch, and other items shall be referred to the Installation Manual.			

Notes:	1.Nominal cooling conditions (Test conditions are based on AHRI 1230) Indoor: 80°F D.B./67°F W.B. (26.7°C D.B./19.4°C W.B.), Outdoor: 95°F D.B. (35°C D.B.)	Unit converter BTU/h =kW x 3.412 cfm =m ³ /min x 35.31 lbs =kg/0.4536
	2.Nominal heating conditions (Test conditions are based on AHRI 1230) Indoor: 70°F D.B. (21.1°C D.B.), Outdoor: 47°F D.B./43°F W.B. (8.3°C D.B./6.1°C W.B.)	
	3.Cooling mode/Heating mode	
	4.External static pressure option is available (0.12 in.WG, 0.24 in.WG, 0.32 in.WG/30 Pa, 60 Pa, 80 Pa).	
* Due to continuing improvement, above specifications may be subject to change without notice.		*Above specification data is subject to rounding variation.

1. SPECIFICATIONS

R2-Series (High efficiency)

PURY-EP-T(S)NU-A, Y(S)NU-A

Outdoor Model		PURY-EP120YNU-A (-BS)		
Indoor Model		Non-Ducted	Ducted	
Power source		3-phase 3-wire 460 V ±10% 60 Hz		
Cooling capacity (Nominal)	*1	BTU/h	120,000	
		kW	35.2	
	(460)	Power input	kW	8.43
		Current input	A	11.7
	(Rated)		BTU/h	114,000
			kW	33.4
(460)	Power input	kW	7.70	
	Current input	A	10.7	
Temp. range of cooling	Indoor	W.B.	59~75°F (15~24°C)	
	Outdoor	D.B.	23~126°F (-5~52°C)	
Heating capacity (Nominal)	*2	BTU/h	135,000	
		kW	39.6	
	(460)	Power input	kW	9.89
		Current input	A	13.7
	(Rated)		BTU/h	129,000
			kW	37.8
(460)	Power input	kW	8.95	
	Current input	A	12.4	
Temp. range of heating	Indoor	D.B.	59~81°F (15~27°C)	
	Outdoor	W.B.	-13~60°F (-25~15.5°C)	
Indoor unit connectable	Total capacity	50~150% of outdoor unit capacity		
	Model/Quantity	P04~P96/1~30		
Sound power level (measured in anechoic room) *3	dB <A>	80.5/80.5		
Refrigerant piping diameter	High pressure	in. (mm)	3/4 (19.05) Brazed	
	Low pressure	in. (mm)	1-1/8 (28.58) Brazed	
Minimum Circuit Ampacity	A	26		
Maximum Overcurrent Protection	A	40		
FAN	Type x Quantity	Propeller fan x 2		
	Airflow rate	cfm	8,300	
		m ³ /min	235	
		L/s	3,920	
	Control, Driving mechanism	Inverter-control, Brushless DC motor		
	Motor output	kW	0.46+0.46	
*4 External static press.	0 in.WG (0 Pa)			
Compressor	Type x Quantity	Inverter scroll hermetic compressor x 1		
	Starting method	Inverter		
	Motor output	kW	7.6	
	Case heater	kW	-	
	Lubricant	MEL32		
External finish	Pre-coated galvanized steel sheet (+powder coating for -BS type) <MUNSELL 5Y 8/1>			
External dimension H x W x D	in.	71-5/8 x 48-7/8 x 29-3/16		
	mm	1,818 x 1,240 x 740		
Protection devices	High pressure protection	High pressure sensor, High pressure switch at 4.15 MPa (601 psi)		
	Inverter circuit (COMP./FAN)	Over-heat protection, Over-current protection		
	Fan motor	-		
Refrigerant	Type x original charge	R410A x 17 lbs + 10 oz (8.0 kg)		
	Control	Indoor LEV and BC controller		
Net weight	lbs (kg)	657 (298)		
Heat exchanger	Salt-resistant cross fin & aluminium tube			
HIC circuit (HIC: Heat Inter-Changer)	-			
Defrosting method	Auto-defrost mode (Reversed refrigerant cycle)			
Drawing	External	KL94R883		
	Wiring	KE94G652		
Standard attachment	Document	Installation Manual		
	Accessory	Details refer to External Drw		
Optional parts	joint: CMY-Y102SS-G2, CMY-Y102LS-G2, CMY-R160-J1 BC controller: CMB-P104, 106, 108, 1012, 1016NU-J1 Main BC controller: CMB-P108, 1012, 1016NU-JA1, CMB-P1016NU-KA1 Sub BC controller: CMB-P104, 108NU-KB1			
Remarks	Details on foundation work, duct work, insulation work, electrical wiring, power source switch, and other items shall be referred to the Installation Manual.			

Notes:

- Nominal cooling conditions (Test conditions are based on AHRI 1230)
Indoor: 80°F D.B./67°F W.B. (26.7°C D.B./19.4°C W.B.), Outdoor: 95°F D.B. (35°C D.B.)
- Nominal heating conditions (Test conditions are based on AHRI 1230)
Indoor: 70°F D.B. (21.1°C D.B.), Outdoor: 47°F D.B./43°F W.B. (8.3°C D.B./6.1°C W.B.)
- Cooling mode/Heating mode
- External static pressure option is available (0.12 in.WG, 0.24 in.WG, 0.32 in.WG/30 Pa, 60 Pa, 80 Pa).

Unit converter	
BTU/h	=kW x 3,412
cfm	=m ³ /min x 35.31
lbs	=kg/0.4536
*Above specification data is subject to rounding variation.	

* Due to continuing improvement, above specifications may be subject to change without notice.

1. SPECIFICATIONS

R2-Series (High efficiency)

PURY-EP-T(S)NU-A, Y(S)NU-A

Outdoor Model			PURY-EP144YNU-A (-BS)		
Indoor Model			Non-Ducted		Ducted
Power source			3-phase 3-wire 460 V ±10% 60 Hz		
Cooling capacity (Nominal)	*1	BTU/h	144,000		
		kW	42.2		
	(460)	Power input	11.03		
		Current input	15.3		
	(Rated)	BTU/h	137,000		
		kW	40.2		
	(460)	Power input	10.04	10.38	
		Current input	14.0	14.4	
Temp. range of cooling	Indoor	W.B.	59~75°F (15~24°C)		
	Outdoor	D.B.	23~126°F (-5~52°C)		
Heating capacity (Nominal)	*2	BTU/h	160,000		
		kW	46.9		
	(460)	Power input	12.34		
		Current input	17.2		
	(Rated)	BTU/h	152,000		
		kW	44.5		
	(460)	Power input	11.08	11.76	
		Current input	15.4	16.4	
Temp. range of heating	Indoor	D.B.	59~81°F (15~27°C)		
	Outdoor	W.B.	-13~60°F (-25~15.5°C)		
Indoor unit connectable	Total capacity	50~150% of outdoor unit capacity			
	Model/Quantity	P04~P96/1~36			
Sound power level (measured in anechoic room) *3		dB <A>	85.5/85.5		
Refrigerant piping diameter	High pressure	in. (mm)	7/8 (22.2) Brazed		
	Low pressure	in. (mm)	1-1/8 (28.58) Brazed		
Minimum Circuit Ampacity		A	34		
Maximum Overcurrent Protection		A	50		
FAN	Type x Quantity		Propeller fan x 2		
	Airflow rate	cfm	9,550		
		m ³ /min	270		
		L/s	4,500		
	Control, Driving mechanism		Inverter-control, Brushless DC motor		
	Motor output	kW	0.46+0.46		
*4 External static press.	0 in.WG (0 Pa)				
Compressor	Type x Quantity		Inverter scroll hermetic compressor x 1		
	Starting method		Inverter		
	Motor output	kW	9.8		
	Case heater	kW	-		
	Lubricant		MEL32		
External finish			Pre-coated galvanized steel sheet (+powder coating for -BS type) <MUNSELL 5Y 8/1>		
External dimension H x W x D		in.	71-5/8 x 48-7/8 x 29-3/16		
		mm	1,818 x 1,240 x 740		
Protection devices	High pressure protection		High pressure sensor, High pressure switch at 4.15 MPa (601 psi)		
	Inverter circuit (COMP./FAN)		Over-heat protection, Over-current protection		
	Fan motor		-		
Refrigerant	Type x original charge		R410A x 23 lbs + 12 oz (10.8 kg)		
	Control		Indoor LEV and BC controller		
Net weight		lbs (kg)	715 (324)		
Heat exchanger			Salt-resistant cross fin & aluminium tube		
HIC circuit (HIC: Heat Inter-Changer)			-		
Defrosting method			Auto-defrost mode (Reversed refrigerant cycle)		
Drawing	External		KL94R883		
	Wiring		KE94G652		
Standard attachment	Document		Installation Manual		
	Accessory		Details refer to External Drw		
Optional parts			joint: CMY-Y102SS-G2, CMY-Y102LS-G2, CMY-R160-J1 Main BC controller: CMB-P108, 1012, 1016NU-JA1, CMB-P1016NU-KA1 Sub BC controller: CMB-P104, 108NU-KB1		
Remarks			Details on foundation work, duct work, insulation work, electrical wiring, power source switch, and other items shall be referred to the Installation Manual.		

Notes:	Unit converter
1.Nominal cooling conditions (Test conditions are based on AHRI 1230) Indoor: 80°F D.B./67°F W.B. (26.7°C D.B./19.4°C W.B.), Outdoor: 95°F D.B. (35°C D.B.)	BTU/h =kW x 3.412
2.Nominal heating conditions (Test conditions are based on AHRI 1230) Indoor: 70°F D.B. (21.1°C D.B.), Outdoor: 47°F D.B./43°F W.B. (8.3°C D.B./6.1°C W.B.)	cfm =m ³ /min x 35.31
3.Cooling mode/Heating mode	lbs =kg/0.4536
4.External static pressure option is available (0.12 in.WG, 0.24 in.WG, 0.32 in.WG/30 Pa, 60 Pa, 80 Pa).	
* Due to continuing improvement, above specifications may be subject to change without notice.	*Above specification data is subject to rounding variation.

1. SPECIFICATIONS

R2-Series (High efficiency)

Outdoor Model			PURY-EP168YNU-A (-BS)		
Indoor Model			Non-Ducted	Ducted	
Power source			3-phase 3-wire 460 V ±10% 60 Hz		
Cooling capacity (Nominal)	*1	BTU/h	168,000		
		kW	49.2		
	(460)	Power input	kW	13.99	
		Current input	A	19.5	
	(Rated)	(460)	BTU/h	161,000	
			kW	47.2	
	(460)	Power input	kW	12.92	12.98
		Current input	A	18.0	18.1
Temp. range of cooling	Indoor	W.B.	59~75°F (15~24°C)		
	Outdoor	D.B.	23~126°F (-5~52°C)		
Heating capacity (Nominal)	*2	BTU/h	188,000		
		kW	55.1		
	(460)	Power input	kW	15.17	
		Current input	A	21.1	
	(Rated)	(460)	BTU/h	179,000	
			kW	52.5	
	(460)	Power input	kW	13.32	14.77
		Current input	A	18.5	20.5
Temp. range of heating	Indoor	D.B.	59~81°F (15~27°C)		
	Outdoor	W.B.	-13~60°F (-25~15.5°C)		
Indoor unit connectable	Total capacity	50~150% of outdoor unit capacity			
	Model/Quantity	P04~P96/1~42			
Sound power level (measured in anechoic room) *3	dB <A>	81.0/85.5			
Refrigerant piping diameter	High pressure	in. (mm)	7/8 (22.2) Brazed		
	Low pressure	in. (mm)	1-1/8 (28.58) Brazed		
Minimum Circuit Ampacity	A	35			
Maximum Overcurrent Protection	A	50			
FAN	Type x Quantity	Propeller fan x 2			
	Airflow rate	cfm	14,850		
		m ³ /min	420		
		L/s	7,000		
	Control, Driving mechanism	Inverter-control, Brushless DC motor			
	Motor output	kW	0.92+0.92		
*4 External static press.	0 in.WG (0 Pa)				
Compressor	Type x Quantity	Inverter scroll hermetic compressor x 1			
	Starting method	Inverter			
	Motor output	kW	12.2		
	Case heater	kW	-		
	Lubricant	MEL32			
External finish	Pre-coated galvanized steel sheet (+powder coating for -BS type) <MUNSELL 5Y 8/1>				
External dimension H x W x D	in.	71-5/8 x 68-15/16 x 29-3/16			
	mm	1,818 x 1,750 x 740			
Protection devices	High pressure protection	High pressure sensor, High pressure switch at 4.15 MPa (601 psi)			
	Inverter circuit (COMP./FAN)	Over-heat protection, Over-current protection			
	Fan motor	-			
Refrigerant	Type x original charge	R410A x 23 lbs + 12 oz (10.8 kg)			
	Control	Indoor LEV and BC controller			
Net weight	lbs (kg)	807 (366)			
Heat exchanger	Salt-resistant cross fin & aluminium tube				
HIC circuit (HIC: Heat Inter-Changer)	-				
Defrosting method	Auto-defrost mode (Reversed refrigerant cycle)				
Drawing	External	KL94R884			
	Wiring	KE94G651			
Standard attachment	Document	Installation Manual			
	Accessory	Details refer to External Drw			
Optional parts	joint: CMY-Y102SS-G2, CMY-Y102LS-G2, CMY-R160-J1 Main BC controller: CMB-P108, 1012, 1016NU-JA1, CMB-P1016NU-KA1 Sub BC controller: CMB-P104, 108NU-KB1				
Remarks	Details on foundation work, duct work, insulation work, electrical wiring, power source switch, and other items shall be referred to the Installation Manual.				

Notes:	Unit converter
1.Nominal cooling conditions (Test conditions are based on AHRI 1230) Indoor: 80°F D.B./67°F W.B. (26.7°C D.B./19.4°C W.B.), Outdoor: 95°F D.B. (35°C D.B.)	BTU/h =kW x 3,412
2.Nominal heating conditions (Test conditions are based on AHRI 1230) Indoor: 70°F D.B. (21.1°C D.B.), Outdoor: 47°F D.B./43°F W.B. (8.3°C D.B./6.1°C W.B.)	cfm =m ³ /min x 35.31
3.Cooling mode/Heating mode	lbs =kg/0.4536
4.External static pressure option is available (0.12 in.WG, 0.24 in.WG, 0.32 in.WG/30 Pa, 60 Pa, 80 Pa).	
* Due to continuing improvement, above specifications may be subject to change without notice.	*Above specification data is subject to rounding variation.

1. SPECIFICATIONS

R2-Series (High efficiency)

PURY-EP-T(S)NU-A, Y(S)NU-A

Outdoor Model			PURY-EP192YNU-A (-BS)		
Indoor Model			Non-Ducted		Ducted
Power source			3-phase 3-wire 460 V ±10% 60 Hz		
Cooling capacity (Nominal)	*1	BTU/h	192,000		
		kW	56.3		
	(460)	Power input	15.65		
		Current input	21.8		
	(Rated)	BTU/h	182,000		
		kW	53.3		
(460)	Power input	14.24	14.45		
	Current input	19.8	20.1		
Temp. range of cooling	Indoor	W.B.	59~75°F (15~24°C)		
	Outdoor	D.B.	23~126°F (-5~52°C)		
Heating capacity (Nominal)	*2	BTU/h	215,000		
		kW	63.0		
	(460)	Power input	17.54		
		Current input	24.4		
	(Rated)	BTU/h	204,000		
		kW	59.8		
(460)	Power input	15.37	16.58		
	Current input	21.4	23.1		
Temp. range of heating	Indoor	D.B.	59~81°F (15~27°C)		
	Outdoor	W.B.	-13~60°F (-25~15.5°C)		
Indoor unit connectable	Total capacity	50~150% of outdoor unit capacity			
	Model/Quantity	P04~P96/1~48			
Sound power level (measured in anechoic room) *3		dB <A>	83.5/85.0		
Refrigerant piping diameter	High pressure	in. (mm)	7/8 (22.2) Brazed		
	Low pressure	in. (mm)	1-1/8 (28.58) Brazed		
Minimum Circuit Ampacity		A	38		
Maximum Overcurrent Protection		A	60		
FAN	Type x Quantity		Propeller fan x 2		
	Airflow rate	cfm	13,050		
		m ³ /min	370		
		L/s	6,170		
	Control, Driving mechanism		Inverter-control, Brushless DC motor		
	Motor output	kW	0.92+0.92		
*4	External static press.		0 in.WG (0 Pa)		
Compressor	Type x Quantity		Inverter scroll hermetic compressor x 1		
	Starting method		Inverter		
	Motor output	kW	13.2		
	Case heater	kW	-		
	Lubricant		MEL32		
External finish			Pre-coated galvanized steel sheet (+powder coating for -BS type) <MUNSELL 5Y 8/1>		
External dimension H x W x D		in.	71-5/8 x 68-15/16 x 29-3/16		
		mm	1,818 x 1,750 x 740		
Protection devices	High pressure protection		High pressure sensor, High pressure switch at 4.15 MPa (601 psi)		
	Inverter circuit (COMP./FAN)		Over-current protection		
	Fan motor		-		
Refrigerant	Type x original charge		R410A x 26 lbs + 1 oz (11.8 kg)		
	Control		Indoor LEV and BC controller		
Net weight		lbs (kg)	918 (416)		
Heat exchanger			Salt-resistant cross fin & aluminium tube		
HIC circuit (HIC: Heat Inter-Changer)			-		
Defrosting method			Auto-defrost mode (Reversed refrigerant cycle)		
Drawing	External		KB94C1J6		
	Wiring		KE94G983		
Standard attachment	Document		Installation Manual		
	Accessory		Details refer to External Drw		
Optional parts			joint: CMY-Y102SS-G2, CMY-Y102LS-G2, CMY-R160-J1 Main BC controller: CMB-P108, 1012, 1016NU-JA1, CMB-P1016NU-KA1 Sub BC controller: CMB-P104, 108NU-KB1		
Remarks			Details on foundation work, duct work, insulation work, electrical wiring, power source switch, and other items shall be referred to the Installation Manual.		

Notes:		Unit converter
1.Nominal cooling conditions (Test conditions are based on AHRI 1230) Indoor: 80°F D.B./67°F W.B. (26.7°C D.B./19.4°C W.B.), Outdoor: 95°F D.B. (35°C D.B.)		BTU/h =kW x 3.412
2.Nominal heating conditions (Test conditions are based on AHRI 1230) Indoor: 70°F D.B. (21.1°C D.B.), Outdoor: 47°F D.B./43°F W.B. (8.3°C D.B./6.1°C W.B.)		cfm =m ³ /min x 35.31
3.Cooling mode/Heating mode		lbs =kg/0.4536
4.External static pressure option is available (0.12 in.WG, 0.24 in.WG, 0.32 in.WG/30 Pa, 60 Pa, 80 Pa).		
* Due to continuing improvement, above specifications may be subject to change without notice.		*Above specification data is subject to rounding variation.

1. SPECIFICATIONS

R2-Series (High efficiency)

PURY-EP-T(S)NU-A, Y(S)NU-A

Outdoor Model			PURY-EP216YNU-A (-BS)		
Indoor Model			Non-Ducted	Ducted	
Power source			3-phase 3-wire 460 V ±10% 60 Hz		
Cooling capacity (Nominal)	*1	BTU/h	216,000		
		kW	63.3		
	(460)	Power input	kW	18.66	
		Current input	A	26.0	
	(Rated)	BTU/h	206,000		
		kW	60.4		
	(460)	Power input	kW	17.43	17.13
		Current input	A	24.3	23.8
Temp. range of cooling	Indoor	W.B.	59~75°F (15~24°C)		
	Outdoor	D.B.	23~126°F (-5~52°C)		
Heating capacity (Nominal)	*2	BTU/h	243,000		
		kW	71.2		
	(460)	Power input	kW	20.43	
		Current input	A	28.4	
	(Rated)	BTU/h	232,000		
		kW	68.0		
	(460)	Power input	kW	18.22	19.61
		Current input	A	25.4	27.3
Temp. range of heating	Indoor	D.B.	59~81°F (15~27°C)		
	Outdoor	W.B.	-13~60°F (-25~15.5°C)		
Indoor unit connectable	Total capacity	50~150% of outdoor unit capacity			
	Model/Quantity	P04~P96/2~50			
Sound power level (measured in anechoic room) *3	dB <A>	86.0/86.5			
Refrigerant piping diameter	High pressure	in. (mm)	7/8 (22.2) Brazed (1-1/8 (28.58) Brazed for the part that exceeds 65 m)		
	Low pressure	in. (mm)	1-3/8 (34.93) Brazed		
Minimum Circuit Ampacity	A	41			
Maximum Overcurrent Protection	A	70			
FAN	Type x Quantity	Propeller fan x 2			
	Airflow rate	cfm	14,100		
		m ³ /min	400		
		L/s	6,670		
	Control, Driving mechanism	Inverter-control, Brushless DC motor			
	Motor output	kW	0.92±0.92		
*4 External static press.	0 in.WG (0 Pa)				
Compressor	Type x Quantity	Inverter scroll hermetic compressor x 1			
	Starting method	Inverter			
	Motor output	kW	15.8		
	Case heater	kW	-		
	Lubricant	MEL32			
External finish	Pre-coated galvanized steel sheet (+powder coating for -BS type) <MUNSELL 5Y 8/1>				
External dimension H x W x D	in.	71-5/8 x 68-15/16 x 29-3/16			
	mm	1,818 x 1,750 x 740			
Protection devices	High pressure protection	High pressure sensor, High pressure switch at 4.15 MPa (601 psi)			
	Inverter circuit (COMP./FAN)	Over-current protection			
	Fan motor	-			
Refrigerant	Type x original charge	R410A x 26 lbs + 1 oz (11.8 kg)			
	Control	Indoor LEV and BC controller			
Net weight	lbs (kg)	918 (416)			
Heat exchanger	Salt-resistant cross fin & aluminium tube				
HIC circuit (HIC: Heat Inter-Changer)	-				
Defrosting method	Auto-defrost mode (Reversed refrigerant cycle)				
Drawing	External	KB94C1J6			
	Wiring	KE94G983			
Standard attachment	Document	Installation Manual			
	Accessory	Details refer to External Drw			
Optional parts	joint: CMY-Y102SS-G2, CMY-Y102LS-G2, CMY-R160-J1 Main BC controller: CMB-P108, 1012, 1016NU-JA1, CMB-P1016NU-KA1 Sub BC controller: CMB-P104, 108NU-KB1				
Remarks	Details on foundation work, duct work, insulation work, electrical wiring, power source switch, and other items shall be referred to the Installation Manual.				

Notes:	Unit converter
1. Nominal cooling conditions (Test conditions are based on AHRI 1230) Indoor: 80°F D.B./67°F W.B. (26.7°C D.B./19.4°C W.B.), Outdoor: 95°F D.B. (35°C D.B.)	BTU/h = kW x 3,412
2. Nominal heating conditions (Test conditions are based on AHRI 1230) Indoor: 70°F D.B. (21.1°C D.B.), Outdoor: 47°F D.B./43°F W.B. (8.3°C D.B./6.1°C W.B.)	cfm = m ³ /min x 35.31
3. Cooling mode/Heating mode	lbs = kg/0.4536
4. External static pressure option is available (0.12 in.WG, 0.24 in.WG, 0.32 in.WG/30 Pa, 60 Pa, 80 Pa).	
* Due to continuing improvement, above specifications may be subject to change without notice.	*Above specification data is subject to rounding variation.

1. SPECIFICATIONS

R2-Series (High efficiency)

PURY-EP-T(S)NU-A, Y(S)NU-A

Outdoor Model			PURY-EP240YNU-A (-BS)		
Indoor Model			Non-Ducted		Ducted
Power source			3-phase 3-wire 460 V ±10% 60 Hz		
Cooling capacity (Nominal)	*1	BTU/h	224,000		
		kW	65.7		
	(460)	Power input	21.39		
		Current input	29.8		
	(Rated)	BTU/h	222,000		
		kW	65.1		
	(460)	Power input	20.20	19.24	
		Current input	28.1	26.8	
Temp. range of cooling	Indoor	W.B.	59~75°F (15~24°C)		
	Outdoor	D.B.	23~126°F (-5~52°C)		
Heating capacity (Nominal)	*2	BTU/h	250,000		
		kW	73.3		
	(460)	Power input	21.79		
		Current input	30.3		
	(Rated)	BTU/h	240,000		
		kW	70.3		
	(460)	Power input	19.96	20.40	
		Current input	27.8	28.4	
Temp. range of heating	Indoor	D.B.	59~81°F (15~27°C)		
	Outdoor	W.B.	-13~60°F (-25~15.5°C)		
Indoor unit connectable	Total capacity	50~150% of outdoor unit capacity			
	Model/Quantity	P04~P96/2~50			
Sound power level (measured in anechoic room) *3		dB <A>	88.0/87.0		
Refrigerant piping diameter	High pressure	in. (mm)	7/8 (22.2) Brazed (1-1/8 (28.58) Brazed for the part that exceeds 65 m)		
	Low pressure	in. (mm)	1-3/8 (34.93) Brazed		
Minimum Circuit Ampacity		A	41		
Maximum Overcurrent Protection		A	70		
FAN	Type x Quantity		Propeller fan x 2		
	Airflow rate	cfm	14,500		
		m ³ /min	410		
		L/s	6,830		
	Control, Driving mechanism		Inverter-control, Brushless DC motor		
	Motor output	kW	0.92+0.92		
*4 External static press.		0 in.WG (0 Pa)			
Compressor	Type x Quantity		Inverter scroll hermetic compressor x 1		
	Starting method		Inverter		
	Motor output	kW	17.0		
	Case heater	kW	-		
	Lubricant		MEL32		
External finish			Pre-coated galvanized steel sheet (+powder coating for -BS type) <MUNSELL 5Y 8/1>		
External dimension H x W x D		in.	71-5/8 x 68-15/16 x 29-3/16		
		mm	1,818 x 1,750 x 740		
Protection devices	High pressure protection		High pressure sensor, High pressure switch at 4.15 MPa (601 psi)		
	Inverter circuit (COMP./FAN)		Over-current protection		
	Fan motor		-		
Refrigerant	Type x original charge		R410A x 26 lbs + 1 oz (11.8 kg)		
	Control		Indoor LEV and BC controller		
Net weight		lbs (kg)	918 (416)		
Heat exchanger			Salt-resistant cross fin & aluminium tube		
HIC circuit (HIC: Heat Inter-Changer)			-		
Defrosting method			Auto-defrost mode (Reversed refrigerant cycle)		
Drawing	External		KB94C1J6		
	Wiring		KE94G983		
Standard attachment	Document		Installation Manual		
	Accessory		Details refer to External Drw		
Optional parts			joint: CMY-Y102SS-G2, CMY-Y102LS-G2, CMY-R160-J1 Main BC controller: CMB-P108, 1012, 1016NU-JA1, CMB-P1016NU-KA1 Sub BC controller: CMB-P104, 108NU-KB1		
Remarks			Details on foundation work, duct work, insulation work, electrical wiring, power source switch, and other items shall be referred to the Installation Manual.		

Notes:		Unit converter
1.Nominal cooling conditions (Test conditions are based on AHRI 1230) Indoor: 80°F D.B./67°F W.B. (26.7°C D.B./19.4°C W.B.), Outdoor: 95°F D.B. (35°C D.B.)		BTU/h =kW x 3.412
2.Nominal heating conditions (Test conditions are based on AHRI 1230) Indoor: 70°F D.B. (21.1°C D.B.), Outdoor: 47°F D.B./43°F W.B. (8.3°C D.B./6.1°C W.B.)		cfm =m ³ /min x 35.31
3.Cooling mode/Heating mode		lbs =kg/0.4536
4.External static pressure option is available (0.12 in.WG, 0.24 in.WG, 0.32 in.WG/30 Pa, 60 Pa, 80 Pa).		
* Due to continuing improvement, above specifications may be subject to change without notice.		*Above specification data is subject to rounding variation.

1. SPECIFICATIONS

R2-Series (High efficiency)

PURY-EP-T(S)NU-A, Y(S)NU-A

Outdoor Model			PURY-EP192YSNU-A (-BS)			
Indoor Model			Non-Ducted		Ducted	
Power source			3-phase 3-wire 460 V ±10% 60 Hz			
Cooling capacity (Nominal)	*1	BTU/h	192,000			
		kW	56.3			
	(460)	Power input	kW	13.60		
		Current input	A	18.9		
	(Rated)		BTU/h	183,000		
			kW	53.6		
(460)	Power input	kW	12.35	12.83		
	Current input	A	17.2	17.8		
Temp. range of cooling	Indoor	W.B.	59~75°F (15~24°C)			
	Outdoor	D.B.	23~126°F (-5~52°C)			
Heating capacity (Nominal)	*2	BTU/h	215,000			
		kW	63.0			
	(460)	Power input	kW	16.02		
		Current input	A	22.3		
	(Rated)		BTU/h	205,000		
			kW	60.1		
(460)	Power input	kW	14.53	15.13		
	Current input	A	20.2	21.0		
Temp. range of heating	Indoor	D.B.	59~81°F (15~27°C)			
	Outdoor	W.B.	-13~60°F (-25~15.5°C)			
Indoor unit connectable	Total capacity	50~150% of outdoor unit capacity				
	Model/Quantity	P04-P96/1~48				
Sound power level (measured in anechoic room) *3		dB <A>	80.5/82.0			
Refrigerant piping diameter	High pressure	in. (mm)	7/8 (22.2) Brazed			
	Low pressure	in. (mm)	1-1/8 (28.58) Brazed			

Set Model			PURY-EP96YNU-A (-BS)		PURY-EP96YNU-A (-BS)		
Model		A		20		20	
Minimum Circuit Ampacity		A		30		30	
Maximum Overcurrent Protection		A		30		30	
FAN	Type x Quantity		Propeller fan x 2		Propeller fan x 2		
	Airflow rate	cfm	7,400		7,400		
		m ³ /min	210		210		
		L/s	3,500		3,500		
	Control, Driving mechanism		Inverter-control, Brushless DC motor		Inverter-control, Brushless DC motor		
	Motor output	kW	0.46+0.46		0.46+0.46		
*4 External static press.		0 in.WG (0 Pa)		0 in.WG (0 Pa)			
Compressor	Type x Quantity		Inverter scroll hermetic compressor x 1		Inverter scroll hermetic compressor x 1		
	Starting method		Inverter		Inverter		
	Motor output	kW	5.5		5.5		
	Case heater	kW	-		-		
	Lubricant		MEL32		MEL32		
External finish		Pre-coated galvanized steel sheet (+powder coating for -BS type) <MUNSELL 5Y 8/1>		Pre-coated galvanized steel sheet (+powder coating for -BS type) <MUNSELL 5Y 8/1>			
External dimension H x W x D		in.	71-5/8 x 48-7/8 x 29-3/16		71-5/8 x 48-7/8 x 29-3/16		
		mm	1,818 x 1,240 x 740		1,818 x 1,240 x 740		
Protection devices	High pressure protection		High pressure sensor, High pressure switch at 4.15 MPa (601 psi)		High pressure sensor, High pressure switch at 4.15 MPa (601 psi)		
	Inverter circuit (COMP./FAN)		Over-heat protection, Over-current protection		Over-heat protection, Over-current protection		
	Fan motor		-		-		
Refrigerant	Type x original charge		R410A x 17 lbs + 10 oz (8.0 kg)		R410A x 17 lbs + 10 oz (8.0 kg)		
	Control		Indoor LEV and BC controller				
Net weight		lbs (kg)	649 (294)		649 (294)		
Heat exchanger		Salt-resistant cross fin & aluminium tube				Salt-resistant cross fin & aluminium tube	
HIC circuit (HIC: Heat Inter-Changer)		-				-	
Pipe between unit and distributor	High pressure	in. (mm)	3/4 (19.05) Brazed		3/4 (19.05) Brazed		
	Low pressure	in. (mm)	7/8 (22.2) Brazed		7/8 (22.2) Brazed		
Defrosting method		Auto-defrost mode (Reversed refrigerant cycle)					
Drawing	External	KL94R885					
	Wiring	KE94G652		KE94G652			
Standard attachment	Document	Installation Manual					
	Accessory	Details refer to External Drw					
Optional parts		Outdoor Twinning kit: CMY-R200NCBK joint: CMY-Y102SS-G2, CMY-Y102LS-G2, CMY-R160-J1 Main BC controller: CMB-P108, 1012, 1016NU-JA1, CMB-P1016NU-KA1 Sub BC controller: CMB-P104, 108NU-KB1					
Remarks		Details on foundation work, duct work, insulation work, electrical wiring, power source switch, and other items shall be referred to the Installation Manual.					

Notes:	Unit converter
1. Nominal cooling conditions (Test conditions are based on AHR1 1230) Indoor: 80°F D.B./67°F W.B. (26.7°C D.B./19.4°C W.B.), Outdoor: 95°F D.B. (35°C D.B.)	BTU/h = kW x 3,412
2. Nominal heating conditions (Test conditions are based on AHR1 1230) Indoor: 70°F D.B. (21.1°C D.B.), Outdoor: 47°F D.B./43°F W.B. (8.3°C D.B./6.1°C W.B.)	cfm = m ³ /min x 35.31
3. Cooling mode/Heating mode	lbs = kg/0.4536
4. External static pressure option is available (0.12 in.WG, 0.24 in.WG, 0.32 in.WG/30 Pa, 60 Pa, 80 Pa).	
* Due to continuing improvement, above specifications may be subject to change without notice.	*Above specification data is subject to rounding variation.

1. SPECIFICATIONS

R2-Series (High efficiency)

PURY-EP-T(S)NU-A, Y(S)NU-A

Outdoor Model			PURY-EP216YSNU-A (-BS)		
Indoor Model			Non-Ducted		Ducted
Power source			3-phase 3-wire 460 V ±10% 60 Hz		
Cooling capacity (Nominal)	*1	BTU/h	216,000		
		kW	63.3		
	(460)	Power input	16.06		
		Current input	22.3		
	(Rated)	BTU/h	206,000		
		kW	60.4		
	(460)	Power input	14.61	15.12	
		Current input	20.3	21.0	
Temp. range of cooling	Indoor	W.B.	59~75°F (15~24°C)		
	Outdoor	D.B.	23~126°F (-5~52°C)		
Heating capacity (Nominal)	*2	BTU/h	243,000		
		kW	71.2		
	(460)	Power input	18.67		
		Current input	26.0		
	(Rated)	BTU/h	232,000		
		kW	68.0		
	(460)	Power input	16.91	17.65	
		Current input	23.5	24.6	
Temp. range of heating	Indoor	D.B.	59~81°F (15~27°C)		
	Outdoor	W.B.	-13~60°F (-25~15.5°C)		
Indoor unit connectable	Total capacity	50~150% of outdoor unit capacity			
	Model/Quantity	P04-P96/2~50			
Sound power level (measured in anechoic room) *3	dB <A>	82.0/83.0			
Refrigerant piping diameter	High pressure	in. (mm)	7/8 (22.2) Brazed (1-1/8 (28.58) Brazed for the part that exceeds 65 m)		
	Low pressure	in. (mm)	1-3/8 (34.93) Brazed		

Set Model			PURY-EP120YNU-A (-BS)		PURY-EP96YNU-A (-BS)	
Model			PURY-EP120YNU-A (-BS)		PURY-EP96YNU-A (-BS)	
Minimum Circuit Ampacity	A		26		20	
Maximum Overcurrent Protection	A		40		30	
FAN	Type x Quantity	Propeller fan x 2		Propeller fan x 2		
	Airflow rate	cfm	8,300		7,400	
		m ³ /min	235		210	
		L/s	3,920		3,500	
	Control, Driving mechanism	Inverter-control, Brushless DC motor		Inverter-control, Brushless DC motor		
	Motor output	kW	0.46+0.46		0.46+0.46	
External static press.	0 in.WG (0 Pa)		0 in.WG (0 Pa)			
Compressor	Type x Quantity	Inverter scroll hermetic compressor x 1		Inverter scroll hermetic compressor x 1		
	Starting method	Inverter		Inverter		
	Motor output	kW	7.6		5.5	
	Case heater	kW	-		-	
	Lubricant	MEL32		MEL32		
External finish	Pre-coated galvanized steel sheet (+powder coating for -BS type) <MUNSELL 5Y 8/1>		Pre-coated galvanized steel sheet (+powder coating for -BS type) <MUNSELL 5Y 8/1>			
External dimension H x W x D	in.	71-5/8 x 48-7/8 x 29-3/16		71-5/8 x 48-7/8 x 29-3/16		
	mm	1,818 x 1,240 x 740		1,818 x 1,240 x 740		
Protection devices	High pressure protection	High pressure sensor, High pressure switch at 4.15 MPa (601 psi)		High pressure sensor, High pressure switch at 4.15 MPa (601 psi)		
	Inverter circuit (COMP./FAN)	Over-heat protection, Over-current protection		Over-heat protection, Over-current protection		
	Fan motor	-		-		
Refrigerant	Type x original charge	R410A x 17 lbs + 10 oz (8.0 kg)		R410A x 17 lbs + 10 oz (8.0 kg)		
	Control	Indoor LEV and BC controller				
Net weight	lbs (kg)	657 (298)		649 (294)		
Heat exchanger	Salt-resistant cross fin & aluminium tube		Salt-resistant cross fin & aluminium tube			
HIC circuit (HIC: Heat Inter-Changer)	-		-			
Pipe between unit and distributor	High pressure	in. (mm)	3/4 (19.05) Brazed		3/4 (19.05) Brazed	
	Low pressure	in. (mm)	1-1/8 (28.58) Brazed		7/8 (22.2) Brazed	
Defrosting method	Auto-defrost mode (Reversed refrigerant cycle)					
Drawing	External	KL94R885				
	Wiring	KE94G652		KE94G652		
Standard attachment	Document	Installation Manual				
	Accessory	Details refer to External Drw				
Optional parts	Outdoor Twinning kit: CMY-R200NCBK joint: CMY-Y102SS-G2, CMY-Y102LS-G2, CMY-R160-J1 Main BC controller: CMB-P108, 1012, 1016NU-JA1, CMB-P1016NU-KA1 Sub BC controller: CMB-P104, 108NU-KB1					
Remarks	Details on foundation work, duct work, insulation work, electrical wiring, power source switch, and other items shall be referred to the Installation Manual.					

Notes:	Unit converter
1.Nominal cooling conditions (Test conditions are based on AHRI 1230) Indoor: 80°F D.B./67°F W.B. (26.7°C D.B./19.4°C W.B.), Outdoor: 95°F D.B. (35°C D.B.)	BTU/h = kW x 3,412
2.Nominal heating conditions (Test conditions are based on AHRI 1230) Indoor: 70°F D.B. (21.1°C D.B.), Outdoor: 47°F D.B./43°F W.B. (8.3°C D.B./6.1°C W.B.)	cfm = m ³ /min x 35.31
3.Cooling mode/Heating mode	lbs = kg/0.4536
4.External static pressure option is available (0.12 in.WG, 0.24 in.WG, 0.32 in.WG/30 Pa, 60 Pa, 80 Pa).	
* Due to continuing improvement, above specifications may be subject to change without notice.	*Above specification data is subject to rounding variation.

1. SPECIFICATIONS

R2-Series (High efficiency)

PURY-EP-T(S)NU-A, Y(S)NU-A

Outdoor Model			PURY-EP240YSNU-A (-BS)			
Indoor Model			Non-Ducted	Ducted		
Power source			3-phase 3-wire 460 V ±10% 60 Hz			
Cooling capacity (Nominal)	*1	BTU/h	240,000			
		kW	70.3			
		Power input kW	19.17			
	(460)	Current input	A	26.7		
		(Rated)	BTU/h	228,000		
			kW	66.8		
Power input kW	17.92		17.58			
(460)	Current input	A	24.9	24.5		
	Temp. range of cooling	Indoor	W.B.	59~75°F (15~24°C)		
		Outdoor	D.B.	23~126°F (-5~52°C)		
Heating capacity (Nominal)	*2	BTU/h	270,000			
		kW	79.1			
		Power input kW	22.03			
	(460)	Current input	A	30.7		
		(Rated)	BTU/h	258,000		
			kW	75.6		
Power input kW	20.52		20.27			
(460)	Current input	A	28.6	28.2		
	Temp. range of heating	Indoor	D.B.	59~81°F (15~27°C)		
		Outdoor	W.B.	-13~60°F (-25~15.5°C)		
Indoor unit connectable	Total capacity	50~150% of outdoor unit capacity				
	Model/Quantity	P04-P96/2-50				
Sound power level (measured in anechoic room) *3		dB <A>	83.0/83.5			
Refrigerant piping diameter	High pressure	in. (mm)	7/8 (22.2) Brazed (1-1/8 (28.58) Brazed for the part that exceeds 65 m)			
	Low pressure	in. (mm)	1-3/8 (34.93) Brazed			

Set Model			PURY-EP120YNU-A (-BS)		PURY-EP120YNU-A (-BS)	
Model			PURY-EP120YNU-A (-BS)		PURY-EP120YNU-A (-BS)	
Minimum Circuit Ampacity		A	26		26	
Maximum Overcurrent Protection		A	40		40	
FAN	Type x Quantity		Propeller fan x 2		Propeller fan x 2	
	Airflow rate	cfm	8,300		8,300	
		m ³ /min	235		235	
		L/s	3,920		3,920	
	Control, Driving mechanism		Inverter-control, Brushless DC motor		Inverter-control, Brushless DC motor	
	Motor output	kW	0.46+0.46		0.46+0.46	
*4 External static press.			0 in.WG (0 Pa)		0 in.WG (0 Pa)	
Compressor	Type x Quantity		Inverter scroll hermetic compressor x 1		Inverter scroll hermetic compressor x 1	
	Starting method		Inverter		Inverter	
	Motor output	kW	7.6		7.6	
	Case heater	kW	-		-	
	Lubricant		MEL32		MEL32	
External finish		Pre-coated galvanized steel sheet (+powder coating for -BS type) <MUNSELL 5Y 8/1>		Pre-coated galvanized steel sheet (+powder coating for -BS type) <MUNSELL 5Y 8/1>		
External dimension H x W x D		in.	71-5/8 x 48-7/8 x 29-3/16		71-5/8 x 48-7/8 x 29-3/16	
		mm	1,818 x 1,240 x 740		1,818 x 1,240 x 740	
Protection devices	High pressure protection		High pressure sensor, High pressure switch at 4.15 MPa (601 psi)		High pressure sensor, High pressure switch at 4.15 MPa (601 psi)	
	Inverter circuit (COMP./FAN)		Over-heat protection, Over-current protection		Over-heat protection, Over-current protection	
	Fan motor		-		-	
Refrigerant	Type x original charge		R410A x 17 lbs + 10 oz (8.0 kg)		R410A x 17 lbs + 10 oz (8.0 kg)	
	Control		Indoor LEV and BC controller			
Net weight		lbs (kg)	657 (298)		657 (298)	
Heat exchanger		Salt-resistant cross fin & aluminium tube				
HIC circuit (HIC: Heat Inter-Changer)		-				
Pipe between unit and distributor	High pressure	in. (mm)	3/4 (19.05) Brazed		3/4 (19.05) Brazed	
	Low pressure	in. (mm)	1-1/8 (28.58) Brazed		1-1/8 (28.58) Brazed	
Defrosting method		Auto-defrost mode (Reversed refrigerant cycle)				
Drawing	External	KL94R885				
	Wiring	KE94G652		KE94G652		
Standard attachment	Document	Installation Manual				
	Accessory	Details refer to External Drw				
Optional parts		Outdoor Twinning kit: CMY-R200NCBK joint: CMY-Y102SS-G2, CMY-Y102LS-G2, CMY-R160-J1 Main BC controller: CMB-P108, 1012, 1016NU-JA1, CMB-P1016NU-KA1 Sub BC controller: CMB-P104, 108NU-KB1				
Remarks		Details on foundation work, duct work, insulation work, electrical wiring, power source switch, and other items shall be referred to the Installation Manual.				

Notes:	Unit converter
1. Nominal cooling conditions (Test conditions are based on AHR1 1230) Indoor: 80°F D.B./67°F W.B. (26.7°C D.B./19.4°C W.B.), Outdoor: 95°F D.B. (35°C D.B.)	BTU/h = kW x 3,412
2. Nominal heating conditions (Test conditions are based on AHR1 1230) Indoor: 70°F D.B. (21.1°C D.B.), Outdoor: 47°F D.B./43°F W.B. (8.3°C D.B./6.1°C W.B.)	cfm = m ³ /min x 35.31
3. Cooling mode/Heating mode	lbs = kg/0.4536
4. External static pressure option is available (0.12 in.WG, 0.24 in.WG, 0.32 in.WG/30 Pa, 60 Pa, 80 Pa).	
* Due to continuing improvement, above specifications may be subject to change without notice.	*Above specification data is subject to rounding variation.

1. SPECIFICATIONS

R2-Series (High efficiency)

PURY-EP-T(S)NU-A, Y(S)NU-A

Outdoor Model			PURY-EP264YSNU-A (-BS)	
Indoor Model			Non-Ducted	Ducted
Power source			3-phase 3-wire 460 V ±10% 60 Hz	
Cooling capacity (Nominal)	*1	BTU/h	264,000	
		kW	77.4	
	(460)	Power input	21.86	
		Current input	30.4	
	(Rated)	BTU/h	250,000	
		kW	73.3	
	(460)	Power input	20.11	19.97
		Current input	28.0	27.8
Temp. range of cooling	Indoor	W.B.	59~75°F (15~24°C)	
	Outdoor	D.B.	23~126°F (-5~52°C)	
Heating capacity (Nominal)	*2	BTU/h	295,000	
		kW	86.5	
	(460)	Power input	24.56	
		Current input	34.2	
	(Rated)	BTU/h	280,000	
		kW	82.1	
	(460)	Power input	22.58	22.68
		Current input	31.4	31.6
Temp. range of heating	Indoor	D.B.	59~81°F (15~27°C)	
	Outdoor	W.B.	-13~60°F (-25~15.5°C)	
Indoor unit connectable	Total capacity	50~150% of outdoor unit capacity		
	Model/Quantity	P04-P96/2~50		
Sound power level (measured in anechoic room) *3	dB <A>	87.0/87.0		
Refrigerant piping diameter	High pressure	in. (mm)	1-1/8 (28.58) Brazed	
	Low pressure	in. (mm)	1-3/8 (34.93) Brazed	

Set Model			PURY-EP144YNU-A (-BS)	PURY-EP120YNU-A (-BS)
Model			PURY-EP144YNU-A (-BS)	PURY-EP120YNU-A (-BS)
Minimum Circuit Ampacity	A		34	26
Maximum Overcurrent Protection	A		50	40
FAN	Type x Quantity		Propeller fan x 2	Propeller fan x 2
	Airflow rate	cfm	9,550	8,300
		m ³ /min	270	235
		L/s	4,500	3,920
	Control, Driving mechanism		Inverter-control, Brushless DC motor	Inverter-control, Brushless DC motor
	Motor output	kW	0.46+0.46	0.46+0.46
External static press.		0 in.WG (0 Pa)	0 in.WG (0 Pa)	
Compressor	Type x Quantity		Inverter scroll hermetic compressor x 1	Inverter scroll hermetic compressor x 1
	Starting method		Inverter	Inverter
	Motor output	kW	9.8	7.6
	Case heater	kW	-	-
	Lubricant		MEL32	MEL32
External finish			Pre-coated galvanized steel sheet (+powder coating for -BS type) <MUNSELL 5Y 8/1>	Pre-coated galvanized steel sheet (+powder coating for -BS type) <MUNSELL 5Y 8/1>
External dimension H x W x D	in.		71-5/8 x 48-7/8 x 29-3/16	71-5/8 x 48-7/8 x 29-3/16
	mm		1,818 x 1,240 x 740	1,818 x 1,240 x 740
Protection devices	High pressure protection		High pressure sensor, High pressure switch at 4.15 MPa (601 psi)	High pressure sensor, High pressure switch at 4.15 MPa (601 psi)
	Inverter circuit (COMP./FAN)		Over-heat protection, Over-current protection	Over-heat protection, Over-current protection
	Fan motor		-	-
Refrigerant	Type x original charge		R410A x 23 lbs + 12 oz (10.8 kg)	R410A x 17 lbs + 10 oz (8.0 kg)
	Control		Indoor LEV and BC controller	
Net weight	lbs (kg)		715 (324)	657 (298)
Heat exchanger			Salt-resistant cross fin & aluminium tube	Salt-resistant cross fin & aluminium tube
HIC circuit (HIC: Heat Inter-Changer)			-	-
Pipe between unit and distributor	High pressure	in. (mm)	7/8 (22.2) Brazed	3/4 (19.05) Brazed
	Low pressure	in. (mm)	1-1/8 (28.58) Brazed	1-1/8 (28.58) Brazed
Defrosting method			Auto-defrost mode (Reversed refrigerant cycle)	
Drawing	External		KL94R885	
	Wiring		KE94G652	KE94G652
Standard attachment	Document		Installation Manual	
	Accessory		Details refer to External Drw	
Optional parts			Outdoor Twinning kit: CMY-R300NCBK joint: CMY-Y102SS-G2, CMY-Y102LS-G2, CMY-R160-J1 Main BC controller: CMB-P108, 1012, 1016NU-JA1, CMB-P1016NU-KA1 Sub BC controller: CMB-P104, 108NU-KB1	
Remarks			Details on foundation work, duct work, insulation work, electrical wiring, power source switch, and other items shall be referred to the Installation Manual.	

Notes:	Unit converter
1.Nominal cooling conditions (Test conditions are based on AHRI 1230) Indoor: 80°F D.B./67°F W.B. (26.7°C D.B./19.4°C W.B.), Outdoor: 95°F D.B. (35°C D.B.)	BTU/h = kW x 3,412
2.Nominal heating conditions (Test conditions are based on AHRI 1230) Indoor: 70°F D.B. (21.1°C D.B.), Outdoor: 47°F D.B./43°F W.B. (8.3°C D.B./6.1°C W.B.)	cfm = m ³ /min x 35.31
3.Cooling mode/Heating mode	lbs = kg/0.4536
4.External static pressure option is available (0.12 in.WG, 0.24 in.WG, 0.32 in.WG/30 Pa, 60 Pa, 80 Pa).	
* Due to continuing improvement, above specifications may be subject to change without notice.	*Above specification data is subject to rounding variation.

1. SPECIFICATIONS

R2-Series (High efficiency)

PURY-EP-T(S)NU-A, Y(S)NU-A

Outdoor Model		PURY-EP288YSNU-A (-BS)		
Indoor Model		Non-Ducted	Ducted	
Power source		3-phase 3-wire 460 V ±10% 60 Hz		
Cooling capacity (Nominal)	*1	BTU/h	288,000	
		kW	84.4	
	(460)	Power input	24.83	
		Current input	34.6	
	(Rated)	BTU/h	274,000	
		kW	80.3	
(460)	Power input	23.02	22.95	
	Current input	32.1	32.0	
Temp. range of cooling	Indoor	W.B.	59~75°F (15~24°C)	
	Outdoor	D.B.	23~126°F (-5~52°C)	
Heating capacity (Nominal)	*2	BTU/h	323,000	
		kW	94.7	
	(460)	Power input	27.30	
		Current input	38.0	
	(Rated)	BTU/h	304,000	
		kW	89.1	
(460)	Power input	25.07	25.47	
	Current input	34.9	35.5	
Temp. range of heating	Indoor	D.B.	59~81°F (15~27°C)	
	Outdoor	W.B.	-13~60°F (-25~15.5°C)	
Indoor unit connectable	Total capacity	50~150% of outdoor unit capacity		
	Model/Quantity	P04-P96/2~50		
Sound power level (measured in anechoic room) *3		dB <A>		
		88.5/88.5		
Refrigerant piping diameter	High pressure	in. (mm)		
	Low pressure	1-1/8 (28.58) Brazed		
		1-3/8 (34.93) Brazed		

Set Model		PURY-EP144YNU-A (-BS)		PURY-EP144YNU-A (-BS)		
Model		PURY-EP144YNU-A (-BS)		PURY-EP144YNU-A (-BS)		
Minimum Circuit Ampacity		A		34		
Maximum Overcurrent Protection		A		50		
FAN	Type x Quantity		Propeller fan x 2		Propeller fan x 2	
	Airflow rate	cfm	9,550		9,550	
		m ³ /min	270		270	
		L/s	4,500		4,500	
	Control, Driving mechanism		Inverter-control, Brushless DC motor		Inverter-control, Brushless DC motor	
	*4 Motor output		kW		0.46+0.46	
External static press.		0 in.WG (0 Pa)		0 in.WG (0 Pa)		
Compressor	Type x Quantity		Inverter scroll hermetic compressor x 1		Inverter scroll hermetic compressor x 1	
	Starting method		Inverter		Inverter	
	Motor output		kW		9.8	
	Case heater		kW		-	
	Lubricant		MEL32		MEL32	
External finish		Pre-coated galvanized steel sheet (+powder coating for -BS type) <MUNSELL 5Y 8/1>		Pre-coated galvanized steel sheet (+powder coating for -BS type) <MUNSELL 5Y 8/1>		
External dimension H x W x D		in.	71-5/8 x 48-7/8 x 29-3/16		71-5/8 x 48-7/8 x 29-3/16	
		mm	1,818 x 1,240 x 740		1,818 x 1,240 x 740	
Protection devices	High pressure protection		High pressure sensor, High pressure switch at 4.15 MPa (601 psi)		High pressure sensor, High pressure switch at 4.15 MPa (601 psi)	
	Inverter circuit (COMP./FAN)		Over-heat protection, Over-current protection		Over-heat protection, Over-current protection	
	Fan motor		-		-	
Refrigerant	Type x original charge		R410A x 23 lbs + 12 oz (10.8 kg)		R410A x 23 lbs + 12 oz (10.8 kg)	
	Control		Indoor LEV and BC controller			
Net weight		lbs (kg)	715 (324)		715 (324)	
Heat exchanger		Salt-resistant cross fin & aluminium tube				
HIC circuit (HIC: Heat Inter-Changer)		-				
Pipe between unit and distributor	High pressure	in. (mm)	7/8 (22.2) Brazed		7/8 (22.2) Brazed	
	Low pressure	in. (mm)	1-1/8 (28.58) Brazed		1-1/8 (28.58) Brazed	
Defrosting method		Auto-defrost mode (Reversed refrigerant cycle)				
Drawing	External	KL94R885				
	Wiring	KE94G652		KE94G652		
Standard attachment	Document	Installation Manual				
	Accessory	Details refer to External Drw				
Optional parts		Outdoor Twinning kit: CMY-R30NCBK joint: CMY-Y102SS-G2, CMY-Y102LS-G2, CMY-R160-J1 Main BC controller: CMB-P108, 1012, 1016NU-JA1, CMB-P1016NU-KA1 Sub BC controller: CMB-P104, 108NU-KB1				
Remarks		Details on foundation work, duct work, insulation work, electrical wiring, power source switch, and other items shall be referred to the Installation Manual.				

Notes:	Unit converter
1. Nominal cooling conditions (Test conditions are based on AHRI 1230) Indoor: 80°F D.B./67°F W.B. (26.7°C D.B./19.4°C W.B.), Outdoor: 95°F D.B. (35°C D.B.)	BTU/h = kW x 3,412
2. Nominal heating conditions (Test conditions are based on AHRI 1230) Indoor: 70°F D.B. (21.1°C D.B.), Outdoor: 47°F D.B./43°F W.B. (8.3°C D.B./6.1°C W.B.)	cfm = m ³ /min x 35.31
3. Cooling mode/Heating mode	lbs = kg/0.4536
4. External static pressure option is available (0.12 in.WG, 0.24 in.WG, 0.32 in.WG/30 Pa, 60 Pa, 80 Pa).	
* Due to continuing improvement, above specifications may be subject to change without notice.	*Above specification data is subject to rounding variation.

1. SPECIFICATIONS

R2-Series (High efficiency)

PURY-EP-T(S)NU-A, Y(S)NU-A

Outdoor Model			PURY-EP312YSNU-A (-BS)			
Indoor Model			Non-Ducted		Ducted	
Power source			3-phase 3-wire 460 V ±10% 60 Hz			
Cooling capacity (Nominal)	*1	BTU/h	312,000			
		kW	91.4			
	(460)	Power input	27.98			
		Current input	39.0			
		(Rated)	BTU/h	296,000		
			kW	86.8		
(460)	Power input	26.11	25.18			
	Current input	36.4	35.1			
Temp. range of cooling	Indoor	W.B.	59~75°F (15~24°C)			
	Outdoor	D.B.	23~126°F (-5~52°C)			
Heating capacity (Nominal)	*2	BTU/h	350,000			
		kW	102.6			
	(460)	Power input	30.53			
		Current input	42.5			
		(Rated)	BTU/h	334,000		
			kW	97.9		
(460)	Power input	28.32	28.21			
	Current input	39.4	39.3			
Temp. range of heating	Indoor	D.B.	59~81°F (15~27°C)			
	Outdoor	W.B.	-13~60°F (-25~15.5°C)			
Indoor unit connectable	Total capacity	50~150% of outdoor unit capacity				
	Model/Quantity	P04-P96/2~50				
Sound power level (measured in anechoic room) *3	dB <A>	87.0/88.5				
Refrigerant piping diameter	High pressure	in. (mm)	1-1/8 (28.58) Brazed			
	Low pressure	in. (mm)	1-5/8 (41.28) Brazed			

Set Model			PURY-EP168YNU-A (-BS)		PURY-EP144YNU-A (-BS)	
Model			PURY-EP168YNU-A (-BS)		PURY-EP144YNU-A (-BS)	
Minimum Circuit Ampacity	A		35		34	
Maximum Overcurrent Protection	A		50		50	
FAN	Type x Quantity		Propeller fan x 2		Propeller fan x 2	
	Airflow rate	cfm	14,850		9,550	
		m ³ /min	420		270	
		L/s	7,000		4,500	
	Control, Driving mechanism		Inverter-control, Brushless DC motor		Inverter-control, Brushless DC motor	
	Motor output	kW	0.92+0.92		0.46+0.46	
External static press.		0 in.WG (0 Pa)		0 in.WG (0 Pa)		
Compressor	Type x Quantity		Inverter scroll hermetic compressor x 1		Inverter scroll hermetic compressor x 1	
	Starting method		Inverter		Inverter	
	Motor output	kW	12.2		9.8	
	Case heater	kW	-		-	
	Lubricant		MEL32		MEL32	
External finish			Pre-coated galvanized steel sheet (+powder coating for -BS type) <MUNSELL 5Y 8/1>		Pre-coated galvanized steel sheet (+powder coating for -BS type) <MUNSELL 5Y 8/1>	
External dimension H x W x D			in. 71-5/8 x 68-15/16 x 29-3/16 mm 1,818 x 1,750 x 740		in. 71-5/8 x 48-7/8 x 29-3/16 mm 1,818 x 1,240 x 740	
Protection devices	High pressure protection		High pressure sensor, High pressure switch at 4.15 MPa (601 psi)		High pressure sensor, High pressure switch at 4.15 MPa (601 psi)	
	Inverter circuit (COMP./FAN)		Over-heat protection, Over-current protection		Over-heat protection, Over-current protection	
	Fan motor		-		-	
Refrigerant	Type x original charge		R410A x 23 lbs + 12 oz (10.8 kg)		R410A x 23 lbs + 12 oz (10.8 kg)	
	Control		Indoor LEV and BC controller			
Net weight	lbs (kg)		807 (366)		715 (324)	
Heat exchanger			Salt-resistant cross fin & aluminium tube		Salt-resistant cross fin & aluminium tube	
HIC circuit (HIC: Heat Inter-Changer)			-			
Pipe between unit and distributor	High pressure	in. (mm)	7/8 (22.2) Brazed		7/8 (22.2) Brazed	
	Low pressure	in. (mm)	1-1/8 (28.58) Brazed		1-1/8 (28.58) Brazed	
Defrosting method			Auto-defrost mode (Reversed refrigerant cycle)			
Drawing	External		KL94R886			
	Wiring		KE94G651		KE94G652	
Standard attachment	Document		Installation Manual			
	Accessory		Details refer to External Drw			
Optional parts			Outdoor Twinning kit: CMY-R300NCBK joint: CMY-Y102SS-G2, CMY-Y102LS-G2, CMY-R160-J1 Main BC controller: CMB-P108, 1012, 1016NU-JA1, CMB-P1016NU-KA1 Sub BC controller: CMB-P104, 108NU-KB1			
Remarks			Details on foundation work, duct work, insulation work, electrical wiring, power source switch, and other items shall be referred to the Installation Manual.			

Notes:	Unit converter
1. Nominal cooling conditions (Test conditions are based on AHRI 1230) Indoor: 80°F D.B./67°F W.B. (26.7°C D.B./19.4°C W.B.), Outdoor: 95°F D.B. (35°C D.B.)	BTU/h = kW x 3,412
2. Nominal heating conditions (Test conditions are based on AHRI 1230) Indoor: 70°F D.B. (21.1°C D.B.), Outdoor: 47°F D.B./43°F W.B. (8.3°C D.B./6.1°C W.B.)	cfm = m ³ /min x 35.31
3. Cooling mode/Heating mode	lbs = kg/0.4536
4. External static pressure option is available (0.12 in.WG, 0.24 in.WG, 0.32 in.WG/30 Pa, 60 Pa, 80 Pa).	
* Due to continuing improvement, above specifications may be subject to change without notice.	*Above specification data is subject to rounding variation.

1. SPECIFICATIONS

R2-Series (High efficiency)

PURY-EP-T(S)NU-A, Y(S)NU-A

Outdoor Model		PURY-EP336YSNU-A (-BS)		
Indoor Model		Non-Ducted	Ducted	
Power source		3-phase 3-wire 460 V ±10% 60 Hz		
Cooling capacity (Nominal)	*1	BTU/h	336,000	
		kW	98.5	
	(460)	Power input	31.43	
		Current input	43.8	
	(Rated)		BTU/h	320,000
			kW	93.8
(460)	Power input	30.12	28.08	
	Current input	42.0	39.1	
Temp. range of cooling	Indoor	W.B.	59~75°F (15~24°C)	
	Outdoor	D.B.	23~126°F (-5~52°C)	
Heating capacity (Nominal)	*2	BTU/h	378,000	
		kW	110.8	
	(460)	Power input	33.55	
		Current input	46.7	
	(Rated)		BTU/h	360,000
			kW	105.5
(460)	Power input	31.29	30.63	
	Current input	43.6	42.7	
Temp. range of heating	Indoor	D.B.	59~81°F (15~27°C)	
	Outdoor	W.B.	-13~60°F (-25~15.5°C)	
Indoor unit connectable	Total capacity	50~150% of outdoor unit capacity		
	Model/Quantity	P04-P96/2~50		
Sound power level (measured in anechoic room) *3		dB <A>		
		84.5/88.5		
Refrigerant piping diameter	High pressure	in. (mm)	1-1/8 (28.58) Brazed	
	Low pressure	in. (mm)	1-5/8 (41.28) Brazed	

Set Model		PURY-EP168YNU-A (-BS)		PURY-EP168YNU-A (-BS)		
Model		PURY-EP168YNU-A (-BS)		PURY-EP168YNU-A (-BS)		
Minimum Circuit Ampacity		A	35	35		
Maximum Overcurrent Protection		A	50	50		
FAN	Type x Quantity		Propeller fan x 2		Propeller fan x 2	
	Airflow rate	cfm	14,850	14,850		
		m ³ /min	420	420		
		L/s	7,000	7,000		
	Control, Driving mechanism		Inverter-control, Brushless DC motor		Inverter-control, Brushless DC motor	
	Motor output	kW	0.92+0.92	0.92+0.92		
External static press.		0 in.WG (0 Pa)		0 in.WG (0 Pa)		
Compressor	Type x Quantity		Inverter scroll hermetic compressor x 1		Inverter scroll hermetic compressor x 1	
	Starting method		Inverter		Inverter	
	Motor output	kW	12.2	12.2		
	Case heater	kW	-	-		
	Lubricant		MEL32		MEL32	
External finish		Pre-coated galvanized steel sheet (+powder coating for -BS type) <MUNSELL 5Y 8/1>		Pre-coated galvanized steel sheet (+powder coating for -BS type) <MUNSELL 5Y 8/1>		
External dimension H x W x D		in.	71-5/8 x 68-15/16 x 29-3/16	71-5/8 x 68-15/16 x 29-3/16		
		mm	1,818 x 1,750 x 740	1,818 x 1,750 x 740		
Protection devices	High pressure protection		High pressure sensor, High pressure switch at 4.15 MPa (601 psi)		High pressure sensor, High pressure switch at 4.15 MPa (601 psi)	
	Inverter circuit (COMP./FAN)		Over-heat protection, Over-current protection		Over-heat protection, Over-current protection	
	Fan motor		-		-	
Refrigerant	Type x original charge		R410A x 23 lbs + 12 oz (10.8 kg)		R410A x 23 lbs + 12 oz (10.8 kg)	
	Control		Indoor LEV and BC controller			
Net weight		lbs (kg)	807 (366)	807 (366)		
Heat exchanger		Salt-resistant cross fin & aluminium tube		Salt-resistant cross fin & aluminium tube		
HIC circuit (HIC: Heat Inter-Changer)		-		-		
Pipe between unit and distributor	High pressure	in. (mm)	7/8 (22.2) Brazed	7/8 (22.2) Brazed		
	Low pressure	in. (mm)	1-1/8 (28.58) Brazed	1-1/8 (28.58) Brazed		
Defrosting method		Auto-defrost mode (Reversed refrigerant cycle)				
Drawing	External	KL94R887				
	Wiring	KE94G651		KE94G651		
Standard attachment	Document	Installation Manual				
	Accessory	Details refer to External Drw				
Optional parts		Outdoor Twinning kit: CMY-R300NCBK joint: CMY-Y102SS-G2, CMY-Y102LS-G2, CMY-R160-J1 Main BC controller: CMB-P108, 1012, 1016NU-JA1, CMB-P1016NU-KA1 Sub BC controller: CMB-P104, 108NU-KB1				
Remarks		Details on foundation work, duct work, insulation work, electrical wiring, power source switch, and other items shall be referred to the Installation Manual.				

Notes:	Unit converter
1. Nominal cooling conditions (Test conditions are based on AHR1 1230) Indoor: 80°F D.B./67°F W.B. (26.7°C D.B./19.4°C W.B.), Outdoor: 95°F D.B. (35°C D.B.)	BTU/h = kW x 3,412
2. Nominal heating conditions (Test conditions are based on AHR1 1230) Indoor: 70°F D.B. (21.1°C D.B.), Outdoor: 47°F D.B./43°F W.B. (8.3°C D.B./6.1°C W.B.)	cfm = m ³ /min x 35.31
3. Cooling mode/Heating mode	lbs = kg/0.4536
4. External static pressure option is available (0.12 in.WG, 0.24 in.WG, 0.32 in.WG/30 Pa, 60 Pa, 80 Pa).	
* Due to continuing improvement, above specifications may be subject to change without notice.	*Above specification data is subject to rounding variation.

1. SPECIFICATIONS

R2-Series (High efficiency)

PURY-EP-T(S)NU-A, Y(S)NU-A

Outdoor Model			PURY-EP384YSNU-A (-BS)		
Indoor Model			Non-Ducted	Ducted	
Power source			3-phase 3-wire 460 V ±10% 60 Hz		
Cooling capacity (Nominal)	*1	BTU/h	384,000		
		kW	112.5		
	(460)	Power input	kW	36.62	
		Current input	A	51.0	
	(Rated)	BTU/h	364,000		
		kW	106.7		
	(460)	Power input	kW	34.40	32.73
		Current input	A	47.9	45.6
Temp. range of cooling	Indoor	W.B.	59~75°F (15~24°C)		
	Outdoor	D.B.	23~126°F (-5~52°C)		
Heating capacity (Nominal)	*2	BTU/h	430,000		
		kW	126.0		
	(460)	Power input	kW	38.66	
		Current input	A	53.9	
	(Rated)	BTU/h	410,000		
		kW	120.2		
	(460)	Power input	kW	36.47	35.13
		Current input	A	50.8	48.9
Temp. range of heating	Indoor	D.B.	59~81°F (15~27°C)		
	Outdoor	W.B.	-13~60°F (-25~15.5°C)		
Indoor unit connectable	Total capacity	50~150% of outdoor unit capacity			
	Model/Quantity	P04-P96/2~50			
Sound power level (measured in anechoic room) *3	dB <A>	86.5/89.0			
Refrigerant piping diameter	High pressure	in. (mm)	1-1/8 (28.58) Brazed		
	Low pressure	in. (mm)	1-5/8 (41.28) Brazed		

Set Model			PURY-EP192YNU-A(-BS)		PURY-EP192YNU-A(-BS)	
Model			PURY-EP192YNU-A(-BS)		PURY-EP192YNU-A(-BS)	
Minimum Circuit Ampacity	A		38		38	
Maximum Overcurrent Protection	A		60		60	
FAN	Type x Quantity	Propeller fan x 2		Propeller fan x 2		
	Airflow rate	cfm	13,050		13,050	
		m ³ /min	370		370	
		L/s	6,170		6,170	
	Control, Driving mechanism	Inverter-control, Brushless DC motor		Inverter-control, Brushless DC motor		
	Motor output	kW	0.92+0.92		0.92+0.92	
External static press.	0 in.WG (0 Pa)		0 in.WG (0 Pa)			
Compressor	Type x Quantity	Inverter scroll hermetic compressor x 1		Inverter scroll hermetic compressor x 1		
	Starting method	Inverter		Inverter		
	Motor output	kW	13.2		13.2	
	Case heater	kW	-		-	
	Lubricant	MEL32		MEL32		
External finish	Pre-coated galvanized steel sheet (+powder coating for -BS type) <MUNSELL 5Y 8/1>		Pre-coated galvanized steel sheet (+powder coating for -BS type) <MUNSELL 5Y 8/1>			
External dimension H x W x D	in.	71-5/8 x 68-15/16 x 29-3/16		71-5/8 x 68-15/16 x 29-3/16		
	mm	1,818 x 1,750 x 740		1,818 x 1,750 x 740		
Protection devices	High pressure protection	High pressure sensor, High pressure switch at 4.15 MPa (601 psi)		High pressure sensor, High pressure switch at 4.15 MPa (601 psi)		
	Inverter circuit (COMP./FAN)	Over-current protection		Over-current protection		
	Fan motor	-		-		
Refrigerant	Type x original charge	R410A x 26 lbs + 1 oz (11.8 kg)		R410A x 26 lbs + 1 oz (11.8 kg)		
	Control	Indoor LEV and BC controller				
Net weight	lbs (kg)	918 (416)		918 (416)		
Heat exchanger	Salt-resistant cross fin & aluminium tube		Salt-resistant cross fin & aluminium tube			
HIC circuit (HIC: Heat Inter-Changer)	-		-			
Pipe between unit and distributor	High pressure	in. (mm)	7/8 (22.2) Brazed		7/8 (22.2) Brazed	
	Low pressure	in. (mm)	1-1/8 (28.58) Brazed		1-1/8 (28.58) Brazed	
Defrosting method	Auto-defrost mode (Reversed refrigerant cycle)					
Drawing	External	KB94C1J7		KB94C1J7		
	Wiring	KE94G983		KE94G983		
Standard attachment	Document	Installation Manual				
	Accessory	Details refer to External Drw				
Optional parts	Outdoor Twinning kit: CMY-R300NCBK joint: CMY-Y102SS-G2, CMY-Y102LS-G2, CMY-R160-J1 Main BC controller: CMB-P1016NU-KA1 Sub BC controller: CMB-P104, 108NU-KB1					
Remarks	Details on foundation work, duct work, insulation work, electrical wiring, power source switch, and other items shall be referred to the Installation Manual.					

Notes:	Unit converter
1.Nominal cooling conditions (Test conditions are based on AHRI 1230) Indoor: 80°F D.B./67°F W.B. (26.7°C D.B./19.4°C W.B.), Outdoor: 95°F D.B. (35°C D.B.)	BTU/h = kW x 3,412
2.Nominal heating conditions (Test conditions are based on AHRI 1230) Indoor: 70°F D.B. (21.1°C D.B.), Outdoor: 47°F D.B./43°F W.B. (8.3°C D.B./6.1°C W.B.)	cfm = m ³ /min x 35.31
3.Cooling mode/Heating mode	lbs = kg/0.4536
4.External static pressure option is available (0.12 in.WG, 0.24 in.WG, 0.32 in.WG/30 Pa, 60 Pa, 80 Pa).	
* Due to continuing improvement, above specifications may be subject to change without notice.	*Above specification data is subject to rounding variation.

1. SPECIFICATIONS

R2-Series (High efficiency)

PURY-EP-T(S)NU-A, Y(S)NU-A

Outdoor Model		PURY-EP432YSNU-A (-BS)		
Indoor Model		Non-Ducted	Ducted	
Power source		3-phase 3-wire 460 V ±10% 60 Hz		
Cooling capacity (Nominal)	*1	BTU/h	432,000	
		kW	126.6	
	(460)	Power input	42.36	
		Current input	59.0	
	(Rated)		BTU/h	410,000
			kW	120.2
(460)	Power input	39.58	38.09	
	Current input	55.1	53.1	
Temp. range of cooling	Indoor	W.B.	59~75°F (15~24°C)	
	Outdoor	D.B.	23~126°F (-5~52°C)	
Heating capacity (Nominal)	*2	BTU/h	480,000	
		kW	140.7	
	(460)	Power input	43.14	
		Current input	60.1	
	(Rated)		BTU/h	455,000
			kW	133.4
(460)	Power input	40.70	38.91	
	Current input	56.7	54.2	
Temp. range of heating	Indoor	D.B.	59~81°F (15~27°C)	
	Outdoor	W.B.	-13~60°F (-25~15.5°C)	
Indoor unit connectable	Total capacity	50~150% of outdoor unit capacity		
	Model/Quantity	P04-P96/2-50		
Sound power level (measured in anechoic room) *3		dB <A> 89.0/89.0		
Refrigerant piping diameter	High pressure	in. (mm) 1-1/8 (28.58) Brazed		
	Low pressure	in. (mm) 1-5/8 (41.28) Brazed		

Set Model				
Model		PURY-EP216YNU-A(-BS)	PURY-EP216YNU-A(-BS)	
Minimum Circuit Ampacity		A	41	
Maximum Overcurrent Protection		A	70	
FAN	Type x Quantity	Propeller fan x 2		
	Airflow rate	cfm	14,100	
		m ³ /min	400	
		L/s	6,670	
	Control, Driving mechanism		Inverter-control, Brushless DC motor	
	Motor output	kW	0.92+0.92	0.92+0.92
*4 External static press.		0 in.WG (0 Pa)		
Compressor	Type x Quantity	Inverter scroll hermetic compressor x 1		
	Starting method		Inverter	
	Motor output	kW	15.8	
	Case heater	kW	-	
	Lubricant		MEL32	
External finish		Pre-coated galvanized steel sheet (+powder coating for -BS type) <MUNSELL 5Y 8/1>		
External dimension H x W x D	in.	71-5/8 x 68-15/16 x 29-3/16		
	mm	1,818 x 1,750 x 740		
Protection devices	High pressure protection		High pressure sensor, High pressure switch at 4.15 MPa (601 psi)	
	Inverter circuit (COMP./FAN)		Over-current protection	
	Fan motor		-	
Refrigerant	Type x original charge	R410A x 26 lbs + 1 oz (11.8 kg)		
	Control		Indoor LEV and BC controller	
Net weight	lbs (kg)	918 (416)		
Heat exchanger		Salt-resistant cross fin & aluminium tube		
HIC circuit (HIC: Heat Inter-Changer)		-		
Pipe between unit and distributor	High pressure	in. (mm) 7/8 (22.2) Brazed		
	Low pressure	in. (mm) 1-1/8 (28.58) Brazed		
Defrosting method		Auto-defrost mode (Reversed refrigerant cycle)		
Drawing	External	KB94C1J7		
	Wiring	KE94G983	KE94G983	
Standard attachment	Document	Installation Manual		
	Accessory	Details refer to External Drw		
Optional parts		Outdoor Twinning kit: CMY-R300NCBK joint: CMY-Y102SS-G2, CMY-Y102LS-G2, CMY-R160-J1 Main BC controller: CMB-P1016NU-KA1 Sub BC controller: CMB-P104, 108NU-KB1		
Remarks		Details on foundation work, duct work, insulation work, electrical wiring, power source switch, and other items shall be referred to the Installation Manual.		

Notes:	Unit converter
1. Nominal cooling conditions (Test conditions are based on AHRI 1230) Indoor: 80°F D.B./67°F W.B. (26.7°C D.B./19.4°C W.B.), Outdoor: 95°F D.B. (35°C D.B.)	BTU/h = kW x 3,412
2. Nominal heating conditions (Test conditions are based on AHRI 1230) Indoor: 70°F D.B. (21.1°C D.B.), Outdoor: 47°F D.B./43°F W.B. (8.3°C D.B./6.1°C W.B.)	cfm = m ³ /min x 35.31
3. Cooling mode/Heating mode	lbs = kg/0.4536
4. External static pressure option is available (0.12 in.WG, 0.24 in.WG, 0.32 in.WG/30 Pa, 60 Pa, 80 Pa).	
* Due to continuing improvement, above specifications may be subject to change without notice.	*Above specification data is subject to rounding variation.

PURY-EP-T(S)NU-A, Y(S)NU-A

1-2. AHRI 1230-2021 condition

Outdoor Model		PURY-EP72TNU-A (-BS)		
Indoor Model		Non-Ducted	Ducted	
Power source		3-phase 3-wire 208-230V±10% 60Hz		
Cooling capacity (Nominal)	*1	BTU/h	72,000	
		kW	21.1	
	(208-230)	Power input	kW	
		Current input	A	
	(Rated)	BTU/h	69,000	
		kW	20.2	
	(208-230)	Power input	5.40	5.45
		Current input	16.6-15.0	16.8-15.2
Temp. range of cooling	Indoor	W.B.	59~75°F (15~24°C)	
	Outdoor	D.B.	23~126°F (-5~52°C)	
Heating capacity (Nominal)	*2	BTU/h	80,000	
		kW	23.4	
	(208-230)	Power input	kW	
		Current input	A	
	(Rated)	BTU/h	76,000	
		kW	22.3	
	(208-230)	Power input	4.77	5.28
		Current input	14.7-13.3	16.2-14.7
Temp. range of heating	Indoor	D.B.	59~81°F (15~27°C)	
	Outdoor	W.B.	-13~60°F (-25~15.5°C)	
Indoor unit connectable	Total capacity	50~150% of outdoor unit capacity		
	Model/Quantity	P04~P96/1~18		
Sound power level (measured in anechoic room)	*3	dB <A>	75.5/77.0	
Refrigerant piping diameter	High pressure	in. (mm)	5/8 (15.88) Brazed	
	Low pressure	in. (mm)	3/4 (19.05) Brazed	
Minimum Circuit Ampacity		A	33-30	
Maximum Overcurrent Protection		A	50-50	
FAN	Type x Quantity		Propeller fan x 1	
	Airflow rate	cfm	6,000	
		m ³ /min	170	
		L/s	2,830	
	Control, Driving mechanism		Inverter-control, Brushless DC motor	
	Motor output	kW	0.92	
*4	External static press.		0 in.WG (0 Pa)	
Compressor	Type x Quantity		Inverter scroll hermetic compressor x 1	
	Starting method		Inverter	
	Motor output	kW	3.8	
	Case heater	kW	-	
	Lubricant		MEL32	
External finish		Pre-coated galvanized steel sheet (+powder coating for -BS type) <MUNSELL 5Y 8/1>		
External dimension H x W x D	in.	71-5/8 x 36-1/4 x 29-3/16		
	mm	1,818 x 920 x 740		
Protection devices	High pressure protection		High pressure sensor, High pressure switch at 4.15 MPa (601 psi)	
	Inverter circuit (COMP./FAN)		Over-current protection	
	Compressor		-	
	Fan motor		-	
Refrigerant	Type x original charge		R410A x 11 lbs + 7 oz (5.2 kg)	
	Control		Indoor LEV and BC controller	
Net weight	lbs (kg)	519 (235)		
Heat exchanger		Salt-resistant cross fin & aluminium tube		
HIC circuit (HIC: Heat Inter-Changer)		-		
Defrosting method		Auto-defrost mode (Reversed refrigerant cycle)		
Drawing	External	KL94R876		
	Wiring	KE94G672		
Standard attachment	Document	Installation Manual		
	Accessory	Details refer to External Drw		
Optional parts		joint: CMY-Y102SS-G2,CMY-Y102LS-G2,CMY-R160-J1 BC controller: CMB-P104,106,108,1012,1016NU-J1 Main BC controller: CMB-P108,1012,1016NU-JA1,CMB-P1016NU-KA1 Sub BC controller: CMB-P104,108NU-KB1		
Remarks		Details on foundation work, duct work, insulation work, electrical wiring, power source switch, and other items shall be referred to the Installation Manual.		

Notes:	Unit converter
1.Nominal cooling conditions (Test conditions are based on AHRI 1230) Indoor: 80°F D.B./67°F W.B. (26.7°C D.B./19.4°C W.B.), Outdoor: 95°F D.B. (35°C D.B.)	BTU/h =kW x 3,412
2.Nominal heating conditions (Test conditions are based on AHRI 1230) Indoor: 70°F D.B. (21.1°C D.B.), Outdoor: 47°F D.B./43°F W.B. (8.3°C D.B./6.1°C W.B.)	cfm =m ³ /min x 35.31
3.Cooling mode/Heating mode	lbs =kg/0.4536
4.External static pressure option is available (0.12 in.WG, 0.24 in.WG, 0.32 in.WG/30 Pa, 60 Pa, 80 Pa).	*Above specification data is subject to rounding variation.
Due to continuing improvement, above specifications may be subject to change without notice.	

1. SPECIFICATIONS

R2-Series (High efficiency)

Outdoor Model		PURY-EP96TNU-A (-BS)		
Indoor Model		Non-Ducted	Ducted	
Power source		3-phase 3-wire 208-230V±10% 60Hz		
Cooling capacity (Nominal)	*1	BTU/h	96,000	
		kW	28.1	
	(208-230)	Power input	6.11	
		Current input	18.8-17.0	
	(Rated)	BTU/h	92,000	
		kW	27.0	
	(208-230)	Power input	7.36	7.40
		Current input	22.6-20.5	22.8-20.6
Temp. range of cooling	Indoor	W.B.	59~75°F (15~24°C)	
	Outdoor	D.B.	23~126°F (-5~52°C)	
Heating capacity (Nominal)	*2	BTU/h	108,000	
		kW	31.7	
	(208-230)	Power input	7.40	
		Current input	22.8-20.6	
	(Rated)	BTU/h	103,000	
		kW	30.2	
	(208-230)	Power input	6.72	6.90
		Current input	20.7-18.7	21.2-19.2
Temp. range of heating	Indoor	D.B.	59~81°F (15~27°C)	
	Outdoor	W.B.	-13~60°F (-25~15.5°C)	
Indoor unit connectable	Total capacity	50~150% of outdoor unit capacity		
	Model/Quantity	P04~P96/1~24		
Sound power level (measured in anechoic room)	*3	dB <A>	77.5/79.0	
Refrigerant piping diameter	High pressure	in. (mm)	3/4 (19.05) Brazed	
	Low pressure	in. (mm)	7/8 (22.2) Brazed	
Minimum Circuit Ampacity	A		44-40	
Maximum Overcurrent Protection	A		70-60	
FAN	Type x Quantity		Propeller fan x 2	
	Airflow rate	cfm	7,400	
		m ³ /min	210	
		L/s	3,500	
	Control, Driving mechanism		Inverter-control, Brushless DC motor	
	Motor output	kW	0.46+0.46	
*4	External static press.		0 in.WG (0 Pa)	
Compressor	Type x Quantity		Inverter scroll hermetic compressor x 1	
	Starting method		Inverter	
	Motor output	kW	5.5	
	Case heater	kW	-	
	Lubricant		MEL32	
External finish		Pre-coated galvanized steel sheet (+powder coating for -BS type) <MUNSELL 5Y 8/1>		
External dimension H x W x D	in.	71-5/8 x 48-7/8 x 29-3/16		
	mm	1,818 x 1,240 x 740		
Protection devices	High pressure protection		High pressure sensor, High pressure switch at 4.15 MPa (601 psi)	
	Inverter circuit (COMP./FAN)		Over-current protection	
	Compressor		-	
	Fan motor		-	
Refrigerant	Type x original charge		R410A x 17 lbs + 10 oz (8.0 kg)	
	Control		Indoor LEV and BC controller	
Net weight	lbs (kg)	613 (278)		
Heat exchanger		Salt-resistant cross fin & aluminium tube		
HIC circuit (HIC: Heat Inter-Changer)		-		
Defrosting method		Auto-defrost mode (Reversed refrigerant cycle)		
Drawing	External	KL94R877		
	Wiring	KE94G655		
Standard attachment	Document	Installation Manual		
	Accessory	Details refer to External Drw		
Optional parts		joint: CMY-Y102SS-G2, CMY-Y102LS-G2, CMY-R160-J1 BC controller: CMB-P104, 106, 108, 1012, 1016NU-J1 Main BC controller: CMB-P108, 1012, 1016NU-JA1, CMB-P1016NU-KA1 Sub BC controller: CMB-P104, 108NU-KB1		
Remarks		Details on foundation work, duct work, insulation work, electrical wiring, power source switch, and other items shall be referred to the Installation Manual.		

Notes:	Unit converter
1. Nominal cooling conditions (Test conditions are based on AHRI 1230) Indoor: 80°F D.B./67°F W.B. (26.7°C D.B./19.4°C W.B.), Outdoor: 95°F D.B. (35°C D.B.)	BTU/h = kW x 3,412
2. Nominal heating conditions (Test conditions are based on AHRI 1230) Indoor: 70°F D.B. (21.1°C D.B.), Outdoor: 47°F D.B./43°F W.B. (8.3°C D.B./6.1°C W.B.)	cfm = m ³ /min x 35.31
3. Cooling mode/Heating mode	lbs = kg/0.4536
4. External static pressure option is available (0.12 in.WG, 0.24 in.WG, 0.32 in.WG/30 Pa, 60 Pa, 80 Pa).	
Due to continuing improvement, above specifications may be subject to change without notice.	*Above specification data is subject to rounding variation.

1. SPECIFICATIONS

R2-Series (High efficiency)

PURY-EP-T(S)NU-A, Y(S)NU-A

Outdoor Model		PURY-EP120TNU-A (-BS)		
Indoor Model		Non-Ducted	Ducted	
Power source		3-phase 3-wire 208-230V±10% 60Hz		
Cooling capacity (Nominal)	*1	BTU/h	120,000	
		kW	35.2	
	(208-230)	Power input	kW	8.43
		Current input	A	25.9-23.5
	(Rated)		BTU/h	115,000
			kW	33.7
(208-230)	Power input	kW	10.55	
	Current input	A	32.5-29.4	
Temp. range of cooling	Indoor	W.B.	59~75°F (15~24°C)	
	Outdoor	D.B.	23~126°F (-5~52°C)	
Heating capacity (Nominal)	*2	BTU/h	135,000	
		kW	39.6	
	(208-230)	Power input	kW	9.89
		Current input	A	30.5-27.5
	(Rated)		BTU/h	129,000
			kW	37.8
(208-230)	Power input	kW	8.95	
	Current input	A	27.6-24.9	
Temp. range of heating	Indoor	D.B.	59~81°F (15~27°C)	
	Outdoor	W.B.	-13~60°F (-25~15.5°C)	
Indoor unit connectable	Total capacity	50~150% of outdoor unit capacity		
	Model/Quantity	P04~P96/1~30		
Sound power level (measured in anechoic room)		*3	dB <A>	
		80.5/80.5		
Refrigerant piping diameter	High pressure	in. (mm)	3/4 (19.05) Brazed	
	Low pressure	in. (mm)	1-1/8 (28.58) Brazed	
Minimum Circuit Ampacity		A	56-55	
Maximum Overcurrent Protection		A	90-90	
FAN	Type x Quantity		Propeller fan x 2	
	Airflow rate	cfm	8,300	
		m ³ /min	235	
		L/s	3,920	
	Control, Driving mechanism		Inverter-control, Brushless DC motor	
	Motor output	kW	0.46+0.46	
*4	External static press.		0 in.WG (0 Pa)	
Compressor	Type x Quantity		Inverter scroll hermetic compressor x 1	
	Starting method		Inverter	
	Motor output	kW	7.6	
	Case heater	kW	-	
	Lubricant		MEL32	
External finish		Pre-coated galvanized steel sheet (+powder coating for -BS type) <MUNSELL 5Y 8/1>		
External dimension H x W x D		in.	71-5/8 x 48-7/8 x 29-3/16	
		mm	1,818 x 1,240 x 740	
Protection devices	High pressure protection		High pressure sensor, High pressure switch at 4.15 MPa (601 psi)	
	Inverter circuit (COMP./FAN)		Over-current protection	
	Compressor		-	
	Fan motor		-	
Refrigerant	Type x original charge		R410A x 17 lbs + 10 oz (8.0 kg)	
	Control		Indoor LEV and BC controller	
Net weight	lbs (kg)	622 (282)		
Heat exchanger		Salt-resistant cross fin & aluminium tube		
HIC circuit (HIC: Heat Inter-Changer)		-		
Defrosting method		Auto-defrost mode (Reversed refrigerant cycle)		
Drawing	External	KL94R877		
	Wiring	KE94G655		
Standard attachment	Document	Installation Manual		
	Accessory	Details refer to External Drw		
Optional parts		joint: CMY-Y102SS-G2, CMY-Y102LS-G2, CMY-R160-J1 BC controller: CMB-P104, 106, 108, 1012, 1016NU-J1 Main BC controller: CMB-P108, 1012, 1016NU-JA1, CMB-P1016NU-KA1 Sub BC controller: CMB-P104, 108NU-KB1		
Remarks		Details on foundation work, duct work, insulation work, electrical wiring, power source switch, and other items shall be referred to the Installation Manual.		

Notes:	Unit converter
1. Nominal cooling conditions (Test conditions are based on AHRI 1230) Indoor: 80°F D.B./67°F W.B. (26.7°C D.B./19.4°C W.B.), Outdoor: 95°F D.B. (35°C D.B.)	BTU/h =kW x 3,412
2. Nominal heating conditions (Test conditions are based on AHRI 1230) Indoor: 70°F D.B. (21.1°C D.B.), Outdoor: 47°F D.B./43°F W.B. (8.3°C D.B./6.1°C W.B.)	cfm =m ³ /min x 35.31
3. Cooling mode/Heating mode	lbs =kg/0.4536
4. External static pressure option is available (0.12 in.WG, 0.24 in.WG, 0.32 in.WG/30 Pa, 60 Pa, 80 Pa).	
Due to continuing improvement, above specifications may be subject to change without notice.	*Above specification data is subject to rounding variation.

1. SPECIFICATIONS

R2-Series (High efficiency)

PURY-EP-T(S)NU-A, Y(S)NU-A

Outdoor Model		PURY-EP144TNU-A (-BS)		
Indoor Model		Non-Ducted	Ducted	
Power source		3-phase 3-wire 208-230V±10% 60Hz		
Cooling capacity (Nominal)	*1	BTU/h	144,000	
		kW	42.2	
	(208-230)	Power input	11.03	
		Current input	34.0-30.7	
	(Rated)	BTU/h	138,000	
		kW	40.4	
	(208-230)	Power input	13.30	13.10
		Current input	41.0-37.0	40.4-36.5
Temp. range of cooling	Indoor	W.B.	59~75°F (15~24°C)	
	Outdoor	D.B.	23~126°F (-5~52°C)	
Heating capacity (Nominal)	*2	BTU/h	160,000	
		kW	46.9	
	(208-230)	Power input	12.34	
		Current input	38.0-34.4	
	(Rated)	BTU/h	152,000	
		kW	44.5	
	(208-230)	Power input	11.08	11.60
		Current input	34.1-30.9	35.7-32.3
Temp. range of heating	Indoor	D.B.	59~81°F (15~27°C)	
	Outdoor	W.B.	-13~60°F (-25~15.5°C)	
Indoor unit connectable	Total capacity	50~150% of outdoor unit capacity		
	Model/Quantity	P04~P96/1~36		
Sound power level (measured in anechoic room)	*3	dB <A>	85.5/85.5	
Refrigerant piping diameter	High pressure	in. (mm)	7/8 (22.2) Brazed	
	Low pressure	in. (mm)	1-1/8 (28.58) Brazed	
Minimum Circuit Ampacity			A	
Maximum Overcurrent Protection			A	
FAN	Type x Quantity		Propeller fan x 2	
	Airflow rate	cfm	9,550	
		m ³ /min	270	
		L/s	4,500	
	Control, Driving mechanism		Inverter-control, Brushless DC motor	
	Motor output	kW	0.46+0.46	
*4	External static press.		0 in.WG (0 Pa)	
Compressor	Type x Quantity		Inverter scroll hermetic compressor x 1	
	Starting method		Inverter	
	Motor output	kW	9.8	
	Case heater	kW	-	
	Lubricant		MEL32	
External finish		Pre-coated galvanized steel sheet (+powder coating for -BS type) <MUNSELL 5Y 8/1>		
External dimension H x W x D		in.	71-5/8 x 48-7/8 x 29-3/16	
		mm	1,818 x 1,240 x 740	
Protection devices	High pressure protection		High pressure sensor, High pressure switch at 4.15 MPa (601 psi)	
	Inverter circuit (COMP./FAN)		Over-current protection	
	Compressor		-	
	Fan motor		-	
Refrigerant	Type x original charge		R410A x 23 lbs + 12 oz (10.8 kg)	
	Control		Indoor LEV and BC controller	
Net weight	lbs (kg)	680 (308)		
Heat exchanger		Salt-resistant cross fin & aluminium tube		
HIC circuit (HIC: Heat Inter-Changer)		-		
Defrosting method		Auto-defrost mode (Reversed refrigerant cycle)		
Drawing	External		KL94R877	
	Wiring		KE94G655	
Standard attachment	Document		Installation Manual	
	Accessory		Details refer to External Drw	
Optional parts		joint: CMY-Y102SS-G2, CMY-Y102LS-G2, CMY-R160-J1 Main BC controller: CMB-P108, 1012, 1016NU-JA1, CMB-P1016NU-KA1 Sub BC controller: CMB-P104, 108NU-KB1		
Remarks		Details on foundation work, duct work, insulation work, electrical wiring, power source switch, and other items shall be referred to the Installation Manual.		

Notes:	Unit converter
1. Nominal cooling conditions (Test conditions are based on AHRI 1230) Indoor: 80°F D.B./67°F W.B. (26.7°C D.B./19.4°C W.B.), Outdoor: 95°F D.B. (35°C D.B.)	BTU/h = kW x 3,412
2. Nominal heating conditions (Test conditions are based on AHRI 1230) Indoor: 70°F D.B. (21.1°C D.B.), Outdoor: 47°F D.B./43°F W.B. (8.3°C D.B./6.1°C W.B.)	cfm = m ³ /min x 35.31
3. Cooling mode/Heating mode	lbs = kg/0.4536
4. External static pressure option is available (0.12 in.WG, 0.24 in.WG, 0.32 in.WG/30 Pa, 60 Pa, 80 Pa).	
Due to continuing improvement, above specifications may be subject to change without notice.	*Above specification data is subject to rounding variation.

1. SPECIFICATIONS

R2-Series (High efficiency)

PURY-EP-T(S)NU-A, Y(S)NU-A

Outdoor Model		PURY-EP168TNU-A (-BS)		
Indoor Model		Non-Ducted	Ducted	
Power source		3-phase 3-wire 208-230V±10% 60Hz		
Cooling capacity (Nominal)	*1	BTU/h	168,000	
		kW	49.2	
	(208-230)	Power input	kW	
		Current input	A	
	(Rated)	BTU/h	43.1-39.0	
		kW	160,000	
(208-230)	Power input	kW	15.40	
	Current input	A	47.4-42.9	
Temp. range of cooling	Indoor	W.B.	59~75°F (15~24°C)	
	Outdoor	D.B.	23~126°F (-5~52°C)	
Heating capacity (Nominal)	*2	BTU/h	188,000	
		kW	55.1	
	(208-230)	Power input	kW	
		Current input	A	
	(Rated)	BTU/h	46.7-42.3	
		kW	178,000	
(208-230)	Power input	kW	13.23	
	Current input	A	40.8-36.9	
Temp. range of heating	Indoor	D.B.	59~81°F (15~27°C)	
	Outdoor	W.B.	-13~60°F (-25~15.5°C)	
Indoor unit connectable	Total capacity	50~150% of outdoor unit capacity		
	Model/Quantity	P04~P96/1~42		
Sound power level (measured in anechoic room) *3		dB <A>	81.5/85.5	
Refrigerant piping diameter	High pressure	in. (mm)	7/8 (22.2) Brazed	
	Low pressure	in. (mm)	1-1/8 (28.58) Brazed	
Minimum Circuit Ampacity		A	70-70	
Maximum Overcurrent Protection		A	110-110	
FAN	Type x Quantity		Propeller fan x 2	
	Airflow rate	cfm	14,850	
		m ³ /min	420	
		L/s	7,000	
	Control, Driving mechanism		Inverter-control, Brushless DC motor	
	Motor output	kW	0.92+0.92	
*4	External static press.		0 in.WG (0 Pa)	
Compressor	Type x Quantity		Inverter scroll hermetic compressor x 1	
	Starting method		Inverter	
	Motor output	kW	12.2	
	Case heater	kW	-	
	Lubricant		MEL32	
External finish		Pre-coated galvanized steel sheet (+powder coating for -BS type) <MUNSELL 5Y 8/1>		
External dimension H x W x D	in.	71-5/8 x 68-15/16 x 29-3/16		
	mm	1,818 x 1,750 x 740		
Protection devices	High pressure protection		High pressure sensor, High pressure switch at 4.15 MPa (601 psi)	
	Inverter circuit (COMP./FAN)		Over-current protection	
	Compressor		-	
	Fan motor		-	
Refrigerant	Type x original charge		R410A x 23 lbs + 12 oz (10.8 kg)	
	Control		Indoor LEV and BC controller	
Net weight	lbs (kg)	777 (352)		
Heat exchanger		Salt-resistant cross fin & aluminium tube		
HIC circuit (HIC: Heat Inter-Changer)		-		
Defrosting method		Auto-defrost mode (Reversed refrigerant cycle)		
Drawing	External	KL94R878		
	Wiring	KE94G654		
Standard attachment	Document	Installation Manual		
	Accessory	Details refer to External Drw		
Optional parts		joint: CMY-Y102SS-G2, CMY-Y102LS-G2, CMY-R160-J1 Main BC controller: CMB-P108, 1012, 1016NU-JA1, CMB-P1016NU-KA1 Sub BC controller: CMB-P104, 108NU-KB1		
Remarks		Details on foundation work, duct work, insulation work, electrical wiring, power source switch, and other items shall be referred to the Installation Manual.		

Notes:	Unit converter
1. Nominal cooling conditions (Test conditions are based on AHRI 1230) Indoor: 80°F D.B./67°F W.B. (26.7°C D.B./19.4°C W.B.), Outdoor: 95°F D.B. (35°C D.B.)	BTU/h = kW x 3,412
2. Nominal heating conditions (Test conditions are based on AHRI 1230) Indoor: 70°F D.B. (21.1°C D.B.), Outdoor: 47°F D.B./43°F W.B. (8.3°C D.B./6.1°C W.B.)	cfm = m ³ /min x 35.31
3. Cooling mode/Heating mode	lbs = kg/0.4536
4. External static pressure option is available (0.12 in.WG, 0.24 in.WG, 0.32 in.WG/30 Pa, 60 Pa, 80 Pa).	
Due to continuing improvement, above specifications may be subject to change without notice.	*Above specification data is subject to rounding variation.

1. SPECIFICATIONS

R2-Series (High efficiency)

Outdoor Model		PURY-EP192TNU-A (-BS)		
Indoor Model		Non-Ducted	Ducted	
Power source		3-phase 3-wire 208-230V±10% 60Hz		
Cooling capacity (Nominal)	*1	BTU/h	192,000	
		kW	56.3	
	(208-230)	Power input	15.65	
		Current input	48.2-43.6	
	(Rated)	BTU/h	184,000	
		kW	53.9	
	(208-230)	Power input	17.55	17.25
		Current input	54.1-48.9	53.2-48.1
Temp. range of cooling	Indoor	W.B.	59~75°F (15~24°C)	
	Outdoor	D.B.	23~126°F (-5~52°C)	
Heating capacity (Nominal)	*2	BTU/h	215,000	
		kW	63.0	
	(208-230)	Power input	17.54	
		Current input	54.0-48.9	
	(Rated)	BTU/h	204,000	
		kW	59.8	
	(208-230)	Power input	15.37	16.34
		Current input	47.4-42.8	50.3-45.5
Temp. range of heating	Indoor	D.B.	59~81°F (15~27°C)	
	Outdoor	W.B.	-13~60°F (-25~15.5°C)	
Indoor unit connectable	Total capacity	50~150% of outdoor unit capacity		
	Model/Quantity	P04~P96/1~48		
Sound power level (measured in anechoic room)	*3	dB <A>	83.5/85.0	
Refrigerant piping diameter	High pressure	in. (mm)	7/8 (22.2) Brazed	
	Low pressure	in. (mm)	1-1/8 (28.58) Brazed	
Minimum Circuit Ampacity			A 80-75	
Maximum Overcurrent Protection			A 125-125	
FAN	Type x Quantity		Propeller fan x 2	
	Airflow rate	cfm	13,050	
		m ³ /min	370	
		L/s	6,170	
	Control, Driving mechanism		Inverter-control, Brushless DC motor	
	Motor output	kW	0.92+0.92	
*4	External static press.		0 in.WG (0 Pa)	
Compressor	Type x Quantity		Inverter scroll hermetic compressor x 1	
	Starting method		Inverter	
	Motor output	kW	13.2	
	Case heater	kW	-	
	Lubricant		MEL32	
External finish		Pre-coated galvanized steel sheet (+powder coating for -BS type) <MUNSELL 5Y 8/1>		
External dimension H x W x D		in.	71-5/8 x 68-15/16 x 29-3/16	
		mm	1,818 x 1,750 x 740	
Protection devices	High pressure protection		High pressure sensor, High pressure switch at 4.15 MPa (601 psi)	
	Inverter circuit (COMP./FAN)		Over-current protection	
	Compressor		-	
	Fan motor		-	
Refrigerant	Type x original charge		R410A x 26 lbs + 1 oz (11.8 kg)	
	Control		Indoor LEV and BC controller	
Net weight	lbs (kg)	887 (402)		
Heat exchanger		Salt-resistant cross fin & aluminium tube		
HIC circuit (HIC: Heat Inter-Changer)		-		
Defrosting method		Auto-defrost mode (Reversed refrigerant cycle)		
Drawing	External		KB94C1J4	
	Wiring		KE94G984	
Standard attachment	Document		Installation Manual	
	Accessory		Details refer to External Drw	
Optional parts		joint: CMY-Y102SS-G2, CMY-Y102LS-G2, CMY-R160-J1 Main BC controller: CMB-P108, 1012, 1016NU-JA1, CMB-P1016NU-KA1 Sub BC controller: CMB-P104, 108NU-KB1		
Remarks		Details on foundation work, duct work, insulation work, electrical wiring, power source switch, and other items shall be referred to the Installation Manual.		

Notes:	Unit converter
1. Nominal cooling conditions (Test conditions are based on AHRI 1230) Indoor: 80°F D.B./67°F W.B. (26.7°C D.B./19.4°C W.B.), Outdoor: 95°F D.B. (35°C D.B.)	BTU/h = kW x 3,412
2. Nominal heating conditions (Test conditions are based on AHRI 1230) Indoor: 70°F D.B. (21.1°C D.B.), Outdoor: 47°F D.B./43°F W.B. (8.3°C D.B./6.1°C W.B.)	cfm = m ³ /min x 35.31
3. Cooling mode/Heating mode	lbs = kg/0.4536
4. External static pressure option is available (0.12 in.WG, 0.24 in.WG, 0.32 in.WG/30 Pa, 60 Pa, 80 Pa).	
Due to continuing improvement, above specifications may be subject to change without notice.	*Above specification data is subject to rounding variation.

1. SPECIFICATIONS

R2-Series (High efficiency)

PURY-EP-T(S)NU-A, Y(S)NU-A

Outdoor Model		PURY-EP216TNU-A (-BS)		
Indoor Model		Non-Ducted	Ducted	
Power source		3-phase 3-wire 208-230V±10% 60Hz		
Cooling capacity (Nominal)	*1	BTU/h	216,000	
		kW	63.3	
	(208-230)	Power input	18.66	
		Current input	57.5-52.0	
	(Rated)	BTU/h	206,000	
		kW	60.4	
(208-230)	Power input	20.50	20.35	
	Current input	63.2-57.1	62.7-56.7	
Temp. range of cooling	Indoor	W.B.	59~75°F (15~24°C)	
	Outdoor	D.B.	23~126°F (-5~52°C)	
Heating capacity (Nominal)	*2	BTU/h	243,000	
		kW	71.2	
	(208-230)	Power input	20.43	
		Current input	63.0-56.9	
	(Rated)	BTU/h	232,000	
		kW	68.0	
(208-230)	Power input	18.22	19.25	
	Current input	56.1-50.8	59.3-53.6	
Temp. range of heating	Indoor	D.B.	59~81°F (15~27°C)	
	Outdoor	W.B.	-13~60°F (-25~15.5°C)	
Indoor unit connectable	Total capacity	50~150% of outdoor unit capacity		
	Model/Quantity	P04~P96/2~50		
Sound power level (measured in anechoic room) *3		dB <A>	86.0/86.5	
Refrigerant piping diameter	High pressure	in. (mm)	7/8 (22.2) Brazed (1-1/8 (28.58) Brazed for the part that exceeds 65 m)	
	Low pressure	in. (mm)	1-3/8 (34.93) Brazed	
Minimum Circuit Ampacity		A	88-85	
Maximum Overcurrent Protection		A	150-150	
FAN	Type x Quantity		Propeller fan x 2	
	Airflow rate	cfm	14,100	
		m ³ /min	400	
		L/s	6,670	
	Control, Driving mechanism		Inverter-control, Brushless DC motor	
	Motor output	kW	0.92+0.92	
*4	External static press.		0 in.WG (0 Pa)	
Compressor	Type x Quantity		Inverter scroll hermetic compressor x 1	
	Starting method		Inverter	
	Motor output	kW	15.8	
	Case heater	kW	-	
	Lubricant		MEL32	
External finish		Pre-coated galvanized steel sheet (+powder coating for -BS type) <MUNSELL 5Y 8/1>		
External dimension H x W x D		in.	71-5/8 x 68-15/16 x 29-3/16	
		mm	1,818 x 1,750 x 740	
Protection devices	High pressure protection		High pressure sensor, High pressure switch at 4.15 MPa (601 psi)	
	Inverter circuit (COMP./FAN)		Over-current protection	
	Compressor		-	
	Fan motor		-	
Refrigerant	Type x original charge		R410A x 26 lbs + 1 oz (11.8 kg)	
	Control		Indoor LEV and BC controller	
Net weight	lbs (kg)	887 (402)		
Heat exchanger		Salt-resistant cross fin & aluminium tube		
HIC circuit (HIC: Heat Inter-Changer)		-		
Defrosting method		Auto-defrost mode (Reversed refrigerant cycle)		
Drawing	External		KB94C1J4	
	Wiring		KE94G984	
Standard attachment	Document		Installation Manual	
	Accessory		Details refer to External Drw	
Optional parts		joint: CMY-Y102SS-G2,CMY-Y102LS-G2,CMY-R160-J1 Main BC controller: CMB-P108,1012,1016NU-JA1,CMB-P1016NU-KA1 Sub BC controller: CMB-P104,108NU-KB1		
Remarks		Details on foundation work, duct work, insulation work, electrical wiring, power source switch, and other items shall be referred to the Installation Manual.		

Notes:	Unit converter
1. Nominal cooling conditions (Test conditions are based on AHRI 1230) Indoor: 80°F D.B./67°F W.B. (26.7°C D.B./19.4°C W.B.), Outdoor: 95°F D.B. (35°C D.B.)	BTU/h =kW x 3,412
2. Nominal heating conditions (Test conditions are based on AHRI 1230) Indoor: 70°F D.B. (21.1°C D.B.), Outdoor: 47°F D.B./43°F W.B. (8.3°C D.B./6.1°C W.B.)	cfm =m ³ /min x 35.31
3. Cooling mode/Heating mode	lbs =kg/0.4536
4. External static pressure option is available (0.12 in.WG, 0.24 in.WG, 0.32 in.WG/30 Pa, 60 Pa, 80 Pa).	
Due to continuing improvement, above specifications may be subject to change without notice.	*Above specification data is subject to rounding variation.

1. SPECIFICATIONS

R2-Series (High efficiency)

PURY-EP-T(S)NU-A, Y(S)NU-A

Outdoor Model		PURY-EP240TNU-A (-BS)		
Indoor Model		Non-Ducted	Ducted	
Power source		3-phase 3-wire 208-230V±10% 60Hz		
Cooling capacity (Nominal)	*1	BTU/h	224,000	
		kW	65.7	
	(208-230)	Power input	21.39	
		Current input	65.9-59.6	
	(Rated)	BTU/h	214,000	
		kW	62.7	
	(208-230)	Power input	21.60	21.00
		Current input	66.6-60.2	64.7-58.5
Temp. range of cooling	Indoor	W.B.	59~75°F (15~24°C)	
	Outdoor	D.B.	23~126°F (-5~52°C)	
Heating capacity (Nominal)	*2	BTU/h	250,000	
		kW	73.3	
	(208-230)	Power input	21.79	
		Current input	67.2-60.7	
	(Rated)	BTU/h	240,000	
		kW	70.3	
	(208-230)	Power input	19.96	20.20
		Current input	61.5-55.6	62.2-56.3
Temp. range of heating	Indoor	D.B.	59~81°F (15~27°C)	
	Outdoor	W.B.	-13~60°F (-25~15.5°C)	
Indoor unit connectable	Total capacity	50~150% of outdoor unit capacity		
	Model/Quantity	P04~P96/2~50		
Sound power level (measured in anechoic room)	*3	dB <A>	88.0/87.0	
Refrigerant piping diameter	High pressure	in. (mm)	7/8 (22.2) Brazed (1-1/8 (28.58) Brazed for the part that exceeds 65 m)	
	Low pressure	in. (mm)	1-3/8 (34.93) Brazed	
Minimum Circuit Ampacity	A		88-88	
Maximum Overcurrent Protection	A		150-150	
FAN	Type x Quantity		Propeller fan x 2	
	Airflow rate	cfm	14,500	
		m ³ /min	410	
		L/s	6,830	
	Control, Driving mechanism		Inverter-control, Brushless DC motor	
	Motor output	kW	0.92+0.92	
*4	External static press.		0 in.WG (0 Pa)	
Compressor	Type x Quantity		Inverter scroll hermetic compressor x 1	
	Starting method		Inverter	
	Motor output	kW	17.0	
	Case heater	kW	-	
	Lubricant		MEL32	
External finish		Pre-coated galvanized steel sheet (+powder coating for -BS type) <MUNSELL 5Y 8/1>		
External dimension H x W x D		in.	71-5/8 x 68-15/16 x 29-3/16	
		mm	1,818 x 1,750 x 740	
Protection devices	High pressure protection		High pressure sensor, High pressure switch at 4.15 MPa (601 psi)	
	Inverter circuit (COMP./FAN)		Over-current protection	
	Compressor		-	
	Fan motor		-	
Refrigerant	Type x original charge		R410A x 26 lbs + 1 oz (11.8 kg)	
	Control		Indoor LEV and BC controller	
Net weight	lbs (kg)		887 (402)	
Heat exchanger		Salt-resistant cross fin & aluminium tube		
HIC circuit (HIC: Heat Inter-Changer)		-		
Defrosting method		Auto-defrost mode (Reversed refrigerant cycle)		
Drawing	External		KB94C1J4	
	Wiring		KE94G984	
Standard attachment	Document		Installation Manual	
	Accessory		Details refer to External Drw	
Optional parts		joint: CMY-Y102SS-G2, CMY-Y102LS-G2, CMY-R160-J1 Main BC controller: CMB-P108, 1012, 1016NU-JA1, CMB-P1016NU-KA1 Sub BC controller: CMB-P104, 108NU-KB1		
Remarks		Details on foundation work, duct work, insulation work, electrical wiring, power source switch, and other items shall be referred to the Installation Manual.		

Notes:	Unit converter
1. Nominal cooling conditions (Test conditions are based on AHRI 1230) Indoor: 80°F D.B./67°F W.B. (26.7°C D.B./19.4°C W.B.), Outdoor: 95°F D.B. (35°C D.B.)	BTU/h = kW x 3,412
2. Nominal heating conditions (Test conditions are based on AHRI 1230) Indoor: 70°F D.B. (21.1°C D.B.), Outdoor: 47°F D.B./43°F W.B. (8.3°C D.B./6.1°C W.B.)	cfm = m ³ /min x 35.31
3. Cooling mode/Heating mode	lbs = kg/0.4536
4. External static pressure option is available (0.12 in.WG, 0.24 in.WG, 0.32 in.WG/30 Pa, 60 Pa, 80 Pa).	
Due to continuing improvement, above specifications may be subject to change without notice.	*Above specification data is subject to rounding variation.

1. SPECIFICATIONS

R2-Series (High efficiency)

PURY-EP-T(S)NU-A, Y(S)NU-A

Outdoor Model			PURY-EP192TSNU-A (-BS)			
Indoor Model			Non-Ducted		Ducted	
Power source			3-phase 3-wire 208-230V±10% 60Hz			
Cooling capacity (Nominal)	(208-230) (Rated)	*1	BTU/h	192,000		
			kW	56.3		
			Power input	kW	13.60	
			Current input	A	41.9-37.9	
	(208-230)			BTU/h	184,000	
				kW	53.9	
			Power input	kW	15.80	15.90
			Current input	A	48.7-44.0	49.0-44.3
Temp. range of cooling			Indoor	W.B. 59~75°F (15~24°C)		
			Outdoor	D.B. 23~126°F (-5~52°C)		
Heating capacity (Nominal)	(208-230) (Rated)	*2	BTU/h	215,000		
			kW	63.0		
			Power input	kW	16.02	
			Current input	A	49.4-44.6	
	(208-230)			BTU/h	204,000	
				kW	59.8	
			Power input	kW	14.46	14.75
			Current input	A	44.5-40.3	45.4-41.1
Temp. range of heating			Indoor	D.B. 59~81°F (15~27°C)		
			Outdoor	W.B. -13~60°F (-25~15.5°C)		
Indoor unit connectable			Total capacity 50~150% of outdoor unit capacity			
			Model/Quantity P04-P96/1-48			
Sound power level (measured in anechoic room)			*3	dB <A> 80.5/82.0		
Refrigerant piping diameter			High pressure	in. (mm) 7/8 (22.2) Brazed		
			Low pressure	in. (mm) 1-1/8 (28.58) Brazed		

Set Model			PURY-EP96TNU-A (-BS)		PURY-EP96TNU-A (-BS)	
Model			PURY-EP96TNU-A (-BS)		PURY-EP96TNU-A (-BS)	
Minimum Circuit Ampacity			A 44-40		44-40	
Maximum Overcurrent Protection			A 70-60		70-60	
FAN	Type x Quantity		Propeller fan x 2		Propeller fan x 2	
	Airflow rate	cfm	7400		7400	
		m ³ /min	210		210	
		L/s	3500		3500	
	Control, Driving mechanism		Inverter-control, Brushless DC motor		Inverter-control, Brushless DC motor	
	Motor output		kW 0.46+0.46		0.46+0.46	
Compressor	*4 External static press.		0 in.WG (0 Pa)		0 in.WG (0 Pa)	
	Type x Quantity		Inverter scroll hermetic compressor x 1		Inverter scroll hermetic compressor x 1	
	Starting method		Inverter		Inverter	
	Motor output		kW 5.5		5.5	
	Case heater		-		-	
	Lubricant		MEL32		MEL32	
External finish			Pre-coated galvanized steel sheet (+powder coating for -BS type) <MUNSELL 5Y 8/1>		Pre-coated galvanized steel sheet (+powder coating for -BS type) <MUNSELL 5Y 8/1>	
External dimension H x W x D			in. 71-5/8 x 48-7/8 x 29-3/16		71-5/8 x 48-7/8 x 29-3/16	
			mm 1,818 x 1,240 x 740		1,818 x 1,240 x 740	
Protection devices	High pressure protection		High pressure sensor, High pressure switch at 4.15 MPa (601 psi)		High pressure sensor, High pressure switch at 4.15 MPa (601 psi)	
	Inverter circuit (COMP./FAN)		Over-current protection		Over-current protection	
	Compressor		-		-	
	Fan motor		-		-	
Refrigerant			Type x original charge R410A x 17 lbs + 10 oz (8.0 kg)		R410A x 17 lbs + 10 oz (8.0 kg)	
			Control		Indoor LEV and BC controller	
Net weight			lbs (kg) 613 (278)		613 (278)	
Heat exchanger			Salt-resistant cross fin & aluminium tube		Salt-resistant cross fin & aluminium tube	
HIC circuit (HIC: Heat Inter-Changer)			-		-	
Pipe between unit and distributor	High pressure		in. (mm) 3/4 (19.05) Brazed		3/4 (19.05) Brazed	
	Low pressure		in. (mm) 7/8 (22.2) Brazed		7/8 (22.2) Brazed	
Defrosting method			Auto-defrost mode (Reversed refrigerant cycle)			
Drawing	External		KL94R879			
	Wiring		KE94G655		KE94G655	
Standard attachment	Document		Installation Manual			
	Accessory		Details refer to External Drw			
Optional parts			Outdoor Twinning kit: CMY-R200NCBK joint: CMY-Y102SS-G2, CMY-Y102LS-G2, CMY-R160-J1 Main BC controller: CMB-P108, 1012, 1016NU-JA1, CMB-P1016NU-KA1 Sub BC controller: CMB-P104, 108NU-KB1			
Remarks			Details on foundation work, duct work, insulation work, electrical wiring, power source switch, and other items shall be referred to the Installation Manual.			

Notes:	Unit converter
1.Nominal cooling conditions (Test conditions are based on AHRI 1230) Indoor: 80°F D.B./67°F W.B. (26.7°C D.B./19.4°C W.B.), Outdoor: 95°F D.B. (35°C D.B.)	BTU/h =kW x 3.412
2.Nominal heating conditions (Test conditions are based on AHRI 1230) Indoor: 70°F D.B. (21.1°C D.B.), Outdoor: 47°F D.B./43°F W.B. (8.3°C D.B./6.1°C W.B.)	cfm =m ³ /min x 35.31
3.Cooling mode/Heating mode	lbs =kg/0.4536
4.External static pressure option is available (0.12 in.WG, 0.24 in.WG, 0.32 in.WG/30 Pa, 60 Pa, 80 Pa).	
Due to continuing improvement, above specifications may be subject to change without notice.	*Above specification data is subject to rounding variation.

1. SPECIFICATIONS

R2-Series (High efficiency)

PURY-EP-T(S)NU-A, Y(S)NU-A

Outdoor Model			PURY-EP216T(S)NU-A (-BS)		
Indoor Model			Non-Ducted		Ducted
Power source			3-phase 3-wire 208-230V±10% 60Hz		
Cooling capacity (Nominal)	*1	BTU/h	216,000		
		kW	63.3		
	(208-230)	Power input	16.06		
		Current input	49.5-44.7		
	(Rated)	BTU/h	206,000		
		kW	60.4		
(208-230)	Power input	19.00		19.10	
	Current input	58.5-52.9		58.9-53.2	
Temp. range of cooling	Indoor	W.B.	59~75°F (15~24°C)		
	Outdoor	D.B.	23~126°F (-5~52°C)		
Heating capacity (Nominal)	*2	BTU/h	243,000		
		kW	71.2		
	(208-230)	Power input	18.67		
		Current input	57.5-52.0		
	(Rated)	BTU/h	232,000		
		kW	68.0		
(208-230)	Power input	16.91		17.32	
	Current input	52.1-47.1		53.4-48.3	
Temp. range of heating	Indoor	D.B.	59~81°F (15~27°C)		
	Outdoor	W.B.	-13~60°F (-25~15.5°C)		
Indoor unit connectable	Total capacity	50~150% of outdoor unit capacity			
	Model/Quantity	P04~P96/2~50			
Sound power level (measured in anechoic room)	*3	dB <A>	82.0/83.0		
Refrigerant piping diameter	High pressure	in. (mm)	7/8 (22.2) Brazed (1-1/8 (28.58) Brazed in pipe length over 65 m)		
	Low pressure	in. (mm)	1-3/8 (34.93) Brazed		

Set Model			PURY-EP120TNU-A (-BS)		PURY-EP96TNU-A (-BS)	
Model			PURY-EP120TNU-A (-BS)		PURY-EP96TNU-A (-BS)	
Minimum Circuit Ampacity	A		56-55		44-40	
Maximum Overcurrent Protection	A		90-90		70-60	
FAN	Type x Quantity		Propeller fan x 2		Propeller fan x 2	
	Airflow rate	cfm	8300		7400	
		m ³ /min	235		210	
		L/s	3920		3500	
	Control, Driving mechanism		Inverter-control, Brushless DC motor		Inverter-control, Brushless DC motor	
	Motor output	kW	0.46+0.46		0.46+0.46	
*4	External static press.		0 in.WG (0 Pa)		0 in.WG (0 Pa)	
Compressor	Type x Quantity		Inverter scroll hermetic compressor x 1		Inverter scroll hermetic compressor x 1	
	Starting method		Inverter		Inverter	
	Motor output	kW	7.6		5.5	
	Case heater	kW	-		-	
	Lubricant			MEL32		MEL32
External finish			Pre-coated galvanized steel sheet (+powder coating for -BS type) <MUNSELL 5Y 8/1>		Pre-coated galvanized steel sheet (+powder coating for -BS type) <MUNSELL 5Y 8/1>	
External dimension H x W x D			in. 71-5/8 x 48-7/8 x 29-3/16		in. 71-5/8 x 48-7/8 x 29-3/16	
			mm 1,818 x 1,240 x 740		mm 1,818 x 1,240 x 740	
Protection devices	High pressure protection		High pressure sensor, High pressure switch at 4.15 MPa (601 psi)		High pressure sensor, High pressure switch at 4.15 MPa (601 psi)	
	Inverter circuit (COMP./FAN)		Over-current protection		Over-current protection	
	Compressor		-		-	
	Fan motor		-		-	
Refrigerant	Type x original charge		R410A x 17 lbs + 10 oz (8.0 kg)		R410A x 17 lbs + 10 oz (8.0 kg)	
	Control		Indoor LEV and BC controller			
Net weight	lbs (kg)		622 (282)		613 (278)	
Heat exchanger			Salt-resistant cross fin & aluminium tube		Salt-resistant cross fin & aluminium tube	
HIC circuit (HIC: Heat Inter-Changer)			-			
Pipe between unit and distributor	High pressure	in. (mm)	3/4 (19.05) Brazed		3/4 (19.05) Brazed	
	Low pressure	in. (mm)	1-1/8 (28.58) Brazed		7/8 (22.2) Brazed	
Defrosting method			Auto-defrost mode (Reversed refrigerant cycle)			
Drawing	External		KL94R879			
	Wiring		KE94G655		KE94G655	
Standard attachment	Document		Installation Manual			
	Accessory		Details refer to External Drw			
Optional parts			Outdoor Twinning kit: CMY-R200NCBK joint: CMY-Y102SS-G2, CMY-Y102LS-G2, CMY-R160-J1 Main BC controller: CMB-P108, 1012, 1016NU-JA1, CMB-P1016NU-KA1 Sub BC controller: CMB-P104, 108NU-KB1			
Remarks			Details on foundation work, duct work, insulation work, electrical wiring, power source switch, and other items shall be referred to the Installation Manual.			

Notes:		Unit converter
1. Nominal cooling conditions (Test conditions are based on AHRI 1230) Indoor: 80°F D.B./67°F W.B. (26.7°C D.B./19.4°C W.B.), Outdoor: 95°F D.B. (35°C D.B.)		BTU/h = kW x 3.412
2. Nominal heating conditions (Test conditions are based on AHRI 1230) Indoor: 70°F D.B. (21.1°C D.B.), Outdoor: 47°F D.B./43°F W.B. (8.3°C D.B./6.1°C W.B.)		cfm = m ³ /min x 35.31
3. Cooling mode/Heating mode		lbs = kg/0.4536
4. External static pressure option is available (0.12 in.WG, 0.24 in.WG, 0.32 in.WG/30 Pa, 60 Pa, 80 Pa).		
Due to continuing improvement, above specifications may be subject to change without notice.		*Above specification data is subject to rounding variation.

1. SPECIFICATIONS

R2-Series (High efficiency)

PURY-EP-T(S)NU-A, Y(S)NU-A

Outdoor Model			PURY-EP240TSNU-A (-BS)		
Indoor Model			Non-Ducted		Ducted
Power source			3-phase 3-wire 208-230V±10% 60Hz		
Cooling capacity (Nominal)	*1	BTU/h	240,000		
		kW	70.3		
	(208-230)	Power input	19.17		
		Current input	59.1-53.4		
	(Rated)	BTU/h	230,000		
		kW	67.4		
(208-230)	Power input	22.35	22.60		
	Current input	68.9-62.3	69.7-63.0		
Temp. range of cooling	Indoor	W.B.	59~75°F (15~24°C)		
	Outdoor	D.B.	23~126°F (-5~52°C)		
Heating capacity (Nominal)	*2	BTU/h	270,000		
		kW	79.1		
	(208-230)	Power input	22.03		
		Current input	67.9-61.4		
	(Rated)	BTU/h	258,000		
		kW	75.6		
(208-230)	Power input	20.52	19.90		
	Current input	63.2-57.2	61.3-55.5		
Temp. range of heating	Indoor	D.B.	59~81°F (15~27°C)		
	Outdoor	W.B.	-13~60°F (-25~15.5°C)		
Indoor unit connectable	Total capacity	50~150% of outdoor unit capacity			
	Model/Quantity	P04~P96/2~50			
Sound power level (measured in anechoic room)	*3	dB <A>	83.0/83.5		
Refrigerant piping diameter	High pressure	in. (mm)	7/8 (22.2) Brazed (1-1/8 (28.58) Brazed in pipe length over 65 m)		
	Low pressure	in. (mm)	1-3/8 (34.93) Brazed		

Set Model			PURY-EP120TNU-A (-BS)		PURY-EP120TNU-A (-BS)	
Model			PURY-EP120TNU-A (-BS)		PURY-EP120TNU-A (-BS)	
Minimum Circuit Ampacity	A		56-55		56-55	
Maximum Overcurrent Protection	A		90-90		90-90	
FAN	Type x Quantity		Propeller fan x 2		Propeller fan x 2	
	Airflow rate	cfm	8300		8300	
		m ³ /min	235		235	
		L/s	3920		3920	
	Control, Driving mechanism		Inverter-control, Brushless DC motor		Inverter-control, Brushless DC motor	
	Motor output	kW	0.46+0.46		0.46+0.46	
External static press.	*4		0 in.WG (0 Pa)		0 in.WG (0 Pa)	
Compressor	Type x Quantity		Inverter scroll hermetic compressor x 1		Inverter scroll hermetic compressor x 1	
	Starting method		Inverter		Inverter	
	Motor output	kW	7.6		7.6	
	Case heater	kW	-		-	
	Lubricant			MEL32		MEL32
External finish			Pre-coated galvanized steel sheet (+powder coating for -BS type) <MUNSELL 5Y 8/1>		Pre-coated galvanized steel sheet (+powder coating for -BS type) <MUNSELL 5Y 8/1>	
External dimension H x W x D			in. 71-5/8 x 48-7/8 x 29-3/16		in. 71-5/8 x 48-7/8 x 29-3/16	
			mm 1,818 x 1,240 x 740		mm 1,818 x 1,240 x 740	
Protection devices	High pressure protection		High pressure sensor, High pressure switch at 4.15 MPa (601 psi)		High pressure sensor, High pressure switch at 4.15 MPa (601 psi)	
	Inverter circuit (COMP./FAN)		Over-current protection		Over-current protection	
	Compressor		-		-	
	Fan motor		-		-	
Refrigerant	Type x original charge		R410A x 17 lbs + 10 oz (8.0 kg)		R410A x 17 lbs + 10 oz (8.0 kg)	
	Control		Indoor LEV and BC controller			
Net weight	lbs (kg)	622 (282)		622 (282)		
Heat exchanger			Salt-resistant cross fin & aluminium tube		Salt-resistant cross fin & aluminium tube	
HIC circuit (HIC: Heat Inter-Changer)			-			
Pipe between unit and distributor	High pressure	in. (mm)	3/4 (19.05) Brazed		3/4 (19.05) Brazed	
	Low pressure	in. (mm)	1-1/8 (28.58) Brazed		1-1/8 (28.58) Brazed	
Defrosting method			Auto-defrost mode (Reversed refrigerant cycle)			
Drawing	External		KL94R879			
	Wiring		KE94G655		KE94G655	
Standard attachment	Document		Installation Manual			
	Accessory		Details refer to External Drw			
Optional parts			Outdoor Twinning kit: CMY-R200NCBK joint: CMY-Y102SS-G2, CMY-Y102LS-G2, CMY-R160-J1 Main BC controller: CMB-P108, 1012, 1016NU-JA1, CMB-P1016NU-KA1 Sub BC controller: CMB-P104, 108NU-KB1			
Remarks			Details on foundation work, duct work, insulation work, electrical wiring, power source switch, and other items shall be referred to the Installation Manual.			

Notes:	Unit converter
1. Nominal cooling conditions (Test conditions are based on AHRI 1230) Indoor: 80°F D.B./67°F W.B. (26.7°C D.B./19.4°C W.B.), Outdoor: 95°F D.B. (35°C D.B.)	BTU/h = kW x 3.412
2. Nominal heating conditions (Test conditions are based on AHRI 1230) Indoor: 70°F D.B. (21.1°C D.B.), Outdoor: 47°F D.B./43°F W.B. (8.3°C D.B./6.1°C W.B.)	cfm = m ³ /min x 35.31
3. Cooling mode/Heating mode	lbs = kg/0.4536
4. External static pressure option is available (0.12 in.WG, 0.24 in.WG, 0.32 in.WG/30 Pa, 60 Pa, 80 Pa).	
Due to continuing improvement, above specifications may be subject to change without notice.	*Above specification data is subject to rounding variation.

1. SPECIFICATIONS

R2-Series (High efficiency)

PURY-EP-T(S)NU-A, Y(S)NU-A

Outdoor Model			PURY-EP264TSNU-A (-BS)		
Indoor Model			Non-Ducted		Ducted
Power source			3-phase 3-wire 208-230V±10% 60Hz		
Cooling capacity (Nominal)	*1	BTU/h	264,000		
		kW	77.4		
	(208-230)	Power input	21.86		
		Current input	67.4-60.9		
	(Rated)	BTU/h	252,000		
		kW	73.9		
(208-230)	Power input	25.30	25.43		
	Current input	A	78.0-70.5		
Temp. range of cooling	Indoor	W.B.	59~75°F (15~24°C)		
	Outdoor	D.B.	23~126°F (-5~52°C)		
Heating capacity (Nominal)	*2	BTU/h	295,000		
		kW	86.5		
	(208-230)	Power input	24.56		
		Current input	75.7-68.5		
	(Rated)	BTU/h	280,000		
		kW	82.1		
(208-230)	Power input	22.65	22.30		
	Current input	A	69.8-63.1		
Temp. range of heating	Indoor	D.B.	59~81°F (15~27°C)		
	Outdoor	W.B.	-13~60°F (-25~15.5°C)		
Indoor unit connectable	Total capacity	50~150% of outdoor unit capacity			
	Model/Quantity	P04~P96/2~50			
Sound power level (measured in anechoic room)	*3	dB <A>	87.0/87.0		
Refrigerant piping diameter	High pressure	in. (mm)	1-1/8 (28.58) Brazed		
	Low pressure	in. (mm)	1-3/8 (34.93) Brazed		

Set Model			PURY-EP144TNU-A (-BS)		PURY-EP120TNU-A (-BS)	
Model			PURY-EP144TNU-A (-BS)		PURY-EP120TNU-A (-BS)	
Minimum Circuit Ampacity	A		60-60		56-55	
Maximum Overcurrent Protection	A		100-100		90-90	
FAN	Type x Quantity		Propeller fan x 2		Propeller fan x 2	
	Airflow rate	cfm	9,550		8,300	
		m ³ /min	270		235	
		L/s	4,500		3,920	
	Control, Driving mechanism		Inverter-control, Brushless DC motor		Inverter-control, Brushless DC motor	
	Motor output	kW	0.46+0.46		0.46+0.46	
*4	External static press.		0 in.WG (0 Pa)		0 in.WG (0 Pa)	
Compressor	Type x Quantity		Inverter scroll hermetic compressor x 1		Inverter scroll hermetic compressor x 1	
	Starting method		Inverter		Inverter	
	Motor output	kW	9.8		7.6	
	Case heater	kW	-		-	
	Lubricant			MEL32		MEL32
External finish			Pre-coated galvanized steel sheet (+powder coating for -BS type) <MUNSELL 5Y 8/1>		Pre-coated galvanized steel sheet (+powder coating for -BS type) <MUNSELL 5Y 8/1>	
External dimension H x W x D			in. 71-5/8 x 48-7/8 x 29-3/16 mm 1,818 x 1,240 x 740		in. 71-5/8 x 48-7/8 x 29-3/16 mm 1,818 x 1,240 x 740	
Protection devices	High pressure protection		High pressure sensor, High pressure switch at 4.15 MPa (601 psi)		High pressure sensor, High pressure switch at 4.15 MPa (601 psi)	
	Inverter circuit (COMP./FAN)		Over-current protection		Over-current protection	
	Compressor		-		-	
	Fan motor		-		-	
Refrigerant	Type x original charge		R410A x 23 lbs + 12 oz (10.8 kg)		R410A x 17 lbs + 10 oz (8.0 kg)	
	Control		Indoor LEV and BC controller			
Net weight	lbs (kg)		680 (308)		622 (282)	
Heat exchanger			Salt-resistant cross fin & aluminium tube		Salt-resistant cross fin & aluminium tube	
HIC circuit (HIC: Heat Inter-Changer)			-		-	
Pipe between unit and distributor	High pressure	in. (mm)	7/8 (22.2) Brazed		3/4 (19.05) Brazed	
	Low pressure	in. (mm)	1-1/8 (28.58) Brazed		1-1/8 (28.58) Brazed	
Defrosting method			Auto-defrost mode (Reversed refrigerant cycle)			
Drawing	External		KL94R879			
	Wiring		KE94G655		KE94G655	
Standard attachment	Document		Installation Manual			
	Accessory		Details refer to External Drw			
Optional parts			Outdoor Twinning kit: CMY-R300NCBK joint: CMY-Y102SS-G2, CMY-Y102LS-G2, CMY-R160-J1 Main BC controller: CMB-P108, 1012, 1016NU-JA1, CMB-P1016NU-KA1 Sub BC controller: CMB-P104, 108NU-KB1			
Remarks			Details on foundation work, duct work, insulation work, electrical wiring, power source switch, and other items shall be referred to the Installation Manual.			

Notes:		Unit converter
1. Nominal cooling conditions (Test conditions are based on AHRI 1230) Indoor: 80°F D.B./67°F W.B. (26.7°C D.B./19.4°C W.B.), Outdoor: 95°F D.B. (35°C D.B.)		BTU/h = kW x 3.412
2. Nominal heating conditions (Test conditions are based on AHRI 1230) Indoor: 70°F D.B. (21.1°C D.B.), Outdoor: 47°F D.B./43°F W.B. (8.3°C D.B./6.1°C W.B.)		cfm = m ³ /min x 35.31
3. Cooling mode/Heating mode		lbs = kg/0.4536
4. External static pressure option is available (0.12 in.WG, 0.24 in.WG, 0.32 in.WG/30 Pa, 60 Pa, 80 Pa).		
Due to continuing improvement, above specifications may be subject to change without notice.		*Above specification data is subject to rounding variation.

1. SPECIFICATIONS

R2-Series (High efficiency)

PURY-EP-T(S)NU-A, Y(S)NU-A

Outdoor Model			PURY-EP288TSNU-A (-BS)		
Indoor Model			Non-Ducted	Ducted	
Power source			3-phase 3-wire 208-230V±10% 60Hz		
Cooling capacity (Nominal)	*1	BTU/h	288,000		
		kW	84.4		
	(208-230)	Power input	24.83		
		Current input	76.5-69.2		
	(Rated)	BTU/h	276,000		
		kW	80.9		
(208-230)	Power input	28.60	28.45		
	Current input	88.2-79.7	87.7-79.3		
Temp. range of cooling	Indoor	W.B.	59~75°F (15~24°C)		
	Outdoor	D.B.	23~126°F (-5~52°C)		
Heating capacity (Nominal)	*2	BTU/h	323,000		
		kW	94.7		
	(208-230)	Power input	27.30		
		Current input	84.1-76.1		
	(Rated)	BTU/h	304,000		
		kW	89.1		
(208-230)	Power input	25.15	25.05		
	Current input	77.5-70.1	77.2-69.8		
Temp. range of heating	Indoor	D.B.	59~81°F (15~27°C)		
	Outdoor	W.B.	-13~60°F (-25~15.5°C)		
Indoor unit connectable	Total capacity	50~150% of outdoor unit capacity			
	Model/Quantity	P04~P96/2~50			
Sound power level (measured in anechoic room)	*3	dB <A>	88.5/88.5		
Refrigerant piping diameter	High pressure	in. (mm)	1-1/8 (28.58) Brazed		
	Low pressure	in. (mm)	1-3/8 (34.93) Brazed		

Set Model			PURY-EP144TNU-A (-BS)		PURY-EP144TNU-A (-BS)		
Model			PURY-EP144TNU-A (-BS)		PURY-EP144TNU-A (-BS)		
Minimum Circuit Ampacity			A	60-60	60-60		
Maximum Overcurrent Protection			A	100-100	100-100		
FAN	Type x Quantity		Propeller fan x 2			Propeller fan x 2	
	Airflow rate	cfm	9550			9550	
		m ³ /min	270			270	
		L/s	4500			4500	
	Control, Driving mechanism		Inverter-control, Brushless DC motor			Inverter-control, Brushless DC motor	
	Motor output	kW	0.46+0.46			0.46+0.46	
*4 External static press.		0 in.WG (0 Pa)			0 in.WG (0 Pa)		
Compressor	Type x Quantity		Inverter scroll hermetic compressor x 1			Inverter scroll hermetic compressor x 1	
	Starting method		Inverter			Inverter	
	Motor output	kW	9.8			9.8	
	Case heater	kW	-			-	
	Lubricant		MEL32			MEL32	
External finish			Pre-coated galvanized steel sheet (+powder coating for -BS type) <MUNSELL 5Y 8/1>		Pre-coated galvanized steel sheet (+powder coating for -BS type) <MUNSELL 5Y 8/1>		
External dimension H x W x D			in.	71-5/8 x 48-7/8 x 29-3/16	71-5/8 x 48-7/8 x 29-3/16		
			mm	1,818 x 1,240 x 740	1,818 x 1,240 x 740		
Protection devices	High pressure protection		High pressure sensor, High pressure switch at 4.15 MPa (601 psi)			High pressure sensor, High pressure switch at 4.15 MPa (601 psi)	
	Inverter circuit (COMP./FAN)		Over-current protection			Over-current protection	
	Compressor		-			-	
	Fan motor		-			-	
Refrigerant	Type x original charge		R410A x 23 lbs + 12 oz (10.8 kg)			R410A x 23 lbs + 12 oz (10.8 kg)	
	Control		Indoor LEV and BC controller				
Net weight			lbs (kg)	680 (308)	680 (308)		
Heat exchanger			Salt-resistant cross fin & aluminium tube			Salt-resistant cross fin & aluminium tube	
HIC circuit (HIC: Heat Inter-Changer)			-				
Pipe between unit and distributor	High pressure	in. (mm)	7/8 (22.2) Brazed			7/8 (22.2) Brazed	
	Low pressure	in. (mm)	1-1/8 (28.58) Brazed			1-1/8 (28.58) Brazed	
Defrosting method			Auto-defrost mode (Reversed refrigerant cycle)				
Drawing	External		KL94R879				
	Wiring		KE94G655		KE94G655		
Standard attachment	Document		Installation Manual				
	Accessory		Details refer to External Drw				
Optional parts			Outdoor Twinning kit: CMY-R300NCBK joint: CMY-Y102SS-G2, CMY-Y102LS-G2, CMY-R160-J1 Main BC controller: CMB-P108, 1012, 1016NU-JA1, CMB-P1016NU-KA1 Sub BC controller: CMB-P104, 108NU-KB1				
Remarks			Details on foundation work, duct work, insulation work, electrical wiring, power source switch, and other items shall be referred to the Installation Manual.				

Notes:	Unit converter
1. Nominal cooling conditions (Test conditions are based on AHRI 1230) Indoor: 80°F D.B./67°F W.B. (26.7°C D.B./19.4°C W.B.), Outdoor: 95°F D.B. (35°C D.B.)	BTU/h = kW x 3,412
2. Nominal heating conditions (Test conditions are based on AHRI 1230) Indoor: 70°F D.B. (21.1°C D.B.), Outdoor: 47°F D.B./43°F W.B. (8.3°C D.B./6.1°C W.B.)	cfm = m ³ /min x 35.31
3. Cooling mode/Heating mode	lbs = kg/0.4536
4. External static pressure option is available (0.12 in.WG, 0.24 in.WG, 0.32 in.WG/30 Pa, 60 Pa, 80 Pa).	
Due to continuing improvement, above specifications may be subject to change without notice.	*Above specification data is subject to rounding variation.

1. SPECIFICATIONS

R2-Series (High efficiency)

PURY-EP-T(S)NU-A, Y(S)NU-A

Outdoor Model			PURY-EP312TSNU-A (-BS)			
Indoor Model			Non-Ducted		Ducted	
Power source			3-phase 3-wire 208-230V±10% 60Hz			
Cooling capacity (Nominal)	*1	BTU/h	312,000			
		kW	91.4			
	(208-230)	Power input	kW	27.98		
		Current input	A	86.2-78.0		
	(Rated)	(208-230)	BTU/h	298,000		
			kW	87.3		
		Power input	kW	30.80	30.68	
		Current input	A	94.9-85.9	94.6-85.5	
Temp. range of cooling	Indoor	W.B.	59~75°F (15~24°C)			
	Outdoor	D.B.	23~126°F (-5~52°C)			
Heating capacity (Nominal)	*2	BTU/h	350,000			
		kW	102.6			
	(208-230)	Power input	kW	30.53		
		Current input	A	94.1-85.1		
	(Rated)	(208-230)	BTU/h	334,000		
			kW	97.9		
		Power input	kW	28.35	27.78	
		Current input	A	87.4-79.0	85.6-77.4	
Temp. range of heating	Indoor	D.B.	59~81°F (15~27°C)			
	Outdoor	W.B.	-13~60°F (-25~15.5°C)			
Indoor unit connectable	Total capacity	50~150% of outdoor unit capacity				
	Model/Quantity	P04~P96/2~50				
Sound power level (measured in anechoic room)	*3	dB <A>	87.0/88.5			
Refrigerant piping diameter	High pressure	in. (mm)	1-1/8 (28.58) Brazed			
	Low pressure	in. (mm)	1-5/8 (41.28) Brazed			

Set Model			PURY-EP168TNU-A (-BS)		PURY-EP144TNU-A (-BS)		
Model			PURY-EP168TNU-A (-BS)		PURY-EP144TNU-A (-BS)		
Minimum Circuit Ampacity	A		70-70		60-60		
Maximum Overcurrent Protection	A		110-110		100-100		
FAN	Type x Quantity		Propeller fan x 2		Propeller fan x 2		
	Airflow rate	cfm	14850		9550		
		m ³ /min	420		270		
		L/s	7000		4500		
	Control, Driving mechanism		Inverter-control, Brushless DC motor		Inverter-control, Brushless DC motor		
	Motor output	kW	0.92+0.92		0.46+0.46		
*4	External static press.		0 in.WG (0 Pa)		0 in.WG (0 Pa)		
Compressor	Type x Quantity		Inverter scroll hermetic compressor x 1		Inverter scroll hermetic compressor x 1		
	Starting method		Inverter		Inverter		
	Motor output	kW	12.2		9.8		
	Case heater	kW	-		-		
	Lubricant			MEL32		MEL32	
External finish			Pre-coated galvanized steel sheet (+powder coating for -BS type) <MUNSELL 5Y 8/1>		Pre-coated galvanized steel sheet (+powder coating for -BS type) <MUNSELL 5Y 8/1>		
External dimension H x W x D			in.	71-5/8 x 68-15/16 x 29-3/16		71-5/8 x 48-7/8 x 29-3/16	
			mm	1,818 x 1,750 x 740		1,818 x 1,240 x 740	
Protection devices	High pressure protection		High pressure sensor, High pressure switch at 4.15 MPa (601 psi)		High pressure sensor, High pressure switch at 4.15 MPa (601 psi)		
	Inverter circuit (COMP./FAN)		Over-current protection		Over-current protection		
	Compressor		-		-		
	Fan motor		-		-		
Refrigerant	Type x original charge		R410A x 23 lbs + 12 oz (10.8 kg)		R410A x 23 lbs + 12 oz (10.8 kg)		
	Control		Indoor LEV and BC controller				
Net weight	lbs (kg)		777 (352)		680 (308)		
Heat exchanger			Salt-resistant cross fin & aluminium tube		Salt-resistant cross fin & aluminium tube		
HIC circuit (HIC: Heat Inter-Changer)			-				
Pipe between unit and distributor	High pressure	in. (mm)	7/8 (22.2) Brazed		7/8 (22.2) Brazed		
	Low pressure	in. (mm)	1-1/8 (28.58) Brazed		1-1/8 (28.58) Brazed		
Defrosting method			Auto-defrost mode (Reversed refrigerant cycle)				
Drawing	External		KL94R880				
	Wiring		KE94G654		KE94G655		
Standard attachment	Document		Installation Manual				
	Accessory		Details refer to External Drw				
Optional parts			Outdoor Twinning kit: CMY-R300NCBK joint: CMY-Y102SS-G2, CMY-Y102LS-G2, CMY-R160-J1 Main BC controller: CMB-P108, 1012, 1016NU-JA1, CMB-P1016NU-KA1 Sub BC controller: CMB-P104, 108NU-KB1				
Remarks			Details on foundation work, duct work, insulation work, electrical wiring, power source switch, and other items shall be referred to the Installation Manual.				

Notes:	Unit converter
1. Nominal cooling conditions (Test conditions are based on AHRI 1230) Indoor: 80°F D.B./67°F W.B. (26.7°C D.B./19.4°C W.B.), Outdoor: 95°F D.B. (35°C D.B.)	BTU/h = kW x 3.412
2. Nominal heating conditions (Test conditions are based on AHRI 1230) Indoor: 70°F D.B. (21.1°C D.B.), Outdoor: 47°F D.B./43°F W.B. (8.3°C D.B./6.1°C W.B.)	cfm = m ³ /min x 35.31
3. Cooling mode/Heating mode	lbs = kg/0.4536
4. External static pressure option is available (0.12 in.WG, 0.24 in.WG, 0.32 in.WG/30 Pa, 60 Pa, 80 Pa).	
Due to continuing improvement, above specifications may be subject to change without notice.	*Above specification data is subject to rounding variation.

1. SPECIFICATIONS

R2-Series (High efficiency)

PURY-EP-T(S)NU-A, Y(S)NU-A

Outdoor Model		PURY-EP336TSNU-A (-BS)		
Indoor Model		Non-Ducted	Ducted	
Power source		3-phase 3-wire 208-230V±10% 60Hz		
Cooling capacity (Nominal)	*1	BTU/h	336,000	
		kW	98.5	
	(208-230)	Power input	kW	31.43
		Current input	A	96.9-87.6
	(Rated)		BTU/h	320,000
			kW	93.8
(208-230)	Power input	kW	33.45	
	Current input	A	103.1-93.2	
Temp. range of cooling	Indoor	W.B.	59~75°F (15~24°C)	
	Outdoor	D.B.	23~126°F (-5~52°C)	
Heating capacity (Nominal)	*2	BTU/h	378,000	
		kW	110.8	
	(208-230)	Power input	kW	33.55
		Current input	A	103.4-93.5
	(Rated)		BTU/h	360,000
			kW	105.5
(208-230)	Power input	kW	31.30	
	Current input	A	96.5-87.2	
Temp. range of heating	Indoor	D.B.	59~81°F (15~27°C)	
	Outdoor	W.B.	-13~60°F (-25~15.5°C)	
Indoor unit connectable	Total capacity	50~150% of outdoor unit capacity		
	Model/Quantity	P04~P96/2~50		
Sound power level (measured in anechoic room)	*3	dB <A>	84.5/88.5	
Refrigerant piping diameter	High pressure	in. (mm)	1-1/8 (28.58) Brazed	
	Low pressure	in. (mm)	1-5/8 (41.28) Brazed	

Set Model		PURY-EP168TNU-A (-BS)		PURY-EP168TNU-A (-BS)		
Model		PURY-EP168TNU-A (-BS)		PURY-EP168TNU-A (-BS)		
Minimum Circuit Ampacity	A	70-70		70-70		
Maximum Overcurrent Protection	A	110-110		110-110		
FAN	Type x Quantity		Propeller fan x 2		Propeller fan x 2	
	Airflow rate	cfm	14850		14850	
		m ³ /min	420		420	
		L/s	7000		7000	
	Control, Driving mechanism		Inverter-control, Brushless DC motor		Inverter-control, Brushless DC motor	
	Motor output	kW	0.92+0.92		0.92+0.92	
External static press.	*4	0 in.WG (0 Pa)		0 in.WG (0 Pa)		
Compressor	Type x Quantity		Inverter scroll hermetic compressor x 1		Inverter scroll hermetic compressor x 1	
	Starting method		Inverter		Inverter	
	Motor output	kW	12.2		12.2	
	Case heater	kW	-		-	
	Lubricant		MEL32		MEL32	
External finish		Pre-coated galvanized steel sheet (+powder coating for -BS type) <MUNSELL 5Y 8/1>		Pre-coated galvanized steel sheet (+powder coating for -BS type) <MUNSELL 5Y 8/1>		
External dimension H x W x D		in.	71-5/8 x 68-15/16 x 29-3/16		71-5/8 x 68-15/16 x 29-3/16	
		mm	1,818 x 1,750 x 740		1,818 x 1,750 x 740	
Protection devices	High pressure protection		High pressure sensor, High pressure switch at 4.15 MPa (601 psi)		High pressure sensor, High pressure switch at 4.15 MPa (601 psi)	
	Inverter circuit (COMP./FAN)		Over-current protection		Over-current protection	
	Compressor		-		-	
	Fan motor		-		-	
Refrigerant	Type x original charge		R410A x 23 lbs + 12 oz (10.8 kg)		R410A x 23 lbs + 12 oz (10.8 kg)	
	Control		Indoor LEV and BC controller			
Net weight	lbs (kg)	777 (352)		777 (352)		
Heat exchanger		Salt-resistant cross fin & aluminium tube				
HIC circuit (HIC: Heat Inter-Changer)		-				
Pipe between unit and distributor	High pressure	in. (mm)	7/8 (22.2) Brazed		7/8 (22.2) Brazed	
	Low pressure	in. (mm)	1-1/8 (28.58) Brazed		1-1/8 (28.58) Brazed	
Defrosting method		Auto-defrost mode (Reversed refrigerant cycle)				
Drawing	External	KL94R881				
	Wiring	KE94G654		KE94G654		
Standard attachment	Document	Installation Manual				
	Accessory	Details refer to External Drw				
Optional parts		Outdoor Twinning kit: CMY-R300NCBK joint: CMY-Y102SS-G2, CMY-Y102LS-G2, CMY-R160-J1 Main BC controller: CMB-P108, 1012, 1016NU-JA1, CMB-P1016NU-KA1 Sub BC controller: CMB-P104, 108NU-KB1				
Remarks		Details on foundation work, duct work, insulation work, electrical wiring, power source switch, and other items shall be referred to the Installation Manual.				

Notes:	Unit converter
1. Nominal cooling conditions (Test conditions are based on AHRI 1230) Indoor: 80°F D.B./67°F W.B. (26.7°C D.B./19.4°C W.B.), Outdoor: 95°F D.B. (35°C D.B.)	BTU/h = kW x 3,412
2. Nominal heating conditions (Test conditions are based on AHRI 1230) Indoor: 70°F D.B. (21.1°C D.B.), Outdoor: 47°F D.B./43°F W.B. (8.3°C D.B./6.1°C W.B.)	cfm = m ³ /min x 35.31
3. Cooling mode/Heating mode	lbs = kg/0.4536
4. External static pressure option is available (0.12 in.WG, 0.24 in.WG, 0.32 in.WG/30 Pa, 60 Pa, 80 Pa).	
Due to continuing improvement, above specifications may be subject to change without notice.	*Above specification data is subject to rounding variation.

1. SPECIFICATIONS

R2-Series (High efficiency)

PURY-EP-T(S)NU-A, Y(S)NU-A

Outdoor Model			PURY-EP384TSNU-A (-BS)		
Indoor Model			Non-Ducted		Ducted
Power source			3-phase 3-wire 208-230V±10% 60Hz		
Cooling capacity (Nominal)	*1	BTU/h	384,000		
		kW	112.5		
	(208-230)	Power input	36.62		
		Current input	112.9-102.1		
	(Rated)	BTU/h	364,000		
		kW	106.7		
(208-230)	Power input	39.05		38.27	
	Current input	120.4-108.9		118.0-106.7	
Temp. range of cooling	Indoor	W.B.	59~75°F (15~24°C)		
	Outdoor	D.B.	23~126°F (-5~52°C)		
Heating capacity (Nominal)	*2	BTU/h	430,000		
		kW	126.0		
	(208-230)	Power input	38.66		
		Current input	119.2-107.8		
	(Rated)	BTU/h	410,000		
		kW	120.2		
(208-230)	Power input	36.47		34.75	
	Current input	112.4-101.7		107.1-96.9	
Temp. range of heating	Indoor	D.B.	59~81°F (15~27°C)		
	Outdoor	W.B.	-13~60°F (-25~15.5°C)		
Indoor unit connectable	Total capacity	50~150% of outdoor unit capacity			
	Model/Quantity	P04~P96/2~50			
Sound power level (measured in anechoic room)	*3	dB <A>	86.5/89.0		
Refrigerant piping diameter	High pressure	in. (mm)	1-1/8 (28.58) Brazed		
	Low pressure	in. (mm)	1-5/8 (41.28) Brazed		

Set Model			PURY-EP192TNU-A (-BS)		PURY-EP192TNU-A (-BS)	
Model			PURY-EP192TNU-A (-BS)		PURY-EP192TNU-A (-BS)	
Minimum Circuit Ampacity	A		80-75		80-75	
Maximum Overcurrent Protection	A		125-125		125-125	
FAN	Type x Quantity		Propeller fan x 2		Propeller fan x 2	
	Airflow rate	cfm	13050		13050	
		m ³ /min	370		370	
		L/s	6170		6170	
	Control, Driving mechanism		Inverter-control, Brushless DC motor		Inverter-control, Brushless DC motor	
	Motor output	kW	0.92±0.92		0.92±0.92	
*4	External static press.		0 in.WG (0 Pa)		0 in.WG (0 Pa)	
Compressor	Type x Quantity		Inverter scroll hermetic compressor x 1		Inverter scroll hermetic compressor x 1	
	Starting method		Inverter		Inverter	
	Motor output	kW	13.2		13.2	
	Case heater	kW	-		-	
	Lubricant			MEL32		MEL32
External finish			Pre-coated galvanized steel sheet (+powder coating for -BS type) <MUNSELL 5Y 8/1>		Pre-coated galvanized steel sheet (+powder coating for -BS type) <MUNSELL 5Y 8/1>	
External dimension H x W x D			in. 71-5/8 x 68-15/16 x 29-3/16 mm 1,818 x 1,750 x 740		in. 71-5/8 x 68-15/16 x 29-3/16 mm 1,818 x 1,750 x 740	
Protection devices	High pressure protection		High pressure sensor, High pressure switch at 4.15 MPa (601 psi)		High pressure sensor, High pressure switch at 4.15 MPa (601 psi)	
	Inverter circuit (COMP./FAN)		Over-current protection		Over-current protection	
	Compressor		-		-	
	Fan motor		-		-	
Refrigerant	Type x original charge		R410A x 26 lbs + 1 oz (11.8 kg)		R410A x 26 lbs + 1 oz (11.8 kg)	
	Control		Indoor LEV and BC controller			
Net weight	lbs (kg)		887 (402)		887 (402)	
Heat exchanger			Salt-resistant cross fin & aluminium tube		Salt-resistant cross fin & aluminium tube	
HIC circuit (HIC: Heat Inter-Changer)			-			
Pipe between unit and distributor	High pressure	in. (mm)	7/8 (22.2) Brazed		7/8 (22.2) Brazed	
	Low pressure	in. (mm)	1-1/8 (28.58) Brazed		1-1/8 (28.58) Brazed	
Defrosting method			Auto-defrost mode (Reversed refrigerant cycle)			
Drawing	External		KB94C1J5			
	Wiring		KE94G984		KE94G984	
Standard attachment	Document		Installation Manual			
	Accessory		Details refer to External Drw			
Optional parts			Outdoor Twinning kit: CMY-R300NCBK joint: CMY-Y102SS-G2, CMY-Y102LS-G2, CMY-R160-J1 Main BC controller: CMB-P1016NU-KA1 Sub BC controller: CMB-P104, 108NU-KB1			
Remarks			Details on foundation work, duct work, insulation work, electrical wiring, power source switch, and other items shall be referred to the Installation Manual.			

Notes:		Unit converter
1. Nominal cooling conditions (Test conditions are based on AHRI 1230) Indoor: 80°F D.B./67°F W.B. (26.7°C D.B./19.4°C W.B.), Outdoor: 95°F D.B. (35°C D.B.)		BTU/h = kW x 3.412
2. Nominal heating conditions (Test conditions are based on AHRI 1230) Indoor: 70°F D.B. (21.1°C D.B.), Outdoor: 47°F D.B./43°F W.B. (8.3°C D.B./6.1°C W.B.)		cfm = m ³ /min x 35.31
3. Cooling mode/Heating mode		lbs = kg/0.4536
4. External static pressure option is available (0.12 in.WG, 0.24 in.WG, 0.32 in.WG/30 Pa, 60 Pa, 80 Pa).		
Due to continuing improvement, above specifications may be subject to change without notice.		*Above specification data is subject to rounding variation.

1. SPECIFICATIONS

R2-Series (High efficiency)

PURY-EP-T(S)NU-A, Y(S)NU-A

Outdoor Model			PURY-EP432TSNU-A (-BS)		
Indoor Model			Non-Ducted	Ducted	
Power source			3-phase 3-wire 208-230V±10% 60Hz		
Cooling capacity (Nominal)	*1	BTU/h	432,000		
		kW	126.6		
	(208-230)	Power input	42.36		
		Current input	130.6-118.1		
	(Rated)	BTU/h	410,000		
		kW	120.2		
(208-230)	Power input	44.40	43.98		
	Current input	136.9-123.8	135.6-122.6		
Temp. range of cooling	Indoor	W.B.	59~75°F (15~24°C)		
	Outdoor	D.B.	23~126°F (-5~52°C)		
Heating capacity (Nominal)	*2	BTU/h	480,000		
		kW	140.7		
	(208-230)	Power input	43.14		
		Current input	133.0-120.3		
	(Rated)	BTU/h	455,000		
		kW	133.4		
(208-230)	Power input	40.70	38.90		
	Current input	125.5-113.5	119.9-108.4		
Temp. range of heating	Indoor	D.B.	59~81°F (15~27°C)		
	Outdoor	W.B.	-13~60°F (-25~15.5°C)		
Indoor unit connectable	Total capacity	50~150% of outdoor unit capacity			
	Model/Quantity	P04~P96/2~50			
Sound power level (measured in anechoic room)	*3	dB <A>	89.0/89.0		
Refrigerant piping diameter	High pressure	in. (mm)	1-1/8 (28.58) Brazed		
	Low pressure	in. (mm)	1-5/8 (41.28) Brazed		

Set Model			PURY-EP216TNU-A (-BS)		PURY-EP216TNU-A (-BS)	
Model			PURY-EP216TNU-A (-BS)		PURY-EP216TNU-A (-BS)	
Minimum Circuit Ampacity	A		88-85		88-85	
Maximum Overcurrent Protection	A		150-150		150-150	
FAN	Type x Quantity		Propeller fan x 2		Propeller fan x 2	
	Airflow rate	cfm	14100		14100	
		m ³ /min	400		400	
		L/s	6670		6670	
	Control, Driving mechanism		Inverter-control, Brushless DC motor		Inverter-control, Brushless DC motor	
	Motor output	kW	0.92+0.92		0.92+0.92	
*4	External static press.		0 in.WG (0 Pa)		0 in.WG (0 Pa)	
Compressor	Type x Quantity		Inverter scroll hermetic compressor x 1		Inverter scroll hermetic compressor x 1	
	Starting method		Inverter		Inverter	
	Motor output	kW	15.8		15.8	
	Case heater	kW	-		-	
	Lubricant			MEL32		MEL32
External finish			Pre-coated galvanized steel sheet (+powder coating for -BS type) <MUNSELL 5Y 8/1>		Pre-coated galvanized steel sheet (+powder coating for -BS type) <MUNSELL 5Y 8/1>	
External dimension H x W x D			in. 71-5/8 x 68-15/16 x 29-3/16		in. 71-5/8 x 68-15/16 x 29-3/16	
			mm 1,818 x 1,750 x 740		mm 1,818 x 1,750 x 740	
Protection devices	High pressure protection		High pressure sensor, High pressure switch at 4.15 MPa (601 psi)		High pressure sensor, High pressure switch at 4.15 MPa (601 psi)	
	Inverter circuit (COMP./FAN)		Over-current protection		Over-current protection	
	Compressor		-		-	
	Fan motor		-		-	
Refrigerant	Type x original charge		R410A x 26 lbs + 1 oz (11.8 kg)		R410A x 26 lbs + 1 oz (11.8 kg)	
	Control		Indoor LEV and BC controller			
Net weight	lbs (kg)		887 (402)		887 (402)	
Heat exchanger			Salt-resistant cross fin & aluminium tube		Salt-resistant cross fin & aluminium tube	
HIC circuit (HIC: Heat Inter-Changer)			-			
Pipe between unit and distributor	High pressure	in. (mm)	7/8 (22.2) Brazed		7/8 (22.2) Brazed	
	Low pressure	in. (mm)	1-1/8 (28.58) Brazed		1-1/8 (28.58) Brazed	
Defrosting method			Auto-defrost mode (Reversed refrigerant cycle)			
Drawing	External		KB94C1J5			
	Wiring		KE94G984		KE94G984	
Standard attachment	Document		Installation Manual			
	Accessory		Details refer to External Drw			
Optional parts			Outdoor Twinning kit: CMY-R300NCBK joint: CMY-Y102SS-G2, CMY-Y102LS-G2, CMY-R160-J1 Main BC controller: CMB-P1016NU-KA1 Sub BC controller: CMB-P104, 108NU-KB1			
Remarks			Details on foundation work, duct work, insulation work, electrical wiring, power source switch, and other items shall be referred to the Installation Manual.			

Notes:	Unit converter
1.Nominal cooling conditions (Test conditions are based on AHRI 1230) Indoor: 80°F D.B./67°F W.B. (26.7°C D.B./19.4°C W.B.), Outdoor: 95°F D.B. (35°C D.B.)	BTU/h =kW x 3,412
2.Nominal heating conditions (Test conditions are based on AHRI 1230) Indoor: 70°F D.B. (21.1°C D.B.), Outdoor: 47°F D.B./43°F W.B. (8.3°C D.B./6.1°C W.B.)	cfm =m ³ /min x 35.31
3.Cooling mode/Heating mode	lbs =kg/0.4536
4.External static pressure option is available (0.12 in.WG, 0.24 in.WG, 0.32 in.WG/30 Pa, 60 Pa, 80 Pa).	
Due to continuing improvement, above specifications may be subject to change without notice.	*Above specification data is subject to rounding variation.

1. SPECIFICATIONS

R2-Series (High efficiency)

Outdoor Model		PURY-EP72YNU-A (-BS)		
Indoor Model		Non-Ducted	Ducted	
Power source		3-phase 3-wire 460V±10% 60Hz		
Cooling capacity (Nominal)	*1	BTU/h	72,000	
		kW	21.1	
	(460)	Power input	kW	
		Current input	A	
	(Rated)	BTU/h	69,000	
			kW	20.2
(460)	Power input	5.40	5.45	
	Current input	7.5	7.6	
Temp. range of cooling	Indoor	W.B.	59~75°F (15~24°C)	
	Outdoor	D.B.	23~126°F (-5~52°C)	
Heating capacity (Nominal)	*2	BTU/h	80,000	
		kW	23.4	
	(460)	Power input	kW	
		Current input	A	
	(Rated)	BTU/h	76,000	
			kW	22.3
(460)	Power input	4.77	5.28	
	Current input	6.6	7.3	
Temp. range of heating	Indoor	D.B.	59~81°F (15~27°C)	
	Outdoor	W.B.	-13~60°F (-25~15.5°C)	
Indoor unit connectable	Total capacity	50~150% of outdoor unit capacity		
	Model/Quantity	P04~P96/1~18		
Sound power level (measured in anechoic room)	*3	dB <A>	75.5/77.0	
Refrigerant piping diameter	High pressure	in. (mm)	5/8 (15.88) Brazed	
	Low pressure	in. (mm)	3/4 (19.05) Brazed	
Minimum Circuit Ampacity	A		14	
Maximum Overcurrent Protection	A		20	
FAN	Type x Quantity		Propeller fan x 1	
	Airflow rate	cfm	6,000	
		m ³ /min	170	
		L/s	2,830	
	Control, Driving mechanism		Inverter-control, Brushless DC motor	
	Motor output	kW		0.92
*4	External static press.		0 in.WG (0 Pa)	
Compressor	Type x Quantity		Inverter scroll hermetic compressor x 1	
	Starting method		Inverter	
	Motor output	kW		3.8
	Case heater	kW		-
	Lubricant		MEL32	
External finish		Pre-coated galvanized steel sheet (+powder coating for -BS type) <MUNSELL 5Y 8/1>		
External dimension H x W x D	in.	71-5/8 x 36-1/4 x 29-3/16		
	mm	1,818 x 920 x 740		
Protection devices	High pressure protection		High pressure sensor, High pressure switch at 4.15 MPa (601 psi)	
	Inverter circuit (COMP./FAN)		Over-current protection	
	Compressor		-	
	Fan motor		-	
Refrigerant	Type x original charge		R410A x 11 lbs + 7 oz (5.2 kg)	
	Control		Indoor LEV and BC controller	
Net weight	lbs (kg)		552 (250)	
Heat exchanger		Salt-resistant cross fin & aluminium tube		
HIC circuit (HIC: Heat Inter-Changer)		-		
Defrosting method		Auto-defrost mode (Reversed refrigerant cycle)		
Drawing	External	KL94R882		
	Wiring	KE94G653		
Standard attachment	Document	Installation Manual		
	Accessory	Details refer to External Drw		
Optional parts		joint: CMY-Y102SS-G2,CMY-Y102LS-G2,CMY-R160-J1 BC controller: CMB-P104,106,108,1012,1016NU-J1 Main BC controller: CMB-P108,1012,1016NU-JA1,CMB-P1016NU-KA1 Sub BC controller: CMB-P104,108NU-KB1		
Remarks		Details on foundation work, duct work, insulation work, electrical wiring, power source switch, and other items shall be referred to the Installation Manual.		

Notes:	Unit converter
1.Nominal cooling conditions (Test conditions are based on AHRI 1230) Indoor: 80°F D.B./67°F W.B. (26.7°C D.B./19.4°C W.B.), Outdoor: 95°F D.B. (35°C D.B.)	BTU/h =kW x 3,412
2.Nominal heating conditions (Test conditions are based on AHRI 1230) Indoor: 70°F D.B. (21.1°C D.B.), Outdoor: 47°F D.B./43°F W.B. (8.3°C D.B./6.1°C W.B.)	cfm =m ³ /min x 35.31
3.Cooling mode/Heating mode	lbs =kg/0.4536
4.External static pressure option is available (0.12 in.WG, 0.24 in.WG, 0.32 in.WG/30 Pa, 60 Pa, 80 Pa).	
Due to continuing improvement, above specifications may be subject to change without notice.	*Above specification data is subject to rounding variation.

1. SPECIFICATIONS

R2-Series (High efficiency)

PURY-EP-T(S)NU-A, Y(S)NU-A

Outdoor Model		PURY-EP96YNU-A (-BS)		
Indoor Model		Non-Ducted	Ducted	
Power source		3-phase 3-wire 460V±10% 60Hz		
Cooling capacity (Nominal)	*1	BTU/h	96,000	
		kW	28.1	
	(460)	Power input	kW	6.11
		Current input	A	8.5
	(Rated)	*1	BTU/h	92,000
			kW	27.0
(460)	Power input	kW	7.36	
	Current input	A	10.2	
Temp. range of cooling	Indoor	W.B.	59~75°F (15~24°C)	
	Outdoor	D.B.	23~126°F (-5~52°C)	
Heating capacity (Nominal)	*2	BTU/h	108,000	
		kW	31.7	
	(460)	Power input	kW	7.40
		Current input	A	10.3
	(Rated)	*2	BTU/h	103,000
			kW	30.2
(460)	Power input	kW	6.72	
	Current input	A	9.3	
Temp. range of heating	Indoor	D.B.	59~81°F (15~27°C)	
	Outdoor	W.B.	-13~60°F (-25~15.5°C)	
Indoor unit connectable	Total capacity	50~150% of outdoor unit capacity		
	Model/Quantity	P04~P96/1~24		
Sound power level (measured in anechoic room) *3		dB <A>	77.5/79.0	
Refrigerant piping diameter	High pressure	in. (mm)	3/4 (19.05) Brazed	
	Low pressure	in. (mm)	7/8 (22.2) Brazed	
Minimum Circuit Ampacity		A	20	
Maximum Overcurrent Protection		A	30	
FAN	Type x Quantity		Propeller fan x 2	
	Airflow rate	cfm	7,400	
		m ³ /min	210	
		L/s	3,500	
	Control, Driving mechanism		Inverter-control, Brushless DC motor	
	Motor output	kW	0.46+0.46	
*4	External static press.		0 in.WG (0 Pa)	
Compressor	Type x Quantity		Inverter scroll hermetic compressor x 1	
	Starting method		Inverter	
	Motor output	kW	5.5	
	Case heater	kW	-	
	Lubricant		MEL32	
External finish		Pre-coated galvanized steel sheet (+powder coating for -BS type) <MUNSELL 5Y 8/1>		
External dimension H x W x D		in.	71-5/8 x 48-7/8 x 29-3/16	
		mm	1,818 x 1,240 x 740	
Protection devices	High pressure protection		High pressure sensor, High pressure switch at 4.15 MPa (601 psi)	
	Inverter circuit (COMP./FAN)		Over-current protection	
	Compressor		-	
	Fan motor		-	
Refrigerant	Type x original charge		R410A x 17 lbs + 10 oz (8.0 kg)	
	Control		Indoor LEV and BC controller	
Net weight	lbs (kg)	649 (294)		
Heat exchanger		Salt-resistant cross fin & aluminium tube		
HIC circuit (HIC: Heat Inter-Changer)		-		
Defrosting method		Auto-defrost mode (Reversed refrigerant cycle)		
Drawing	External	KL94R883		
	Wiring	KE94G652		
Standard attachment	Document	Installation Manual		
	Accessory	Details refer to External Drw		
Optional parts		joint: CMY-Y102SS-G2, CMY-Y102LS-G2, CMY-R160-J1 BC controller: CMB-P104, 106, 108, 1012, 1016NU-J1 Main BC controller: CMB-P108, 1012, 1016NU-JA1, CMB-P1016NU-KA1 Sub BC controller: CMB-P104, 108NU-KB1		
Remarks		Details on foundation work, duct work, insulation work, electrical wiring, power source switch, and other items shall be referred to the Installation Manual.		

Notes:	Unit converter
1. Nominal cooling conditions (Test conditions are based on AHRI 1230) Indoor: 80°F D.B./67°F W.B. (26.7°C D.B./19.4°C W.B.), Outdoor: 95°F D.B. (35°C D.B.)	BTU/h = kW x 3,412
2. Nominal heating conditions (Test conditions are based on AHRI 1230) Indoor: 70°F D.B. (21.1°C D.B.), Outdoor: 47°F D.B./43°F W.B. (8.3°C D.B./6.1°C W.B.)	cfm = m ³ /min x 35.31
3. Cooling mode/Heating mode	lbs = kg/0.4536
4. External static pressure option is available (0.12 in.WG, 0.24 in.WG, 0.32 in.WG/30 Pa, 60 Pa, 80 Pa).	
Due to continuing improvement, above specifications may be subject to change without notice.	*Above specification data is subject to rounding variation.

1. SPECIFICATIONS

R2-Series (High efficiency)

Outdoor Model		PURY-EP120YNU-A (-BS)		
Indoor Model		Non-Ducted	Ducted	
Power source		3-phase 3-wire 460V±10% 60Hz		
Cooling capacity (Nominal)	*1	BTU/h	120,000	
		kW	35.2	
	(460)	Power input	8.43	
		Current input	11.7	
	(Rated)	BTU/h	115,000	
		kW	33.7	
	(460)	Power input	10.55	10.45
		Current input	14.7	14.5
Temp. range of cooling	Indoor	W.B.	59~75°F (15~24°C)	
	Outdoor	D.B.	23~126°F (-5~52°C)	
Heating capacity (Nominal)	*2	BTU/h	135,000	
		kW	39.6	
	(460)	Power input	9.89	
		Current input	13.7	
	(Rated)	BTU/h	129,000	
		kW	37.8	
	(460)	Power input	8.95	9.22
		Current input	12.4	12.8
Temp. range of heating	Indoor	D.B.	59~81°F (15~27°C)	
	Outdoor	W.B.	-13~60°F (-25~15.5°C)	
Indoor unit connectable	Total capacity	50~150% of outdoor unit capacity		
	Model/Quantity	P04~P96/1~30		
Sound power level (measured in anechoic room)	*3	dB <A>	80.5/80.5	
Refrigerant piping diameter	High pressure	in. (mm)	3/4 (19.05) Brazed	
	Low pressure	in. (mm)	1-1/8 (28.58) Brazed	
Minimum Circuit Ampacity			A	
Maximum Overcurrent Protection			A	
FAN	Type x Quantity		Propeller fan x 2	
	Airflow rate	cfm	8,300	
		m ³ /min	235	
		L/s	3,920	
	Control, Driving mechanism		Inverter-control, Brushless DC motor	
	Motor output	kW	0.46+0.46	
*4	External static press.		0 in.WG (0 Pa)	
Compressor	Type x Quantity		Inverter scroll hermetic compressor x 1	
	Starting method		Inverter	
	Motor output	kW	7.6	
	Case heater	kW	-	
	Lubricant		MEL32	
External finish		Pre-coated galvanized steel sheet (+powder coating for -BS type) <MUNSELL 5Y 8/1>		
External dimension H x W x D	in.	71-5/8 x 48-7/8 x 29-3/16		
	mm	1,818 x 1,240 x 740		
Protection devices	High pressure protection		High pressure sensor, High pressure switch at 4.15 MPa (601 psi)	
	Inverter circuit (COMP./FAN)		Over-current protection	
	Compressor		-	
	Fan motor		-	
Refrigerant	Type x original charge		R410A x 17 lbs + 10 oz (8.0 kg)	
	Control		Indoor LEV and BC controller	
Net weight	lbs (kg)	657 (298)		
Heat exchanger		Salt-resistant cross fin & aluminium tube		
HIC circuit (HIC: Heat Inter-Changer)		-		
Defrosting method		Auto-defrost mode (Reversed refrigerant cycle)		
Drawing	External	KL94R883		
	Wiring	KE94G652		
Standard attachment	Document	Installation Manual		
	Accessory	Details refer to External Drw		
Optional parts		joint: CMY-Y102SS-G2, CMY-Y102LS-G2, CMY-R160-J1 BC controller: CMB-P104,106,108,1012,1016NU-J1 Main BC controller: CMB-P108,1012,1016NU-JA1, CMB-P1016NU-KA1 Sub BC controller: CMB-P104,108NU-KB1		
Remarks		Details on foundation work, duct work, insulation work, electrical wiring, power source switch, and other items shall be referred to the Installation Manual.		

Notes:	Unit converter
1. Nominal cooling conditions (Test conditions are based on AHRI 1230) Indoor: 80°F D.B./67°F W.B. (26.7°C D.B./19.4°C W.B.), Outdoor: 95°F D.B. (35°C D.B.)	BTU/h = kW x 3,412
2. Nominal heating conditions (Test conditions are based on AHRI 1230) Indoor: 70°F D.B. (21.1°C D.B.), Outdoor: 47°F D.B./43°F W.B. (8.3°C D.B./6.1°C W.B.)	cfm = m ³ /min x 35.31
3. Cooling mode/Heating mode	lbs = kg/0.4536
4. External static pressure option is available (0.12 in.WG, 0.24 in.WG, 0.32 in.WG/30 Pa, 60 Pa, 80 Pa).	
Due to continuing improvement, above specifications may be subject to change without notice.	*Above specification data is subject to rounding variation.

1. SPECIFICATIONS

R2-Series (High efficiency)

PURY-EP-T(S)NU-A, Y(S)NU-A

Outdoor Model		PURY-EP144YNU-A (-BS)		
Indoor Model		Non-Ducted	Ducted	
Power source		3-phase 3-wire 460V±10% 60Hz		
Cooling capacity (Nominal)	*1	BTU/h	144,000	
		kW	42.2	
	(460)	Power input	11.03	
		Current input	15.3	
	(Rated)	BTU/h	138,000	
		kW	40.4	
(460)	Power input	13.30	13.10	
	Current input	18.5	18.2	
Temp. range of cooling	Indoor	W.B.	59~75°F (15~24°C)	
	Outdoor	D.B.	23~126°F (-5~52°C)	
Heating capacity (Nominal)	*2	BTU/h	160,000	
		kW	46.9	
	(460)	Power input	12.34	
		Current input	17.2	
	(Rated)	BTU/h	152,000	
		kW	44.5	
(460)	Power input	11.08	11.60	
	Current input	15.4	16.1	
Temp. range of heating	Indoor	D.B.	59~81°F (15~27°C)	
	Outdoor	W.B.	-13~60°F (-25~15.5°C)	
Indoor unit connectable	Total capacity	50~150% of outdoor unit capacity		
	Model/Quantity	P04~P96/1~36		
Sound power level (measured in anechoic room) *3		dB <A>	85.5/85.5	
Refrigerant piping diameter	High pressure	in. (mm)	7/8 (22.2) Brazed	
	Low pressure	in. (mm)	1-1/8 (28.58) Brazed	
Minimum Circuit Ampacity		A	34	
Maximum Overcurrent Protection		A	50	
FAN	Type x Quantity		Propeller fan x 2	
	Airflow rate	cfm	9,550	
		m ³ /min	270	
		L/s	4,500	
	Control, Driving mechanism		Inverter-control, Brushless DC motor	
	Motor output	kW	0.46+0.46	
*4	External static press.		0 in.WG (0 Pa)	
Compressor	Type x Quantity		Inverter scroll hermetic compressor x 1	
	Starting method		Inverter	
	Motor output	kW	9.8	
	Case heater	kW	-	
	Lubricant		MEL32	
External finish		Pre-coated galvanized steel sheet (+powder coating for -BS type) <MUNSELL 5Y 8/1>		
External dimension H x W x D		in.	71-5/8 x 48-7/8 x 29-3/16	
		mm	1,818 x 1,240 x 740	
Protection devices	High pressure protection		High pressure sensor, High pressure switch at 4.15 MPa (601 psi)	
	Inverter circuit (COMP./FAN)		Over-current protection	
	Compressor		-	
	Fan motor		-	
Refrigerant	Type x original charge		R410A x 23 lbs + 12 oz (10.8 kg)	
	Control		Indoor LEV and BC controller	
Net weight	lbs (kg)	715 (324)		
Heat exchanger		Salt-resistant cross fin & aluminium tube		
HIC circuit (HIC: Heat Inter-Changer)		-		
Defrosting method		Auto-defrost mode (Reversed refrigerant cycle)		
Drawing	External	KL94R883		
	Wiring	KE94G652		
Standard attachment	Document	Installation Manual		
	Accessory	Details refer to External Drw		
Optional parts		joint: CMY-Y102SS-G2,CMY-Y102LS-G2,CMY-R160-J1 Main BC controller: CMB-P108,1012,1016NU-JA1,CMB-P1016NU-KA1 Sub BC controller: CMB-P104,108NU-KB1		
Remarks		Details on foundation work, duct work, insulation work, electrical wiring, power source switch, and other items shall be referred to the Installation Manual.		

Notes:	Unit converter
1.Nominal cooling conditions (Test conditions are based on AHRI 1230) Indoor: 80°F D.B./67°F W.B. (26.7°C D.B./19.4°C W.B.), Outdoor: 95°F D.B. (35°C D.B.)	BTU/h =kW x 3,412
2.Nominal heating conditions (Test conditions are based on AHRI 1230) Indoor: 70°F D.B. (21.1°C D.B.), Outdoor: 47°F D.B./43°F W.B. (8.3°C D.B./6.1°C W.B.)	cfm =m ³ /min x 35.31
3.Cooling mode/Heating mode	lbs =kg/0.4536
4.External static pressure option is available (0.12 in.WG, 0.24 in.WG, 0.32 in.WG/30 Pa, 60 Pa, 80 Pa).	
Due to continuing improvement, above specifications may be subject to change without notice.	*Above specification data is subject to rounding variation.

1. SPECIFICATIONS

R2-Series (High efficiency)

PURY-EP-T(S)NU-A, Y(S)NU-A

Outdoor Model		PURY-EP168YNU-A (-BS)		
Indoor Model		Non-Ducted	Ducted	
Power source		3-phase 3-wire 460V±10% 60Hz		
Cooling capacity (Nominal)	*1	BTU/h	168,000	
		kW	49.2	
	(460)	Power input	13.99	
		Current input	19.5	
	(Rated)	BTU/h	160,000	
		kW	46.9	
	(460)	Power input	15.40	15.30
		Current input	21.4	21.3
Temp. range of cooling	Indoor	W.B.	59~75°F (15~24°C)	
	Outdoor	D.B.	23~126°F (-5~52°C)	
Heating capacity (Nominal)	*2	BTU/h	188,000	
		kW	55.1	
	(460)	Power input	15.17	
		Current input	21.1	
	(Rated)	BTU/h	178,000	
		kW	52.2	
	(460)	Power input	13.23	14.42
		Current input	18.4	20.1
Temp. range of heating	Indoor	D.B.	59~81°F (15~27°C)	
	Outdoor	W.B.	-13~60°F (-25~15.5°C)	
Indoor unit connectable	Total capacity	50~150% of outdoor unit capacity		
	Model/Quantity	P04~P96/1~42		
Sound power level (measured in anechoic room)	*3	dB <A>	81.5/85.5	
Refrigerant piping diameter	High pressure	in. (mm)	7/8 (22.2) Brazed	
	Low pressure	in. (mm)	1-1/8 (28.58) Brazed	
Minimum Circuit Ampacity		A	35	
Maximum Overcurrent Protection		A	50	
FAN	Type x Quantity	Propeller fan x 2		
	Airflow rate	cfm	14,850	
		m ³ /min	420	
		L/s	7,000	
	Control, Driving mechanism	Inverter-control, Brushless DC motor		
	Motor output	kW	0.92+0.92	
*4 External static press.	0 in.WG (0 Pa)			
Compressor	Type x Quantity	Inverter scroll hermetic compressor x 1		
	Starting method	Inverter		
	Motor output	kW	12.2	
	Case heater	kW	-	
	Lubricant	MEL32		
External finish	Pre-coated galvanized steel sheet (+powder coating for -BS type) <MUNSELL 5Y 8/1>			
External dimension H x W x D	in.	71-5/8 x 68-15/16 x 29-3/16		
	mm	1,818 x 1,750 x 740		
Protection devices	High pressure protection	High pressure sensor, High pressure switch at 4.15 MPa (601 psi)		
	Inverter circuit (COMP./FAN)	Over-current protection		
	Compressor	-		
	Fan motor	-		
Refrigerant	Type x original charge	R410A x 23 lbs + 12 oz (10.8 kg)		
	Control	Indoor LEV and BC controller		
Net weight	lbs (kg)	807 (366)		
Heat exchanger	Salt-resistant cross fin & aluminium tube			
HIC circuit (HIC: Heat Inter-Changer)	-			
Defrosting method	Auto-defrost mode (Reversed refrigerant cycle)			
Drawing	External	KL94R884		
	Wiring	KE94G651		
Standard attachment	Document	Installation Manual		
	Accessory	Details refer to External Drw		
Optional parts	joint: CMY-Y102SS-G2, CMY-Y102LS-G2, CMY-R160-J1 Main BC controller: CMB-P108,1012,1016NU-JA1, CMB-P1016NU-KA1 Sub BC controller: CMB-P104,108NU-KB1			
Remarks	Details on foundation work, duct work, insulation work, electrical wiring, power source switch, and other items shall be referred to the Installation Manual.			

Notes:	Unit converter
1. Nominal cooling conditions (Test conditions are based on AHRI 1230) Indoor: 80°F D.B./67°F W.B. (26.7°C D.B./19.4°C W.B.), Outdoor: 95°F D.B. (35°C D.B.)	BTU/h = kW x 3,412
2. Nominal heating conditions (Test conditions are based on AHRI 1230) Indoor: 70°F D.B. (21.1°C D.B.), Outdoor: 47°F D.B./43°F W.B. (8.3°C D.B./6.1°C W.B.)	cfm = m ³ /min x 35.31
3. Cooling mode/Heating mode	lbs = kg/0.4536
4. External static pressure option is available (0.12 in.WG, 0.24 in.WG, 0.32 in.WG/30 Pa, 60 Pa, 80 Pa).	
Due to continuing improvement, above specifications may be subject to change without notice.	*Above specification data is subject to rounding variation.

1. SPECIFICATIONS

R2-Series (High efficiency)

PURY-EP-T(S)NU-A, Y(S)NU-A

Outdoor Model		PURY-EP192YNU-A (-BS)		
Indoor Model		Non-Ducted	Ducted	
Power source		3-phase 3-wire 460V±10% 60Hz		
Cooling capacity (Nominal)	*1	BTU/h	192,000	
		kW	56.3	
	(460)	Power input	15.65	
		Current input	21.8	
	(Rated)	BTU/h	184,000	
		kW	53.9	
	(460)	Power input	17.55	17.25
		Current input	24.4	24.0
Temp. range of cooling	Indoor	W.B.	59~75°F (15~24°C)	
	Outdoor	D.B.	23~126°F (-5~52°C)	
Heating capacity (Nominal)	*2	BTU/h	215,000	
		kW	63.0	
	(460)	Power input	17.54	
		Current input	24.4	
	(Rated)	BTU/h	204,000	
		kW	59.8	
	(460)	Power input	15.37	16.34
		Current input	21.4	22.7
Temp. range of heating	Indoor	D.B.	59~81°F (15~27°C)	
	Outdoor	W.B.	-13~60°F (-25~15.5°C)	
Indoor unit connectable	Total capacity	50~150% of outdoor unit capacity		
	Model/Quantity	P04~P96/1~48		
Sound power level (measured in anechoic room) *3		dB <A>	83.5/85.0	
Refrigerant piping diameter	High pressure	in. (mm)	7/8 (22.2) Brazed	
	Low pressure	in. (mm)	1-1/8 (28.58) Brazed	
Minimum Circuit Ampacity		A	38	
Maximum Overcurrent Protection		A	60	
FAN	Type x Quantity		Propeller fan x 2	
	Airflow rate	cfm	13,050	
		m ³ /min	370	
		L/s	6,170	
	Control, Driving mechanism		Inverter-control, Brushless DC motor	
	Motor output	kW	0.92±0.92	
*4	External static press.		0 in.WG (0 Pa)	
Compressor	Type x Quantity		Inverter scroll hermetic compressor x 1	
	Starting method		Inverter	
	Motor output	kW	13.2	
	Case heater	kW	-	
	Lubricant		MEL32	
External finish		Pre-coated galvanized steel sheet (+powder coating for -BS type) <MUNSELL 5Y 8/1>		
External dimension H x W x D	in.	71-5/8 x 68-15/16 x 29-3/16		
	mm	1,818 x 1,750 x 740		
Protection devices	High pressure protection		High pressure sensor, High pressure switch at 4.15 MPa (601 psi)	
	Inverter circuit (COMP./FAN)		Over-current protection	
	Compressor		-	
	Fan motor		-	
Refrigerant	Type x original charge		R410A x 26 lbs + 1 oz (11.8 kg)	
	Control		Indoor LEV and BC controller	
Net weight	lbs (kg)	918 (416)		
Heat exchanger		Salt-resistant cross fin & aluminium tube		
HIC circuit (HIC: Heat Inter-Changer)		-		
Defrosting method		Auto-defrost mode (Reversed refrigerant cycle)		
Drawing	External	KB94C1J6		
	Wiring	KE94G983		
Standard attachment	Document	Installation Manual		
	Accessory	Details refer to External Drw		
Optional parts		joint: CMY-Y102SS-G2,CMY-Y102LS-G2,CMY-R160-J1 Main BC controller: CMB-P108,1012,1016NU-JA1,CMB-P1016NU-KA1 Sub BC controller: CMB-P104,108NU-KB1		
Remarks		Details on foundation work, duct work, insulation work, electrical wiring, power source switch, and other items shall be referred to the Installation Manual.		

Notes:	Unit converter
1. Nominal cooling conditions (Test conditions are based on AHRI 1230) Indoor: 80°F D.B./67°F W.B. (26.7°C D.B./19.4°C W.B.), Outdoor: 95°F D.B. (35°C D.B.)	BTU/h =kW x 3,412
2. Nominal heating conditions (Test conditions are based on AHRI 1230) Indoor: 70°F D.B. (21.1°C D.B.), Outdoor: 47°F D.B./43°F W.B. (8.3°C D.B./6.1°C W.B.)	cfm =m ³ /min x 35.31
3. Cooling mode/Heating mode	lbs =kg/0.4536
4. External static pressure option is available (0.12 in.WG, 0.24 in.WG, 0.32 in.WG/30 Pa, 60 Pa, 80 Pa).	
Due to continuing improvement, above specifications may be subject to change without notice.	*Above specification data is subject to rounding variation.

1. SPECIFICATIONS

R2-Series (High efficiency)

PURY-EP-T(S)NU-A, Y(S)NU-A

Outdoor Model		PURY-EP216YNU-A (-BS)		
Indoor Model		Non-Ducted	Ducted	
Power source		3-phase 3-wire 460V±10% 60Hz		
Cooling capacity (Nominal)	*1	BTU/h	216,000	
		kW	63.3	
	(460)	Power input	18.66	
		Current input	26.0	
	(Rated)	BTU/h	206,000	
		kW	60.4	
	(460)	Power input	20.50	20.35
		Current input	28.5	28.3
Temp. range of cooling	Indoor	W.B.	59~75°F (15~24°C)	
	Outdoor	D.B.	23~126°F (-5~52°C)	
Heating capacity (Nominal)	*2	BTU/h	243,000	
		kW	71.2	
	(460)	Power input	20.43	
		Current input	28.4	
	(Rated)	BTU/h	232,000	
		kW	68.0	
	(460)	Power input	18.22	19.25
		Current input	25.4	26.8
Temp. range of heating	Indoor	D.B.	59~81°F (15~27°C)	
	Outdoor	W.B.	-13~60°F (-25~15.5°C)	
Indoor unit connectable	Total capacity	50~150% of outdoor unit capacity		
	Model/Quantity	P04~P96/2~50		
Sound power level (measured in anechoic room)	*3	dB <A> 86.0/86.5		
Refrigerant piping diameter	High pressure	in. (mm)	7/8 (22.2) Braze (1-1/8 (28.58) Braze for the part that exceeds 65 m)	
	Low pressure	in. (mm)	1-3/8 (34.93) Braze	
Minimum Circuit Ampacity	A		41	
Maximum Overcurrent Protection	A		70	
FAN	Type x Quantity	Propeller fan x 2		
	Airflow rate	cfm	14,100	
		m ³ /min	400	
		L/s	6,670	
	Control, Driving mechanism	Inverter-control, Brushless DC motor		
	Motor output	kW	0.92+0.92	
*4 External static press.	0 in.WG (0 Pa)			
Compressor	Type x Quantity	Inverter scroll hermetic compressor x 1		
	Starting method	Inverter		
	Motor output	kW	15.8	
	Case heater	kW	-	
	Lubricant	MEL32		
External finish	Pre-coated galvanized steel sheet (+powder coating for -BS type) <MUNSELL 5Y 8/1>			
External dimension H x W x D	in.	71-5/8 x 68-15/16 x 29-3/16		
	mm	1,818 x 1,750 x 740		
Protection devices	High pressure protection	High pressure sensor, High pressure switch at 4.15 MPa (601 psi)		
	Inverter circuit (COMP./FAN)	Over-current protection		
	Compressor	-		
	Fan motor	-		
Refrigerant	Type x original charge	R410A x 26 lbs + 1 oz (11.8 kg)		
	Control	Indoor LEV and BC controller		
Net weight	lbs (kg)	918 (416)		
Heat exchanger	Salt-resistant cross fin & aluminium tube			
HIC circuit (HIC: Heat Inter-Changer)	-			
Defrosting method	Auto-defrost mode (Reversed refrigerant cycle)			
Drawing	External	KB94C1J6		
	Wiring	KE94G983		
Standard attachment	Document	Installation Manual		
	Accessory	Details refer to External Drw		
Optional parts	joint: CMY-Y102SS-G2, CMY-Y102LS-G2, CMY-R160-J1 Main BC controller: CMB-P108, 1012, 1016NU-JA1, CMB-P1016NU-KA1 Sub BC controller: CMB-P104, 108NU-KB1			
Remarks	Details on foundation work, duct work, insulation work, electrical wiring, power source switch, and other items shall be referred to the Installation Manual.			

Notes:	Unit converter
1. Nominal cooling conditions (Test conditions are based on AHRI 1230) Indoor: 80°F D.B./67°F W.B. (26.7°C D.B./19.4°C W.B.), Outdoor: 95°F D.B. (35°C D.B.)	BTU/h = kW x 3,412
2. Nominal heating conditions (Test conditions are based on AHRI 1230) Indoor: 70°F D.B. (21.1°C D.B.), Outdoor: 47°F D.B./43°F W.B. (8.3°C D.B./6.1°C W.B.)	cfm = m ³ /min x 35.31
3. Cooling mode/Heating mode	lbs = kg/0.4536
4. External static pressure option is available (0.12 in.WG, 0.24 in.WG, 0.32 in.WG/30 Pa, 60 Pa, 80 Pa).	
Due to continuing improvement, above specifications may be subject to change without notice.	*Above specification data is subject to rounding variation.

1. SPECIFICATIONS

R2-Series (High efficiency)

PURY-EP-T(S)NU-A, Y(S)NU-A

Outdoor Model		PURY-EP240YNU-A (-BS)		
Indoor Model		Non-Ducted	Ducted	
Power source		3-phase 3-wire 460V±10% 60Hz		
Cooling capacity (Nominal)	*1	BTU/h	224,000	
		kW	65.7	
	(460)	Power input	21.39	
		Current input	29.8	
	(Rated)	BTU/h	214,000	
		kW	62.7	
(460)	Power input	21.60	21.00	
	Current input	30.1	29.2	
Temp. range of cooling	Indoor	W.B.	59~75°F (15~24°C)	
	Outdoor	D.B.	23~126°F (-5~52°C)	
Heating capacity (Nominal)	*2	BTU/h	250,000	
		kW	73.3	
	(460)	Power input	21.79	
		Current input	30.3	
	(Rated)	BTU/h	240,000	
		kW	70.3	
(460)	Power input	19.96	20.20	
	Current input	27.8	28.1	
Temp. range of heating	Indoor	D.B.	59~81°F (15~27°C)	
	Outdoor	W.B.	-13~60°F (-25~15.5°C)	
Indoor unit connectable	Total capacity	50~150% of outdoor unit capacity		
	Model/Quantity	P04~P96/2~50		
Sound power level (measured in anechoic room) *3		dB <A>	88.0/87.0	
Refrigerant piping diameter	High pressure	in. (mm)	7/8 (22.2) Brazed (1-1/8 (28.58) Brazed for the part that exceeds 65 m)	
	Low pressure	in. (mm)	1-3/8 (34.93) Brazed	
Minimum Circuit Ampacity		A	41	
Maximum Overcurrent Protection		A	70	
FAN	Type x Quantity		Propeller fan x 2	
	Airflow rate	cfm	14,500	
		m ³ /min	410	
		L/s	6,830	
	Control, Driving mechanism		Inverter-control, Brushless DC motor	
	Motor output	kW	0.92±0.92	
*4	External static press.		0 in.WG (0 Pa)	
Compressor	Type x Quantity		Inverter scroll hermetic compressor x 1	
	Starting method		Inverter	
	Motor output	kW	17.0	
	Case heater	kW	-	
	Lubricant		MEL32	
External finish		Pre-coated galvanized steel sheet (+powder coating for -BS type) <MUNSELL 5Y 8/1>		
External dimension H x W x D		in.	71-5/8 x 68-15/16 x 29-3/16	
		mm	1,818 x 1,750 x 740	
Protection devices	High pressure protection		High pressure sensor, High pressure switch at 4.15 MPa (601 psi)	
	Inverter circuit (COMP./FAN)		Over-current protection	
	Compressor		-	
	Fan motor		-	
Refrigerant	Type x original charge		R410A x 26 lbs + 1 oz (11.8 kg)	
	Control		Indoor LEV and BC controller	
Net weight		lbs (kg)	918 (416)	
Heat exchanger		Salt-resistant cross fin & aluminium tube		
HIC circuit (HIC: Heat Inter-Changer)		-		
Defrosting method		Auto-defrost mode (Reversed refrigerant cycle)		
Drawing	External		KB94C1J6	
	Wiring		KE94G983	
Standard attachment	Document		Installation Manual	
	Accessory		Details refer to External Drw	
Optional parts		joint: CMY-Y102SS-G2,CMY-Y102LS-G2,CMY-R160-J1 Main BC controller: CMB-P108,1012,1016NU-JA1,CMB-P1016NU-KA1 Sub BC controller: CMB-P104,108NU-KB1		
Remarks		Details on foundation work, duct work, insulation work, electrical wiring, power source switch, and other items shall be referred to the Installation Manual.		

Notes:	Unit converter
1. Nominal cooling conditions (Test conditions are based on AHRI 1230) Indoor: 80°F D.B./67°F W.B. (26.7°C D.B./19.4°C W.B.), Outdoor: 95°F D.B. (35°C D.B.)	BTU/h =kW x 3,412
2. Nominal heating conditions (Test conditions are based on AHRI 1230) Indoor: 70°F D.B. (21.1°C D.B.), Outdoor: 47°F D.B./43°F W.B. (8.3°C D.B./6.1°C W.B.)	cfm =m ³ /min x 35.31
3. Cooling mode/Heating mode	lbs =kg/0.4536
4. External static pressure option is available (0.12 in.WG, 0.24 in.WG, 0.32 in.WG/30 Pa, 60 Pa, 80 Pa).	
Due to continuing improvement, above specifications may be subject to change without notice.	*Above specification data is subject to rounding variation.

1. SPECIFICATIONS

R2-Series (High efficiency)

PURY-EP-T(S)NU-A, Y(S)NU-A

Outdoor Model			PURY-EP192YSNU-A (-BS)			
Indoor Model			Non-Ducted		Ducted	
Power source			3-phase 3-wire 460V±10% 60Hz			
Cooling capacity (Nominal)	*1	BTU/h	192,000			
		kW	56.3			
		Power input kW	13.60			
	(460)	(Rated)	Current input A	18.9		
			BTU/h	184,000		
			kW	53.9		
(460)	(Rated)	Power input kW	15.80	15.90		
		Current input A	22.0	22.1		
		Temp. range of cooling	Indoor W.B.	59~75°F (15~24°C)		
		Outdoor D.B.	23~126°F (-5~52°C)			
Heating capacity (Nominal)	*2	BTU/h	215,000			
		kW	63.0			
		Power input kW	16.02			
	(460)	(Rated)	Current input A	22.3		
			BTU/h	204,000		
			kW	59.8		
(460)	(Rated)	Power input kW	14.46	14.75		
		Current input A	20.1	20.5		
		Temp. range of heating	Indoor D.B.	59~81°F (15~27°C)		
		Outdoor W.B.	-13~60°F (-25~15.5°C)			
Indoor unit connectable	Total capacity		50~150% of outdoor unit capacity			
	Model/Quantity		P04~P96/1~48			
Sound power level (measured in anechoic room) *3			dB <A> 80.5/82.0			
Refrigerant piping diameter	High pressure		7/8 (22.2) Brazed			
	Low pressure		1-1/8 (28.58) Brazed			

Set Model			PURY-EP96YNU-A (-BS)		PURY-EP96YNU-A (-BS)	
Model			PURY-EP96YNU-A (-BS)		PURY-EP96YNU-A (-BS)	
Minimum Circuit Ampacity			A 20		20	
Maximum Overcurrent Protection			A 30		30	
FAN	Type x Quantity		Propeller fan x 2		Propeller fan x 2	
	Airflow rate	cfm	7400		7400	
		m ³ /min	210		210	
		L/s	3500		3500	
	Control, Driving mechanism		Inverter-control, Brushless DC motor		Inverter-control, Brushless DC motor	
	*4	Motor output		kW 0.46+0.46		0.46+0.46
External static press.		0 in.WG (0 Pa)		0 in.WG (0 Pa)		
Type x Quantity		Inverter scroll hermetic compressor x 1		Inverter scroll hermetic compressor x 1		
Starting method		Inverter		Inverter		
Compressor	Motor output		kW 5.5		5.5	
	Case heater		kW -		-	
	Lubricant		MEL32		MEL32	
	External finish		Pre-coated galvanized steel sheet (+powder coating for -BS type) <MUNSELL 5Y 8/1>		Pre-coated galvanized steel sheet (+powder coating for -BS type) <MUNSELL 5Y 8/1>	
External dimension H x W x D			in. 71-5/8 x 48-7/8 x 29-3/16		71-5/8 x 48-7/8 x 29-3/16	
			mm 1,818 x 1,240 x 740		1,818 x 1,240 x 740	
Protection devices	High pressure protection		High pressure sensor, High pressure switch at 4.15 MPa (601 psi)		High pressure sensor, High pressure switch at 4.15 MPa (601 psi)	
	Inverter circuit (COMP./FAN)		Over-current protection		Over-current protection	
	Compressor		-		-	
	Fan motor		-		-	
Refrigerant	Type x original charge		R410A x 17 lbs + 10 oz (8.0 kg)		R410A x 17 lbs + 10 oz (8.0 kg)	
	Control		Indoor LEV and BC controller			
Net weight			lbs (kg) 649 (294)		649 (294)	
Heat exchanger			Salt-resistant cross fin & aluminium tube		Salt-resistant cross fin & aluminium tube	
HIC circuit (HIC: Heat Inter-Changer)			-			
Pipe between unit and distributor	High pressure		in. (mm) 3/4 (19.05) Brazed		3/4 (19.05) Brazed	
	Low pressure		in. (mm) 7/8 (22.2) Brazed		7/8 (22.2) Brazed	
Defrosting method			Auto-defrost mode (Reversed refrigerant cycle)			
Drawing	External		KL94R885			
	Wiring		KE94G652		KE94G652	
Standard attachment	Document		Installation Manual			
	Accessory		Details refer to External Drw			
Optional parts			Outdoor Twinning kit: CMY-R200NCBK joint: CMY-Y102SS-G2, CMY-Y102LS-G2, CMY-R160-J1 Main BC controller: CMB-P108, 1012, 1016NU-JA1, CMB-P1016NU-KA1 Sub BC controller: CMB-P104, 108NU-KB1			
Remarks			Details on foundation work, duct work, insulation work, electrical wiring, power source switch, and other items shall be referred to the Installation Manual.			

Notes:	Unit converter
1. Nominal cooling conditions (Test conditions are based on AHRI 1230) Indoor: 80°F D.B./67°F W.B. (26.7°C D.B./19.4°C W.B.), Outdoor: 95°F D.B. (35°C D.B.)	BTU/h = kW x 3,412
2. Nominal heating conditions (Test conditions are based on AHRI 1230) Indoor: 70°F D.B. (21.1°C D.B.), Outdoor: 47°F D.B./43°F W.B. (8.3°C D.B./6.1°C W.B.)	cfm = m ³ /min x 35.31
3. Cooling mode/Heating mode	lbs = kg/0.4536
4. External static pressure option is available (0.12 in.WG, 0.24 in.WG, 0.32 in.WG/30 Pa, 60 Pa, 80 Pa).	
Due to continuing improvement, above specifications may be subject to change without notice.	*Above specification data is subject to rounding variation.

1. SPECIFICATIONS

R2-Series (High efficiency)

PURY-EP-T(S)NU-A, Y(S)NU-A

Outdoor Model		PURY-EP216YSNU-A (-BS)		
Indoor Model		Non-Ducted	Ducted	
Power source		3-phase 3-wire 460V±10% 60Hz		
Cooling capacity (Nominal)	*1	BTU/h	216,000	
		kW	63.3	
	Power input	kW	16.06	
	(460) Current input	A	22.3	
	(Rated)		BTU/h	206,000
			kW	60.4
(460)	Power input	kW	19.00	
	Current input	A	26.4	
Temp. range of cooling	Indoor	W.B.	59~75°F (15~24°C)	
	Outdoor	D.B.	23~126°F (-5~52°C)	
Heating capacity (Nominal)	*2	BTU/h	243,000	
		kW	71.2	
	Power input	kW	18.67	
	(460) Current input	A	26.0	
	(Rated)		BTU/h	232,000
			kW	68.0
(460)	Power input	kW	16.91	
	Current input	A	23.5	
Temp. range of heating	Indoor	D.B.	59~81°F (15~27°C)	
	Outdoor	W.B.	-13~60°F (-25~15.5°C)	
Indoor unit connectable	Total capacity	50~150% of outdoor unit capacity		
	Model/Quantity	P04~P96/2~50		
Sound power level (measured in anechoic room)	*3	dB <A>	82.0/83.0	
Refrigerant piping diameter	High pressure	in. (mm)	7/8 (22.2) Brazed (1-1/8 (28.58) Brazed for the part that exceeds 65 m)	
	Low pressure	in. (mm)	1-3/8 (34.93) Brazed	

Set Model		PURY-EP120YNU-A (-BS)		PURY-EP96YNU-A (-BS)		
Model		PURY-EP120YNU-A (-BS)		PURY-EP96YNU-A (-BS)		
Minimum Circuit Ampacity	A	26		20		
Maximum Overcurrent Protection	A	40		30		
FAN	Type x Quantity		Propeller fan x 2		Propeller fan x 2	
	Airflow rate	cfm	8300		7400	
		m ³ /min	235		210	
		L/s	3920		3500	
	Control, Driving mechanism		Inverter-control, Brushless DC motor		Inverter-control, Brushless DC motor	
	Motor output	kW	0.46+0.46		0.46+0.46	
*4 External static press.		0 in.WG (0 Pa)		0 in.WG (0 Pa)		
Compressor	Type x Quantity		Inverter scroll hermetic compressor x 1		Inverter scroll hermetic compressor x 1	
	Starting method		Inverter		Inverter	
	Motor output	kW	7.6		5.5	
	Case heater	kW	-		-	
	Lubricant		MEL32		MEL32	
External finish		Pre-coated galvanized steel sheet (+powder coating for -BS type) <MUNSELL 5Y 8/1>		Pre-coated galvanized steel sheet (+powder coating for -BS type) <MUNSELL 5Y 8/1>		
External dimension H x W x D		in.	71-5/8 x 48-7/8 x 29-3/16		71-5/8 x 48-7/8 x 29-3/16	
		mm	1,818 x 1,240 x 740		1,818 x 1,240 x 740	
Protection devices	High pressure protection		High pressure sensor, High pressure switch at 4.15 MPa (601 psi)		High pressure sensor, High pressure switch at 4.15 MPa (601 psi)	
	Inverter circuit (COMP./FAN)		Over-current protection		Over-current protection	
	Compressor		-		-	
	Fan motor		-		-	
Refrigerant	Type x original charge		R410A x 17 lbs + 10 oz (8.0 kg)		R410A x 17 lbs + 10 oz (8.0 kg)	
	Control		Indoor LEV and BC controller			
Net weight	lbs (kg)	657 (298)		649 (294)		
Heat exchanger		Salt-resistant cross fin & aluminium tube		Salt-resistant cross fin & aluminium tube		
HIC circuit (HIC: Heat Inter-Changer)		-				
Pipe between unit and distributor	High pressure	in. (mm)	3/4 (19.05) Brazed		3/4 (19.05) Brazed	
	Low pressure	in. (mm)	1-1/8 (28.58) Brazed		7/8 (22.2) Brazed	
Defrosting method		Auto-defrost mode (Reversed refrigerant cycle)				
Drawing	External	KL94R885				
	Wiring	KE94G652		KE94G652		
Standard attachment	Document	Installation Manual				
	Accessory	Details refer to External Drw				
Optional parts		Outdoor Twinning kit: CMY-R200NCBK joint: CMY-Y102SS-G2, CMY-Y102LS-G2, CMY-R160-J1 Main BC controller: CMB-P108, 1012, 1016NU-JA1, CMB-P1016NU-KA1 Sub BC controller: CMB-P104, 108NU-KB1				
Remarks		Details on foundation work, duct work, insulation work, electrical wiring, power source switch, and other items shall be referred to the Installation Manual.				

Notes:	Unit converter
1. Nominal cooling conditions (Test conditions are based on AHRI 1230) Indoor: 80°F D.B./67°F W.B. (26.7°C D.B./19.4°C W.B.), Outdoor: 95°F D.B. (35°C D.B.)	BTU/h = kW x 3.412
2. Nominal heating conditions (Test conditions are based on AHRI 1230) Indoor: 70°F D.B. (21.1°C D.B.), Outdoor: 47°F D.B./43°F W.B. (8.3°C D.B./6.1°C W.B.)	cfm = m ³ /min x 35.31
3. Cooling mode/Heating mode	lbs = kg/0.4536
4. External static pressure option is available (0.12 in.WG, 0.24 in.WG, 0.32 in.WG/30 Pa, 60 Pa, 80 Pa).	
Due to continuing improvement, above specifications may be subject to change without notice.	*Above specification data is subject to rounding variation.

1. SPECIFICATIONS

R2-Series (High efficiency)

PURY-EP-T(S)NU-A, Y(S)NU-A

Outdoor Model			PURY-EP240YSNU-A (-BS)			
Indoor Model			Non-Ducted		Ducted	
Power source			3-phase 3-wire 460V±10% 60Hz			
Cooling capacity (Nominal)	*1	BTU/h	240,000			
		kW	70.3			
	(460)	Power input	19.17			
		Current input	26.7			
	(Rated)	(460)	BTU/h	230,000		
			kW	67.4		
(460)	Power input	22.35	22.60			
	Current input	A	31.5			
Temp. range of cooling	Indoor	W.B.	59~75°F (15~24°C)			
	Outdoor	D.B.	23~126°F (-5~52°C)			
Heating capacity (Nominal)	*2	BTU/h	270,000			
		kW	79.1			
	(460)	Power input	22.03			
		Current input	30.7			
	(Rated)	(460)	BTU/h	258,000		
			kW	75.6		
(460)	Power input	20.52	19.90			
	Current input	A	27.7			
Temp. range of heating	Indoor	D.B.	59~81°F (15~27°C)			
	Outdoor	W.B.	-13~60°F (-25~15.5°C)			
Indoor unit connectable	Total capacity	50~150% of outdoor unit capacity				
	Model/Quantity	P04~P96/2~50				
Sound power level (measured in anechoic room)	*3	dB <A>	83.0/83.5			
Refrigerant piping diameter	High pressure	in. (mm)	7/8 (22.2) Brazed (1-1/8 (28.58) Brazed in pipe length over 65 m)			
	Low pressure	in. (mm)	1-3/8 (34.93) Brazed			

Set Model			PURY-EP120YNU-A (-BS)		PURY-EP120YNU-A (-BS)	
Model			PURY-EP120YNU-A (-BS)		PURY-EP120YNU-A (-BS)	
Minimum Circuit Ampacity	A		26		26	
Maximum Overcurrent Protection	A		40		40	
FAN	Type x Quantity		Propeller fan x 2		Propeller fan x 2	
	Airflow rate	cfm	8300		8300	
		m ³ /min	235		235	
		L/s	3920		3920	
	Control, Driving mechanism		Inverter-control, Brushless DC motor		Inverter-control, Brushless DC motor	
	Motor output	kW	0.46+0.46		0.46+0.46	
*4	External static press.		0 in.WG (0 Pa)		0 in.WG (0 Pa)	
Compressor	Type x Quantity		Inverter scroll hermetic compressor x 1		Inverter scroll hermetic compressor x 1	
	Starting method		Inverter		Inverter	
	Motor output	kW	7.6		7.6	
	Case heater	kW	-		-	
	Lubricant			MEL32		MEL32
External finish			Pre-coated galvanized steel sheet (+powder coating for -BS type) <MUNSELL 5Y 8/1>		Pre-coated galvanized steel sheet (+powder coating for -BS type) <MUNSELL 5Y 8/1>	
External dimension H x W x D			in. 71-5/8 x 48-7/8 x 29-3/16 mm 1,818 x 1,240 x 740		in. 71-5/8 x 48-7/8 x 29-3/16 mm 1,818 x 1,240 x 740	
Protection devices	High pressure protection		High pressure sensor, High pressure switch at 4.15 MPa (601 psi)		High pressure sensor, High pressure switch at 4.15 MPa (601 psi)	
	Inverter circuit (COMP./FAN)		Over-current protection		Over-current protection	
	Compressor		-		-	
	Fan motor		-		-	
Refrigerant	Type x original charge		R410A x 17 lbs + 10 oz (8.0 kg)		R410A x 17 lbs + 10 oz (8.0 kg)	
	Control		Indoor LEV and BC controller			
Net weight	lbs (kg)		657 (298)		657 (298)	
Heat exchanger			Salt-resistant cross fin & aluminium tube		Salt-resistant cross fin & aluminium tube	
HIC circuit (HIC: Heat Inter-Changer)			-			
Pipe between unit and distributor	High pressure		3/4 (19.05) Brazed		3/4 (19.05) Brazed	
	Low pressure		1-1/8 (28.58) Brazed		1-1/8 (28.58) Brazed	
Defrosting method			Auto-defrost mode (Reversed refrigerant cycle)			
Drawing	External		KL94R885			
	Wiring		KE94G652		KE94G652	
Standard attachment	Document		Installation Manual			
	Accessory		Details refer to External Drw			
Optional parts			Outdoor Twinning kit: CMY-R200NCBK joint: CMY-Y102SS-G2, CMY-Y102LS-G2, CMY-R160-J1 Main BC controller: CMB-P108, 1012, 1016NU-JA1, CMB-P1016NU-KA1 Sub BC controller: CMB-P104, 108NU-KB1			
Remarks			Details on foundation work, duct work, insulation work, electrical wiring, power source switch, and other items shall be referred to the Installation Manual.			

Notes:	Unit converter
1. Nominal cooling conditions (Test conditions are based on AHRI 1230) Indoor: 80°F D.B./67°F W.B. (26.7°C D.B./19.4°C W.B.), Outdoor: 95°F D.B. (35°C D.B.)	BTU/h = kW x 3.412
2. Nominal heating conditions (Test conditions are based on AHRI 1230) Indoor: 70°F D.B. (21.1°C D.B.), Outdoor: 47°F D.B./43°F W.B. (8.3°C D.B./6.1°C W.B.)	cfm = m ³ /min x 35.31
3. Cooling mode/Heating mode	lbs = kg/0.4536
4. External static pressure option is available (0.12 in.WG, 0.24 in.WG, 0.32 in.WG/30 Pa, 60 Pa, 80 Pa).	
Due to continuing improvement, above specifications may be subject to change without notice.	*Above specification data is subject to rounding variation.

1. SPECIFICATIONS

R2-Series (High efficiency)

PURY-EP-T(S)NU-A, Y(S)NU-A

Outdoor Model		PURY-EP264YSNU-A (-BS)		
Indoor Model		Non-Ducted	Ducted	
Power source		3-phase 3-wire 460V±10% 60Hz		
Cooling capacity (Nominal)	*1	BTU/h	264,000	
		kW	77.4	
	(460)	Power input	kW	21.86
		Current input	A	30.4
	(Rated)		BTU/h	252,000
			kW	73.9
(460)	Power input	kW	25.30	
	Current input	A	35.2	
Temp. range of cooling	Indoor	W.B.	59~75°F (15~24°C)	
	Outdoor	D.B.	23~126°F (-5~52°C)	
Heating capacity (Nominal)	*2	BTU/h	295,000	
		kW	86.5	
	(460)	Power input	kW	24.56
		Current input	A	34.2
	(Rated)		BTU/h	280,000
			kW	82.1
(460)	Power input	kW	22.65	
	Current input	A	31.5	
Temp. range of heating	Indoor	D.B.	59~81°F (15~27°C)	
	Outdoor	W.B.	-13~60°F (-25~15.5°C)	
Indoor unit connectable	Total capacity	50~150% of outdoor unit capacity		
	Model/Quantity	P04~P96/2~50		
Sound power level (measured in anechoic room)	*3	dB <A>	87.0/87.0	
Refrigerant piping diameter	High pressure	in. (mm)	1-1/8 (28.58) Brazed	
	Low pressure	in. (mm)	1-3/8 (34.93) Brazed	

Set Model		PURY-EP144YNU-A (-BS)	PURY-EP120YNU-A (-BS)	
Model		PURY-EP144YNU-A (-BS)	PURY-EP120YNU-A (-BS)	
Minimum Circuit Ampacity	A	34	26	
Maximum Overcurrent Protection	A	50	40	
FAN	Type x Quantity	Propeller fan x 2		
	Airflow rate	cfm	9550	8300
		m ³ /min	270	235
		L/s	4500	3920
	Control, Driving mechanism	Inverter-control, Brushless DC motor		
	Motor output	kW	0.46+0.46	0.46+0.46
*4 External static press.		0 in.WG (0 Pa)	0 in.WG (0 Pa)	
Compressor	Type x Quantity	Inverter scroll hermetic compressor x 1		
	Starting method	Inverter		
	Motor output	kW	9.8	7.6
	Case heater	kW	-	-
	Lubricant	MEL32		
External finish		Pre-coated galvanized steel sheet (+powder coating for -BS type) <MUNSELL 5Y 8/1>	Pre-coated galvanized steel sheet (+powder coating for -BS type) <MUNSELL 5Y 8/1>	
External dimension H x W x D	in.	71-5/8 x 48-7/8 x 29-3/16	71-5/8 x 48-7/8 x 29-3/16	
	mm	1,818 x 1,240 x 740	1,818 x 1,240 x 740	
Protection devices	High pressure protection	High pressure sensor, High pressure switch at 4.15 MPa (601 psi)	High pressure sensor, High pressure switch at 4.15 MPa (601 psi)	
	Inverter circuit (COMP./FAN)	Over-current protection		
	Compressor	-		
	Fan motor	-		
Refrigerant	Type x original charge	R410A x 23 lbs + 12 oz (10.8 kg)	R410A x 17 lbs + 10 oz (8.0 kg)	
	Control	Indoor LEV and BC controller		
Net weight	lbs (kg)	715 (324)	657 (298)	
Heat exchanger		Salt-resistant cross fin & aluminium tube		
HIC circuit (HIC: Heat Inter-Changer)		-		
Pipe between unit and distributor	High pressure	in. (mm)	7/8 (22.2) Brazed	
	Low pressure	in. (mm)	1-1/8 (28.58) Brazed	
Defrosting method		Auto-defrost mode (Reversed refrigerant cycle)		
Drawing	External	KL94R885		
	Wiring	KE94G652	KE94G652	
Standard attachment	Document	Installation Manual		
	Accessory	Details refer to External Drw		
Optional parts		Outdoor Twinning kit: CMY-R300NCBK joint: CMY-Y102SS-G2,CMY-Y102LS-G2,CMY-R160-J1 Main BC controller: CMB-P108,1012,1016NU-JA1,CMB-P1016NU-KA1 Sub BC controller: CMB-P104,108NU-KB1		
Remarks		Details on foundation work, duct work, insulation work, electrical wiring, power source switch, and other items shall be referred to the Installation Manual.		

Notes:	Unit converter
1.Nominal cooling conditions (Test conditions are based on AHRI 1230) Indoor: 80°F D.B./67°F W.B. (26.7°C D.B./19.4°C W.B.), Outdoor: 95°F D.B. (35°C D.B.)	BTU/h =kW x 3,412
2.Nominal heating conditions (Test conditions are based on AHRI 1230) Indoor: 70°F D.B. (21.1°C D.B.), Outdoor: 47°F D.B./43°F W.B. (8.3°C D.B./6.1°C W.B.)	cfm =m ³ /min x 35.31
3.Cooling mode/Heating mode	lbs =kg/0.4536
4.External static pressure option is available (0.12 in.WG, 0.24 in.WG, 0.32 in.WG/30 Pa, 60 Pa, 80 Pa).	
Due to continuing improvement, above specifications may be subject to change without notice.	*Above specification data is subject to rounding variation.

1. SPECIFICATIONS

R2-Series (High efficiency)

PURY-EP-T(S)NU-A, Y(S)NU-A

Outdoor Model			PURY-EP288YSNU-A (-BS)		
Indoor Model			Non-Ducted		Ducted
Power source			3-phase 3-wire 460V±10% 60Hz		
Cooling capacity (Nominal)	*1	BTU/h	288,000		
		kW	84.4		
	(460)	Power input	24.83		
		Current input	34.6		
	(Rated)	BTU/h	276,000		
		kW	80.9		
(460)	Power input	28.60	28.45		
	Current input	39.8	39.6		
Temp. range of cooling	Indoor	W.B.	59~75°F (15~24°C)		
	Outdoor	D.B.	23~126°F (-5~52°C)		
Heating capacity (Nominal)	*2	BTU/h	323,000		
		kW	94.7		
	(460)	Power input	27.30		
		Current input	38.0		
	(Rated)	BTU/h	304,000		
		kW	89.1		
(460)	Power input	25.15	25.05		
	Current input	35.0	34.9		
Temp. range of heating	Indoor	D.B.	59~81°F (15~27°C)		
	Outdoor	W.B.	-13~60°F (-25~15.5°C)		
Indoor unit connectable	Total capacity	50~150% of outdoor unit capacity			
	Model/Quantity	P04~P96/2~50			
Sound power level (measured in anechoic room)	*3	dB <A>	88.5/88.5		
Refrigerant piping diameter	High pressure	in. (mm)	1-1/8 (28.58) Brazed		
	Low pressure	in. (mm)	1-3/8 (34.93) Brazed		

Set Model			PURY-EP144YNU-A (-BS)		PURY-EP144YNU-A (-BS)	
Minimum Circuit Ampacity			A	34	34	
Maximum Overcurrent Protection			A	50	50	
FAN	Type x Quantity		Propeller fan x 2		Propeller fan x 2	
	Airflow rate	cfm	9550		9550	
		m ³ /min	270		270	
		L/s	4500		4500	
	Control, Driving mechanism		Inverter-control, Brushless DC motor		Inverter-control, Brushless DC motor	
	Motor output	kW	0.46+0.46		0.46+0.46	
*4	External static press.		0 in.WG (0 Pa)		0 in.WG (0 Pa)	
Compressor	Type x Quantity		Inverter scroll hermetic compressor x 1		Inverter scroll hermetic compressor x 1	
	Starting method		Inverter		Inverter	
	Motor output	kW	9.8		9.8	
	Case heater	kW	-		-	
	Lubricant		MEL32		MEL32	
External finish			Pre-coated galvanized steel sheet (+powder coating for -BS type) <MUNSELL 5Y 8/1>		Pre-coated galvanized steel sheet (+powder coating for -BS type) <MUNSELL 5Y 8/1>	
External dimension H x W x D			in.	71-5/8 x 48-7/8 x 29-3/16	71-5/8 x 48-7/8 x 29-3/16	
			mm	1,818 x 1,240 x 740	1,818 x 1,240 x 740	
Protection devices	High pressure protection		High pressure sensor, High pressure switch at 4.15 MPa (601 psi)		High pressure sensor, High pressure switch at 4.15 MPa (601 psi)	
	Inverter circuit (COMP./FAN)		Over-current protection		Over-current protection	
	Compressor		-		-	
	Fan motor		-		-	
Refrigerant	Type x original charge		R410A x 23 lbs + 12 oz (10.8 kg)		R410A x 23 lbs + 12 oz (10.8 kg)	
	Control		Indoor LEV and BC controller			
Net weight	lbs (kg)	715 (324)		715 (324)		
Heat exchanger			Salt-resistant cross fin & aluminium tube		Salt-resistant cross fin & aluminium tube	
HIC circuit (HIC: Heat Inter-Changer)			-			
Pipe between unit and distributor	High pressure	in. (mm)	7/8 (22.2) Brazed		7/8 (22.2) Brazed	
	Low pressure	in. (mm)	1-1/8 (28.58) Brazed		1-1/8 (28.58) Brazed	
Defrosting method			Auto-defrost mode (Reversed refrigerant cycle)			
Drawing	External		KL94R885			
	Wiring		KE94G652		KE94G652	
Standard attachment	Document		Installation Manual			
	Accessory		Details refer to External Drw			
Optional parts			Outdoor Twinning kit: CMY-R300NCBK joint: CMY-Y102SS-G2, CMY-Y102LS-G2, CMY-R160-J1 Main BC controller: CMB-P108, 1012, 1016NU-JA1, CMB-P1016NU-KA1 Sub BC controller: CMB-P104, 108NU-KB1			
Remarks			Details on foundation work, duct work, insulation work, electrical wiring, power source switch, and other items shall be referred to the Installation Manual.			

Notes:	Unit converter
1. Nominal cooling conditions (Test conditions are based on AHRI 1230) Indoor: 80°F D.B./67°F W.B. (26.7°C D.B./19.4°C W.B.), Outdoor: 95°F D.B. (35°C D.B.)	BTU/h = kW x 3.412
2. Nominal heating conditions (Test conditions are based on AHRI 1230) Indoor: 70°F D.B. (21.1°C D.B.), Outdoor: 47°F D.B./43°F W.B. (8.3°C D.B./6.1°C W.B.)	cfm = m ³ /min x 35.31
3. Cooling mode/Heating mode	lbs = kg/0.4536
4. External static pressure option is available (0.12 in.WG, 0.24 in.WG, 0.32 in.WG/30 Pa, 60 Pa, 80 Pa).	
Due to continuing improvement, above specifications may be subject to change without notice.	*Above specification data is subject to rounding variation.

1. SPECIFICATIONS

R2-Series (High efficiency)

PURY-EP-T(S)NU-A, Y(S)NU-A

Outdoor Model			PURY-EP312YSNU-A (-BS)		
Indoor Model			Non-Ducted		Ducted
Power source			3-phase 3-wire 460V±10% 60Hz		
Cooling capacity (Nominal)	*1	BTU/h	312,000		
		kW	91.4		
	(460)	Power input	27.98		
		Current input	39.0		
	(Rated)	BTU/h	298,000		
		kW	87.3		
(460)	Power input	30.80	30.68		
	Current input	42.9	42.7		
Temp. range of cooling	Indoor	W.B.	59~75°F (15~24°C)		
	Outdoor	D.B.	23~126°F (-5~52°C)		
Heating capacity (Nominal)	*2	BTU/h	350,000		
		kW	102.6		
	(460)	Power input	30.53		
		Current input	42.5		
	(Rated)	BTU/h	334,000		
		kW	97.9		
(460)	Power input	28.35	27.78		
	Current input	39.5	38.7		
Temp. range of heating	Indoor	D.B.	59~81°F (15~27°C)		
	Outdoor	W.B.	-13~60°F (-25~15.5°C)		
Indoor unit connectable	Total capacity	50~150% of outdoor unit capacity			
	Model/Quantity	P04~P96/2~50			
Sound power level (measured in anechoic room)	*3	dB <A>	87.0/88.5		
Refrigerant piping diameter	High pressure	in. (mm)	1-1/8 (28.58) Brazed		
	Low pressure	in. (mm)	1-5/8 (41.28) Brazed		

Set Model			PURY-EP168YNU-A (-BS)		PURY-EP144YNU-A (-BS)	
Model			PURY-EP168YNU-A (-BS)		PURY-EP144YNU-A (-BS)	
Minimum Circuit Ampacity	A		35		34	
Maximum Overcurrent Protection	A		50		50	
FAN	Type x Quantity		Propeller fan x 2		Propeller fan x 2	
	Airflow rate	cfm	14850		9550	
		m ³ /min	420		270	
		L/s	7000		4500	
	Control, Driving mechanism		Inverter-control, Brushless DC motor		Inverter-control, Brushless DC motor	
	Motor output	kW	0.92+0.92		0.46+0.46	
*4	External static press.		0 in.WG (0 Pa)		0 in.WG (0 Pa)	
Compressor	Type x Quantity		Inverter scroll hermetic compressor x 1		Inverter scroll hermetic compressor x 1	
	Starting method		Inverter		Inverter	
	Motor output	kW	12.2		9.8	
	Case heater	kW	-		-	
	Lubricant		MEL32		MEL32	
External finish			Pre-coated galvanized steel sheet (+powder coating for -BS type) <MUNSELL 5Y 8/1>		Pre-coated galvanized steel sheet (+powder coating for -BS type) <MUNSELL 5Y 8/1>	
External dimension H x W x D			in. 71-5/8 x 68-15/16 x 29-3/16		in. 71-5/8 x 48-7/8 x 29-3/16	
			mm 1,818 x 1,750 x 740		mm 1,818 x 1,240 x 740	
Protection devices	High pressure protection		High pressure sensor, High pressure switch at 4.15 MPa (601 psi)		High pressure sensor, High pressure switch at 4.15 MPa (601 psi)	
	Inverter circuit (COMP./FAN)		Over-current protection		Over-current protection	
	Compressor		-		-	
	Fan motor		-		-	
Refrigerant	Type x original charge		R410A x 23 lbs + 12 oz (10.8 kg)		R410A x 23 lbs + 12 oz (10.8 kg)	
	Control		Indoor LEV and BC controller			
Net weight	lbs (kg)	807 (366)		715 (324)		
Heat exchanger			Salt-resistant cross fin & aluminium tube		Salt-resistant cross fin & aluminium tube	
HIC circuit (HIC: Heat Inter-Changer)			-		-	
Pipe between unit and distributor	High pressure	in. (mm)	7/8 (22.2) Brazed		7/8 (22.2) Brazed	
	Low pressure	in. (mm)	1-1/8 (28.58) Brazed		1-1/8 (28.58) Brazed	
Defrosting method			Auto-defrost mode (Reversed refrigerant cycle)			
Drawing	External		KL94R886			
	Wiring		KE94G651		KE94G652	
Standard attachment	Document		Installation Manual			
	Accessory		Details refer to External Drw			
Optional parts			Outdoor Twinning kit: CMY-R300NCBK joint: CMY-Y102SS-G2, CMY-Y102LS-G2, CMY-R160-J1 Main BC controller: CMB-P108, 1012, 1016NU-JA1, CMB-P1016NU-KA1 Sub BC controller: CMB-P104, 108NU-KB1			
Remarks			Details on foundation work, duct work, insulation work, electrical wiring, power source switch, and other items shall be referred to the Installation Manual.			

Notes:	Unit converter
1. Nominal cooling conditions (Test conditions are based on AHRI 1230) Indoor: 80°F D.B./67°F W.B. (26.7°C D.B./19.4°C W.B.), Outdoor: 95°F D.B. (35°C D.B.)	BTU/h = kW x 3,412
2. Nominal heating conditions (Test conditions are based on AHRI 1230) Indoor: 70°F D.B. (21.1°C D.B.), Outdoor: 47°F D.B./43°F W.B. (8.3°C D.B./6.1°C W.B.)	cfm = m ³ /min x 35.31
3. Cooling mode/Heating mode	lbs = kg/0.4536
4. External static pressure option is available (0.12 in.WG, 0.24 in.WG, 0.32 in.WG/30 Pa, 60 Pa, 80 Pa).	
Due to continuing improvement, above specifications may be subject to change without notice.	*Above specification data is subject to rounding variation.

1. SPECIFICATIONS

R2-Series (High efficiency)

PURY-EP-T(S)NU-A, Y(S)NU-A

Outdoor Model			PURY-EP336YSNU-A (-BS)			
Indoor Model			Non-Ducted		Ducted	
Power source			3-phase 3-wire 460V±10% 60Hz			
Cooling capacity (Nominal)	*1	BTU/h	336,000			
		kW	98.5			
	(460)	Power input	31.43			
		Current input	43.8			
	(Rated)	(460)	BTU/h	320,000		
			kW	93.8		
		Power input	33.45	33.32		
		Current input	46.6	46.4		
Temp. range of cooling	Indoor	W.B.	59~75°F (15~24°C)			
	Outdoor	D.B.	23~126°F (-5~52°C)			
Heating capacity (Nominal)	*2	BTU/h	378,000			
		kW	110.8			
	(460)	Power input	33.55			
		Current input	46.7			
	(Rated)	(460)	BTU/h	360,000		
			kW	105.5		
		Power input	31.30	30.20		
		Current input	43.6	42.1		
Temp. range of heating	Indoor	D.B.	59~81°F (15~27°C)			
	Outdoor	W.B.	-13~60°F (-25~15.5°C)			
Indoor unit connectable	Total capacity	50~150% of outdoor unit capacity				
	Model/Quantity	P04~P96/2~50				
Sound power level (measured in anechoic room)	*3	dB <A>	84.5/88.5			
Refrigerant piping diameter	High pressure	in. (mm)	1-1/8 (28.58) Brazed			
	Low pressure	in. (mm)	1-5/8 (41.28) Brazed			

Set Model			PURY-EP168YNU-A (-BS)		PURY-EP168YNU-A (-BS)	
Model			PURY-EP168YNU-A (-BS)		PURY-EP168YNU-A (-BS)	
Minimum Circuit Ampacity	A		35		35	
Maximum Overcurrent Protection	A		50		50	
FAN	Type x Quantity		Propeller fan x 2		Propeller fan x 2	
	Airflow rate	cfm	14850		14850	
		m ³ /min	420		420	
		L/s	7000		7000	
	Control, Driving mechanism		Inverter-control, Brushless DC motor		Inverter-control, Brushless DC motor	
	Motor output	kW	0.92+0.92		0.92+0.92	
*4	External static press.		0 in.WG (0 Pa)		0 in.WG (0 Pa)	
Compressor	Type x Quantity		Inverter scroll hermetic compressor x 1		Inverter scroll hermetic compressor x 1	
	Starting method		Inverter		Inverter	
	Motor output	kW	12.2		12.2	
	Case heater	kW	-		-	
	Lubricant			MEL32		MEL32
External finish			Pre-coated galvanized steel sheet (+powder coating for -BS type) <MUNSELL 5Y 8/1>		Pre-coated galvanized steel sheet (+powder coating for -BS type) <MUNSELL 5Y 8/1>	
External dimension H x W x D			in. 71-5/8 x 68-15/16 x 29-3/16		in. 71-5/8 x 68-15/16 x 29-3/16	
			mm 1,818 x 1,750 x 740		mm 1,818 x 1,750 x 740	
Protection devices	High pressure protection		High pressure sensor, High pressure switch at 4.15 MPa (601 psi)		High pressure sensor, High pressure switch at 4.15 MPa (601 psi)	
	Inverter circuit (COMP./FAN)		Over-current protection		Over-current protection	
	Compressor		-		-	
	Fan motor		-		-	
Refrigerant	Type x original charge		R410A x 23 lbs + 12 oz (10.8 kg)		R410A x 23 lbs + 12 oz (10.8 kg)	
	Control		Indoor LEV and BC controller			
Net weight	lbs (kg)		807 (366)		807 (366)	
Heat exchanger			Salt-resistant cross fin & aluminium tube		Salt-resistant cross fin & aluminium tube	
HIC circuit (HIC: Heat Inter-Changer)						
Pipe between unit and distributor	High pressure		in. (mm) 7/8 (22.2) Brazed		in. (mm) 7/8 (22.2) Brazed	
	Low pressure		in. (mm) 1-1/8 (28.58) Brazed		in. (mm) 1-1/8 (28.58) Brazed	
Defrosting method			Auto-defrost mode (Reversed refrigerant cycle)			
Drawing	External		KL94R887			
	Wiring		KE94G651		KE94G651	
Standard attachment	Document		Installation Manual			
	Accessory		Details refer to External Drw			
Optional parts			Outdoor Twinning kit: CMY-R300NCBK joint: CMY-Y102SS-G2, CMY-Y102LS-G2, CMY-R160-J1 Main BC controller: CMB-P108, 1012, 1016NU-JA1, CMB-P1016NU-KA1 Sub BC controller: CMB-P104, 108NU-KB1			
Remarks			Details on foundation work, duct work, insulation work, electrical wiring, power source switch, and other items shall be referred to the Installation Manual.			

Notes:	Unit converter
1. Nominal cooling conditions (Test conditions are based on AHRI 1230) Indoor: 80°F D.B./67°F W.B. (26.7°C D.B./19.4°C W.B.), Outdoor: 95°F D.B. (35°C D.B.)	BTU/h = kW x 3.412
2. Nominal heating conditions (Test conditions are based on AHRI 1230) Indoor: 70°F D.B. (21.1°C D.B.), Outdoor: 47°F D.B./43°F W.B. (8.3°C D.B./6.1°C W.B.)	cfm = m ³ /min x 35.31
3. Cooling mode/Heating mode	lbs = kg/0.4536
4. External static pressure option is available (0.12 in.WG, 0.24 in.WG, 0.32 in.WG/30 Pa, 60 Pa, 80 Pa).	
Due to continuing improvement, above specifications may be subject to change without notice.	*Above specification data is subject to rounding variation.

1. SPECIFICATIONS

R2-Series (High efficiency)

PURY-EP-T(S)NU-A, Y(S)NU-A

Outdoor Model			PURY-EP384YSNU-A (-BS)		
Indoor Model			Non-Ducted		Ducted
Power source			3-phase 3-wire 460V±10% 60Hz		
Cooling capacity (Nominal)	*1	BTU/h	384,000		
		kW	112.5		
	(460)	Power input	36.62		
		Current input	51.0		
	(Rated)	BTU/h	364,000		
		kW	106.7		
(460)	Power input	39.05	38.27		
	Current input	54.4	53.3		
Temp. range of cooling	Indoor	W.B.	59~75°F (15~24°C)		
	Outdoor	D.B.	23~126°F (-5~52°C)		
Heating capacity (Nominal)	*2	BTU/h	430,000		
		kW	126.0		
	(460)	Power input	38.66		
		Current input	53.9		
	(Rated)	BTU/h	410,000		
		kW	120.2		
(460)	Power input	36.47	34.75		
	Current input	50.8	48.4		
Temp. range of heating	Indoor	D.B.	59~81°F (15~27°C)		
	Outdoor	W.B.	-13~60°F (-25~15.5°C)		
Indoor unit connectable	Total capacity	50~150% of outdoor unit capacity			
	Model/Quantity	P04~P96/2~50			
Sound power level (measured in anechoic room)	*3	dB <A>	86.5/89.0		
Refrigerant piping diameter	High pressure	in. (mm)	1-1/8 (28.58) Brazed		
	Low pressure	in. (mm)	1-5/8 (41.28) Brazed		

Set Model			PURY-EP192YNU-A (-BS)		PURY-EP192YNU-A (-BS)	
Model			PURY-EP192YNU-A (-BS)		PURY-EP192YNU-A (-BS)	
Minimum Circuit Ampacity	A		38		38	
Maximum Overcurrent Protection	A		60		60	
FAN	Type x Quantity		Propeller fan x 2		Propeller fan x 2	
	Airflow rate	cfm	13050		13050	
		m ³ /min	370		370	
		L/s	6170		6170	
	Control, Driving mechanism		Inverter-control, Brushless DC motor		Inverter-control, Brushless DC motor	
	Motor output	kW	0.92+0.92		0.92+0.92	
*4	External static press.		0 in.WG (0 Pa)		0 in.WG (0 Pa)	
Compressor	Type x Quantity		Inverter scroll hermetic compressor x 1		Inverter scroll hermetic compressor x 1	
	Starting method		Inverter		Inverter	
	Motor output	kW	13.2		13.2	
	Case heater	kW	-		-	
	Lubricant		MEL32		MEL32	
External finish			Pre-coated galvanized steel sheet (+powder coating for -BS type) <MUNSELL 5Y 8/1>		Pre-coated galvanized steel sheet (+powder coating for -BS type) <MUNSELL 5Y 8/1>	
External dimension H x W x D			in. 71-5/8 x 68-15/16 x 29-3/16		71-5/8 x 68-15/16 x 29-3/16	
			mm 1,818 x 1,750 x 740		1,818 x 1,750 x 740	
Protection devices	High pressure protection		High pressure sensor, High pressure switch at 4.15 MPa (601 psi)		High pressure sensor, High pressure switch at 4.15 MPa (601 psi)	
	Inverter circuit (COMP./FAN)		Over-current protection		Over-current protection	
	Compressor		-		-	
	Fan motor		-		-	
Refrigerant	Type x original charge		R410A x 26 lbs + 1 oz (11.8 kg)		R410A x 26 lbs + 1 oz (11.8 kg)	
	Control		Indoor LEV and BC controller			
Net weight	lbs (kg)	918 (416)		918 (416)		
Heat exchanger			Salt-resistant cross fin & aluminium tube		Salt-resistant cross fin & aluminium tube	
HIC circuit (HIC: Heat Inter-Changer)			-		-	
Pipe between unit and distributor	High pressure	in. (mm)	7/8 (22.2) Brazed		7/8 (22.2) Brazed	
	Low pressure	in. (mm)	1-1/8 (28.58) Brazed		1-1/8 (28.58) Brazed	
Defrosting method			Auto-defrost mode (Reversed refrigerant cycle)			
Drawing	External		KB94C1J7			
	Wiring		KE94G983		KE94G983	
Standard attachment	Document		Installation Manual			
	Accessory		Details refer to External Drw			
Optional parts			Outdoor Twinning kit: CMY-R300NCBK joint: CMY-Y102SS-G2,CMY-Y102LS-G2,CMY-R160-J1 Main BC controller: CMB-P1016NU-KA1 Sub BC controller: CMB-P104,108NU-KB1			
Remarks			Details on foundation work, duct work, insulation work, electrical wiring, power source switch, and other items shall be referred to the Installation Manual.			

Notes:	Unit converter
1.Nominal cooling conditions (Test conditions are based on AHRI 1230) Indoor: 80°F D.B./67°F W.B. (26.7°C D.B./19.4°C W.B.), Outdoor: 95°F D.B. (35°C D.B.)	BTU/h =kW x 3,412
2.Nominal heating conditions (Test conditions are based on AHRI 1230) Indoor: 70°F D.B. (21.1°C D.B.), Outdoor: 47°F D.B./43°F W.B. (8.3°C D.B./6.1°C W.B.)	cfm =m ³ /min x 35.31
3.Cooling mode/Heating mode	lbs =kg/0.4536
4.External static pressure option is available (0.12 in.WG, 0.24 in.WG, 0.32 in.WG/30 Pa, 60 Pa, 80 Pa).	
Due to continuing improvement, above specifications may be subject to change without notice.	*Above specification data is subject to rounding variation.

1. SPECIFICATIONS

R2-Series (High efficiency)

PURY-EP-T(S)NU-A, Y(S)NU-A

Outdoor Model			PURY-EP432YSNU-A (-BS)			
Indoor Model			Non-Ducted		Ducted	
Power source			3-phase 3-wire 460V±10% 60Hz			
Cooling capacity (Nominal)	*1	BTU/h	432,000			
		kW	126.6			
	(460)	Power input	42.36			
		Current input	59.0			
	(Rated)	(460)	BTU/h	410,000		
			kW	120.2		
		Power input	44.40	43.98		
		Current input	61.9	61.3		
Temp. range of cooling	Indoor	W.B.	59~75°F (15~24°C)			
	Outdoor	D.B.	23~126°F (-5~52°C)			
Heating capacity (Nominal)	*2	BTU/h	480,000			
		kW	140.7			
	(460)	Power input	43.14			
		Current input	60.1			
	(Rated)	(460)	BTU/h	455,000		
			kW	133.4		
		Power input	40.70	38.90		
		Current input	56.7	54.2		
Temp. range of heating	Indoor	D.B.	59~81°F (15~27°C)			
	Outdoor	W.B.	-13~60°F (-25~15.5°C)			
Indoor unit connectable	Total capacity	50~150% of outdoor unit capacity				
	Model/Quantity	P04~P96/2~50				
Sound power level (measured in anechoic room)	*3	dB <A>	89.0/89.0			
Refrigerant piping diameter	High pressure	in. (mm)	1-1/8 (28.58) Brazed			
	Low pressure	in. (mm)	1-5/8 (41.28) Brazed			

Set Model			PURY-EP216YNU-A (-BS)		PURY-EP216YNU-A (-BS)	
Model			PURY-EP216YNU-A (-BS)		PURY-EP216YNU-A (-BS)	
Minimum Circuit Ampacity	A		41		41	
Maximum Overcurrent Protection	A		70		70	
FAN	Type x Quantity		Propeller fan x 2		Propeller fan x 2	
	Airflow rate	cfm	14100		14100	
		m ³ /min	400		400	
		L/s	6670		6670	
	Control, Driving mechanism		Inverter-control, Brushless DC motor		Inverter-control, Brushless DC motor	
	Motor output	kW	0.92+0.92		0.92+0.92	
*4	External static press.		0 in.WG (0 Pa)		0 in.WG (0 Pa)	
Compressor	Type x Quantity		Inverter scroll hermetic compressor x 1		Inverter scroll hermetic compressor x 1	
	Starting method		Inverter		Inverter	
	Motor output	kW	15.8		15.8	
	Case heater	kW	-		-	
	Lubricant			MEL32		MEL32
External finish			Pre-coated galvanized steel sheet (+powder coating for -BS type) <MUNSELL 5Y 8/1>		Pre-coated galvanized steel sheet (+powder coating for -BS type) <MUNSELL 5Y 8/1>	
External dimension H x W x D			in. 71-5/8 x 68-15/16 x 29-3/16		in. 71-5/8 x 68-15/16 x 29-3/16	
			mm 1,818 x 1,750 x 740		mm 1,818 x 1,750 x 740	
Protection devices	High pressure protection		High pressure sensor, High pressure switch at 4.15 MPa (601 psi)		High pressure sensor, High pressure switch at 4.15 MPa (601 psi)	
	Inverter circuit (COMP./FAN)		Over-current protection		Over-current protection	
	Compressor		-		-	
	Fan motor		-		-	
Refrigerant	Type x original charge		R410A x 26 lbs + 1 oz (11.8 kg)		R410A x 26 lbs + 1 oz (11.8 kg)	
	Control		Indoor LEV and BC controller			
Net weight	lbs (kg)		918 (416)		918 (416)	
Heat exchanger			Salt-resistant cross fin & aluminium tube		Salt-resistant cross fin & aluminium tube	
HIC circuit (HIC: Heat Inter-Changer)			-			
Pipe between unit and distributor	High pressure	in. (mm)	7/8 (22.2) Brazed		7/8 (22.2) Brazed	
	Low pressure	in. (mm)	1-1/8 (28.58) Brazed		1-1/8 (28.58) Brazed	
Defrosting method			Auto-defrost mode (Reversed refrigerant cycle)			
Drawing	External		KB94C1J7			
	Wiring		KE94G983		KE94G983	
Standard attachment	Document		Installation Manual			
	Accessory		Details refer to External Drw			
Optional parts			Outdoor Twinning kit: CMY-R300NCBK joint: CMY-Y102SS-G2, CMY-Y102LS-G2, CMY-R160-J1 Main BC controller: CMB-P1016NU-KA1 Sub BC controller: CMB-P104, 108NU-KB1			
Remarks			Details on foundation work, duct work, insulation work, electrical wiring, power source switch, and other items shall be referred to the Installation Manual.			

Notes:		Unit converter
1. Nominal cooling conditions (Test conditions are based on AHRI 1230) Indoor: 80°F D.B./67°F W.B. (26.7°C D.B./19.4°C W.B.), Outdoor: 95°F D.B. (35°C D.B.)		BTU/h = kW x 3.412
2. Nominal heating conditions (Test conditions are based on AHRI 1230) Indoor: 70°F D.B. (21.1°C D.B.), Outdoor: 47°F D.B./43°F W.B. (8.3°C D.B./6.1°C W.B.)		cfm = m ³ /min x 35.31
3. Cooling mode/Heating mode		lbs = kg/0.4536
4. External static pressure option is available (0.12 in.WG, 0.24 in.WG, 0.32 in.WG/30 Pa, 60 Pa, 80 Pa).		
Due to continuing improvement, above specifications may be subject to change without notice.		*Above specification data is subject to rounding variation.

PURY-EP72TNU-A-(BS)

Unit: mm(in)

Note 1. Please refer to the next page for information regarding necessary spacing around the unit and foundation work.
 2. At brazing of pipes, wrap the refrigerant service valve with wet cloth and keep the temperature of refrigerant service valve under 120°C(248°F).

PURY-EP-T(S)NU-A, Y(S)NU-A

Connecting pipe specifications

Model	Refrigerant pipe		Service valve	
	High pressure	Low pressure	High pressure	Low pressure
EP72	φ15.88(5/8) Brazed *1	φ19.05(3/4) Brazed *1	φ22.2(7/8)	φ23.5(1-1/8)

*1 Connect the refrigerant pipe to the service valve according to the Installation Manual.

NO.	Usage	Specifications
①	Front through hole	148(5-7/8) × 84(3-5/16) Knockout hole
②	Bottom through hole	150(5-15/16) × 94(3-3/4) Knockout hole
③	Front through hole	φ62.7(2-1/2) or φ34.5(1-3/8) Knockout hole
④	Front through hole	φ43.7(1-3/4) or φ22.2(7/8) Knockout hole
⑤	Bottom through hole	φ52(2-9/16) Knockout hole
⑥	Bottom through hole	φ52(2-1/16) Knockout hole
⑦	Front through hole	φ34(1-3/8) Knockout hole
⑧	Bottom through hole	φ34(1-3/8) Knockout hole

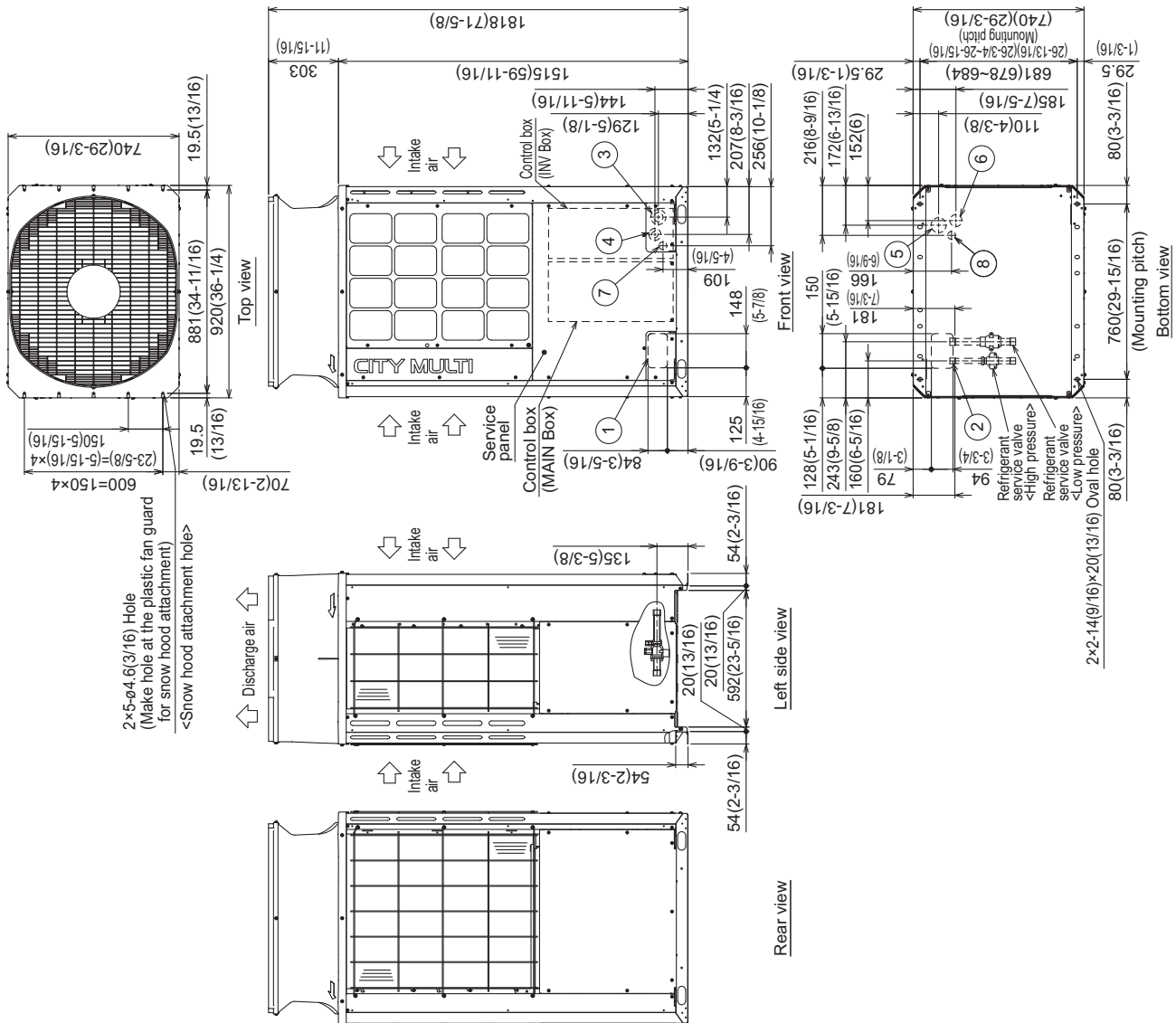

Unit: mm(in)

PURY-EP72TNU-A(-BS)

1. Required space around the unit

● In case of single installation

- Secure enough space around the unit as shown in the figure below.
 - With a space of at least 300mm(11-13/16) to the wall on the back of the unit
- When the height of the walls on the front, back or on the sides <H> exceeds the wall height limit as defined below add the height that exceeds the height limit <h> to the figures that are marked with an asterisk.

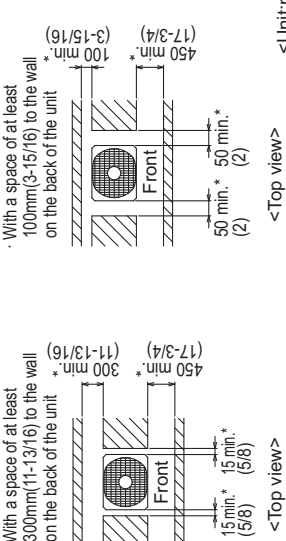

● In case of collective installation

- When multiple units are installed adjacent to each other, secure enough space to allow for air circulation and walkway between groups of units as shown in the figures below.
- At least two sides must be left open.
- As with the single installation, add the height that exceeds the height limit <h> to the figures that are marked with an asterisk.
- If there is a wall at both the front and the rear of the unit, install up to six units consecutively in the side direction and provide a space of 1000mm(39-3/8) or more as inlet space/ passage space for each six units.

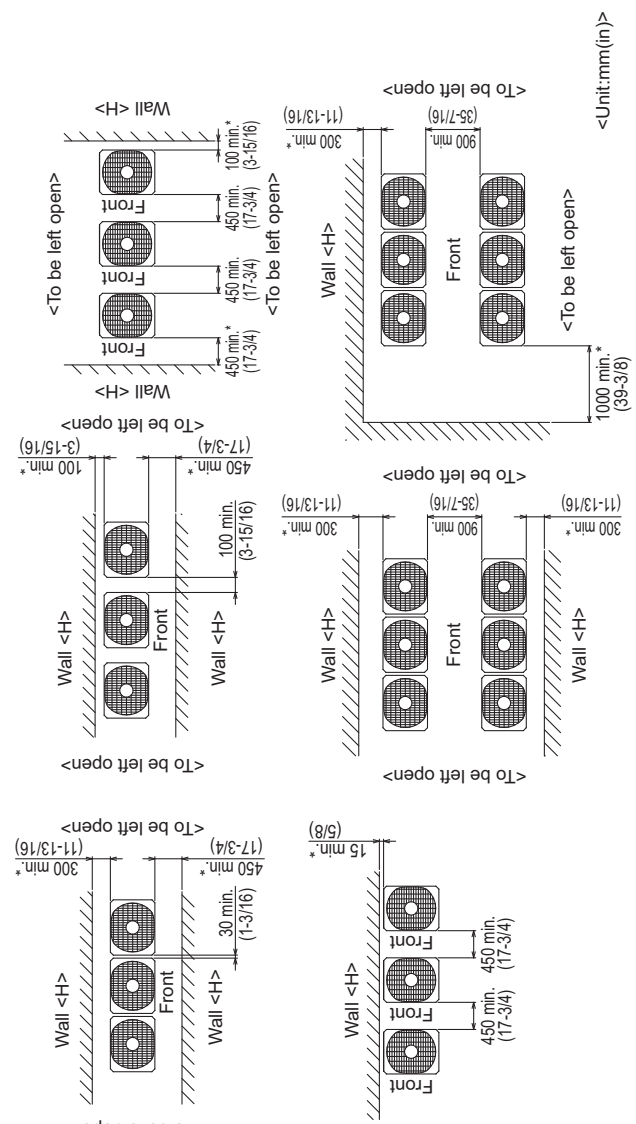

2. Foundation work

- Take into consideration the surface strength, water drainage route, piping route, and wiring route when preparing the installation site.
 - Note that the drain water comes out of the unit during operation.
- Build the foundation in such way that the corner of the installation leg is securely supported as shown in the right figure.(Fig.A)
 - When using a rubber isolating cushion, please ensure it is large enough to cover the entire width of each of the unit's legs.
- The protrusion length of the anchor bolt must not exceed 30mm(1-3/16).(Fig.A)
- Use four fixing plates as shown in the right figure <field supply required> when using M12 hole-in anchor bolts <field supply required> (Fig.B)
- To prevent small animals and water and snow from entering the unit and damaging its parts, close the gap around the edges of through holes for pipes and wires with filler plates <field supply required>.
- When the pipes or cables are routed at the bottom of the unit, make sure that the through hole at the base of the unit does not get blocked with the installation base.
- Refer to the Installation Manual when installing units on an installation base.

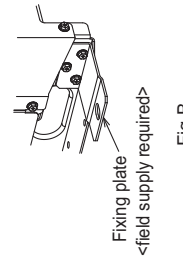
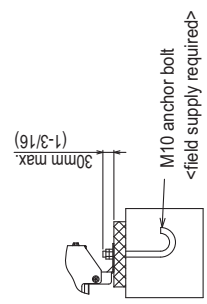

PURY-EP96, 120, 144TNU-A(-BS)

Unit: mm(in)

Note 1. Please refer to the next page for information regarding necessary spacing around the unit and foundation work.
 2. At brazing of pipes, wrap the refrigerant service valve with wet cloth and keep the temperature of refrigerant service valve under 120°C(248°F).

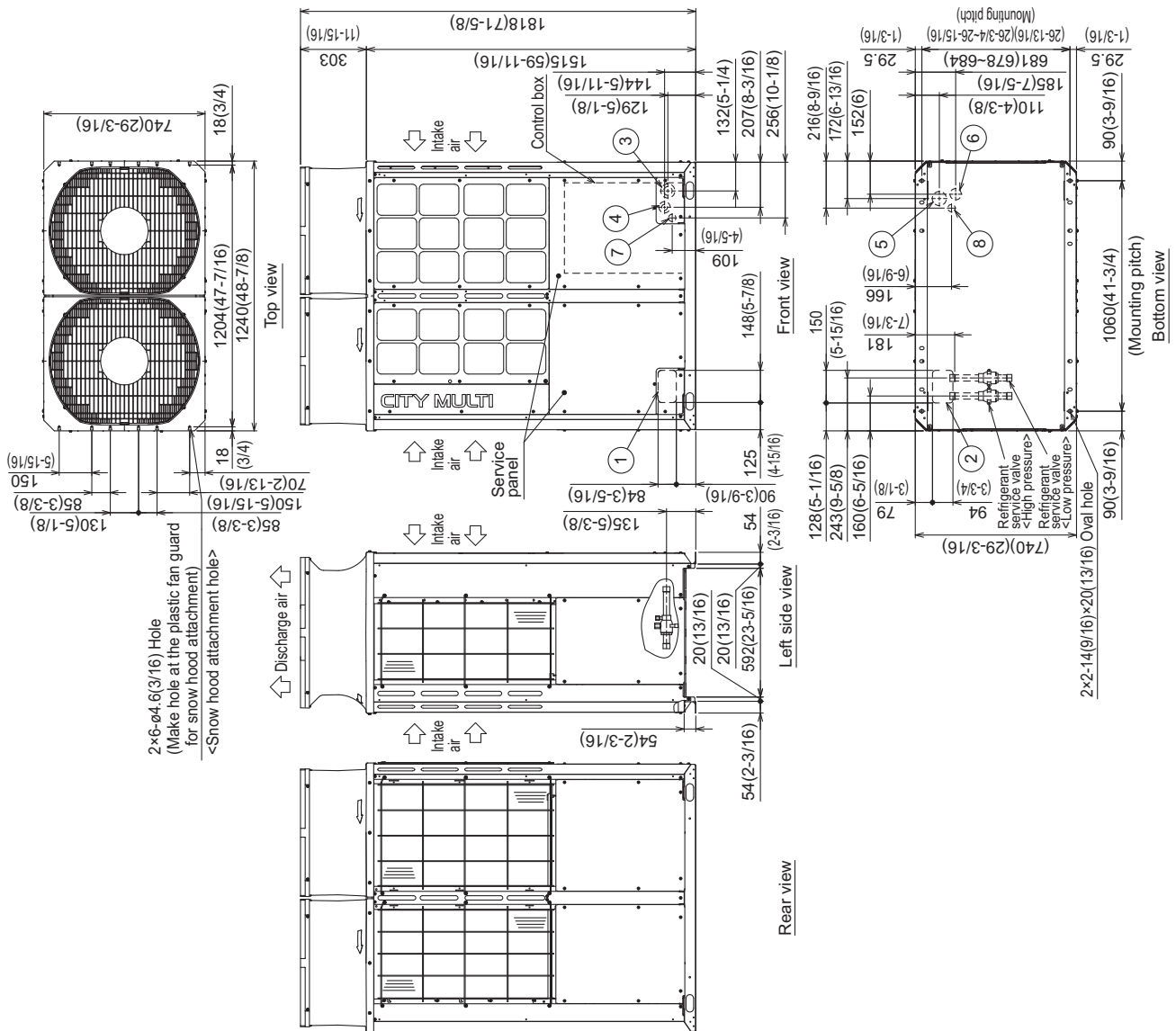

Connecting pipe specifications

Model	Refrigerant pipe		Service valve	
	High pressure	Low pressure	High pressure	Low pressure
EP96	φ19(3/4) Brazed *1	φ22(7/8) Brazed *1	φ23.58(1-1/8)	φ23.58(1-1/8)
EP120	φ19(3/4) Brazed *1	φ22(7/8) Brazed *1	φ23.58(1-1/8)	φ23.58(1-1/8)
EP144	φ19(3/4) Brazed *1	φ22(7/8) Brazed *1	φ23.58(1-1/8)	φ23.58(1-1/8)

*1 Connect the refrigerant pipe to the service valve according to the Installation Manual.

NO.	Usage	Specifications
①	For pipes	Front through hole 148(5-7/8) × 84(3-5/16) Knockout hole
②		Bottom through hole 150(5-15/16) × 94(3-3/4) Knockout hole
③	For wires	Front through hole φ62.7(2-1/2) or φ34.5(1-3/8) Knockout hole
④		Front through hole φ43.7(1-3/4) or φ22.2(7/8) Knockout hole
⑤	For transmission cables	Bottom through hole φ65(2-9/16) Knockout hole
⑥		Bottom through hole φ52(2-1/16) Knockout hole
⑦	For transmission cables	Front through hole φ34(1-3/8) Knockout hole
⑧		Bottom through hole φ34(1-3/8) Knockout hole

PURY-EP96, 120, 144TNU-A(-BS)

Unit: mm(in)

1. Required space around the unit

● In case of single installation

- Secure enough space around the unit as shown in the figure below.
 - With a space of at least 300mm(11-13/16) to the wall on the back of the unit
 - With a space of at least 100mm(3-15/16) to the wall on the back of the unit
- When the height of the walls on the front, back or on the sides<h> exceeds the wall height limit as defined below add the height that exceeds the height limit <h> to the figures that are marked with an asterisk.

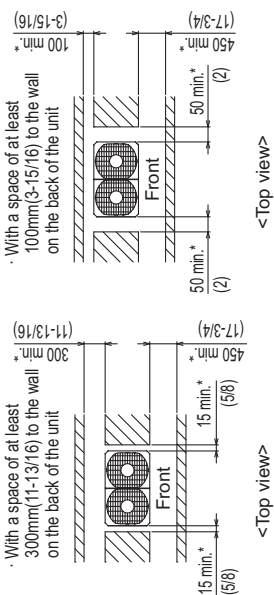

● In case of collective installation

- When multiple units are installed adjacent to each other, secure enough space to allow for air circulation and walkway between groups of units as shown in the figures below.
- At least two sides must be left open.
- As with the single installation, add the height that exceeds the height limit<h> to the figures that are marked with an asterisk.
- If there is a wall at both the front and the rear of the unit, install up to six units consecutively in the side direction and provide a space of 1000mm(39-3/8) or more as inlet space/ passage space for each six units.

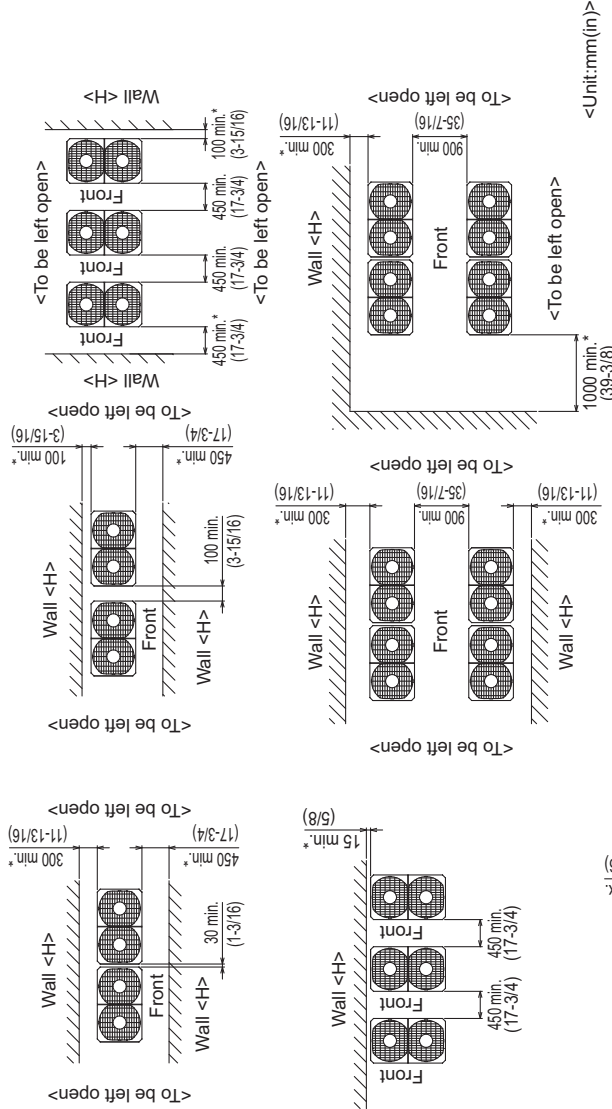

2. Foundation work

- Take into consideration the surface strength, water drainage route, piping route, and wiring route when preparing the installation site.
 - Note that the drain water comes out of the unit during operation >
- Build the foundation in such way that the corner of the installation leg is securely supported as shown in the right figure.(Fig.A)
 - When using a rubber isolating cushion, please ensure it is large enough to cover the entire width of each of the unit's legs.
- The protrusion length of the anchor bolt must not exceed 30mm(1-3/16).(Fig.A)
- Use four fixing plates as shown in the right figure <field supply required> when using M12 hole-in anchor bolts <field supply required>.(Fig.B)
- To prevent small animals and water and snow from entering the unit and damaging its parts, close the gap around the edges of through holes for pipes and wires with filler plates <field supply required>.
- When the pipes or cables are routed at the bottom of the unit, make sure that the through hole at the base of the unit does not get blocked with the installation base.
- Refer to the Installation Manual when installing units on an installation base.

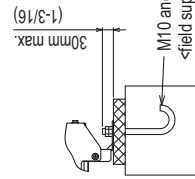

Fig.A

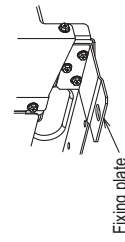
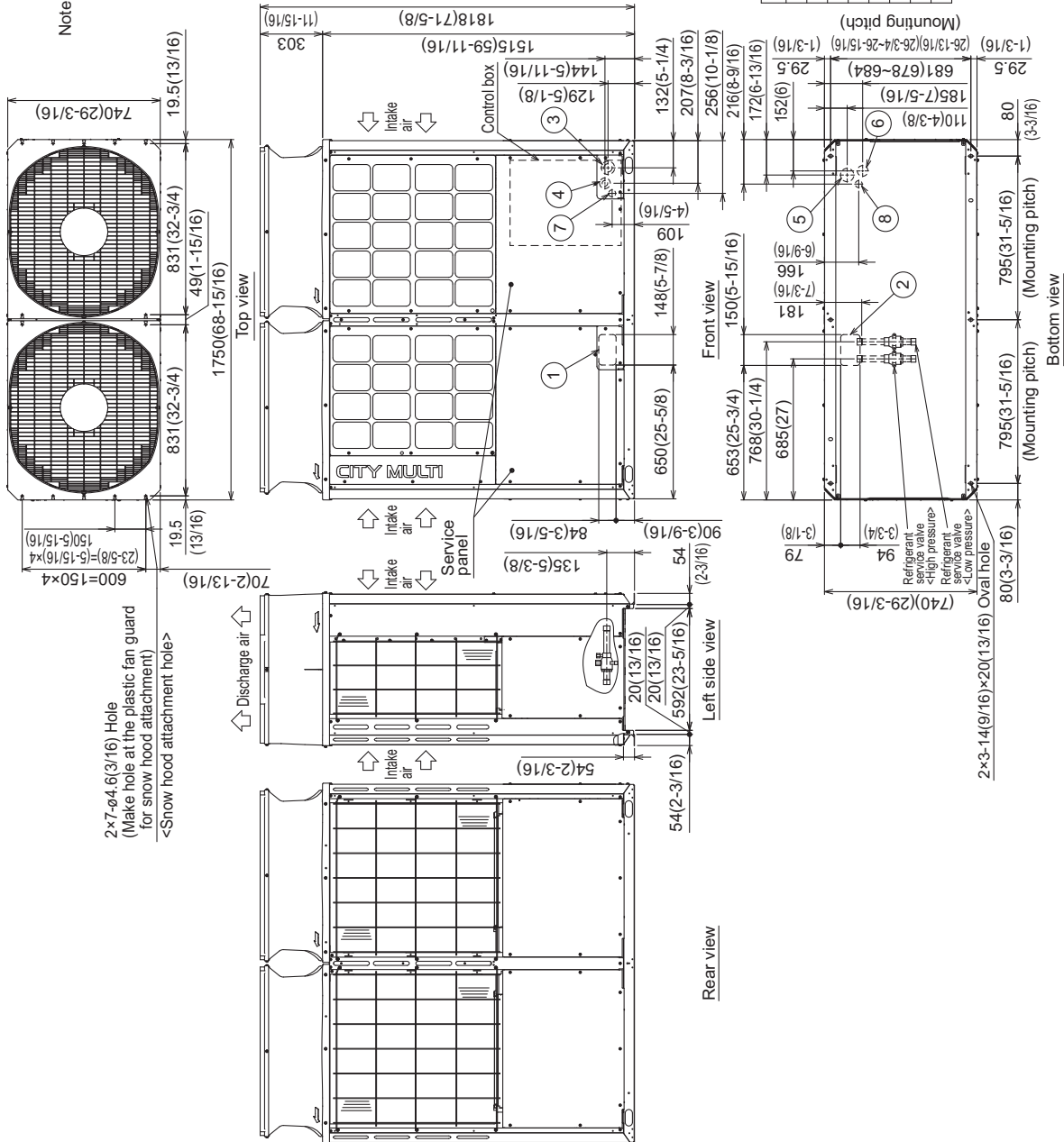

Fig.B

PURY-EP168TNU-A(-BS)

Unit: mm(in)



Note 1. Please refer to the next page for information regarding necessary spacing around the unit and foundation work.
 2. At brazing of pipes, wrap the refrigerant service valve with wet cloth and keep the temperature of refrigerant service valve under 120°C(248°F).

Connecting pipe specifications

Model	Refrigerant pipe		Service valve	
	High pressure	Low pressure	High pressure	Low pressure
EP168	φ22.2(7/8) Braze*1	φ28.5(1-1/8) Braze*1	φ28.5(1-1/8)	φ28.5(1-1/8)

*1 Connect the refrigerant pipe to the service valve according to the Installation Manual.

NO.	Usage	Specifications
①	For pipes	Front through hole 148(5-7/8) × 84(3-5/16) Knockout hole
②		Bottom through hole 150(5-15/16) × 94(3-3/4) Knockout hole
③	For wires	Front through hole φ62.7(2-1/2) or φ34.5(1-3/8) Knockout hole
④		Front through hole φ43.7(1-3/4) or φ22.2(7/8) Knockout hole
⑤	For transmission cables	Bottom through hole φ52(2-9/16) Knockout hole
⑥		Bottom through hole φ52(2-9/16) Knockout hole
⑦	For transmission cables	Front through hole φ34(1-3/8) Knockout hole
⑧		Bottom through hole φ34(1-3/8) Knockout hole

2x7-φ4.6(3/16) Hole
 (Make hole at the plastic fan guard for snow hood attachment)
 <Snow hood attachment hole>

Refrigerant service valve <High pressure>
 Refrigerant service valve <Low pressure>

PURY-EP168TNU-A(-BS)

Unit: mm(in)

1. Required space around the unit

● In case of single installation

- ① Secure enough space around the unit as shown in the figure below.

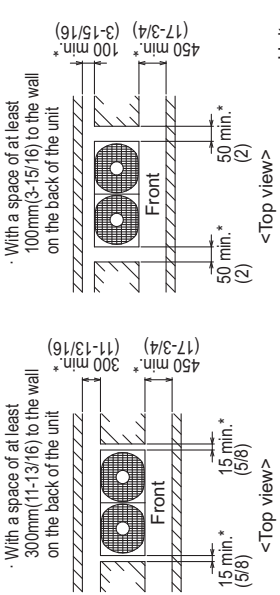

- ② When the height of the walls on the front, back or on the sides <H> exceeds the wall height limit as defined below add the height that exceeds the height limit <h> to the figures that are marked with an asterisk.

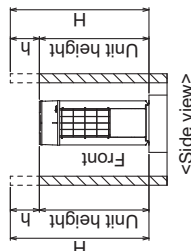

<Wall height limit> Front : Up to the unit height
Back : Up to the unit height
Side : Up to the unit height

2. Foundation work

- ① Take into consideration the surface strength, water drainage route, piping route, and wiring route when preparing the installation site.
<Note that the drain water comes out of the unit during operation.>
- ② Build the foundation in such way that the corner of the installation leg is securely supported as shown in the right figure.(Fig.A)
When using a rubber isolating cushion, please ensure it is large enough to cover the entire width of each of the unit's legs.
- ③ The protrusion length of the anchor bolt must not exceed 30mm(1-3/16).(Fig.A)
- ④ Use six fixing plates as shown in the right figure <field supply required> when using M12 hole-in anchor bolts <field supply required> (Fig.B)
- ⑤ To prevent small animals and water and snow from entering the unit and damaging its parts, close the gap around the edges of through holes for pipes and wires with filler plates <field supply required>.
- ⑥ When the pipes or cables are routed at the bottom of the unit, make sure that the through hole at the base of the unit does not get blocked with the installation base.
- ⑦ Refer to the Installation Manual when installing units on an installation base.

● In case of collective installation

- ① When multiple units are installed adjacent to each other, secure enough space to allow for air circulation and walkway between groups of units as shown in the figures below.
- ② At least two sides must be left open.
- ③ As with the single installation, add the height that exceeds the height limit <h> to the figures that are marked with an asterisk.
- ④ If there is a wall at both the front and the rear of the unit, install up to three units consecutively in the side direction and provide a space of 1000mm(39-3/8) or more as inlet space/ passage space for each three units.

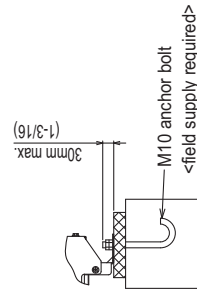
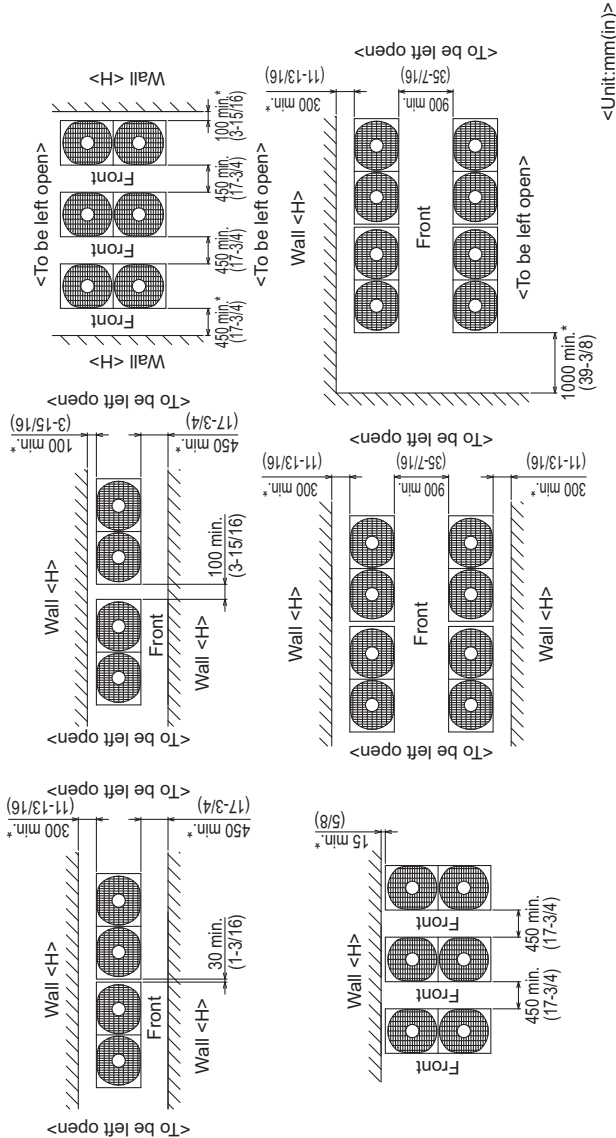

Fig.A

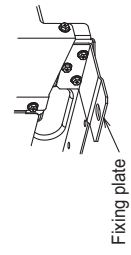
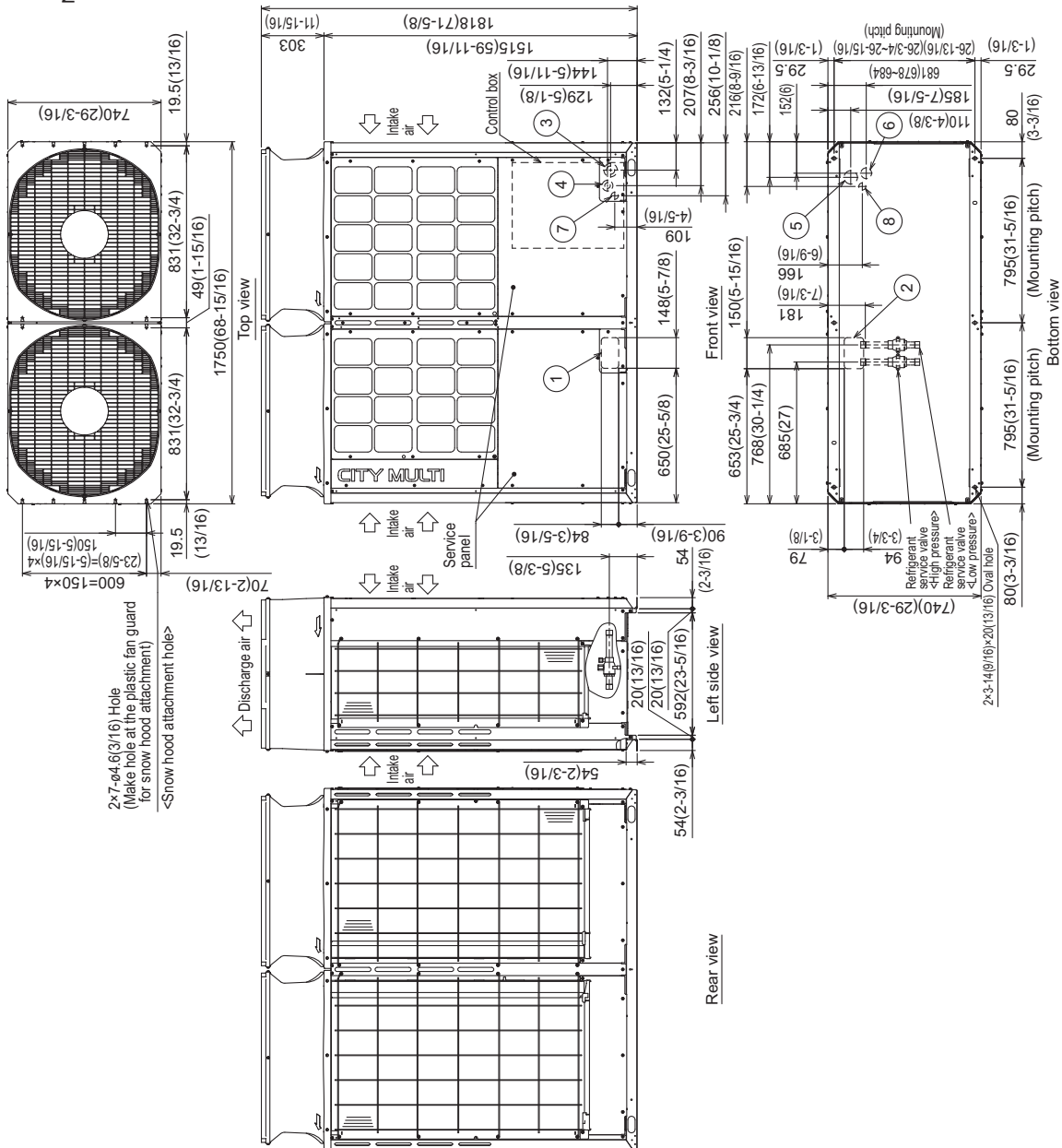

Fig.B

PURY-EP192, 216, 240TNU-A(-BS)

Unit: mm (in.)

Note 1. Please refer to the next page for information regarding necessary spacing around the unit and foundation work.
 2. At brazing of pipes, wrap the refrigerant service valve with wet cloth and keep the temperature of refrigerant service valve under 120 °C(248 °F).



Connecting pipe specifications

Model	Refrigerant pipe		Service valve	
	High pressure	Low pressure	High pressure	Low pressure
EP192	ø22.2(7/8) Brazed *1	ø28.58(1-1/8) Brazed	ø28.58(1-1/8)	ø28.58(1-1/8)
EP216	ø22.2(7/8) Brazed *1,2	ø34.93(1-3/8) Brazed *1	ø28.58(1-1/8)	ø28.58(1-1/8)
EP240	ø22.2(7/8) Brazed *1,2	ø34.93(1-3/8) Brazed *1	ø28.58(1-1/8)	ø28.58(1-1/8)

*1 Connect the refrigerant pipe to the service valve according to the Installation Manual.
 *2 When the piping length is 65m(213ft) or longer, use the ø28.58(1-1/8) pipe for the part that exceeds 65m(213ft).

NO.	Usage	Specifications
①	Front through hole	148(6-7/8) × 84(3-5/16) Knockout hole
②	Bottom through hole	150(6-15/16) × 94(3-3/4) Knockout hole
③	Front through hole	ø62.7(2-1/2) or ø34.5(1-3/8) Knockout hole
④	Front through hole	ø43.7(1-3/4) or ø22.2(7/8) Knockout hole
⑤	Bottom through hole	ø65(2-9/16) Knockout hole
⑥	Bottom through hole	ø52(2-1/16) Knockout hole
⑦	Front through hole	ø34(1-3/8) Knockout hole
⑧	Bottom through hole	ø34(1-3/8) Knockout hole

PURY-EP192, 216, 240TNU-A(-BS)

Unit: mm (in.)

1. Required space around the unit

● In case of single installation

- Secure enough space around the unit as shown in the figure below.
 - With a space of at least 300mm(11-13/16) to the wall on the back of the unit

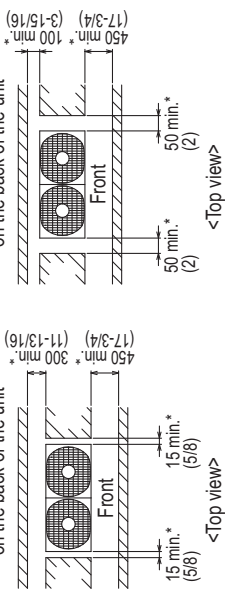

- When the height of the walls on the front, back or on the sides <H> exceeds the wall height limit as defined below add the height that exceeds the height limit <h> to the figures that are marked with an asterisk.

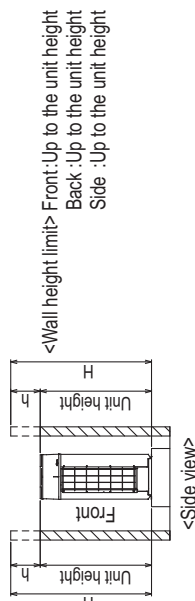

2. Foundation work

- Take into consideration the surface strength, water drainage route, piping route, and wiring route when preparing the installation site.
 - Note that the drain water comes out of the unit during operation. >
- Build the foundation in such way that the corner of the installation leg is securely supported as shown in the right figure. (Fig.A)
 - When using a rubber isolating cushion, please ensure it is large enough to cover the entire width of each of the unit's legs.
- The protrusion length of the anchor bolt must not exceed 30mm(1-3/16) (Fig.A)
- Use six fixing plates as shown in the right figure <field supply required> when using M12 hole-in anchor bolts <field supply required> (Fig.B)
 - close the gap around the edges of through holes for pipes and wires with filler plates <field supply required>.
- To prevent small animals and water and snow from entering the unit and damaging its parts, make sure that the through hole at the base of the unit does not get blocked with the installation base.
- Refer to the Installation Manual when installing units on an installation base.

● In case of collective installation

- When multiple units are installed adjacent to each other, secure enough space to allow for air circulation and walkway between groups of units as shown in the figures below.
- At least two sides must be left open.
- As with the single installation, add the height that exceeds the height limit <h> to the figures that are marked with an asterisk.
- If there is a wall at both the front and the rear of the unit, install up to three units consecutively in the side direction and provide a space of 1000mm(39-3/8) or more as inlet space/ passage space for each three units.

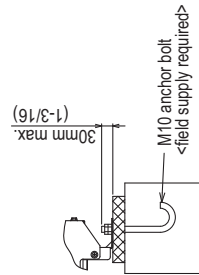
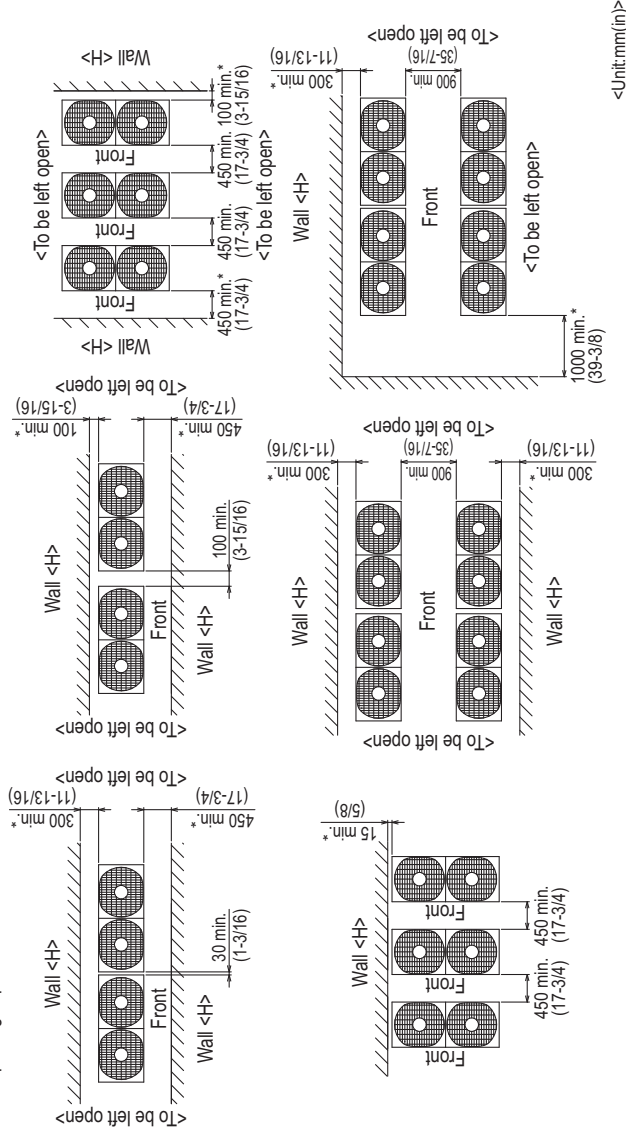

Fig.A

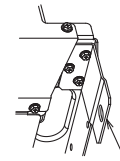
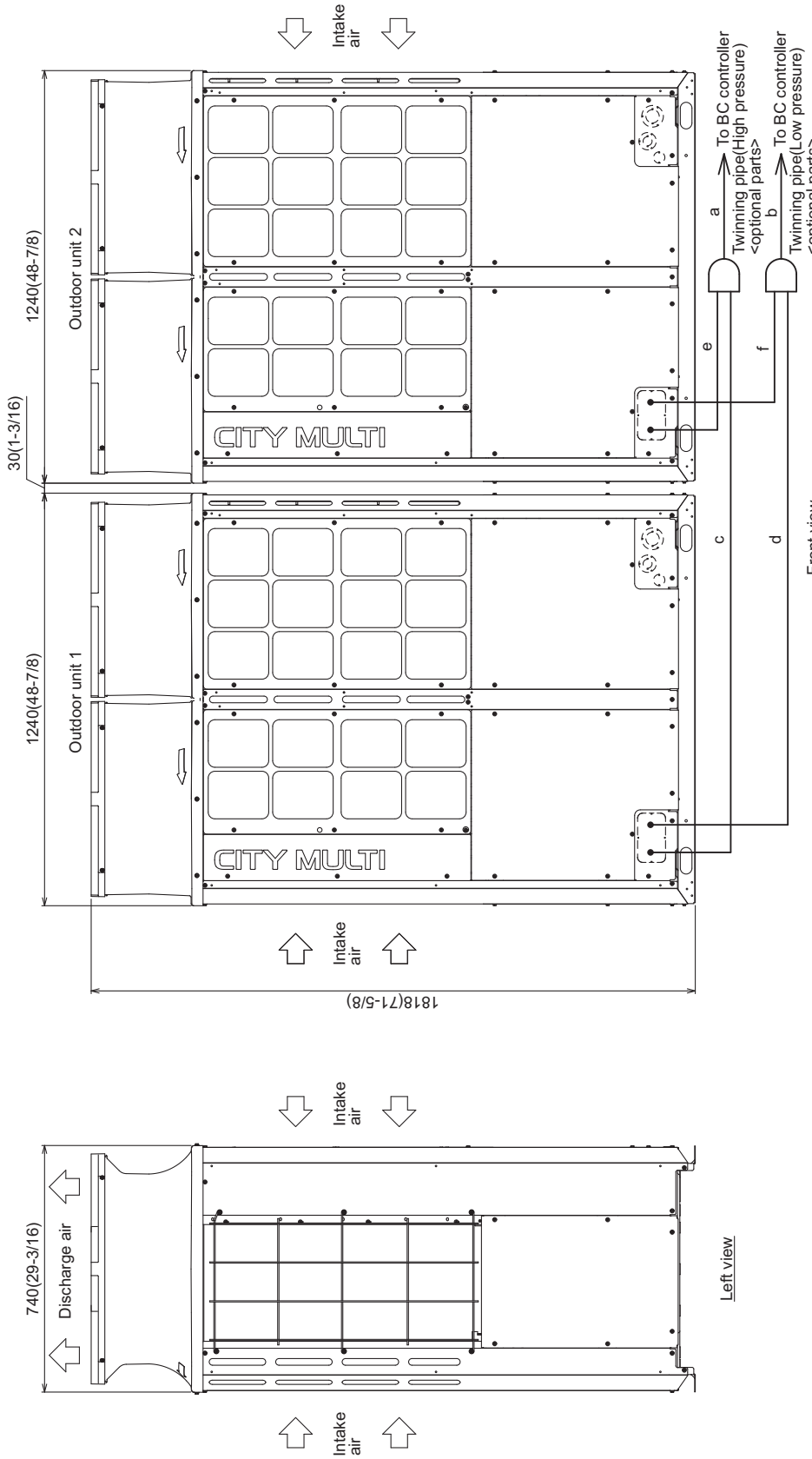

Fig.B

PURY-EP192, 216, 240, 264, 288TSNU-A(-BS)

Unit: mm(in)



Twinning pipe connection size

Package unit name	PURY-EP192TSNU-A(-BS)	PURY-EP216TSNU-A(-BS)	PURY-EP240TSNU-A(-BS)	PURY-EP264TSNU-A(-BS)	PURY-EP288TSNU-A(-BS)
Outdoor unit 1	PURY-EP96TNU-A(-BS)	PURY-EP120TNU-A(-BS)	PURY-EP144TNU-A(-BS)	PURY-EP168TNU-A(-BS)	PURY-EP192TNU-A(-BS)
Outdoor unit 2	PURY-EP96TNU-A(-BS)	PURY-EP120TNU-A(-BS)	PURY-EP144TNU-A(-BS)	PURY-EP168TNU-A(-BS)	PURY-EP192TNU-A(-BS)
Outdoor Twinning Kit(optional parts)	CMY-R200NCBK				
BC controller ~Twinning pipe	High pressure a	High pressure b	Low pressure a	Low pressure b	Low pressure d or f
	ø22.2(7/8)	ø22.2(7/8)	ø28.58(1-1/8)*	ø28.58(1-1/8)	ø28.58(1-1/8)
			ø34.93(1-3/8)		

Unit model	High pressure core	Low pressure d or f
EP96	ø19.05(3/4)	ø22.2(7/8)
EP120	ø19.05(3/4)	ø28.58(1-1/8)
EP144	ø22.2(7/8)	ø28.58(1-1/8)

* When the piping length is 65m(213ft) or longer, use the ø28.58(1-1/8) pipe for the part that exceeds 65m(213ft).

- Note
1. Connect the pipes as shown in the figure above. Refer to the table above for the pipe size.
 2. Twinning pipes should not be tilted more than 15 degrees from the horizontal plane. Be sure to see the Installation Manual for details of Twinning pipe installation.
 3. The pipe section before the Twinning pipe (section "a" and "b" in the figure) must have at least 500mm(19-11/16) of straight section (*including the straight pipe that is supplied with the Twinning pipe).
 4. Only use the Twinning pipe by Mitsubishi (optional parts).

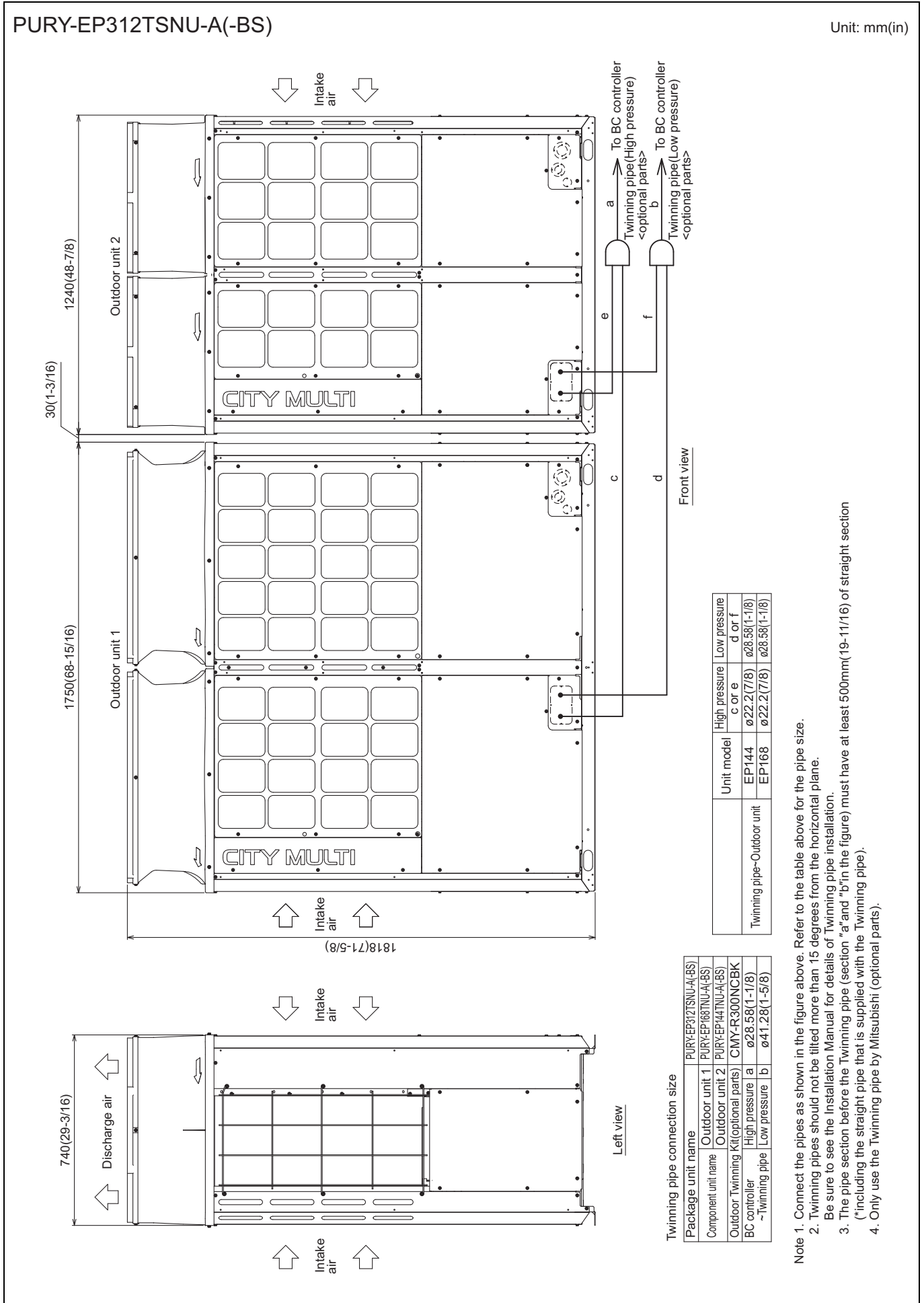

PURY-EP336TSNU-A(-BS)

Unit: mm(in)

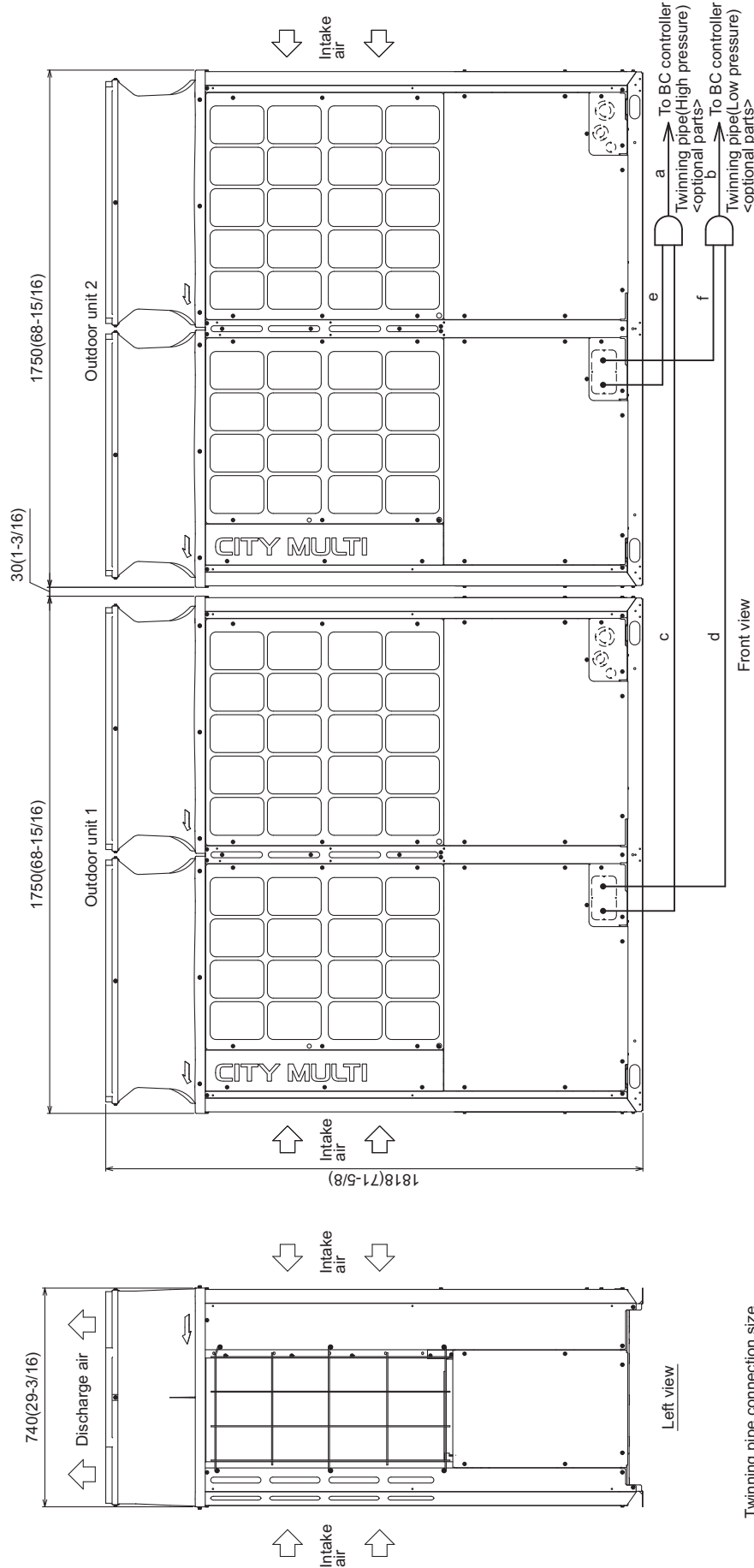

Front view

Left view

Twinning pipe connection size

Package unit name	PURY-EP336TSNU-A(-BS)
Component unit name	Outdoor unit 1 PURY-EP168TNU-A(-BS) Outdoor unit 2 PURY-EP168TNU-A(-BS)
Outdoor Twinning Kit (optional parts)	CMY-R300NCBK
BC controller	High pressure a ø28.58(1-1/8) Low pressure b ø41.28(1-5/8)

Unit model	High pressure c or e Low pressure d or f
Twinning pipe-Outdoor unit	EP168 ø22.2(7/8) ø28.58(1-1/8)

- Note 1. Connect the pipes as shown in the figure above. Refer to the table above for the pipe size.
 2. Twinning pipes should not be tilted more than 15 degrees from the horizontal plane.
 Be sure to see the Installation Manual for details of Twinning pipe installation.
 3. The pipe section before the Twinning pipe (section "a" and "b" in the figure) must have at least 500mm(19-11/16) of straight section (*including the straight pipe that is supplied with the Twinning pipe).
 4. Only use the Twinning pipe by Mitsubishi (optional parts).

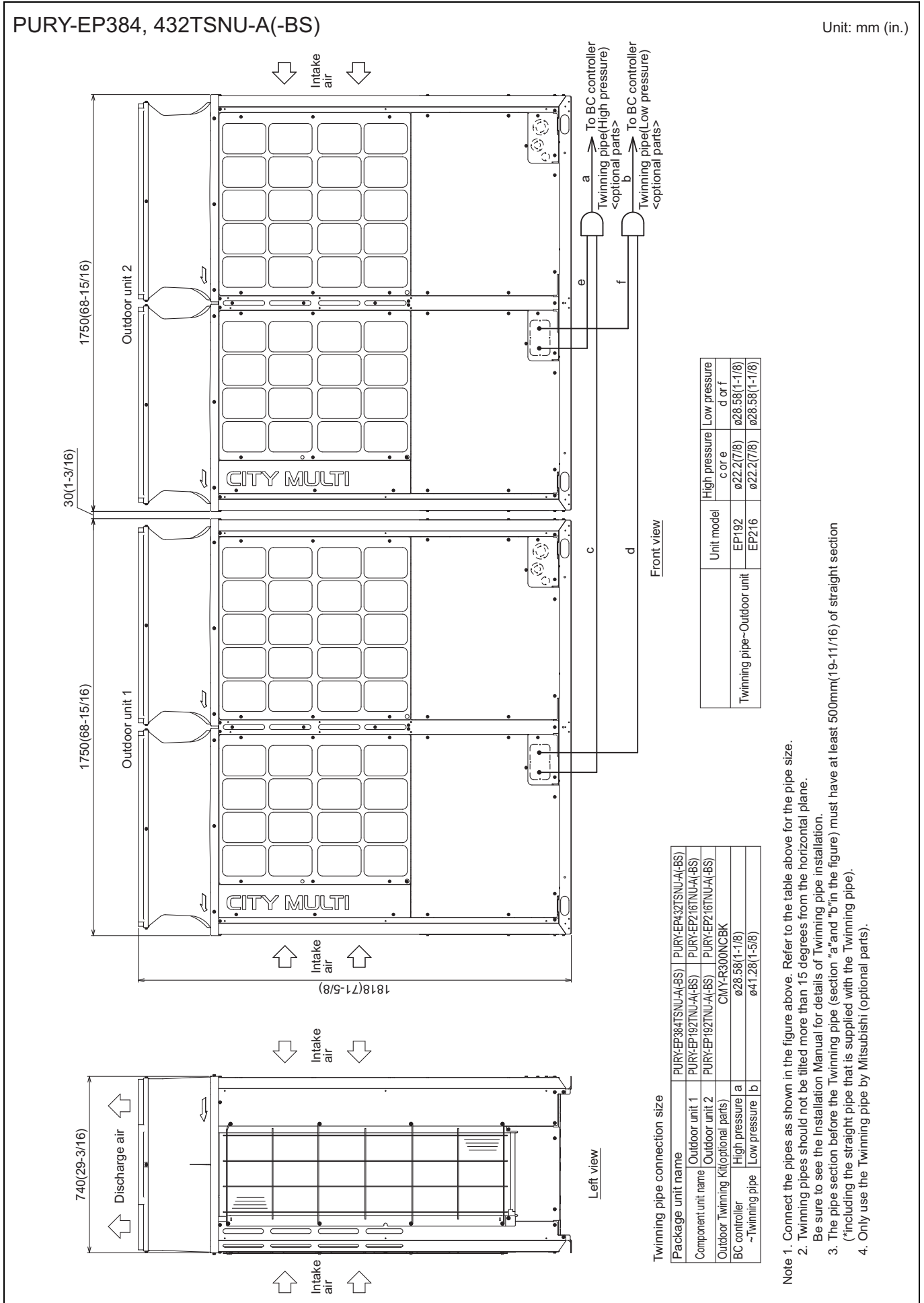

PURY-EP72YNU-A(-BS)

Unit: mm(in)

Note 1. Please refer to the next page for information regarding necessary spacing around the unit and foundation work.
 2. At brazing of pipes, wrap the refrigerant service valve with wet cloth and keep the temperature of refrigerant service valve under 120°C(248°F).

Connecting pipe specifications

Model	Refrigerant pipe		Service valve	
	High pressure	Low pressure	High pressure	Low pressure
EP72	φ15.88(5/8) Braze ^{*1}	φ19.05(3/4) Braze ^{*1}	φ22.2(7/8)	φ28.58(1-1/8)

*1 Connect the refrigerant pipe to the service valve according to the Installation Manual.

NO.	Usage	Specifications
①	Front through hole	148(5-7/8) × 84(3-5/16) Knockout hole
②	Bottom through hole	150(5-15/16) × 94(3-3/4) Knockout hole
③	Front through hole	φ62.7(2-1/2) or φ34.5(1-3/8) Knockout hole
④	Front through hole	φ43.7(1-3/4) or φ22.2(7/8) Knockout hole
⑤	Bottom through hole	φ65(2-9/16) Knockout hole
⑥	Bottom through hole	φ52(2-1/16) Knockout hole
⑦	Front through hole	φ34(1-3/8) Knockout hole
⑧	Bottom through hole	φ34(1-3/8) Knockout hole

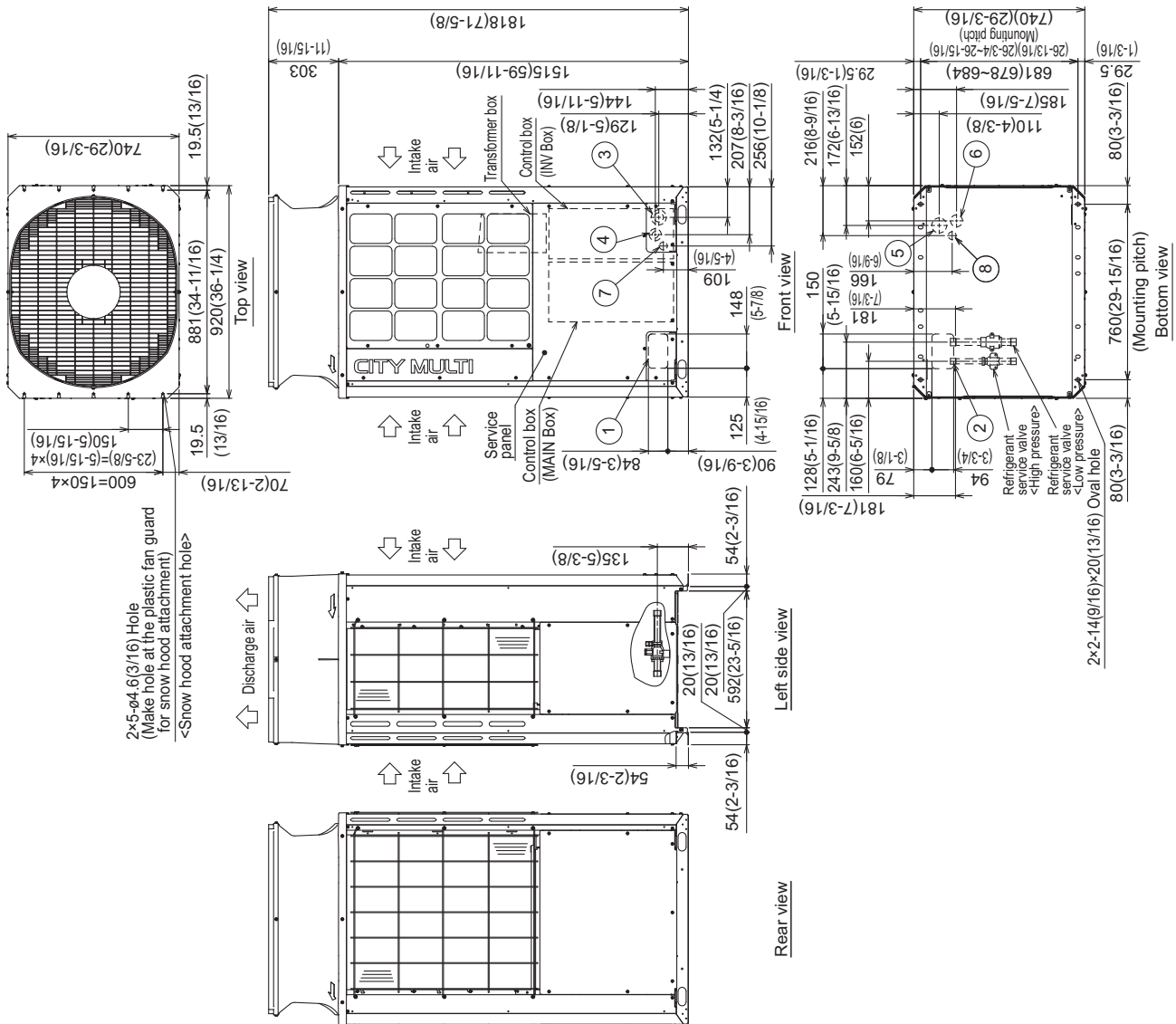

Unit: mm(in)

PURY-EP72YNU-A(-BS)

1. Required space around the unit

● In case of single installation

- Secure enough space around the unit as shown in the figure below.
 - With a space of at least 300mm(11-13/16) to the wall on the back of the unit
- When the height of the walls on the front, back or on the sides <h> exceeds the wall height limit as defined below add the height that exceeds the height limit <h> to the figures that are marked with an asterisk.

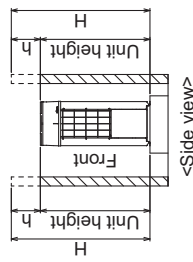
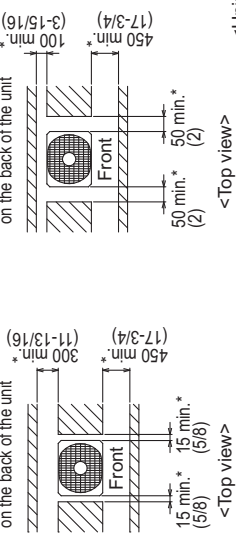

<Wall height limit> Front : Up to the unit height
Back : Up to the unit height
Side : Up to the unit height

2. Foundation work

- Take into consideration the surface strength, water drainage route, piping route, and wiring route when preparing the installation site.
 - Note that the drain water comes out of the unit during operation.>
- Build the foundation in such way that the corner of the installation leg is securely supported as shown in the right figure.(Fig.A)
When using a rubber isolating cushion, please ensure it is large enough to cover the entire width of each of the unit's legs.
- The protrusion length of the anchor bolt must not exceed 30mm(1-3/16).(Fig.A)
- Use four fixing plates as shown in the right figure <field supply required> when using M12 hole-in anchor bolts <field supply required> (Fig.B)
- To prevent small animals and water and snow from entering the unit and damaging its parts, close the gap around the edges of through holes for pipes and wires with filler plates <field supply required>.
- When the pipes or cables are routed at the bottom of the unit, make sure that the through hole at the base of the unit does not get blocked with the installation base.
- Refer to the Installation Manual when installing units on an installation base.

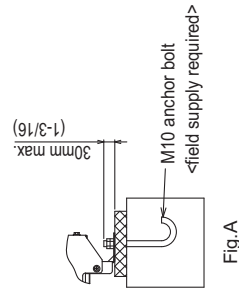

Fig.A

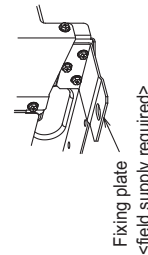
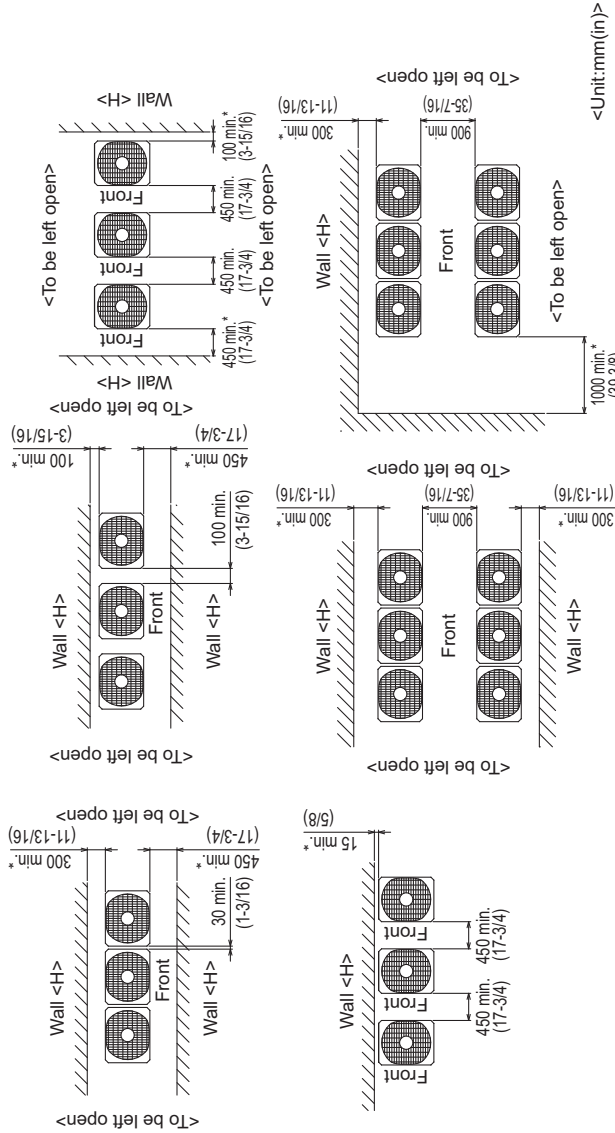

Fig.B

● In case of collective installation

- When multiple units are installed adjacent to each other, secure enough space to allow for air circulation and walkway between groups of units as shown in the figures below.
- At least two sides must be left open.
- As with the single installation, add the height that exceeds the height limit <h> to the figures that are marked with an asterisk.
- If there is a wall at both the front and the rear of the unit, install up to six units consecutively in the side direction and provide a space of 1000mm(39-3/8) or more as inlet space/ passage space for each six units.



PURY-EP96, 120, 144YNU-A(-BS)

Unit: mm(in)

Note 1. Please refer to the next page for information regarding necessary spacing around the unit and foundation work.
 2. At brazing of pipes, wrap the refrigerant service valve with wet cloth and keep the temperature of refrigerant service valve under 120°C(248°F).

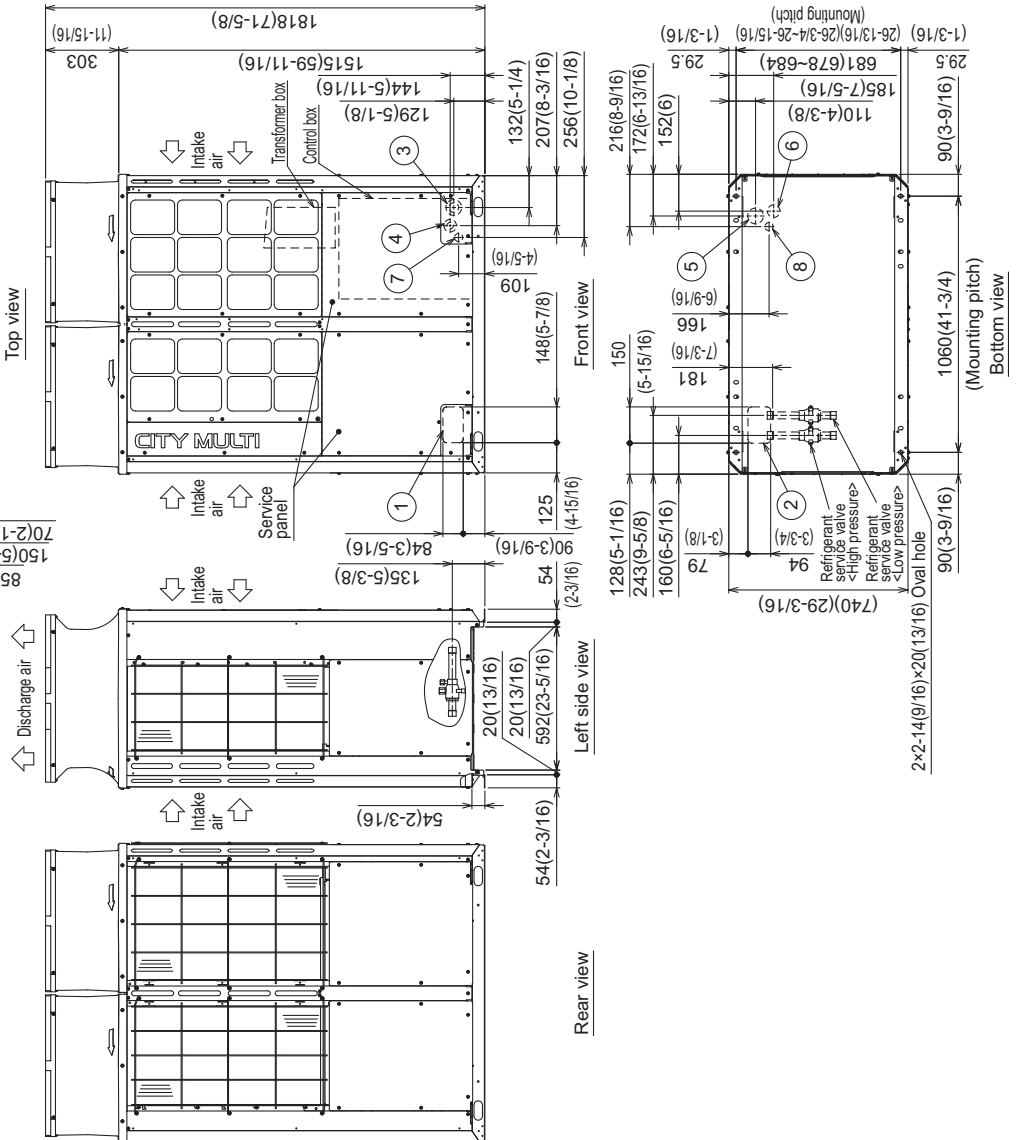

Connecting pipe specifications

Model	Refrigerant pipe		Service valve	
	High pressure	Low pressure	High pressure	Low pressure
EP96	φ19.05(3/4) Brazed*1	φ22.2(7/8) Brazed*1	φ28.58(1-1/8)	φ28.58(1-1/8)
EP120	φ19.05(3/4) Brazed*1	φ22.2(7/8) Brazed*1	φ28.58(1-1/8)	φ28.58(1-1/8)
EP144	φ22.2(7/8) Brazed*1	φ28.58(1-1/8) Brazed*1	φ28.58(1-1/8)	φ28.58(1-1/8)

*1 Connect the refrigerant pipe to the service valve according to the Installation Manual.

NO.	Usage	Specifications
①	For pipes	Front through hole 148(5-7/8) × 84(3-5/16) Knockout hole
②		Bottom through hole 150(5-15/16) × 94(3-3/4) Knockout hole
③	For wires	Front through hole φ27.2(1-1/2) or φ34.5(1-3/8) Knockout hole
④		Front through hole φ43.7(1-3/4) or φ22.2(7/8) Knockout hole
⑤		Bottom through hole φ65(2-9/16) Knockout hole
⑥		Bottom through hole φ52(2-1/16) Knockout hole
⑦	For transmission cables	Front through hole φ34(1-3/8) Knockout hole
⑧		Bottom through hole φ34(1-3/8) Knockout hole

Unit: mm(in)

PURY-EP96, 120, 144YNU-A(-BS)

1. Required space around the unit

● In case of single installation

- Secure enough space around the unit as shown in the figure below.
 - With a space of at least 300mm(11-13/16) to the wall on the back of the unit
 - With a space of at least 100mm(3-15/16) to the wall on the back of the unit

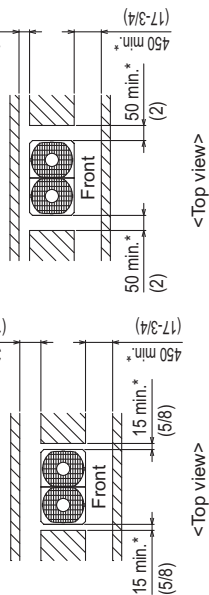

- When the height of the walls on the front, back or on the sides <h> exceeds the wall height limit as defined below add the height that exceeds the height limit <h> to the figures that are marked with an asterisk.

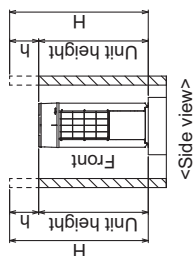

<Wall height limit> Front : Up to the unit height
Back : Up to the unit height
Side : Up to the unit height

2. Foundation work

- Take into consideration the surface strength, water drainage route, piping route, and wiring route when preparing the installation site.
 - Note that the drain water comes out of the unit during operation >
- Build the foundation in such way that the corner of the installation leg is securely supported as shown in the right figure.(Fig.A)
When using a rubber isolating cushion, please ensure it is large enough to cover the entire width of each of the unit's legs.
 - The protrusion length of the anchor bolt must not exceed 30mm(1-3/16).(Fig.A)
 - Use four fixing plates as shown in the right figure <field supply required> when using M12 hole-in anchor bolts <field supply required>.(Fig.B)
 - To prevent small animals and water and snow from entering the unit and damaging its parts, close the gap around the edges of through holes for pipes and wires with filler plates <field supply required>.
 - When the pipes or cables are routed at the bottom of the unit, make sure that the through hole at the base of the unit does not get blocked with the installation base.
 - Refer to the Installation Manual when installing units on an installation base.

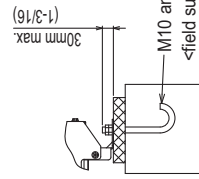

Fig.A

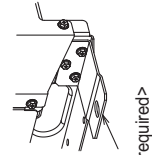
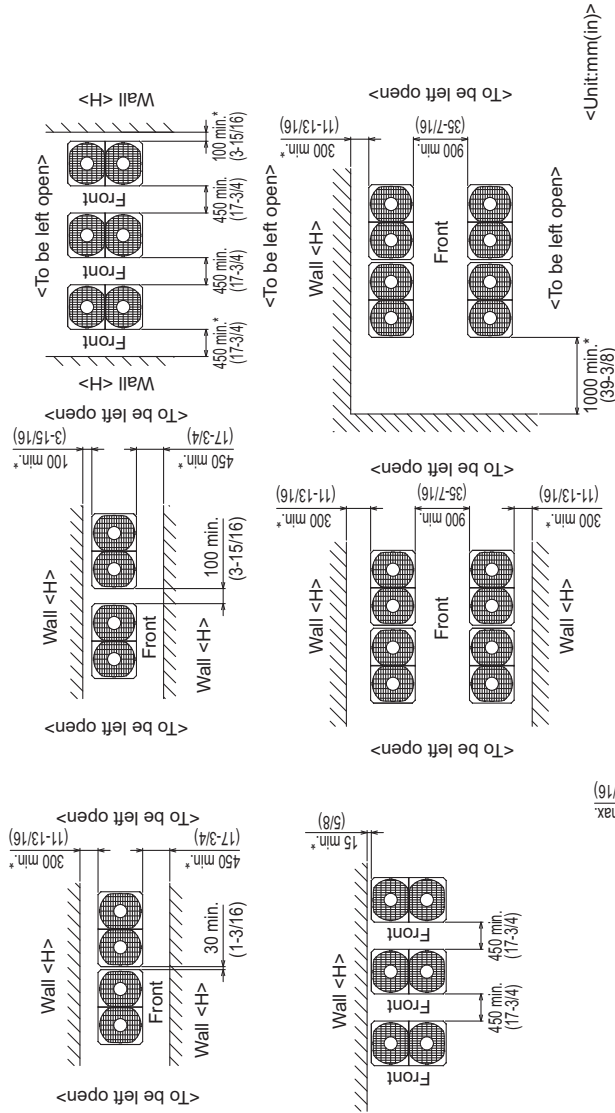

Fig.B

● In case of collective installation

- When multiple units are installed adjacent to each other, secure enough space to allow for air circulation and walkway between groups of units as shown in the figures below.
 - At least two sides must be left open.
 - As with the single installation, add the height that exceeds the height limit <h> to the figures that are marked with an asterisk.
 - If there is a wall at both the front and the rear of the unit, install up to six units consecutively in the side direction and provide a space of 1000mm(39-3/8) or more as inlet space/ passage space for each six units.



<Unit:mm(in)>

PURY-EP168YNU-A(-BS)

Unit: mm(in)

Note 1. Please refer to the next page for information regarding necessary spacing around the unit and foundation work.
 2. At brazing of pipes, wrap the refrigerant service valve with wet cloth and keep the temperature of refrigerant service valve under 120°C(248°F).

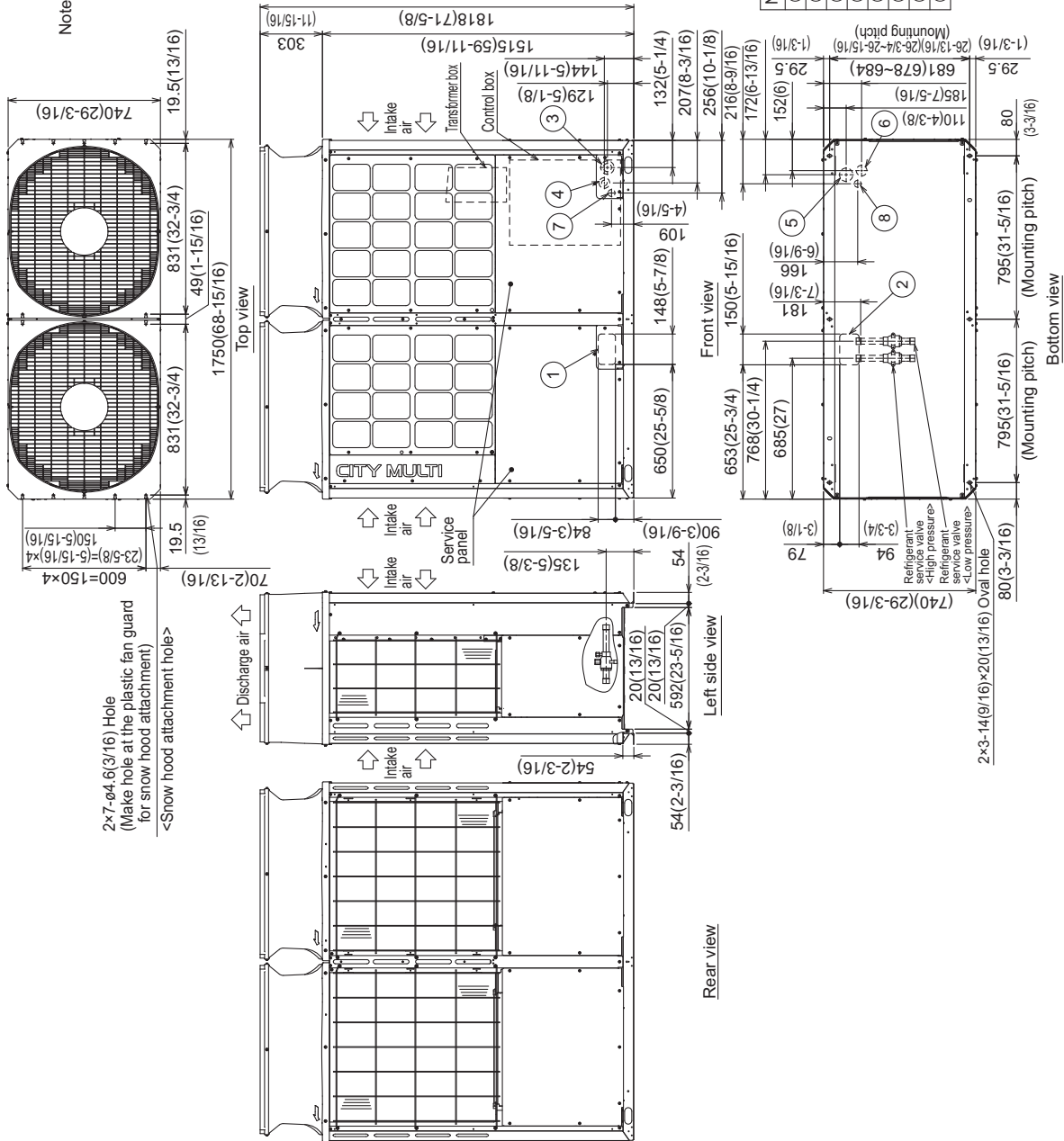

Connecting pipe specifications

Model	Refrigerant pipe		Service valve	
	High pressure	Low pressure	High pressure	Low pressure
EP168	ø22.7(8)	ø23.5(9)	1" Brazed	ø23.5(9)
			1" Brazed	ø23.5(9)

*1 Connect the refrigerant pipe to the service valve according to the Installation Manual.

NO.	Usage	Specifications
①	Front through hole	148(5-7/8) × 84(3-5/16) Knockout hole
②	Bottom through hole	150(5-15/16) × 94(3-3/4) Knockout hole
③	Front through hole	ø62.7(2-1/2) or ø34.5(1-3/8) Knockout hole
④	Front through hole	ø43.7(1-3/4) or ø22.2(7/8) Knockout hole
⑤	Bottom through hole	ø65(2-9/16) Knockout hole
⑥	Bottom through hole	ø52(2-1/16) Knockout hole
⑦	Front through hole	ø34(1-3/8) Knockout hole
⑧	Bottom through hole	ø34(1-3/8) Knockout hole

PURY-EP168YNU-A(-BS)

Unit: mm(in)

1. Required space around the unit

● In case of single installation

- ① Secure enough space around the unit as shown in the figure below.

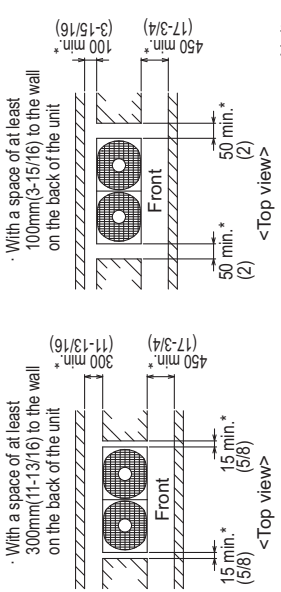

- ② When the height of the walls on the front, back or on the sides <h> exceeds the wall height limit as defined below add the height that exceeds the height limit <h> to the figures that are marked with an asterisk.

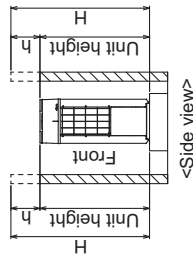

<Wall height limit> Front : Up to the unit height
Back : Up to the unit height
Side : Up to the unit height

2. Foundation work

- ① Take into consideration the surface strength, water drainage route, piping route, and wiring route when preparing the installation site.
<Note that the drain water comes out of the unit during operation.>
- ② Build the foundation in such way that the corner of the installation leg is securely supported as shown in the right figure.(Fig.A)
When using a rubber isolating cushion, please ensure it is large enough to cover the entire width of each of the unit's legs.
- ③ The protrusion length of the anchor bolt must not exceed 30mm(1-3/16).(Fig.A)
- ④ Use six fixing plates as shown in the right figure <field supply required> when using M12 hole-in anchor bolts <field supply required> (Fig.B)
- ⑤ To prevent small animals and water and snow from entering the unit and damaging its parts, close the gap around the edges of through holes for pipes and wires with filler plates <field supply required>.
- ⑥ When the pipes or cables are routed at the bottom of the unit, make sure that the through hole at the base of the unit does not get blocked with the installation base.
- ⑦ Refer to the Installation Manual when installing units on an installation base.

● In case of collective installation

- ① When multiple units are installed adjacent to each other, secure enough space to allow for air circulation and walkway between groups of units as shown in the figures below.
- ② At least two sides must be left open.
- ③ As with the single installation, add the height that exceeds the height limit <h> to the figures that are marked with an asterisk.
- ④ If there is a wall at both the front and the rear of the unit, install up to three units consecutively in the side direction and provide a space of 1000mm(39-3/8) or more as inlet space/ passage space for each three units.

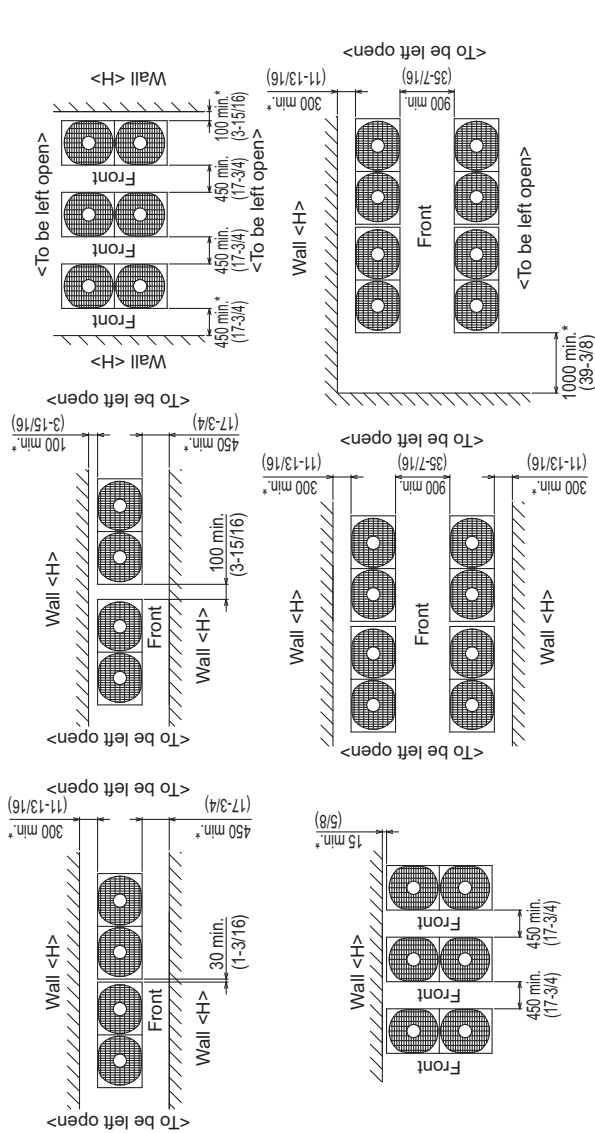

<Unit: mm(in)>

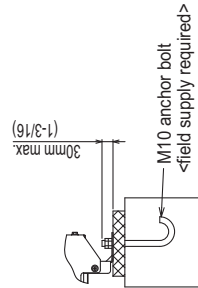

Fig.A

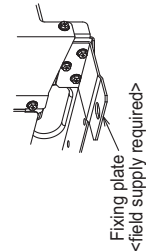
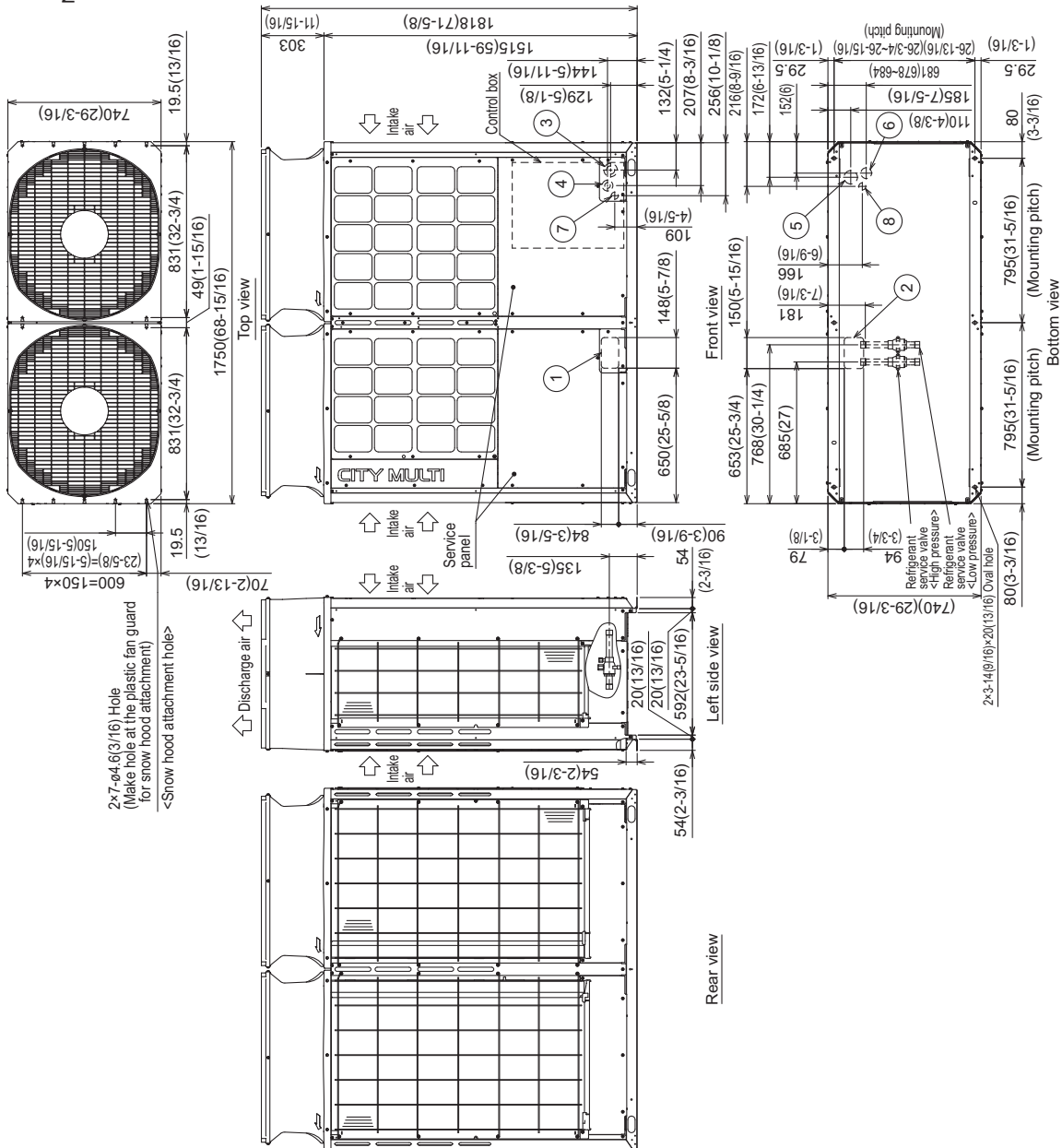

Fig.B

PURY-EP192, 216, 240YNU-A(-BS)

Unit: mm (in.)

Note 1. Please refer to the next page for information regarding necessary spacing around the unit and foundation work.
 2. At brazing of pipes, wrap the refrigerant service valve with wet cloth and keep the temperature of refrigerant service valve under 120°C(248°F).



Connecting pipe specifications

Model	Refrigerant pipe		Service valve	
	High pressure	Low pressure	High pressure	Low pressure
EP192	ø22.2(7/8) Brazed *1	ø28.58(1-1/8) Brazed	ø28.58(1-1/8)	ø28.58(1-1/8)
EP216	ø22.2(7/8) Brazed *1,2	ø34.93(1-3/8) Brazed *1	ø28.58(1-1/8)	ø28.58(1-1/8)
EP240	ø22.2(7/8) Brazed *1,2	ø34.93(1-3/8) Brazed *1	ø28.58(1-1/8)	ø28.58(1-1/8)

*1 Connect the refrigerant pipe to the service valve according to the Installation Manual.
 *2 When the piping length is 65m(213ft) or longer, use the ø28.58(1-1/8) pipe for the part that exceeds 65m(213ft).

NO.	Usage	Specifications
①	Front through hole	148(6-7/8) × 84(3-5/16) Knockout hole
②	Bottom through hole	150(6-15/16) × 94(3-3/4) Knockout hole
③	Front through hole	ø62.7(2-1/2) or ø34.5(1-3/8) Knockout hole
④	Front through hole	ø43.7(1-3/4) or ø22.2(7/8) Knockout hole
⑤	Bottom through hole	ø65(2-9/16) Knockout hole
⑥	Bottom through hole	ø52(2-1/16) Knockout hole
⑦	Front through hole	ø34(1-3/8) Knockout hole
⑧	Bottom through hole	ø34(1-3/8) Knockout hole

PURY-EP192, 216, 240YNU-A(-BS)

Unit: mm (in.)

1. Required space around the unit

● In case of single installation

- ① Secure enough space around the unit as shown in the figure below.
 - With a space of at least 300mm(11-13/16) to the wall on the back of the unit

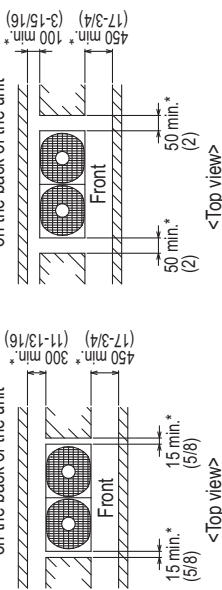

- ② When the height of the walls on the front, back or on the sides <H> exceeds the wall height limit as defined below add the height that exceeds the height limit <h> to the figures that are marked with an asterisk.

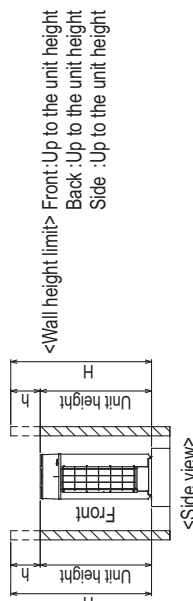

2. Foundation work

- ① Take into consideration the surface strength, water drainage route, piping route, and wiring route when preparing the installation site.
 - Note that the drain water comes out of the unit during operation.
- ② Build the foundation in such way that the corner of the installation leg is securely supported as shown in the right figure (Fig.A)
 - When using a rubber isolating cushion, please ensure it is large enough to cover the entire width of each of the unit's legs.
- ③ The protrusion length of the anchor bolt must not exceed 30mm(1-3/16) (Fig.A)
- ④ Use six fixing plates as shown in the right figure <field supply required> when using M12 hole-in anchor bolts <field supply required> (Fig.B)
- ⑤ To prevent small animals and water and snow from entering the unit and damaging its parts, close the gap around the edges of through holes for pipes and wires with filler plates <field supply required>.
- ⑥ When the pipes or cables are routed at the bottom of the unit, make sure that the through hole at the base of the unit does not get blocked with the installation base.
- ⑦ Refer to the Installation Manual when installing units on an installation base.

● In case of collective installation

- ① When multiple units are installed adjacent to each other, secure enough space to allow for air circulation and walkway between groups of units as shown in the figures below.
- ② At least two sides must be left open.
- ③ As with the single installation, add the height that exceeds the height limit <h> to the figures that are marked with an asterisk.
- ④ If there is a wall at both the front and the rear of the unit, install up to three units consecutively in the side direction and provide a space of 1000mm(39-3/8) or more as inlet space/ passage space for each three units.

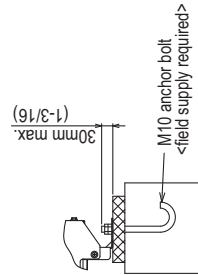
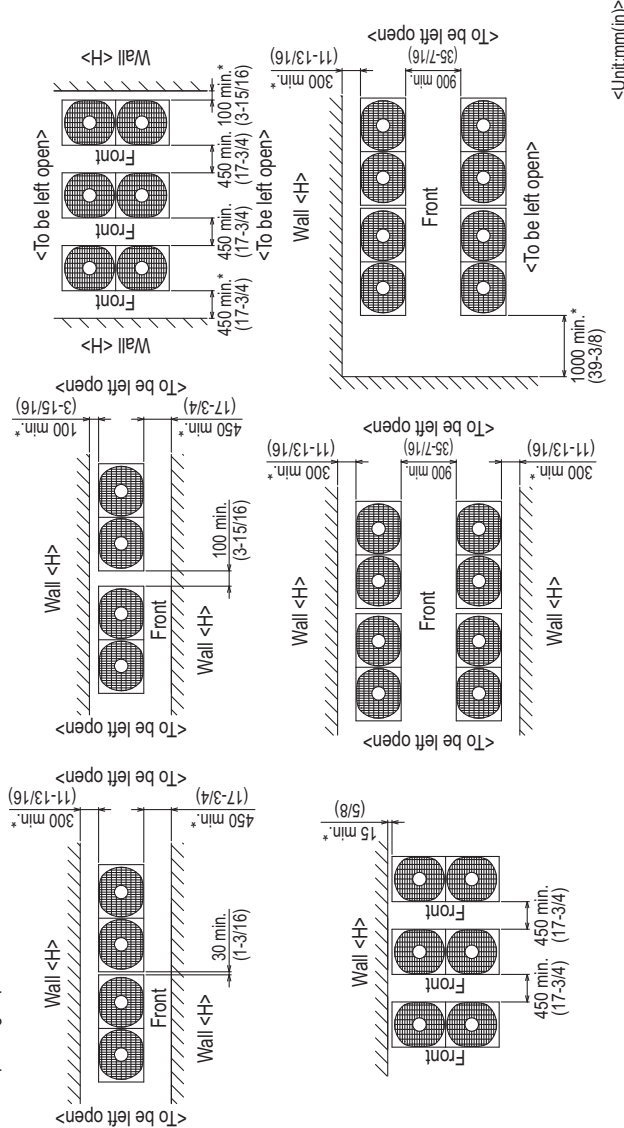

Fig.A

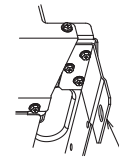
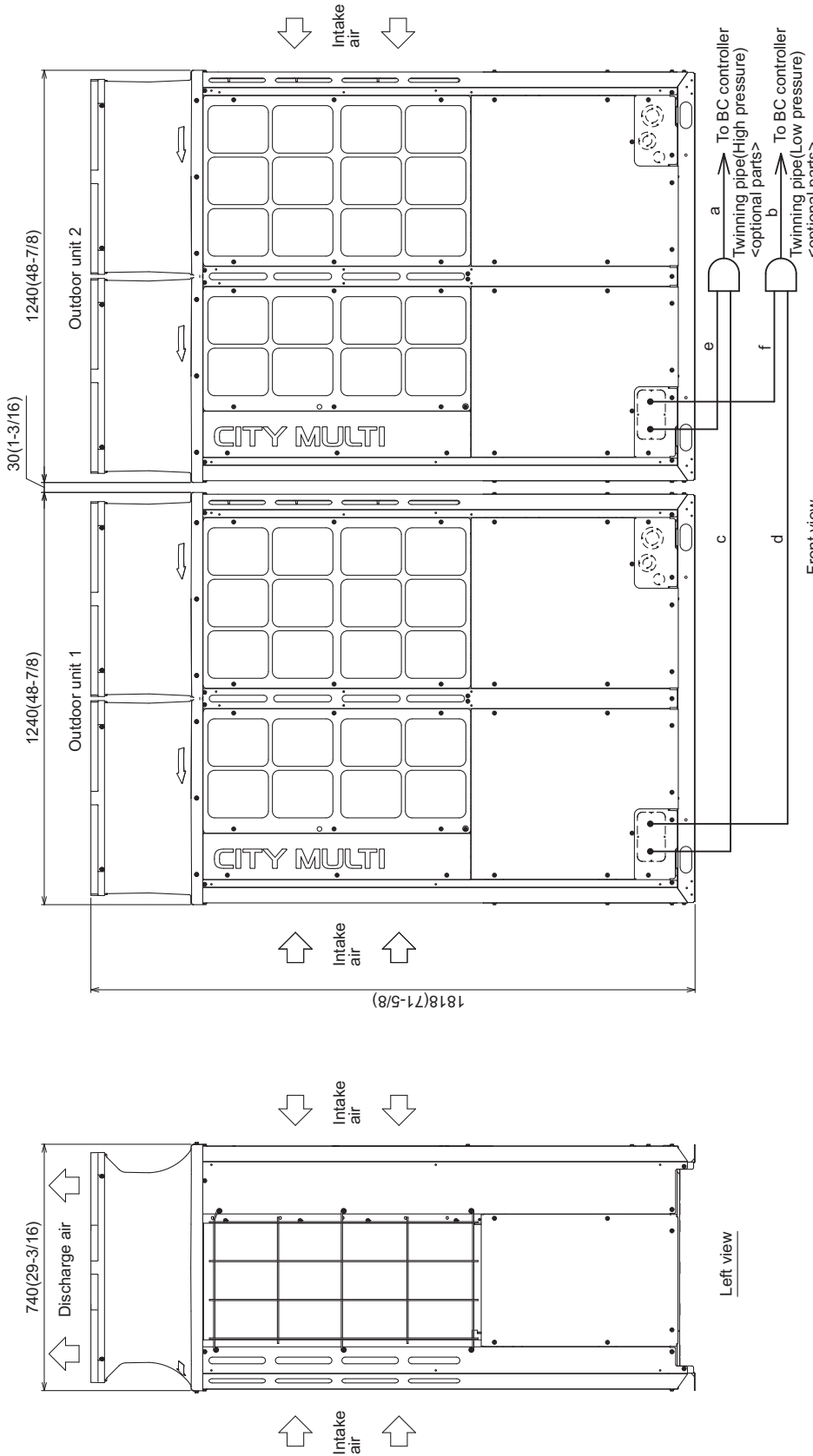

Fig.B

PURY-EP192, 216, 240, 264, 288YSNU-A(-BS)

Unit: mm(in)



Twinning pipe connection size

Package unit name	PURY-EP192YSNU-A(-BS)	PURY-EP216YSNU-A(-BS)	PURY-EP240YSNU-A(-BS)	PURY-EP264YSNU-A(-BS)	PURY-EP288YSNU-A(-BS)
Outdoor unit 1	PURY-EP098YNU-A(-BS)	PURY-EP120YNU-A(-BS)	PURY-EP144YNU-A(-BS)	PURY-EP168YNU-A(-BS)	PURY-EP192YNU-A(-BS)
Outdoor unit 2	PURY-EP098YNU-A(-BS)	PURY-EP098YNU-A(-BS)	PURY-EP120YNU-A(-BS)	PURY-EP144YNU-A(-BS)	PURY-EP168YNU-A(-BS)
Outdoor Twinning Kit (optional parts)	CMY-R2000NCBK				
BC controller	CMY-R3000NCBK				
~Twinning pipe	High pressure a	High pressure c	High pressure e	Low pressure b	Low pressure d or f
	ø22.2(7/8)	ø22.2(7/8)	ø22.2(7/8)	ø28.58(1-1/8)	ø28.58(1-1/8)
				ø34.93(1-3/8)	

* When the piping length is 65m(213ft) or longer, use the ø28.58(1-1/8) pipe for the part that exceeds 65m(213ft).

1. Connect the pipes as shown in the figure above. Refer to the table above for the pipe size.
2. Twinning pipes should not be tilted more than 15 degrees from the horizontal plane. Be sure to see the Installation Manual for details of Twinning pipe installation.
3. The pipe section before the Twinning pipe (section "a" and "b" in the figure) must have at least 500mm(19-11/16) of straight section (*including the straight pipe that is supplied with the Twinning pipe).
4. Only use the Twinning pipe by Mitsubishi (optional parts).

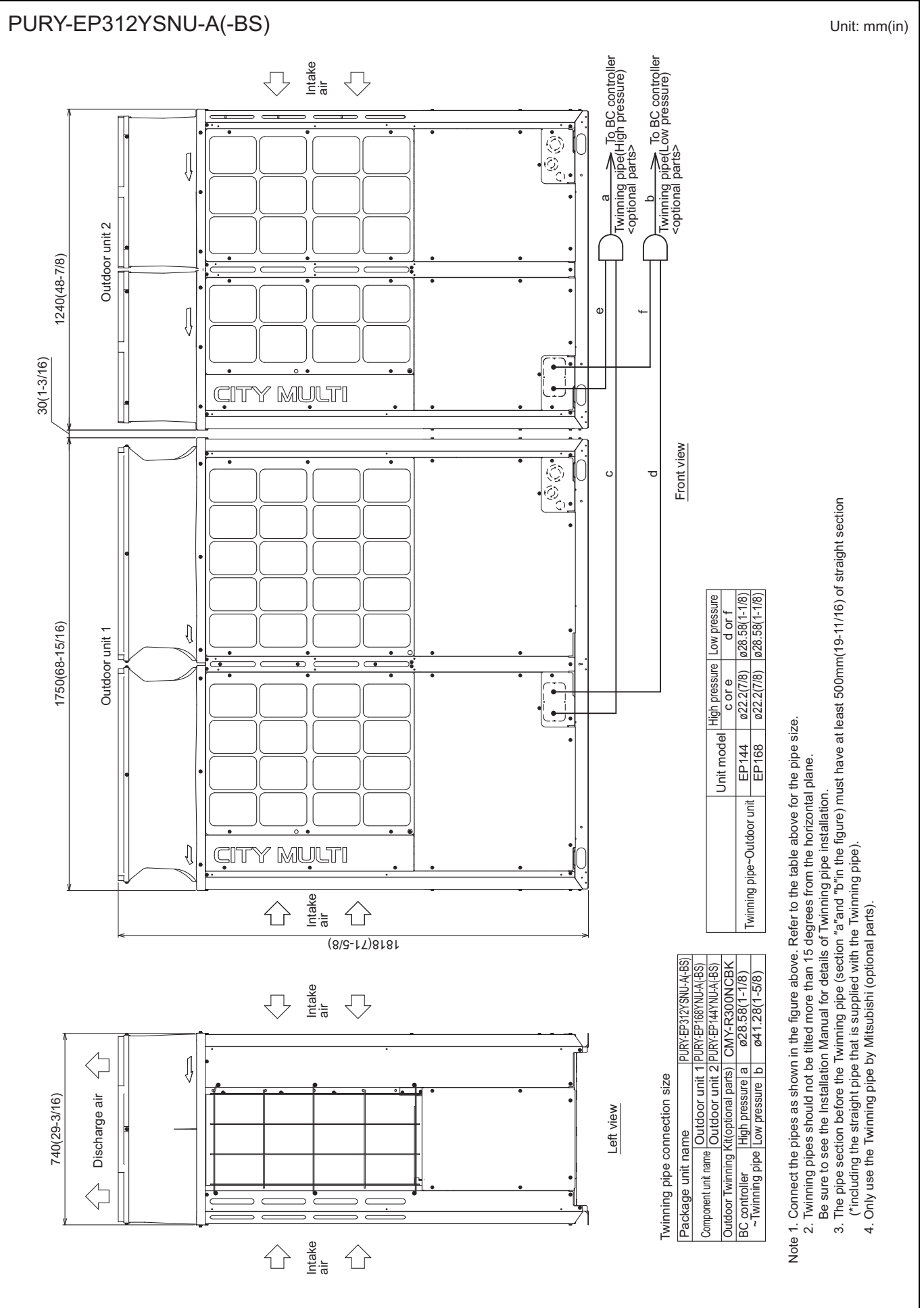

PURY-EP336YSNU-A(-BS)

Unit: mm(in)

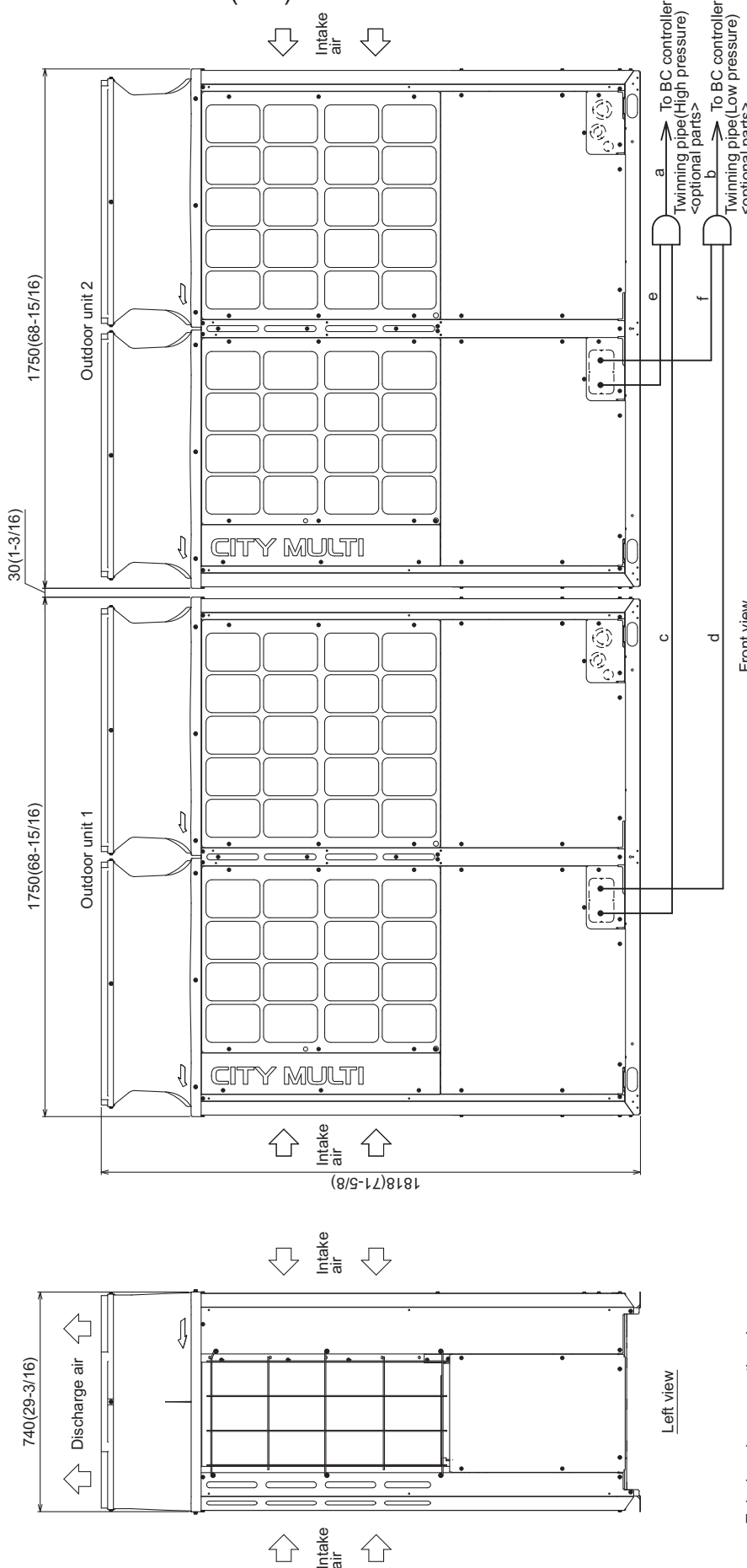

Front view

Left view

Unit model	High pressure	Low pressure
EP168	c or e ø22.2(7/8)	d or f ø28.58(1-1/8)

Twinning pipe connection size

Package unit name	PURY-EP336YSNU-A(-BS)
Outdoor unit 1	PURY-EP168YSNU-A(-BS)
Outdoor unit 2	PURY-EP168YSNU-A(-BS)
Outdoor Twinning Kit(optional parts)	CMY-R300NCBK
BC controller	High pressure a ø28.58(1-1/8)
~Twinning pipe	Low pressure b ø41.28(1-5/8)

- Note 1. Connect the pipes as shown in the figure above. Refer to the table above for the pipe size.
 2. Twinning pipes should not be tilted more than 15 degrees from the horizontal plane.
 Be sure to see the Installation Manual for details of Twinning pipe installation.
 3. The pipe section before the Twinning pipe (section "a" and "b" in the figure) must have at least 500mm(19-11/16) of straight section
 (*including the straight pipe that is supplied with the Twinning pipe).
 4. Only use the Twinning pipe by Mitsubishi (optional parts).

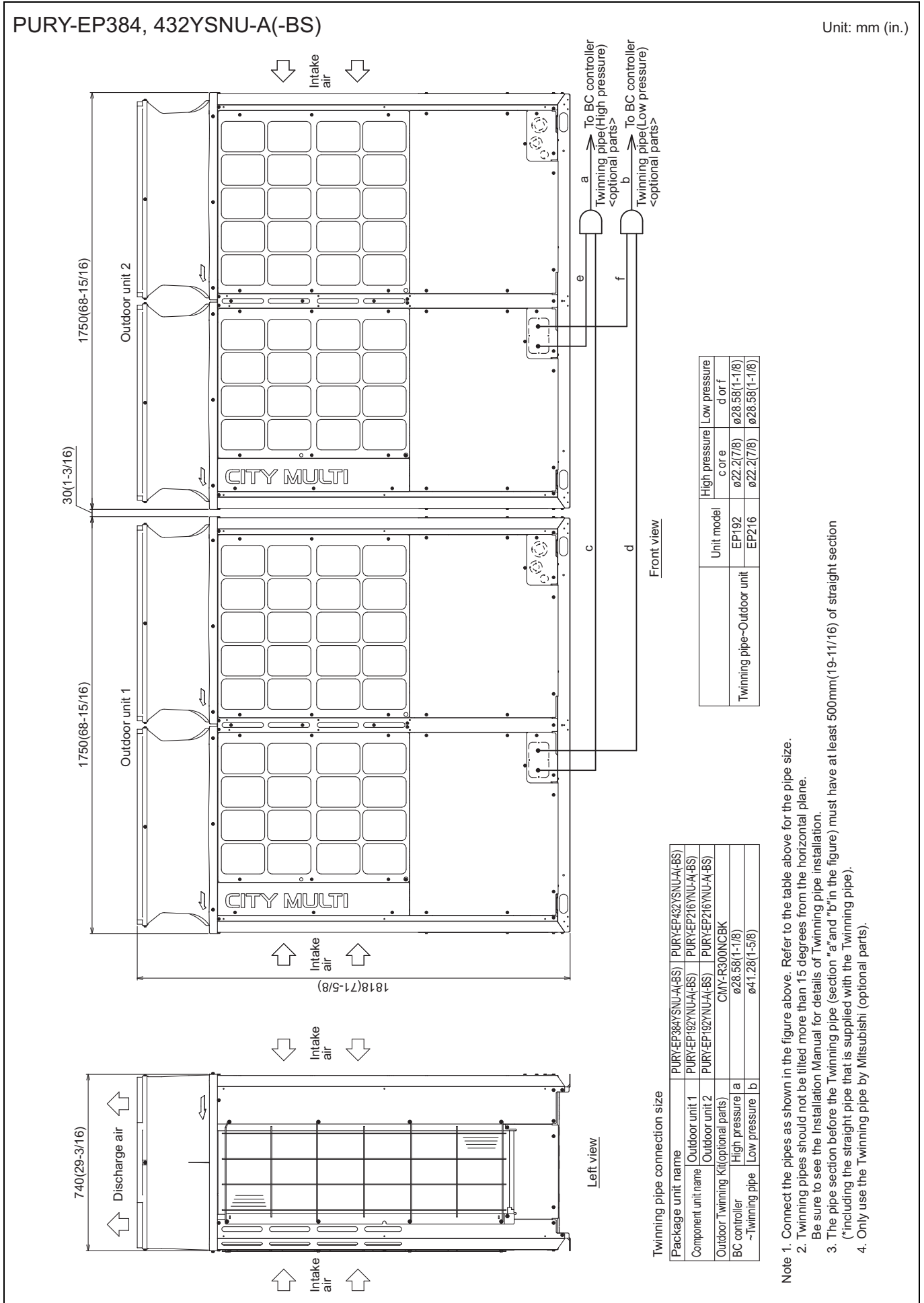

PURY-EP-T(S)NU-A, Y(S)NU-A

PURY-EP72TNU-A (-BS)
PURY-EP72YNU-A (-BS)

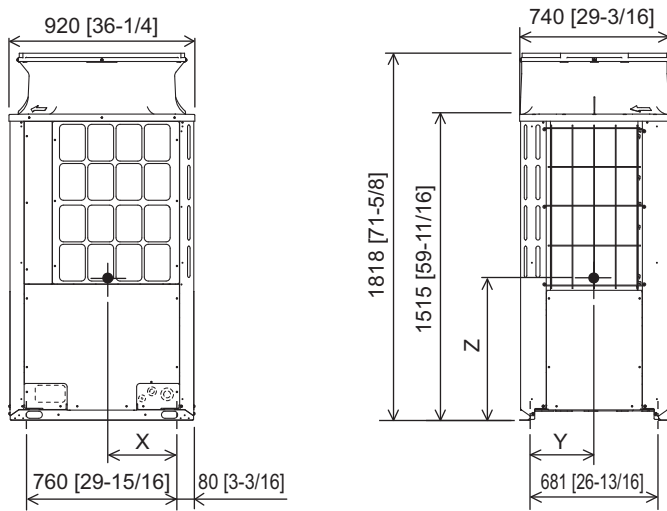

Unit: mm [in.]

Model	X	Y	Z
PURY-EP72TNU-A(-BS)	355 [14]	347 [13-11/16]	709 [27-15/16]
PURY-EP72YNU-A(-BS)	343 [13-9/16]	337 [13-5/16]	709 [27-15/16]

PURY-EP96, 120, 144TNU-A (-BS)
PURY-EP96, 120, 144YNU-A (-BS)

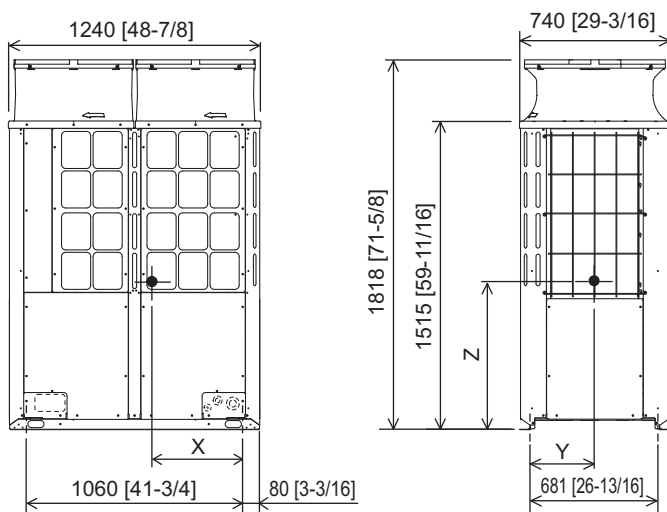

Unit: mm [in.]

Model	X	Y	Z
PURY-EP96TNU-A(-BS)	499 [19-11/16]	346 [13-5/8]	696 [27-1/16]
PURY-EP120TNU-A(-BS)	500 [19-11/16]	347 [13-11/16]	691 [27-1/4]
PURY-EP144TNU-A(-BS)	503 [19-13/16]	349 [13-3/4]	714 [28-1/8]
PURY-EP96YNU-A(-BS)	480 [18-15/16]	335 [13-1/4]	693 [27-5/16]
PURY-EP120YNU-A(-BS)	481 [18-15/16]	336 [13-1/4]	688 [27-1/8]
PURY-EP144YNU-A(-BS)	484 [19-1/16]	338 [13-5/16]	711 [28]

PURY-EP168TNU-A (-BS)
PURY-EP168YNU-A (-BS)

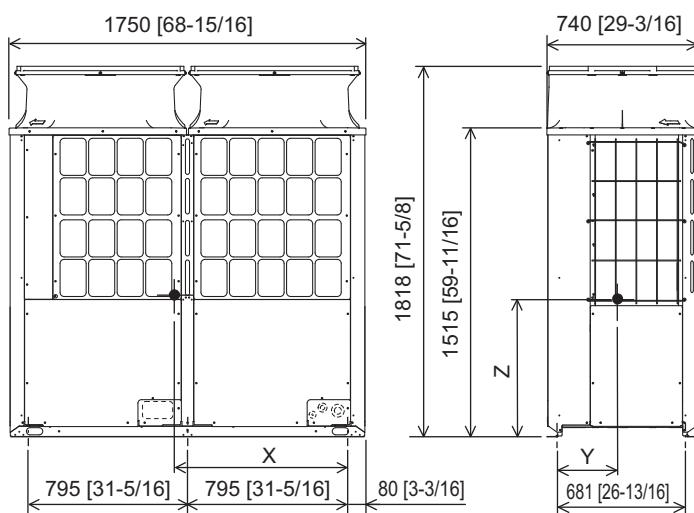

Unit: mm [in.]

Model	X	Y	Z
PURY-EP168TNU-A(-BS)	866 [34-1/8]	322 [12-11/16]	774 [30-1/2]
PURY-EP168YNU-A(-BS)	839 [33-1/16]	315 [12-7/16]	771 [30-3/8]

PURY-EP192, 216, 240TNU-A (-BS)
 PURY-EP192, 216, 240YNU-A (-BS)

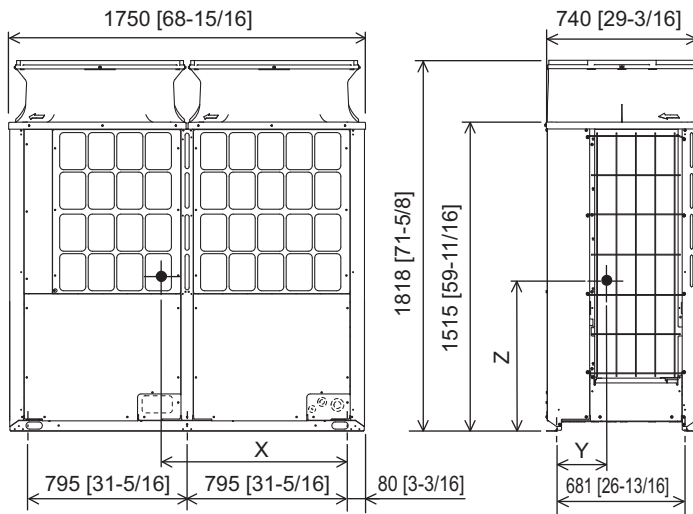

Unit: mm [in.]

Model	X	Y	Z
PURY-EP192TNU-A(-BS)	914 [36]	314 [12-6/16]	701 [27-5/8]
PURY-EP216TNU-A(-BS)	914 [36]	314 [12-6/16]	701 [27-5/8]
PURY-EP240TNU-A(-BS)	914 [36]	314 [12-6/16]	701 [27-5/8]
PURY-EP192YNU-A(-BS)	887 [34-15/16]	309 [12-3/16]	702 [27-11/16]
PURY-EP216YNU-A(-BS)	887 [34-15/16]	309 [12-3/16]	702 [27-11/16]
PURY-EP240YNU-A(-BS)	887 [34-15/16]	309 [12-3/16]	702 [27-11/16]

PURY-EP72TNU-A(-BS)

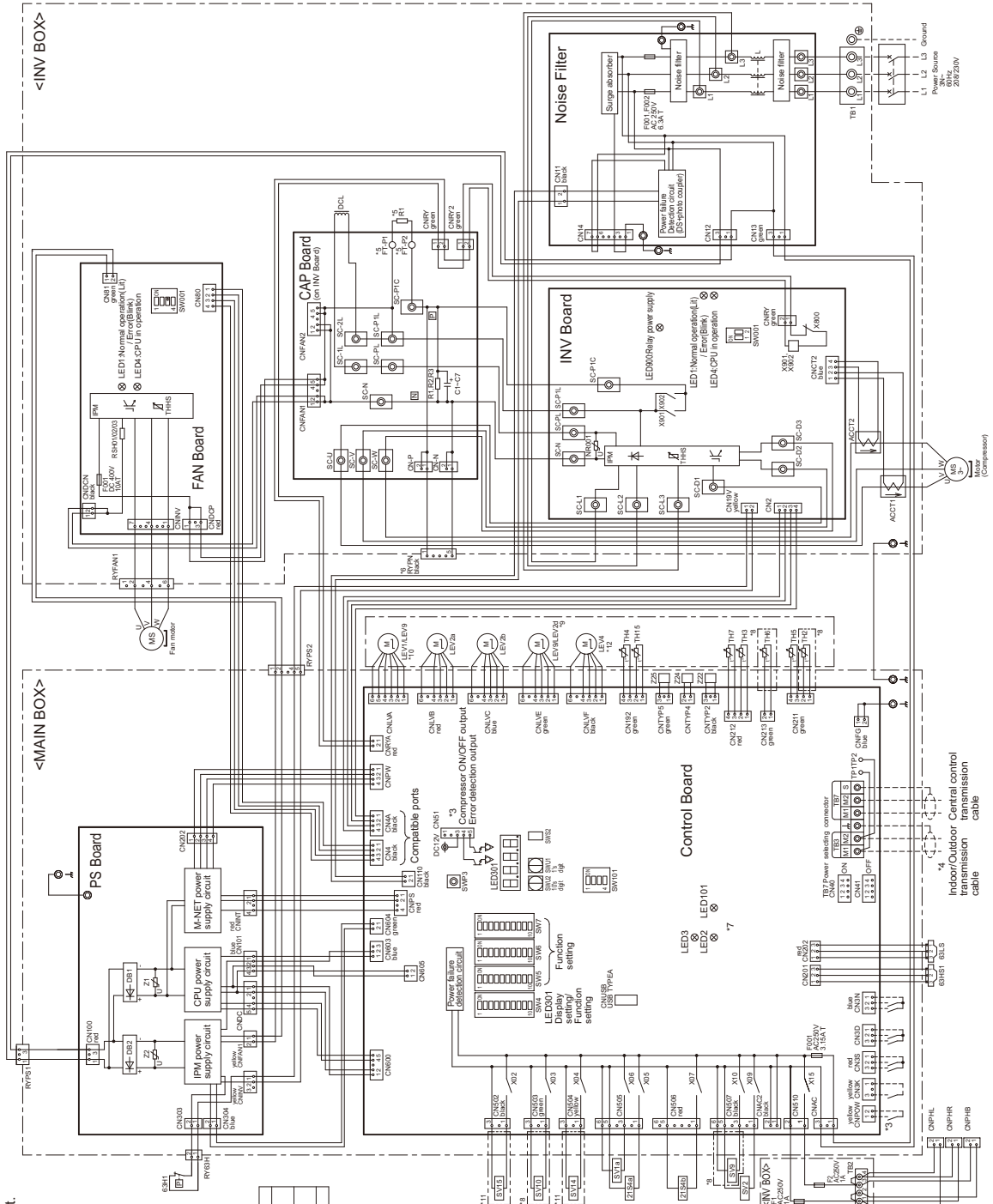

- *1. Single-dotted lines indicate wiring not supplied with the unit.
- *2. Dot-dash lines indicate the control box boundaries.
- *3. Refer to the Data book for connecting input/output signal connectors.
- *4. Daisy-chain terminals (TB3) on the outdoor units in the same refrigerant system together.
- *5. Faston terminals have a locking function. Make sure the terminals are securely locked in place after insertion. Press the tab on the terminals to removed them.
- *6. Control box houses high-voltage parts. Before inspecting the inside of the control box, turn off the power, keep the unit off for at least 10 minutes, and confirm that the voltage of the connector RYPN has dropped to DC20V or less.
- *7. Control board LED display.

LED2	Normal operation(L)/Error(Blink)
LED3	SW6-10 is OFF and in operation(L)/In stop(Unit)
LED4	SW6-10 is ON
LED101	Normal operation(L)/V/C Error(Unit)

*8. Difference of appliance.

Model name	Appliance
PURY, TURV	'9 exist
PURY, TURV	'10 exist
PURY, TURV	'11 exist

*10. Difference of appliance.

Model name	Appliance
PURY, TURV	LEV1
PURY, TURV	LEV9
PURY, TURV	LEV24

*11. Difference of appliance.

Model name	Appliance
PURY, PURY, TURV, TURV	'11 do not exist
PURY, EP, TURV	'11 exist

<Symbol explanation>

Symbol	Explanation
Z1S4b	Cooling/Heating switching
Z1S4b	4-way valve
63H1	Pressure switch
63HS1	Pressure sensor
63LS	Low pressure sensor
ACC1/ACC12	Capacitor (inverter main circuit)
C1-C7	Capacitor
DDL	Choke coil (for high frequency noise reduction)
LEV1 *10	Linear expansion valve
LEV24b	Valve
LEV24 *9	Valve
LEV4 *12	Valve
LEV9 *9,10	Valve
R1	Resistor
RSHT01/02/03	Solenoid valve
SV1a	Solenoid valve
SV2	Valve
SV9 *9	Valve
SV10 *8	Valve
SV14,15 *11	Valve
TB1	Terminal block
TB2	Terminal block
TB3	Terminal block
TB7	Terminal block
TH2 *8	Thermistor
TH3	Thermistor
TH4	Thermistor
TH5	Thermistor
TH6 *8	Thermistor
TH7	Thermistor
TH8	Thermistor
TH9	Thermistor
TH10	Thermistor
TH15	Thermistor
X301, X302	Magnetic relay (inverter main circuit)
Z22,24,25	Function setting connector

*12. Difference of appliance.

Model name	Appliance
PURY, EP, PURY, EP, TURV, TURV	'12 exist
PURY, PURY, TURV, TURV	'12 do not exist

PURY-EP96, 120, 144TNU-A(-BS)

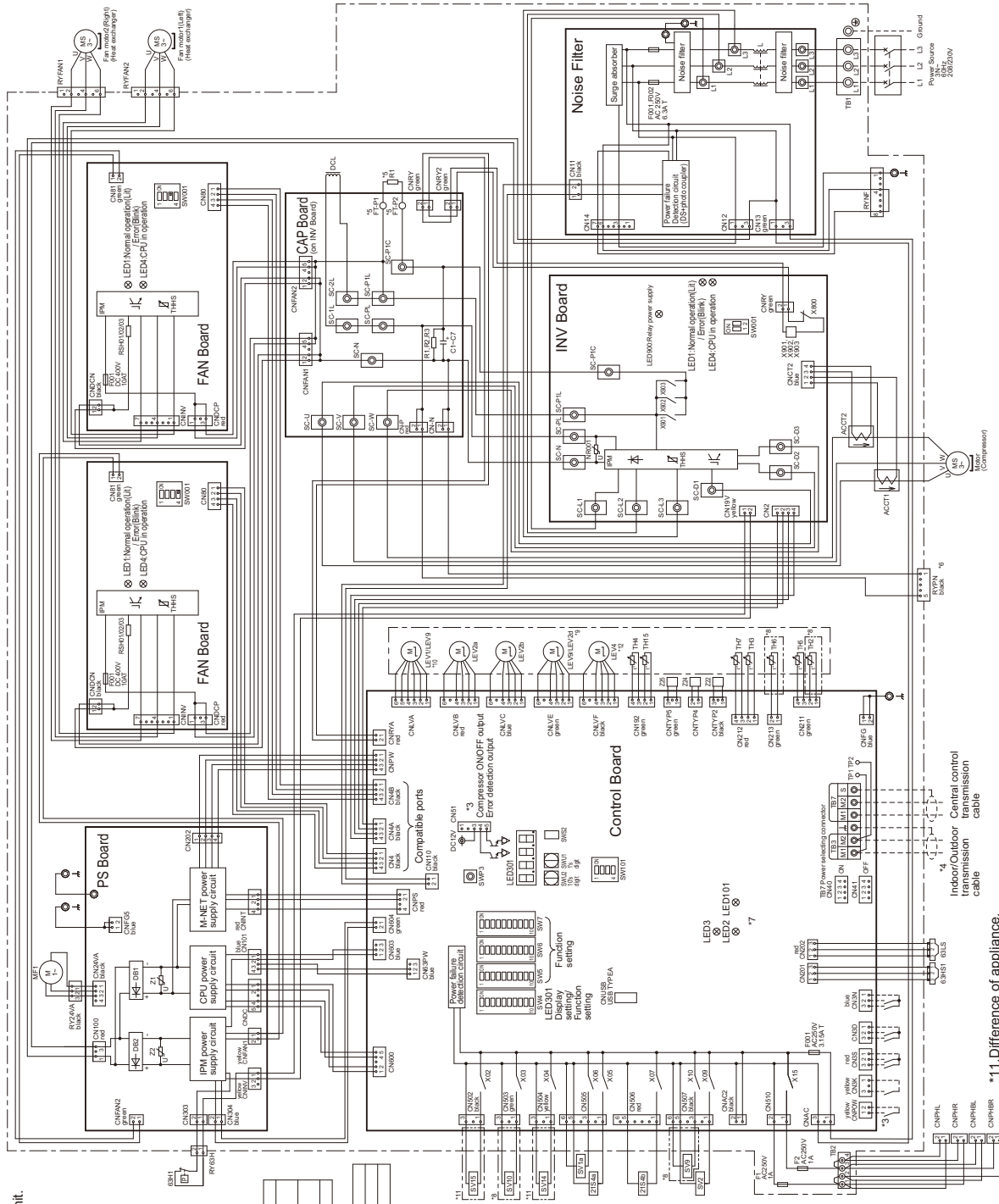

- *1. Single-dotted lines indicate wiring not supplied with the unit.
- *2. Dot-dash lines indicate the control box boundaries.
- *3. Refer to the Data book for connecting input/output signal connectors.
- *4. Daisy-chain terminals (TB3) on the outdoor units in the same refrigerant system together.
- *5. Faston terminals have a locking function. Make sure the terminals are securely locked in place after insertion. Press the tab on the terminals to removed them.
- *6. Control box houses high-voltage parts. Before inspecting the inside of the control box, turn off the power, keep the unit off for at least 10 minutes, and confirm that the voltage of the connector RYPN has dropped to DC20V or less.
- *7. Control board LED display.

LED2	Normal operation (LED/Normal)	In operation (L)/In stop (Unit)
LED3	SW4-1 to SW4-6 OFF	Function setting by SW4 enable (L)/disable (Unit)
LED101	Normal operation (L)/IC Error (Unit)	

Model name	Appliance
PURY,TURY	'8 do not exist
PURY,TURY	'11 do not exist
PURY,TURY	LEV20

Model name	Appliance
PURY,TURY	'8 do not exist
PURY,TURY	'11 do not exist
PURY,TURY	LEV20

*8. Difference of appliance.
 *9. Difference of appliance.

<Symbol explanation>

Symbol	Explanation
Z/S14	4-way valve
Z/S14b	Cooling/Heating switching
Z/S14c	Compressor capacity control (only PURY model)
63H1	Cooling/Heating switching
63H1	High pressure protection for the outdoor unit
63HS1	Discharge pressure
63LS	Pressure sensor
ACC1/ACC2	Low pressure
C/C-7	Capacitor (inverter main circuit)
DOL	Choke coil (for high frequency noise reduction)
LEV1 *10	HIC bypass Controls refrigerant flow in HIC circuit
LEV2a/b	Linear expansion valve
LEV20 *9	Pressure control/Refrigerant flow rate control
LEV4 *12	Pressure control/Refrigerant flow rate control
LEV9 *9,10	For opening/closing the injection circuit
MF1	Heat exchanger for inverter
RS101/203	Fan motor (or cooling in control box)
SV1a	Resistor
SV2	For inrush current prevention
SV9 *8	Solenoid valve
SV10 *8	For opening/closing the bypass circuit under the O/S
SV14 *11	For opening/closing the bypass circuit
SV15 *11	For changing refrigerant flow (cooling/heating)
TB1	Terminal block
TB2	Power supply
TB3	Heater transmission line
TB7	Indoor/Outdoor transmission line
TH2 *8	Central control transmission line
TH3	Subcool bypass outlet temperature
TH4	Pipe temperature
TH5	Subcool liquid refrigerant temperature
TH7	Subcool liquid refrigerant temperature
TH8	O/A temperature
TH15	Compressor shell bottom temperature
TH15	IPM temperature
X901-X903	Magnetic relay (inverter main circuit)
Z22.24.25	Function setting connector

*11. Difference of appliance.
 Model name Appliance
 PURY-EP,TURY,TURY *11 do not exist
 PURY-EP,TURY *11 do not exist
 PURY-EP,TURY *11 do not exist

PURY-EP168TNU-A(-BS)

PURY-EP-T(S)NU-A, Y(S)NU-A

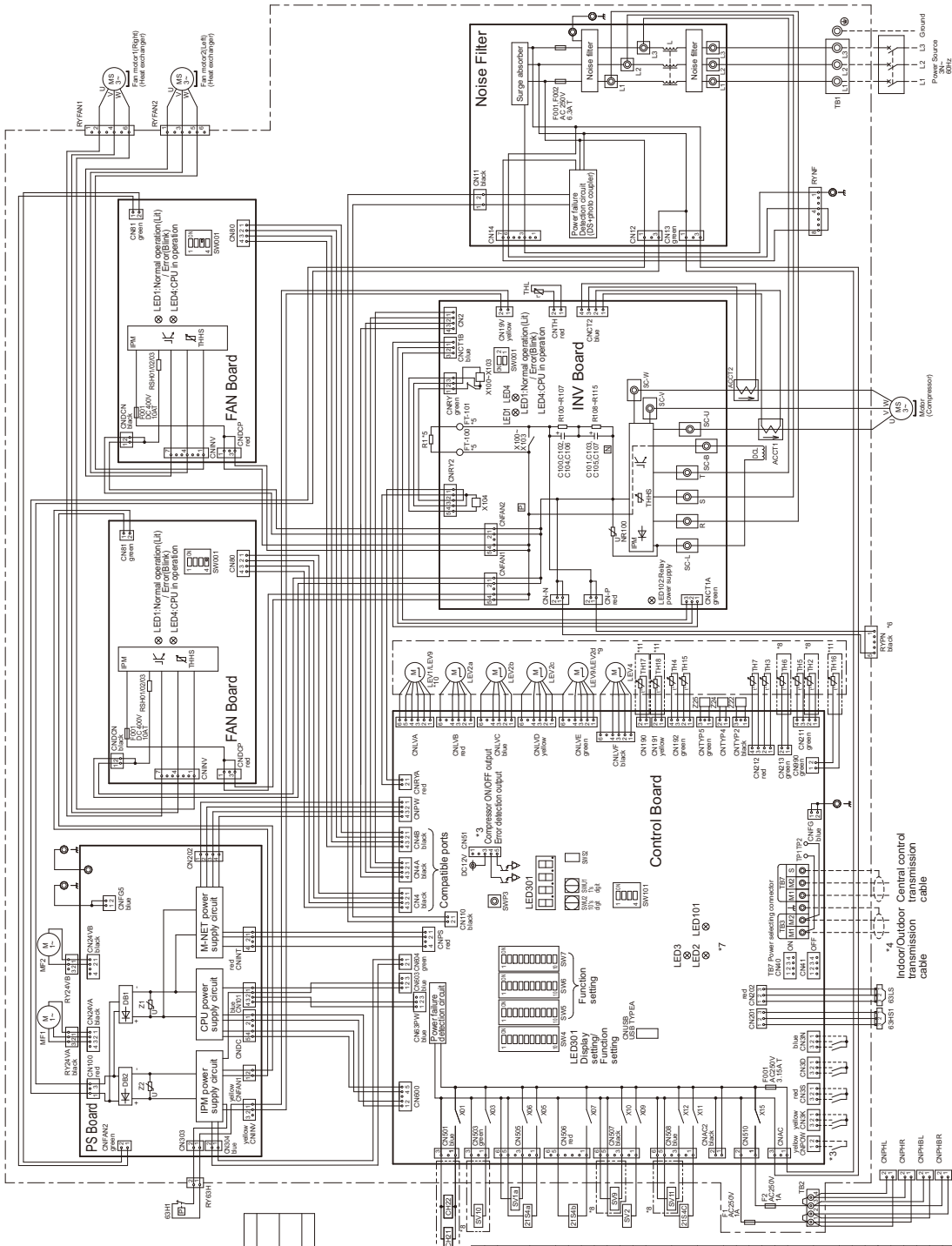

- *1. Single-dotted lines indicate wiring not supplied with the unit.
- *2. Dot-dash lines indicate the control box boundaries.
- *3. Refer to the Data book for connecting input/output signal connectors.
- *4. Daisy-chain terminals (TB3) on the outdoor units in the same refrigerant system together.
- *5. Faston terminals have a locking function. Make sure the terminals are securely locked in place after insertion. Press the tab on the terminals to removed them.
- *6. Control box houses high-voltage parts. Before inspecting the inside of the control box, turn off the power, keep the unit off for at least 10 minutes, and confirm that the voltage of the connector RYPN has dropped to DC20V or less.
- *7. Control board LED display.

LED2	Normal operation(LED/Err/Bk)
LED3	SW6-10 is OFF and In operation(LV/in stop)(Unit)
LED4	SW4-1-10 are OFF (Subsable)(Unit)
LED101	Normal operation(LV/C Err)(Unit)

- *8. Difference of appliance.

Model name	Appliance
PURY,TURY	'8 exists
PURY,TURY	LEV1
PURY,TURY	LEV9
- *9. Difference of appliance.

Model name	Appliance
PURY,TURY	'11 do not exist
PURY,TURY	'11 exists
PURY,TURY	LEV24
- *10. Difference of appliance.

Model name	Appliance
PURY,TURY	'8 exists
PURY,TURY	LEV1
PURY,TURY	LEV9
- *11. Difference of appliance.

Model name	Appliance
PURY,TURY	'11 do not exist
PURY,TURY	'11 exists
PURY,TURY	LEV24

<Symbol explanation>

Symbol	Explanation
Z1S4b	Cooling/heating switching
Z1S4Uc	High pressure capacity control(only PURY model)
63H1	Cooling/heating switching
63H1	High pressure protection for the outdoor unit
63HS1	Discharge pressure
63LS	Pressure sensor
ACCT1,ACCT2	Current sensor(AC)
C100-5,7,11	Capacitor (inverter main circuit)
C100-5,7,11	Capacitor (for heating the accumulator)
DOL	DC reactor
LEV1~10	Choke coil (for high frequency noise reduction)
LEV24a,b,c	HIC bypass controls refrigerant flow in HIC circuit
LEV24t~9	Pressure control, Refrigerant flow rate control
LEV4	Pressure control, Refrigerant flow rate control
LEV9~9,10	For opening/closing the injection circuit
R1	Heat exchanger for inverter
MFT,2	Fan motor(for cooling in control box)
RSH010/20/3	Resistor
SV1a	For inrush current prevention
SV2	Solenoid valve
SV9~8	For opening/closing the bypass circuit under the O/S
SV10~8	For opening/closing the discharge suction bypass
SV11~8	For continuous heating
TB1	Power supply
TB2	Heater transmission line
TB3	Indoor/Outdoor transmission line
TB7	Central control transmission line
TH2~8	Subcool bypass outlet temperature
TH3	Pipe temperature
TH4	Discharge pipe temperature
TH5	ACC inlet pipe temperature
TH6~8	Subcooled liquid refrigerant temperature
TH9	Condenser liquid refrigerant temperature
TH16~11	Compressor skid bottom temperature
TH17~11	Accumulator temperature (Bottom)
TH18~11	Accumulator temperature (Middle)
THHS	Accumulator temperature (Hi)
THHS	IPM temperature
X101~X 03	Magnetic relay(inverter main circuit)
Z22,24,25	Function setting connector

PURY-EP192, 216, 240TNU-A(-BS)

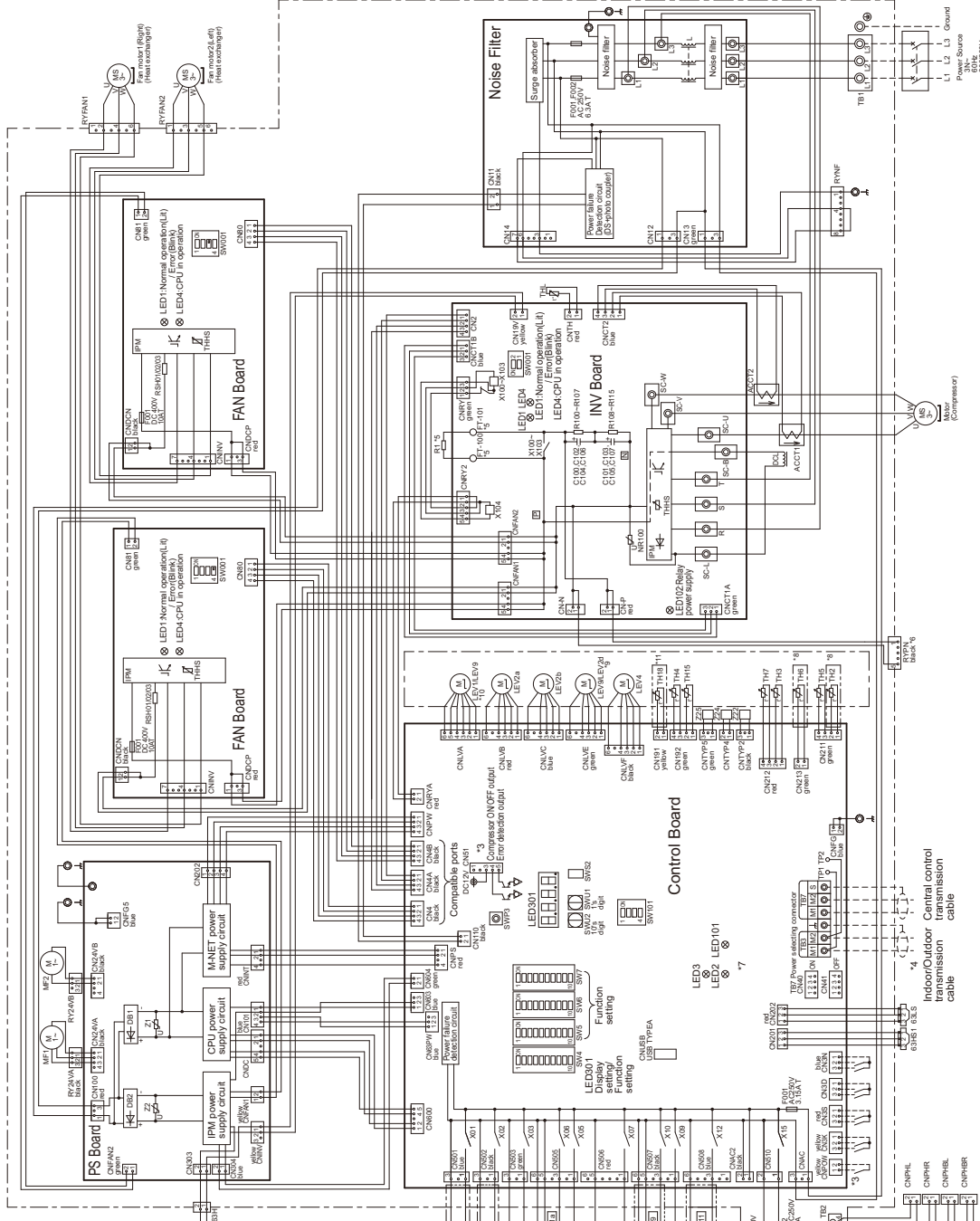

- *1. Single-dotted lines indicate wiring not supplied with the unit.
- *2. Dot-dash lines indicate the control box boundaries.
- *3. Refer to the Data book for connecting input/output signal connectors.
- *4. Daisy-chain terminals (TB3) on the outdoor units in the same refrigerant system together.
- *5. Faston terminals have a locking function. Make sure the terminals are securely locked in place after insertion. Press the tab on the terminals to removed them.
- *6. Control box houses high-voltage parts. Before inspecting the inside of the control box, turn off the power, keep the unit off for at least 10 minutes, and confirm that the voltage of the connector RYPN has dropped to DC20V or less.
- *7. Control board LED display.
 - LED3 Normal operation(LED/Blank)
 - LED4 SW4-10 is OFF and In operation(LED in stop/Unit)
 - LED5 SW4-10 is ON OFF
 - LED6 SW4-10 is ON
 - LED7 Normal operation(LED/Blank)
 - LED8 SW4-10 is OFF and In operation(LED in stop/Unit)
 - LED9 SW4-10 is ON OFF
 - LED10 SW4-10 is ON
 - LED11 Normal operation(LED/Blank)
 - LED12 SW4-10 is OFF and In operation(LED in stop/Unit)
 - LED13 SW4-10 is ON OFF
 - LED14 SW4-10 is ON

- *8. Difference of appliance.
 - Model name Appliance
 - PURY, TUR, Y '8 exist
 - PURY, TUR, Y '9 do not exist
- *9. Difference of appliance.
 - Model name Appliance
 - PURY, TUR, Y '11 do not exist
 - PURY, TUR, Y '11 exist
 - PURY, TUR, Y '11 exist
- *10. Difference of appliance.
 - Model name Appliance
 - PURY, TUR, Y '8 exist
 - PURY, TUR, Y '9 do not exist
- *11. Difference of appliance.
 - Model name Appliance
 - PURY, TUR, Y '11 do not exist
 - PURY, TUR, Y '11 exist

<Symbol explanation>

Symbol	Explanation
21SA	4-way valve
21SAb	Coil/heating switching
63H1	Heat exchanger capacity control(only PURY mode)
63H1	High pressure protection for the Cooling/heating switching
63H1	Outdoor unit
63LS	Pressure sensor
63LS	Discharge pressure sensor
AGCT1/AGCT2	Current sensor(ACC)
C100-C107	Capacitor (inverter main circuit)
CH21 *11	Belt heater(for heating the accumulator)
DCL	DC reactor
LEV1 *10	Choke coil (for high frequency noise reduction)
LEV2a,b	H/C bypass. Controls refrigerant flow in H/C circuit
LEV2d *9	Pressure control. Refrigerant flow rate control
LEV4	Pressure control. Refrigerant flow rate control
LEV4 *9, 10	Pressure control. Refrigerant flow rate control
ME1.2	Heat exchanger for inverter
R1	Fan motor(for cooling in control box)
RS401/02/03	Resistor
SV1a	For inrush current prevention
SV2	For current detection
SV3 *11	For opening/closing the bypass circuit under the O/S
SV3 *8	For opening/closing the discharge suction bypass
SV11 *8	For opening/closing the bypass circuit
TB1	For continuous heating
TB2	Power supply
TB3	Heater transmission line
TB7	Indoor/Outdoor transmission line
TH2 *8	Central control transmission line
TH3	Subcool bypass outlet temperature
TH4	Pipe temperature
TH4	Discharge pipe temperature
TH5 *8	ACC inlet pipe temperature
TH7	Discharge liquid refrigerant temperature
TH15	Compressor shell bottom temperature
TH18 *11	Accumulator temperature (HI)
THHS	IPM temperature
X101-X103	Magnetic relay(inverter main circuit)
Z22, 24, 25	Function setting connector

PURY-EP72YNU-A(-BS)

PURY-EP-T(S)NU-A, Y(S)NU-A

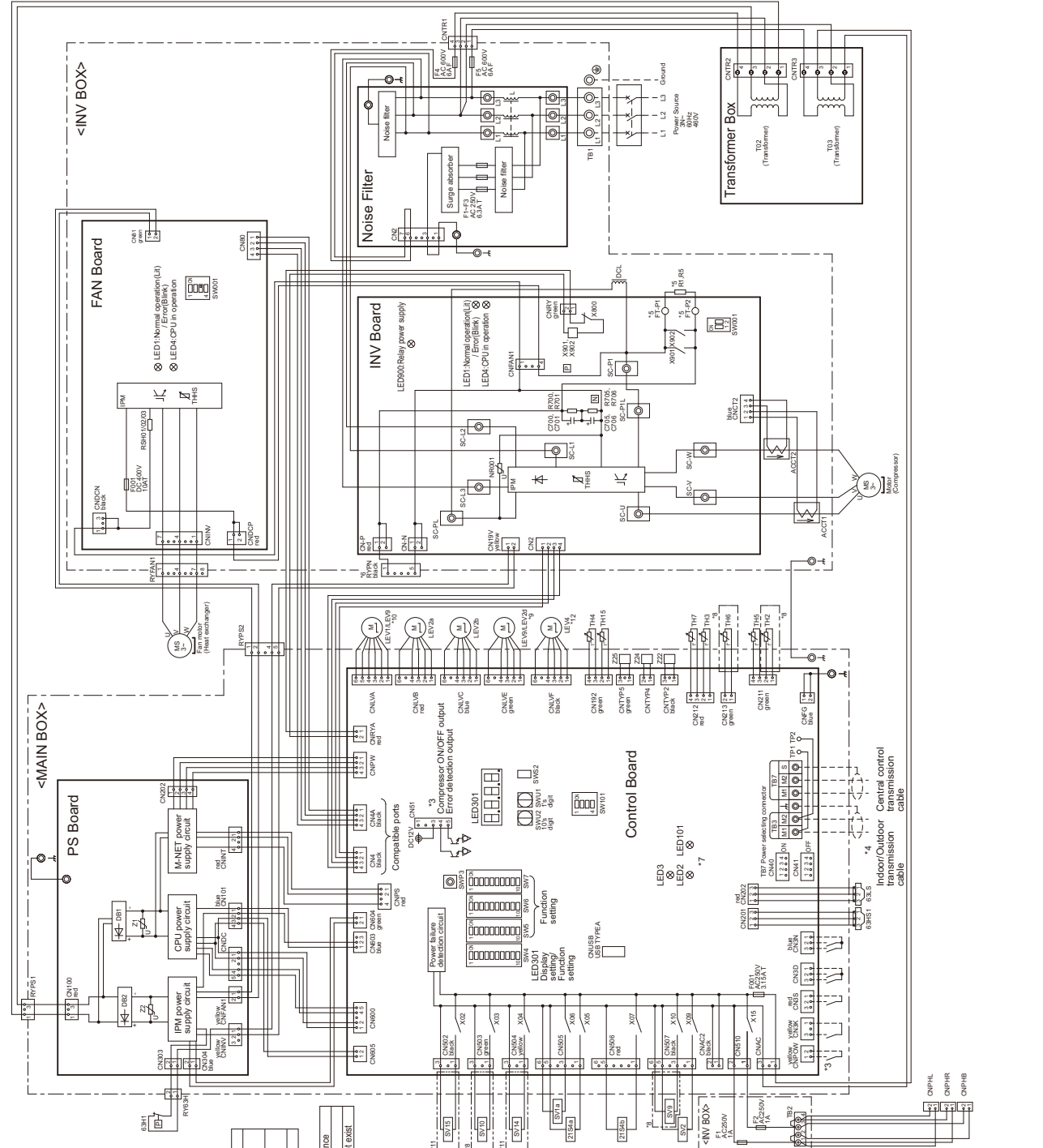

- *1. Single-dotted lines indicate wiring not supplied with the unit.
- *2. Dot-dash lines indicate the control box boundaries.
- *3. Refer to the Data book for connecting input/output signal connectors.
- *4. Daisy-chain terminals (TB3) on the outdoor units in the same refrigerant system together.
- *5. Faston terminals have a locking function. Make sure the terminals are securely locked in place after insertion. Press the tab on the terminals to removed them.
- *6. Control box houses high-voltage parts. Before inspecting the inside of the MAIN BOX or INV BOX, turn off the power, keep the unit off for at least 10 minutes, and confirm that the voltage of the connector RYPN on INV BOX has dropped to DC20V or less.
- *7. Control board LED display.

LED2	Normal operation (LED root/Blank)
LED3	SW6-10 is OFF and in operation (L/L in stop/Unit)
LED3	SW6-10 is ON Function setting by SW4 enable(L)/disable(Unit)
- *8. Difference of appliance.

Model name	Appliance
PURY/TURY	*9 exist
PURY/TURY	*9 do not exist
- *9. Difference of appliance.

Model name	Appliance
PURY/TURY	LEV9
PURY/TURY	LEV24
- *10. Difference of appliance.

Model name	Appliance
PURY/TURY	LEV1
PURY/TURY	LEV3
PURY/TURY/TURY/TURY	LEV5/3 exist
PURY/TURY	*11 exist
- *11. Difference of appliance.

Model name	Appliance
PURY/TURY/TURY/TURY	LEV5/3 exist
PURY/TURY	*11 exist

<Symbol explanation>

Symbol	Explanation
21S4a	4-way valve
21S4b	Cooling/Heating switching Heat exchanger capacity control(only PURY model)
63H1	Pressure switch
63HS1	Pressure sensor
63LS	Discharge pressure
ACCT/ACG2	Current sensor(AC)
C700/C701	Capacitor(inverter main circuit)
DC/L	DC reactor
LEV1	Choke coil (for high frequency noise reduction)
LEV2a,b	Linear expansion valve
LEV2d	Pressure control/Refrigerant flow rate control
LEV2d	Pressure control/Refrigerant flow rate control
LEV4	Pressure control/Refrigerant flow rate control
LEV9	Four opening/closing the injection circuit
RT.5	Heat exchanger for inverter
RS40/02/03	For mush current prevention
SV1a	For current detection
SV2	For opening/closing the bypass suction bypass
SV9	For opening/closing the bypass circuit
SV14,15	For continuous heating/cooling/heating
TB1	Power supply
TB2	Heater transmission line
TB3	Indoor/Outdoor transmission line
TB7	Central control transmission cable
TH2	Subcool bypass outlet temperature
TH3	Pipe temperature
TH4	Subcool inlet pipe temperature
TH5	AGC inlet pipe temperature
TH6	Subcooled liquid refrigerant temperature
TH7	OA temperature
TH8	Compressor shell bottom temperature
TH9	IPM temperature
X901/X902	Magnetic relay(inverter main circuit)
Z2Z,Z24,Z25	Function setting connector

PURY-EP96, 120, 144YNU-A(-BS)

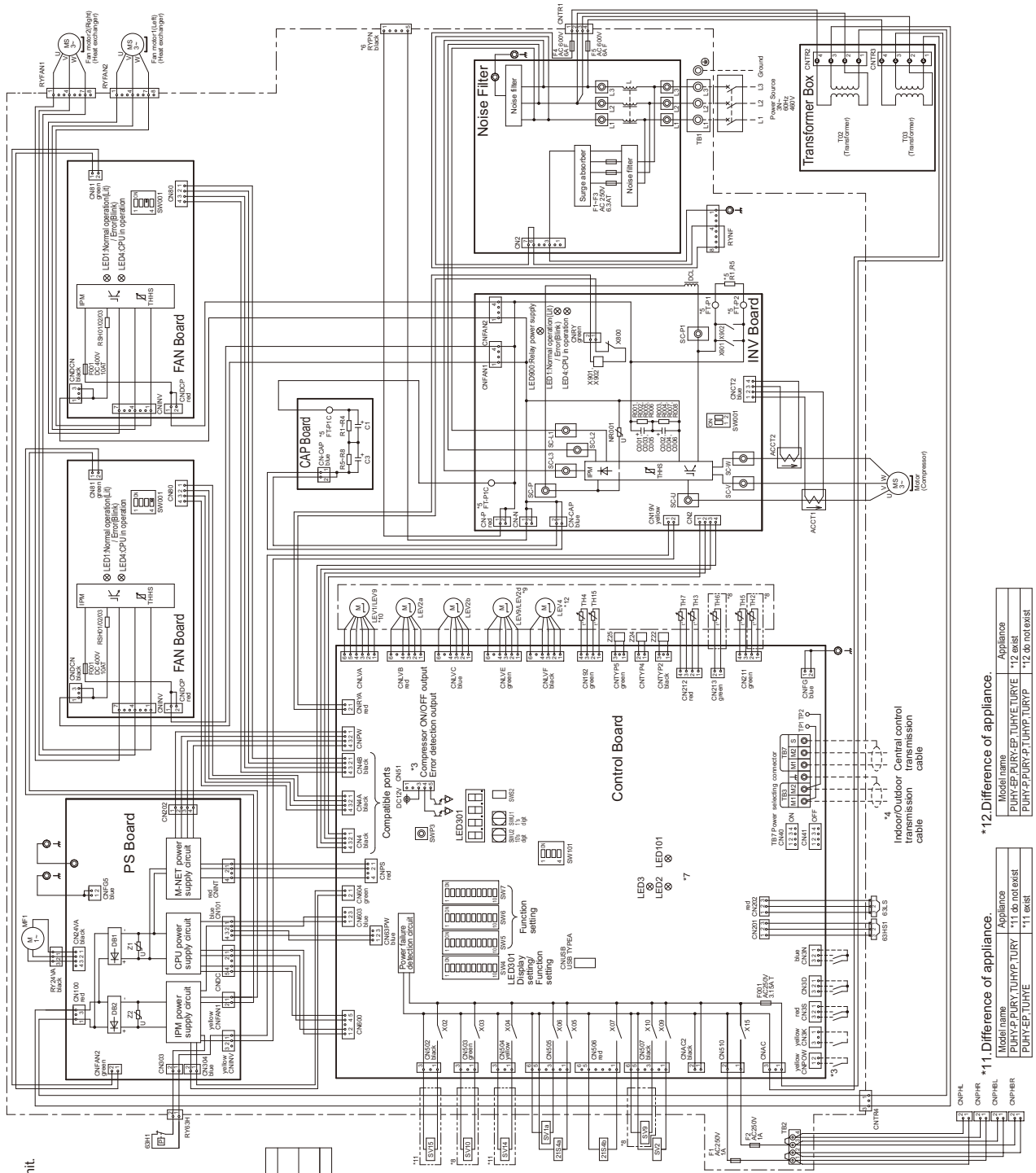

- *1. Single-dotted lines indicate wiring not supplied with the unit.
- *2. Dot-dash lines indicate the control box boundaries.
- *3. Refer to the Data book for connecting input/output signal connectors.
- *4. Daisy-chain terminals (TB3) on the outdoor units in the same refrigerant system together.
- *5. Faston terminals have a locking function. Make sure the terminals are securely locked in place after insertion. Press the tab on the terminals to remove them.
- *6. Control box houses high-voltage parts. Before inspecting the inside of the control box, turn off the power, keep the unit off for at least 10 minutes, and confirm that the voltage of the connector RYPN has dropped to DC20V or less.
- *7. Control board LED display.

LED3	Normal operation (L)/Error (Blink)
LED3	SW6-10 is OFF and in operation (L)/In stop (Unit)
LED3	SW6-10 is OFF Function setting by SW4
LED3	SW6-10 is ON enable (L)/Disable (Unit)
LED101	Normal operation (L)/IC Error (Unit)

Model name	Appliance
PURY-TURV	LEV9
PURY-TURV	LEV20

Model name	Appliance
PURY-TURV	*12 exist
PURY-P.PURY-P.TURV	*12 do not exist

Model name	Appliance
PURY-EP-TURV	*11 do not exist
PURY-EP-TURV	*11 exist

Symbol	Explanation
Z1S4a	4-way valve
63H1	Cooling/Heating switching
63H1	Heat exchanger capacity control (only)
63H1	Cooling/Heating switching
63HS1	High pressure protection for the outdoor unit
63LS	Discharge pressure
63LS	Low pressure
ACT.ACCT2	Current sensor (AC)
C1.C3	Capacitor (inverter main circuit)
C001-C006	DC reactor
DCL	Choke coil (for high frequency noise reduction)
LEV1 *10	Linear expansion valve
LEV2a,b	Pressure control (Refrigerant flow rate control)
LEV24 *9	Pressure control (Refrigerant flow rate control)
LEV4 *12	For opening/closing the injection circuit
LEV9 *9,10	Heat exchanger for inverter
MF1	Fan motor (for cooling in control box)
R1.5	Resistor
RS101/02/03	Solenoid valve
SV1a	For opening/closing the bypass circuit under the O/S
SV2	For opening/closing the discharge suction bypass
SV9 *8	For opening/closing the bypass circuit
SV10 *8	For opening/closing the bypass circuit (cooling/heating)
SV14, 15 *11	For opening/closing the bypass circuit (cooling/heating)
TB1	Terminal block
TB2	Heater transmission line
TB3	Indoor/Outdoor transmission line
TB7	Central control transmission line
TH2 *8	Subcool bypass outlet temperature
TH3	Pipe temperature
TH4	Discharge pipe temperature
TH5	ACC inlet pipe temperature
TH6 *8	Subcooled liquid refrigerant temperature
TH7	OA temperature
TH15	Indoor temperature
X01, X02	Compressor shaft bottom temperature
X001-X002	Magnetic relay (over the main circuit)
Z22,24,25	Function setting connector

*11. Difference of appliance.
 Model name Appliance
 PURY-EP-TURV *11 do not exist
 PURY-EP-TURV *11 exist

*12. Difference of appliance.
 Model name Appliance
 PURY-EP-TURV *12 exist
 PURY-P.PURY-P.TURV *12 do not exist

PURY-EP168YNU-A(-BS)

PURY-EP-T(S)NU-A, Y(S)NU-A

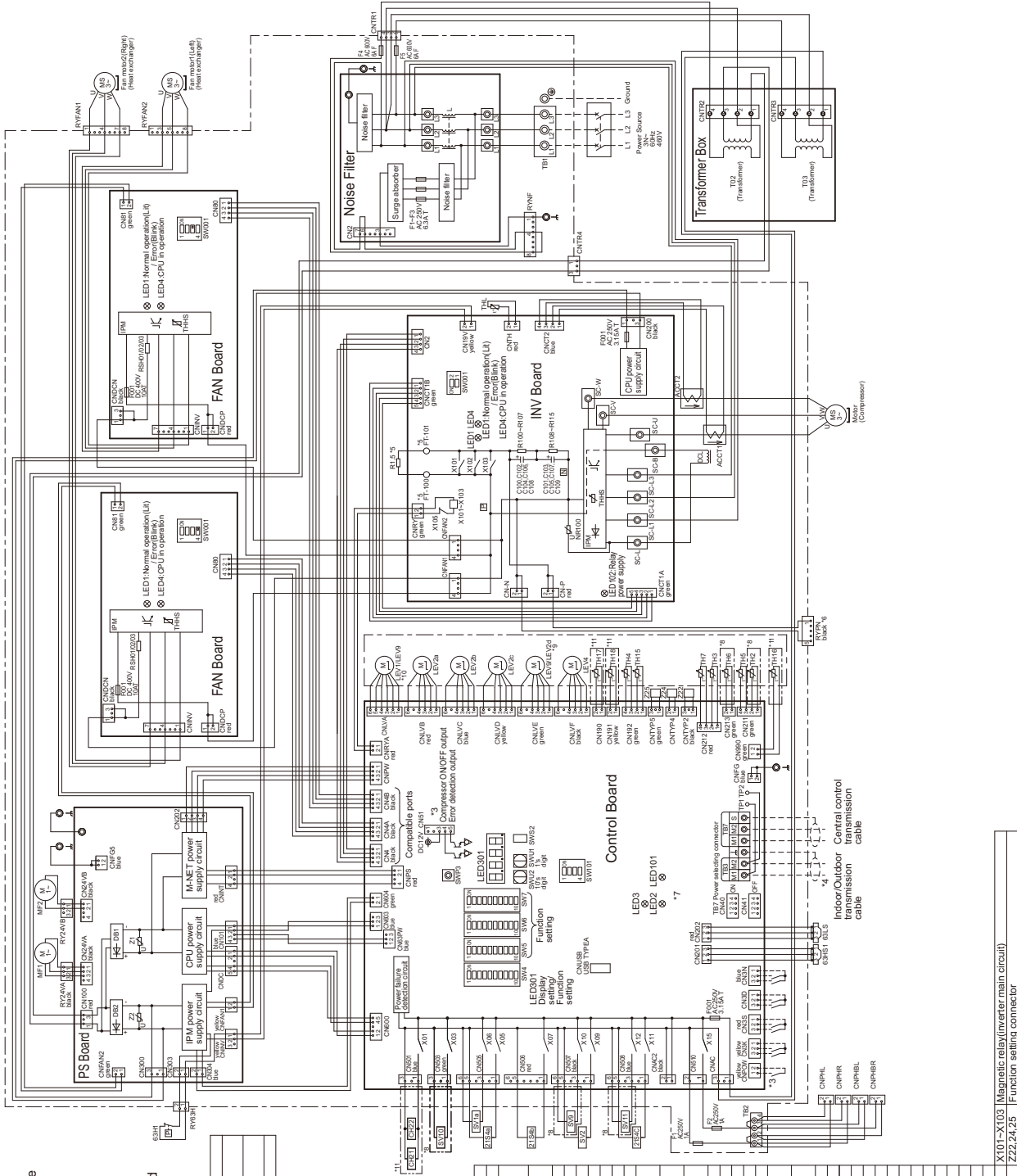

- *1. Single-dotted lines indicate wiring not supplied with the unit.
- *2. Dot-dash lines indicate the control box boundaries.
- *3. Refer to the Data book for connecting input/output signal connectors.
- *4. Daisy-chain terminals (TB3) on the outdoor units in the same refrigerant system together.
- *5. Faston terminals have a locking function. Make sure the terminals are securely locked in place after insertion. Press the tab on the terminals to removed them.
- *6. Control box houses high-voltage parts. Before inspecting the inside of the control box, turn off the power, keep the unit off for at least 10 minutes, and confirm that the voltage of the connector RYPN has dropped to DC20V or less.
- *7. Control board LED display.
 - LED2 Normal operation(L)/Error(Blink)
 - LED3 SW6-10 is OFF and in operation(L)/In stop(Unit)
 - LED4 SW6-10 is ON and in stop(Unit)
 - LED5 SW6-10 is ON Function setting by SW4 enable(L)/Disable(Unit)
 - LED101 Normal operation(L)/C Error(Unit)

- *8. Difference of appliance.

Mode name	Appliance
PURY/URY	300 not exist
PURY/URY	1100 not exist
PURY/URY	9 exist
PURY/URY	11 exist
- *9. Difference of appliance.

Mode name	Appliance
PURY/URY	LEV9
PURY/URY	LEV2
- *10. Difference of appliance.

Mode name	Appliance
PURY/URY	LEV1
PURY/URY	LEV9

<Symbol explanation>

Symbol	Explanation
Z1S4a	4-way valve
Z1S4b.c	Cooling/Heating switching Heat exchanger capacity control(unit) PURY(model)
63H1	Pressure switch
63HS1	High-pressure switching
63LS1	Low-pressure switching
ACC1/ACC2	Discharge pressure sensor
C100-C108	Current sensor(AC)
G2F1,22-11	Capacitor (inverter main circuit)
DCL	Belt heater(for heating the accumulator)
L	DC reactor
LEV1 *10	Choke coil (for high frequency noise reduction)
LEV2a.b.c	HIC bypass control, Refrigerant flow in HIC circuit
LEV2d *9	Pressure control, Refrigerant flow rate control
LEV4	Pressure control, Refrigerant flow rate control
LEV9 *9,10	For opening/closing the injection circuit
M1F.2	Heat exchanger for inverter
R1.5	Fan motor(for cooling in control box)
RS40102/03	Resistor
SV1a	For inrush current prevention
SV2	For opening/closing the bypass circuit under the O/S
SV9 *9	For opening/closing the discharge circuit bypass
SV10.11 *8	For opening/closing the bypass circuit
TB1	For common heating
TB2	Power supply
TB3	Heater transmission line
TB7	Indoor/Outdoor transmission line
TBZ *8	Central control transmission line
TH3	Subcool bypass outlet temperature
TH4	Pipe temperature
TH5	Discharge pipe temperature
TH6 *8	ACC inlet pipe temperature
TH7	Subcooled liquid refrigerant temperature
TH8	OA temperature
TH16	Compressor shell bottom temperature
TH17 *11	Accumulator temperature (Bottom)
TH18 *11	Accumulator temperature (Middle)
TH18 *11	Accumulator temperature (Hi)
THHS	IPM temperature

X101-X103 Magnetic relay(inverter main circuit)
Z22,24,25 Function setting connector

PURY-EP192, 216, 240YNU-A(-BS)

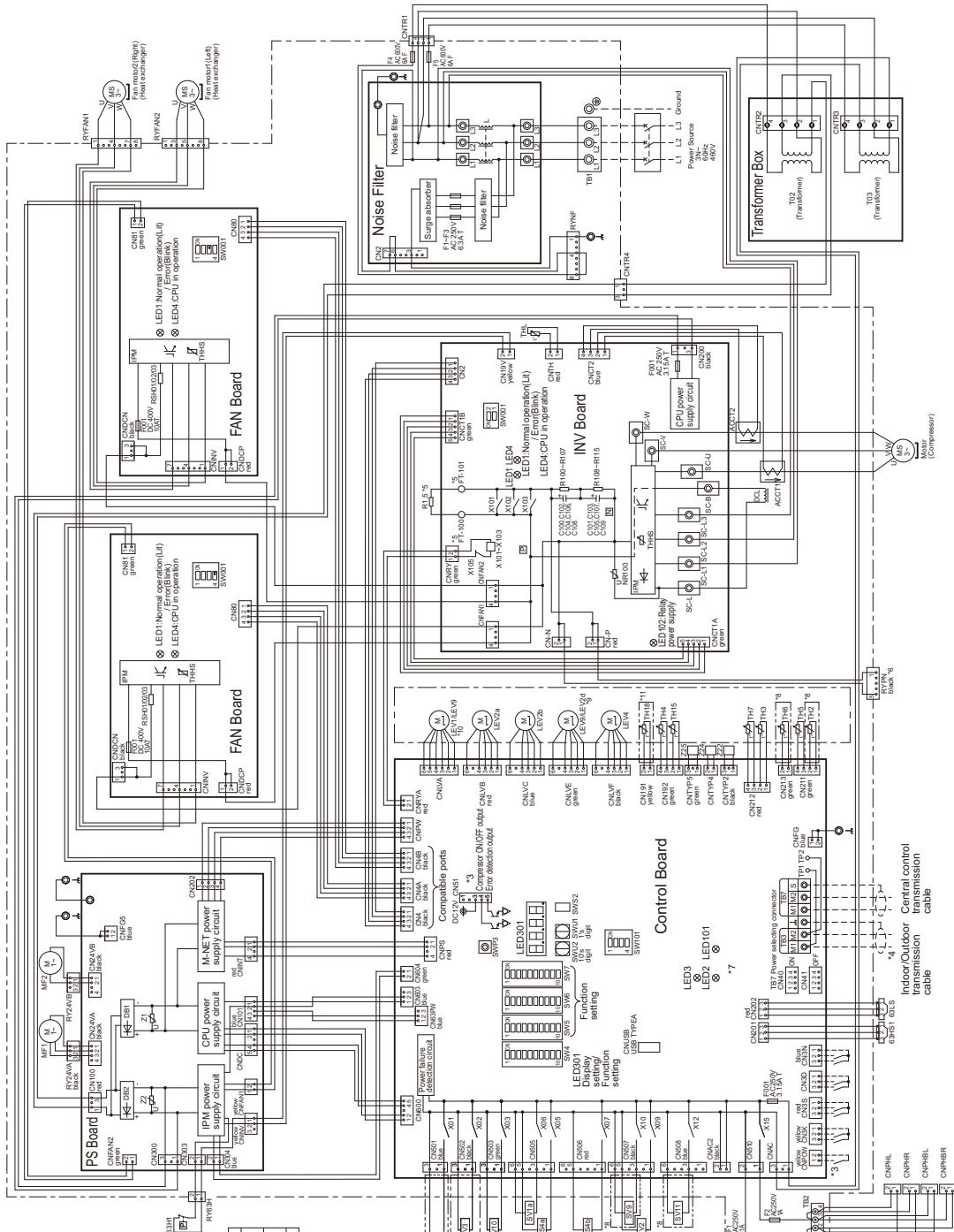

- *1. Single-dotted lines indicate wiring not supplied with the unit.
- *2. Dot-dash lines indicate the control box boundaries.
- *3. Refer to the Data book for connecting input/output signal connectors.
- *4. Daisy-chain terminals (TB3) on the outdoor units in the same refrigerant system together.
- *5. Faston terminals have a locking function. Make sure the terminals are securely locked in place after insertion. Press the tab on the terminals to removed them.
- *6. Control box houses high-voltage parts. Before inspecting the inside of the control box, turn off the power, keep the unit off for at least 10 minutes, and confirm that the voltage of the connector RYPN has dropped to DC20V or less.
- *7. Control board LED display
 - LED3 Normal operation(LED/Err/Blk)
 - LED3 SW4-1 is OFF In operation(Lt/In stop)(Unit)
 - SW6-10 is ON Function setting by SW4 enable(Lt/Disable)(Unit)
 - LED101 Normal operation(Lt/Err/Blk)

*8. Difference of appliance.

Model name	Appliance
PURYTURU	2-in-1
PURYTURU	2-in-1
PURYTURU	2-in-1
PURYTURU	2-in-1

*11. Difference of appliance.

Model name	Appliance
PURYTURU	2-in-1
PURYTURU	2-in-1
PURYTURU	2-in-1
PURYTURU	2-in-1

*9. Difference of appliance.

Model name	Appliance
PURYTURU	2-in-1
PURYTURU	2-in-1
PURYTURU	2-in-1
PURYTURU	2-in-1

*10. Difference of appliance.

Model name	Appliance
PURYTURU	2-in-1
PURYTURU	2-in-1
PURYTURU	2-in-1
PURYTURU	2-in-1

<Symbol explanation>

Symbol	Explanation
Z1S4a	Cooling/heating switching
Z1S4b	Cooling/heating capacity control(only PURY model)
63H1	Pressure switch
63HST	Pressure switch
63LS	Pressure sensor
CG17/ACC7	Current sensor(AC)
CH21-11	Block heater (for outdoor heating the accumulator)
DCL	DC reactor
LEV1-10	Linear expansion valve
LEV2a,b	Choke coil (for high frequency noise reduction)
LEV24-g	HIC bypass Controls refrigerant flow in HIC circuit
LEV4	Pressure control/Refrigerant flow rate control
LEV9-9,10	For opening/closing the injection circuit
R1-1,2	Heat exchanger for inverter
R2	Fan motor(for cooling in control box)
RS01/02/03	Resistor
SV1a	For current detection
SV1a	Solenoid valve
SV2	For opening/closing the bypass suction bypass
SV3-11, SV3-8, SV11-8	For opening/closing the discharge suction bypass
SV11-8	For opening/closing the bypass circuit
TB1	For continuous heating
TB1	Terminal block
TB2	Power supply
TB3	Heater transmission line
TB7	Indoor/Outdoor transmission line
TH2-8	Central control transmission line
TH3	Subcool bypass outlet temperature
TH4	Pipe temperature
TH5	Discharge pipe temperature
TH6-8	CC-1/ing pipe temperature
TH7	Subcool bypass refrigerant temperature
TH8	OA temperature
TH15	Compressor shell bottom temperature
TH18-11	Accumulator temperature (HI)
THHS	IPM temperature
X101-X103	Magnetic relay(inverter main circuit)
Z22-24/25	Function setting connector

5-1. Sound levels in cooling mode

PURY-EP-T(S)NU-A, Y(S)NU-A

Sound level of PURY-EP72T(Y)NU

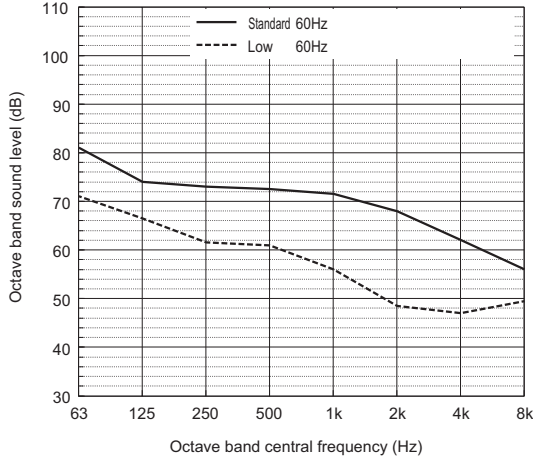

		63	125	250	500	1k	2k	4k	8k	dB(A)
Standard Cooling	60Hz	81.0	74.0	73.0	72.5	71.5	68.0	62.0	56.0	75.5
Low noise mode	60Hz	71.0	66.5	61.5	61.0	56.0	48.5	47.0	49.5	62.0

When Low noise mode is set, the A/C system's capacity is limited. The system could return to normal operation from Low noise mode automatically in the case that the operation condition is severe.

Sound level of PURY-EP96T(Y)NU

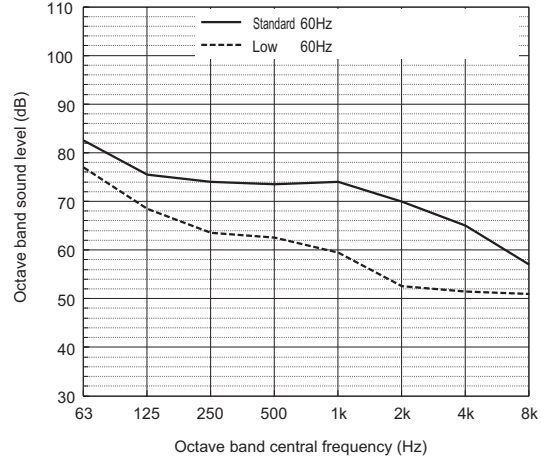

		63	125	250	500	1k	2k	4k	8k	dB(A)
Standard Cooling	60Hz	82.5	75.5	74.0	73.5	74.0	70.0	65.0	57.0	77.5
Low noise mode	60Hz	77.0	68.5	63.5	62.5	59.5	52.5	51.5	51.0	64.5

When Low noise mode is set, the A/C system's capacity is limited. The system could return to normal operation from Low noise mode automatically in the case that the operation condition is severe.

Sound level of PURY-EP120T(Y)NU

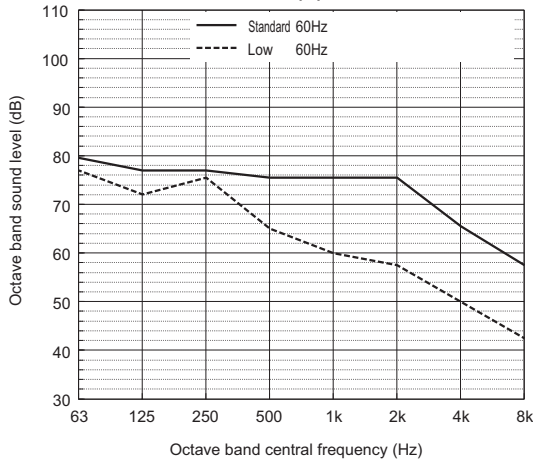

		63	125	250	500	1k	2k	4k	8k	dB(A)
Standard Cooling	60Hz	79.5	77.0	77.0	75.5	75.5	75.5	65.5	57.5	80.5
Low noise mode	60Hz	77.0	72.0	75.5	65.0	60.0	57.5	50.0	42.5	69.5

When Low noise mode is set, the A/C system's capacity is limited. The system could return to normal operation from Low noise mode automatically in the case that the operation condition is severe.

Sound level of PURY-EP144T(Y)NU

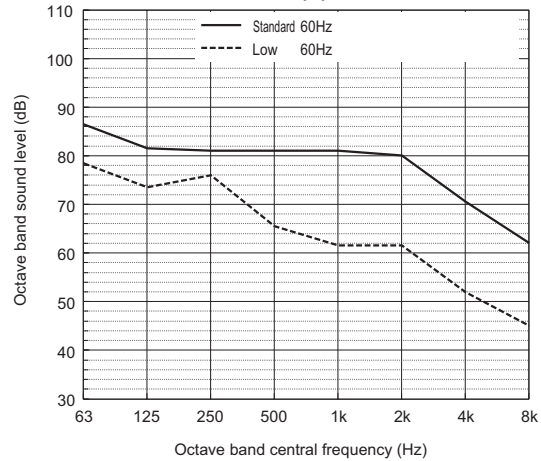

		63	125	250	500	1k	2k	4k	8k	dB(A)
Standard Cooling	60Hz	86.5	81.5	81.0	81.0	81.0	80.0	70.5	62.0	85.5
Low noise mode	60Hz	78.5	73.5	76.0	65.5	61.5	61.5	52.0	45.0	70.5

When Low noise mode is set, the A/C system's capacity is limited. The system could return to normal operation from Low noise mode automatically in the case that the operation condition is severe.

Sound level of PURY-EP168T(Y)NU

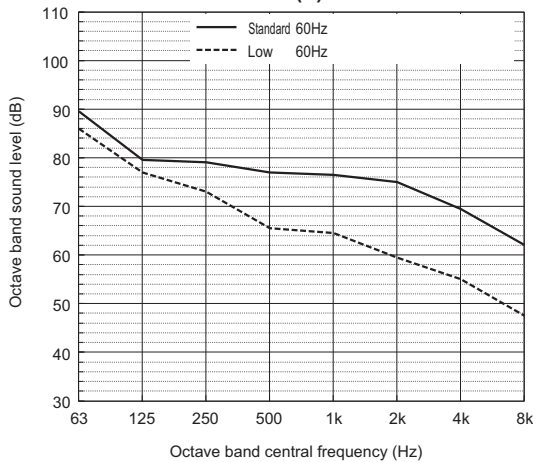

		63	125	250	500	1k	2k	4k	8k	dB(A)
Standard Cooling	60Hz	89.5	79.5	79.0	77.0	76.5	75.0	69.5	62.0	81.5
Low noise mode	60Hz	86.0	77.0	73.0	65.5	64.5	59.5	55.0	47.5	70.5

When Low noise mode is set, the A/C system's capacity is limited. The system could return to normal operation from Low noise mode automatically in the case that the operation condition is severe.

Sound level of PURY-EP192T(Y)NU

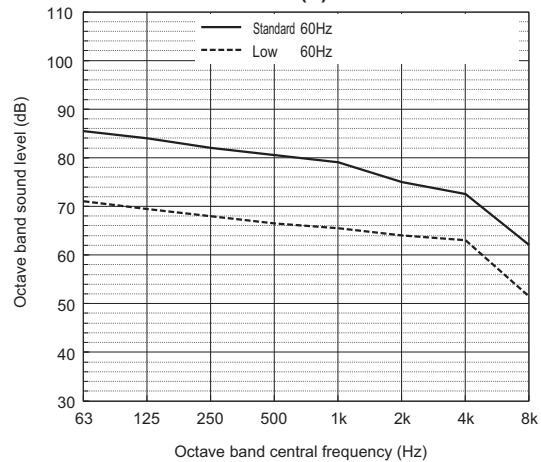

		63	125	250	500	1k	2k	4k	8k	dB(A)
Standard Cooling	60Hz	85.5	84.0	82.0	80.5	79.0	75.0	72.5	62.0	83.5
Low noise mode	60Hz	71.0	69.5	68.0	66.5	65.5	64.0	63.0	51.5	71.0

When Low noise mode is set, the A/C system's capacity is limited. The system could return to normal operation from Low noise mode automatically in the case that the operation condition is severe.

• Depending on the operation conditions, the unit generates noise caused by valve actuation, refrigerant flow, and pressure changes when operating normally. Please consider to avoid location where quietness is required.
For BC controller, it is recommended to be installed in places such as ceilings of corridor, rest rooms and plant rooms.

• The sound values are sound power level (PWL) based on ISO 3744:2010 (r = 3.5 m).

Sound level of PURY-EP216T(Y)NU

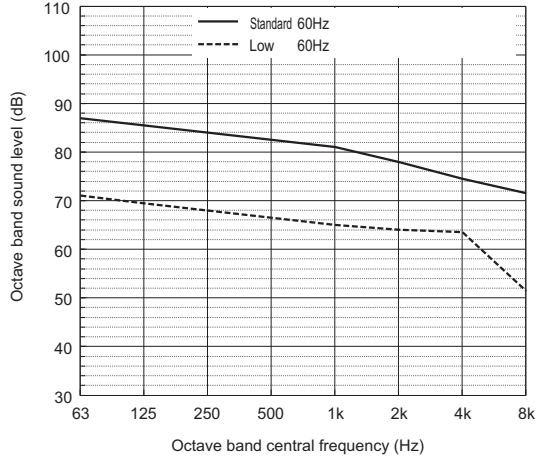

		63	125	250	500	1k	2k	4k	8k	dB(A)
Standard Cooling	60Hz	87.0	85.5	84.0	82.5	81.0	78.0	74.5	71.5	86.0
Low noise mode	60Hz	71.0	69.5	68.0	66.5	65.0	64.0	63.5	51.5	71.0

When Low noise mode is set, the A/C system's capacity is limited. The system could return to normal operation from Low noise mode automatically in the case that the operation condition is severe.

Sound level of PURY-EP240T(Y)NU

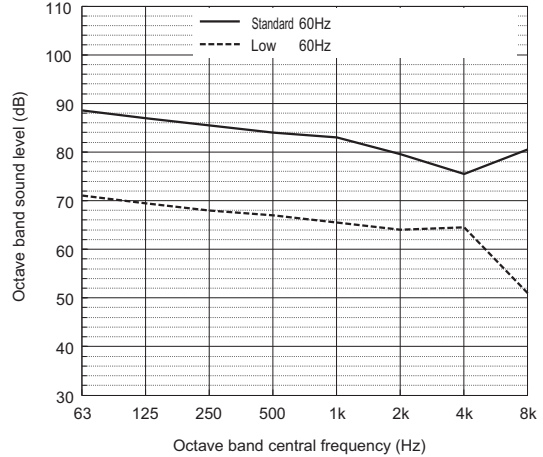

		63	125	250	500	1k	2k	4k	8k	dB(A)
Standard Cooling	60Hz	88.5	87.0	85.5	84.0	83.0	79.5	75.5	80.5	88.0
Low noise mode	60Hz	71.0	69.5	68.0	67.0	65.5	64.0	64.5	51.0	71.5

When Low noise mode is set, the A/C system's capacity is limited. The system could return to normal operation from Low noise mode automatically in the case that the operation condition is severe.

Sound level of PURY-EP192T(Y)SNU

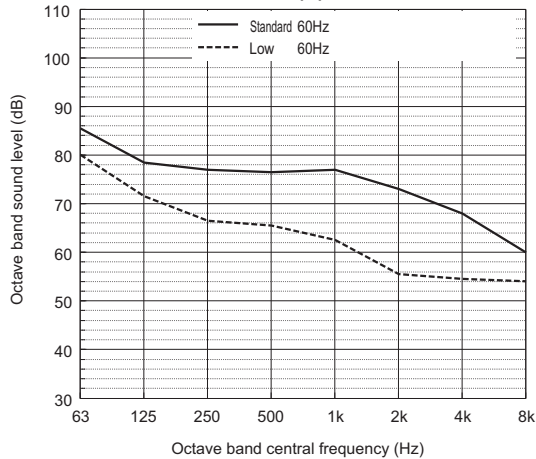

		63	125	250	500	1k	2k	4k	8k	dB(A)
Standard Cooling	60Hz	85.5	78.5	77.0	76.5	77.0	73.0	68.0	60.0	80.5
Low noise mode	60Hz	80.0	71.5	66.5	65.5	62.5	55.5	54.5	54.0	67.5

When Low noise mode is set, the A/C system's capacity is limited. The system could return to normal operation from Low noise mode automatically in the case that the operation condition is severe.

Sound level of PURY-EP216T(Y)SNU

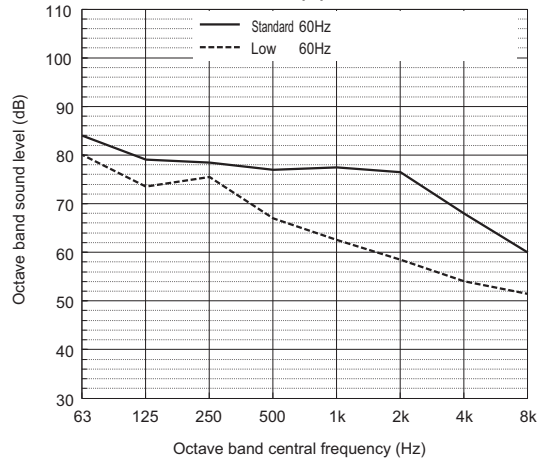

		63	125	250	500	1k	2k	4k	8k	dB(A)
Standard Cooling	60Hz	84.0	79.0	78.5	77.0	77.5	76.5	68.0	60.0	82.0
Low noise mode	60Hz	80.0	73.5	75.5	67.0	62.5	58.5	54.0	51.5	70.5

When Low noise mode is set, the A/C system's capacity is limited. The system could return to normal operation from Low noise mode automatically in the case that the operation condition is severe.

Sound level of PURY-EP240T(Y)SNU

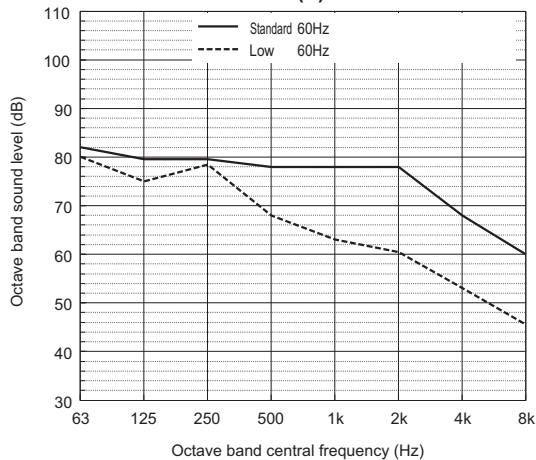

		63	125	250	500	1k	2k	4k	8k	dB(A)
Standard Cooling	60Hz	82.0	79.5	79.5	78.0	78.0	78.0	68.0	60.0	83.0
Low noise mode	60Hz	80.0	75.0	78.5	68.0	63.0	60.5	53.0	45.5	72.5

When Low noise mode is set, the A/C system's capacity is limited. The system could return to normal operation from Low noise mode automatically in the case that the operation condition is severe.

Sound level of PURY-EP264T(Y)SNU

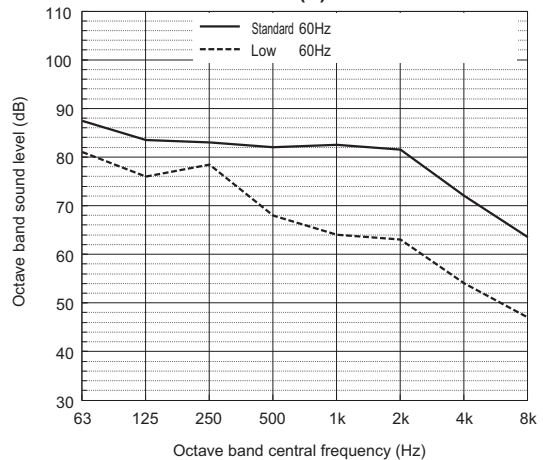

		63	125	250	500	1k	2k	4k	8k	dB(A)
Standard Cooling	60Hz	87.5	83.5	83.0	82.0	82.5	81.5	72.0	63.5	87.0
Low noise mode	60Hz	81.0	76.0	78.5	68.0	64.0	63.0	54.0	47.0	73.0

When Low noise mode is set, the A/C system's capacity is limited. The system could return to normal operation from Low noise mode automatically in the case that the operation condition is severe.

- Depending on the operation conditions, the unit generates noise caused by valve actuation, refrigerant flow, and pressure changes when operating normally. Please consider to avoid location where quietness is required.
For BC controller, it is recommended to be installed in places such as ceilings of corridor, rest rooms and plant rooms.
- The sound values are sound power level (PWL) based on ISO 3744:2010 (r = 3.5 m).

Sound level of PURY-EP288T(Y)SNU

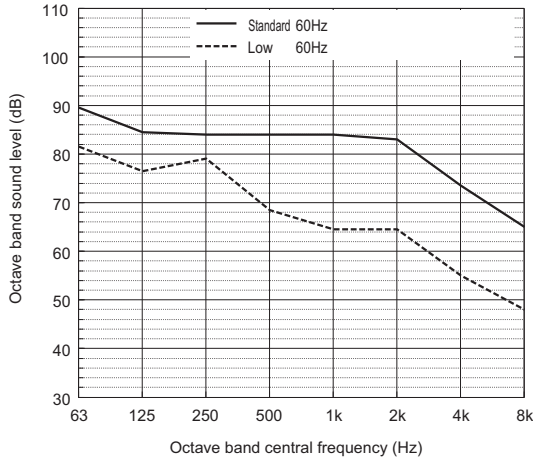

Standard Cooling	60Hz	63	125	250	500	1k	2k	4k	8k	dB(A)
Standard Cooling	60Hz	89.5	84.5	84.0	84.0	84.0	83.0	73.5	65.0	88.5
Low noise mode	60Hz	81.5	76.5	79.0	68.5	64.5	64.5	55.0	48.0	73.5

When Low noise mode is set, the A/C system's capacity is limited. The system could return to normal operation from Low noise mode automatically in the case that the operation condition is severe.

Sound level of PURY-EP312T(Y)SNU

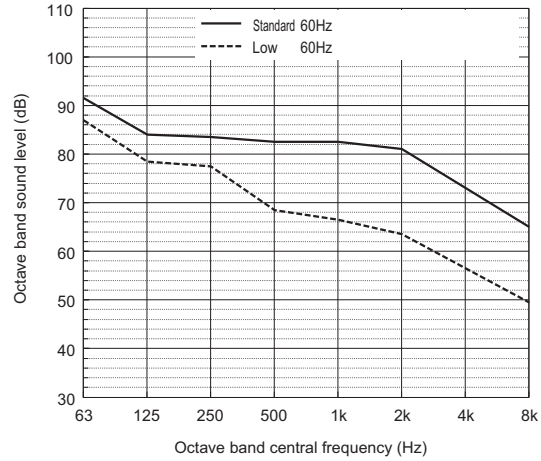

Standard Cooling	60Hz	63	125	250	500	1k	2k	4k	8k	dB(A)
Standard Cooling	60Hz	91.5	84.0	83.5	82.5	82.5	81.0	73.0	65.0	87.0
Low noise mode	60Hz	87.0	78.5	77.5	68.5	66.5	63.5	56.5	49.5	73.5

When Low noise mode is set, the A/C system's capacity is limited. The system could return to normal operation from Low noise mode automatically in the case that the operation condition is severe.

Sound level of PURY-EP336T(Y)SNU

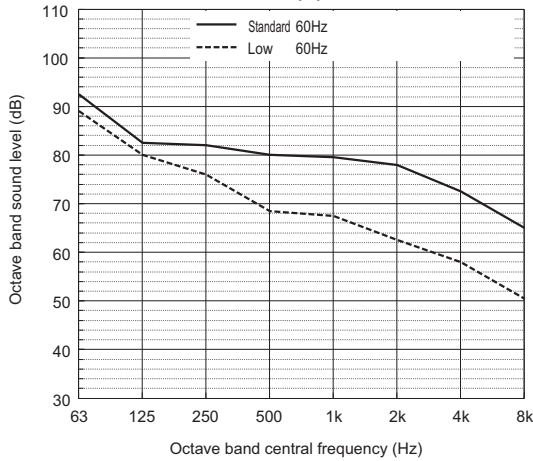

Standard Cooling	60Hz	63	125	250	500	1k	2k	4k	8k	dB(A)
Standard Cooling	60Hz	92.5	82.5	82.0	80.0	79.5	78.0	72.5	65.0	84.5
Low noise mode	60Hz	89.0	80.0	76.0	68.5	67.5	62.5	58.0	50.5	73.5

When Low noise mode is set, the A/C system's capacity is limited. The system could return to normal operation from Low noise mode automatically in the case that the operation condition is severe.

Sound level of PURY-EP384T(Y)SNU

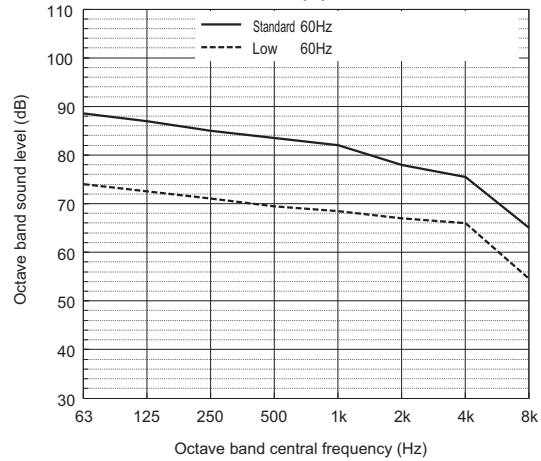

Standard Cooling	60Hz	63	125	250	500	1k	2k	4k	8k	dB(A)
Standard Cooling	60Hz	88.5	87.0	85.0	83.5	82.0	78.0	75.5	65.0	86.5
Low noise mode	60Hz	74.0	72.5	71.0	69.5	68.5	67.0	66.0	54.5	74.0

When Low noise mode is set, the A/C system's capacity is limited. The system could return to normal operation from Low noise mode automatically in the case that the operation condition is severe.

Sound level of PURY-EP432T(Y)SNU

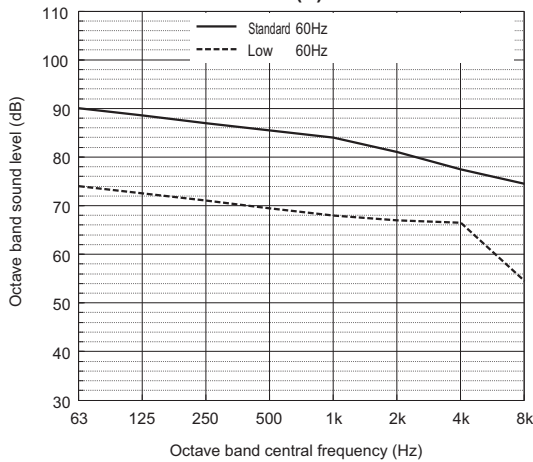

Standard Cooling	60Hz	63	125	250	500	1k	2k	4k	8k	dB(A)
Standard Cooling	60Hz	90.0	88.5	87.0	85.5	84.0	81.0	77.5	74.5	89.0
Low noise mode	60Hz	74.0	72.5	71.0	69.5	68.0	67.0	66.5	54.5	74.0

When Low noise mode is set, the A/C system's capacity is limited. The system could return to normal operation from Low noise mode automatically in the case that the operation condition is severe.

- Depending on the operation conditions, the unit generates noise caused by valve actuation, refrigerant flow, and pressure changes when operating normally. Please consider to avoid location where quietness is required.
- For BC controller, it is recommended to be installed in places such as ceilings of corridor, rest rooms and plant rooms.
- The sound values are sound power level (PWL) based on ISO 3744:2010 (r = 3.5 m).

5-2. Sound levels in heating mode

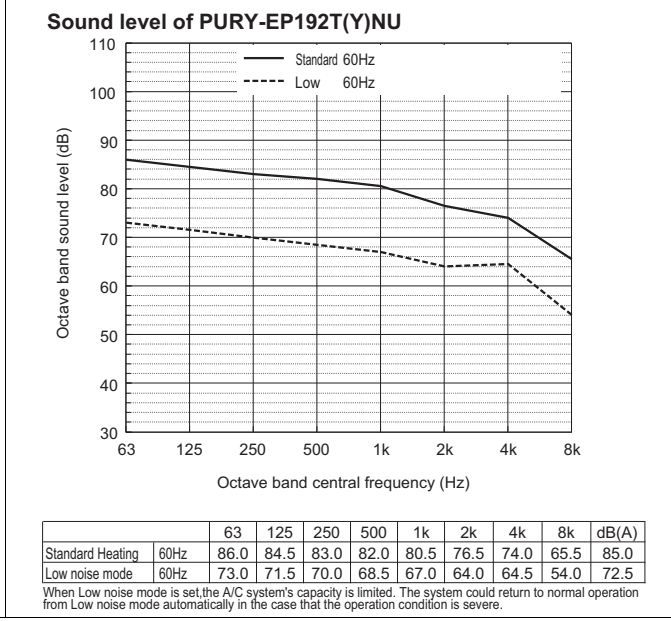
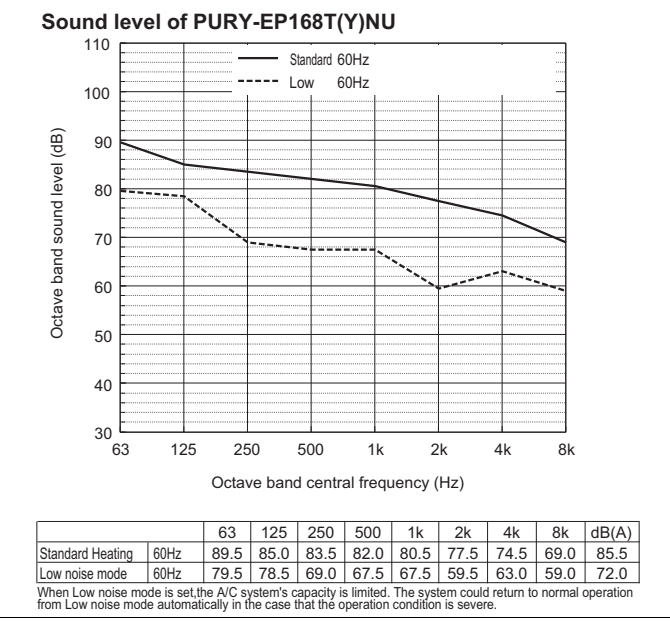
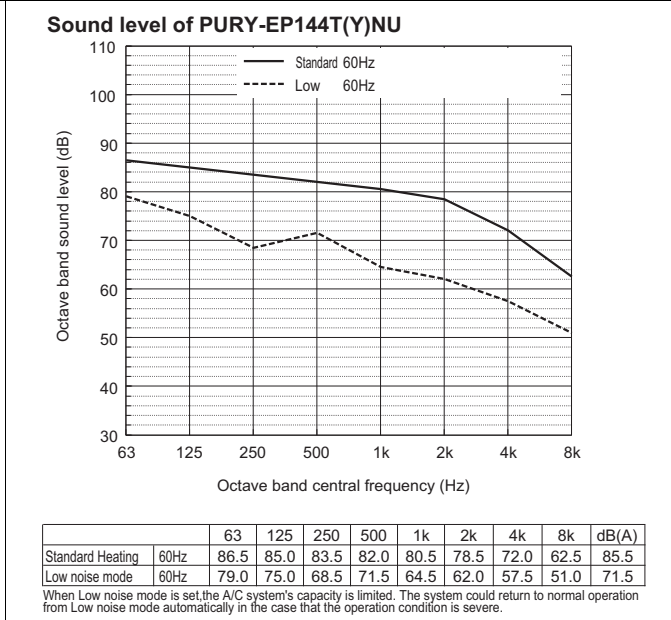
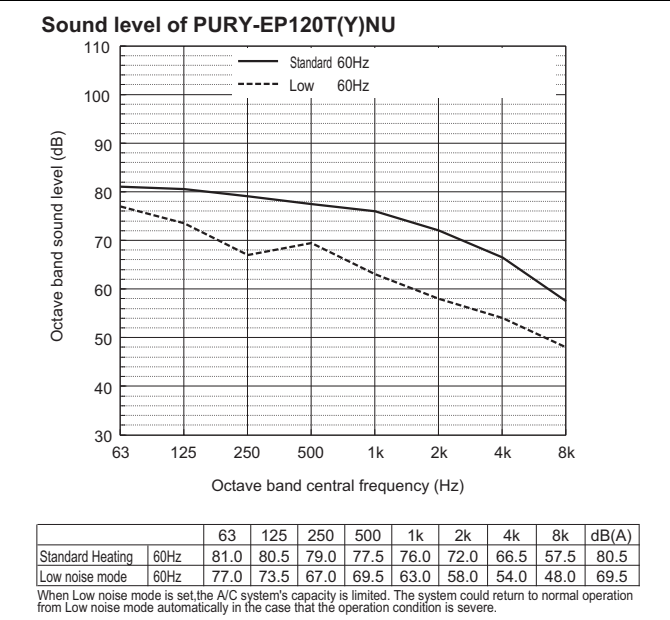
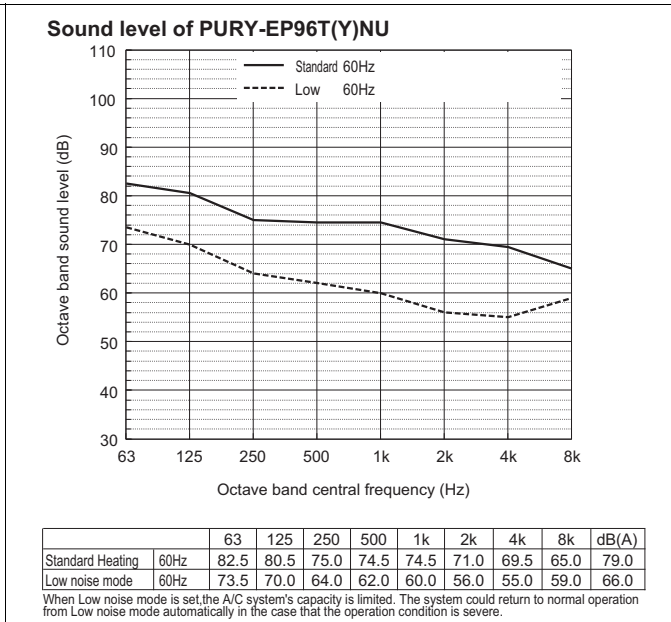
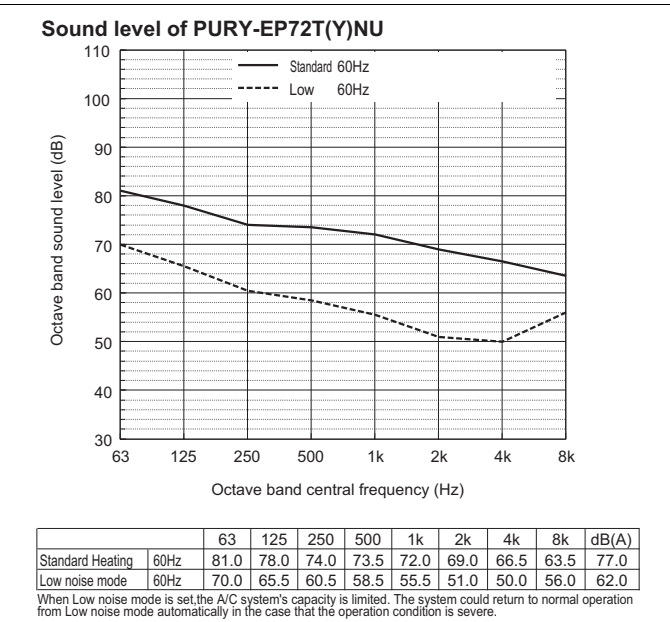

- Depending on the operation conditions, the unit generates noise caused by valve actuation, refrigerant flow, and pressure changes when operating normally. Please consider to avoid location where quietness is required.
- For BC controller, it is recommended to be installed in places such as ceilings of corridor, rest rooms and plant rooms.
- The sound values are sound power level (PWL) based on ISO 3744:2010 (r = 3.5 m).

Sound level of PURY-EP216T(Y)NU

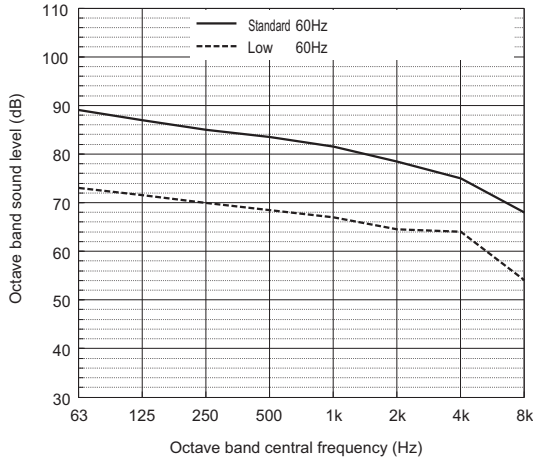

		63	125	250	500	1k	2k	4k	8k	dB(A)
Standard Heating	60Hz	89.0	87.0	85.0	83.5	81.5	78.5	75.0	68.0	86.5
Low noise mode	60Hz	73.0	71.5	70.0	68.5	67.0	64.5	64.0	54.0	72.5

When Low noise mode is set, the A/C system's capacity is limited. The system could return to normal operation from Low noise mode automatically in the case that the operation condition is severe.

Sound level of PURY-EP240T(Y)NU

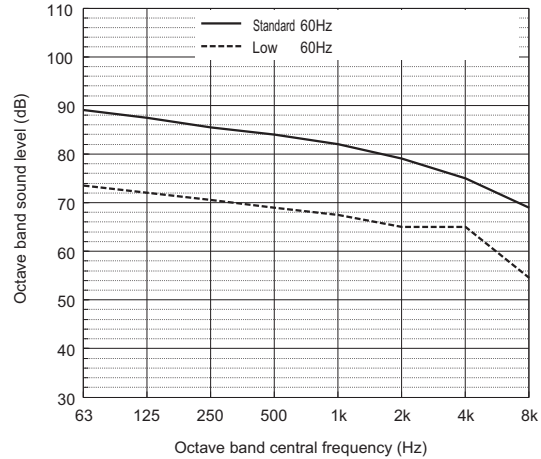

		63	125	250	500	1k	2k	4k	8k	dB(A)
Standard Heating	60Hz	89.0	87.5	85.5	84.0	82.0	79.0	75.0	69.0	87.0
Low noise mode	60Hz	73.5	72.0	70.5	69.0	67.5	65.0	65.0	54.5	73.0

When Low noise mode is set, the A/C system's capacity is limited. The system could return to normal operation from Low noise mode automatically in the case that the operation condition is severe.

Sound level of PURY-EP192T(Y)SNU

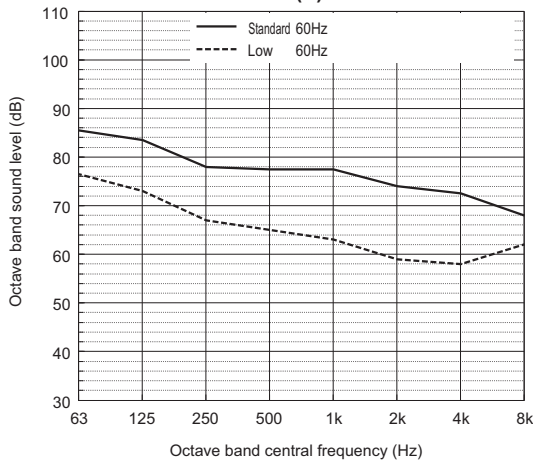

		63	125	250	500	1k	2k	4k	8k	dB(A)
Standard Heating	60Hz	85.5	83.5	78.0	77.5	77.5	74.0	72.5	68.0	82.0
Low noise mode	60Hz	76.5	73.0	67.0	65.0	63.0	59.0	58.0	62.0	69.0

When Low noise mode is set, the A/C system's capacity is limited. The system could return to normal operation from Low noise mode automatically in the case that the operation condition is severe.

Sound level of PURY-EP216T(Y)SNU

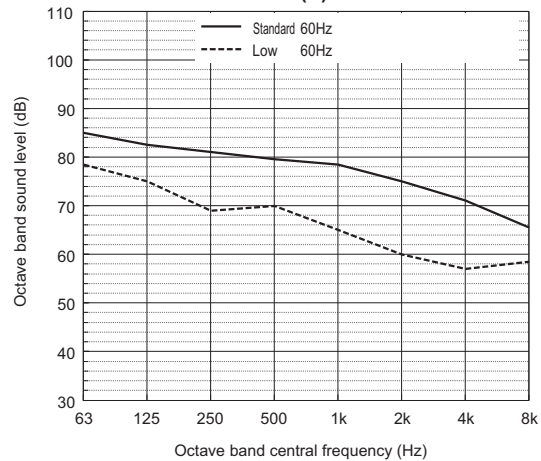

		63	125	250	500	1k	2k	4k	8k	dB(A)
Standard Heating	60Hz	85.0	82.5	81.0	79.5	78.5	75.0	71.0	65.5	83.0
Low noise mode	60Hz	78.5	75.0	69.0	70.0	65.0	60.0	57.0	58.5	71.0

When Low noise mode is set, the A/C system's capacity is limited. The system could return to normal operation from Low noise mode automatically in the case that the operation condition is severe.

Sound level of PURY-EP240T(Y)SNU

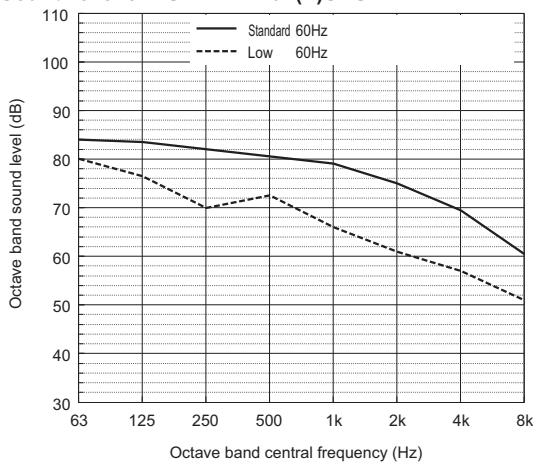

		63	125	250	500	1k	2k	4k	8k	dB(A)
Standard Heating	60Hz	84.0	83.5	82.0	80.5	79.0	75.0	69.5	60.5	83.5
Low noise mode	60Hz	80.0	76.5	70.0	72.5	66.0	61.0	57.0	51.0	72.5

When Low noise mode is set, the A/C system's capacity is limited. The system could return to normal operation from Low noise mode automatically in the case that the operation condition is severe.

Sound level of PURY-EP264T(Y)SNU

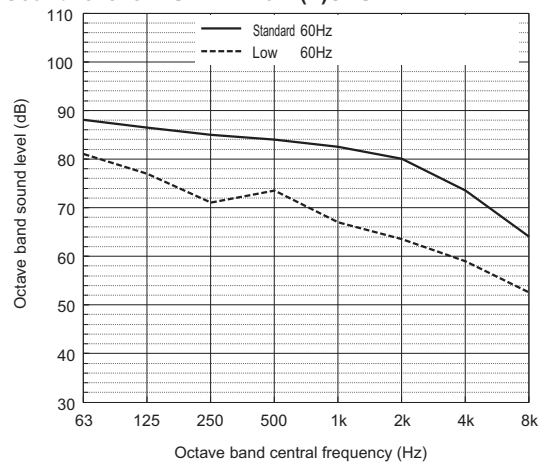

		63	125	250	500	1k	2k	4k	8k	dB(A)
Standard Heating	60Hz	88.0	86.5	85.0	84.0	82.5	80.0	73.5	64.0	87.0
Low noise mode	60Hz	81.0	77.0	71.0	73.5	67.0	63.5	59.0	52.5	73.5

When Low noise mode is set, the A/C system's capacity is limited. The system could return to normal operation from Low noise mode automatically in the case that the operation condition is severe.

- Depending on the operation conditions, the unit generates noise caused by valve actuation, refrigerant flow, and pressure changes when operating normally. Please consider to avoid location where quietness is required.
For BC controller, it is recommended to be installed in places such as ceilings of corridor, rest rooms and plant rooms.
- The sound values are sound power level (PWL) based on ISO 3744:2010 (r = 3.5 m).

Sound level of PURY-EP288T(Y)SNU

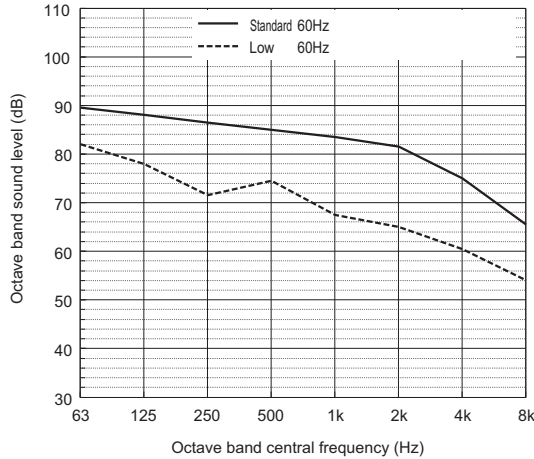

		63	125	250	500	1k	2k	4k	8k	dB(A)
Standard Heating	60Hz	89.5	88.0	86.5	85.0	83.5	81.5	75.0	65.5	88.5
Low noise mode	60Hz	82.0	78.0	71.5	74.5	67.5	65.0	60.5	54.0	74.5

When Low noise mode is set, the A/C system's capacity is limited. The system could return to normal operation from Low noise mode automatically in the case that the operation condition is severe.

Sound level of PURY-EP312T(Y)SNU

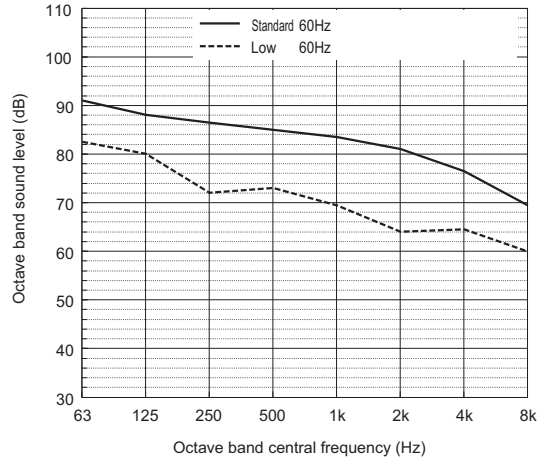

		63	125	250	500	1k	2k	4k	8k	dB(A)
Standard Heating	60Hz	91.0	88.0	86.5	85.0	83.5	81.0	76.5	69.5	88.5
Low noise mode	60Hz	82.5	80.0	72.0	73.0	69.5	64.0	64.5	60.0	75.0

When Low noise mode is set, the A/C system's capacity is limited. The system could return to normal operation from Low noise mode automatically in the case that the operation condition is severe.

Sound level of PURY-EP336T(Y)SNU

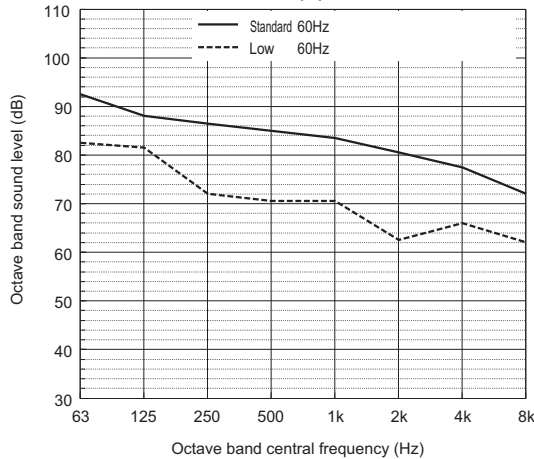

		63	125	250	500	1k	2k	4k	8k	dB(A)
Standard Heating	60Hz	92.5	88.0	86.5	85.0	83.5	80.5	77.5	72.0	88.5
Low noise mode	60Hz	82.5	81.5	72.0	70.5	70.5	62.5	66.0	62.0	75.0

When Low noise mode is set, the A/C system's capacity is limited. The system could return to normal operation from Low noise mode automatically in the case that the operation condition is severe.

Sound level of PURY-EP384T(Y)SNU

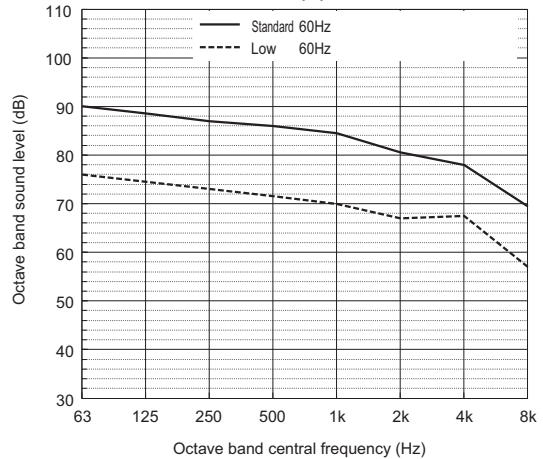

		63	125	250	500	1k	2k	4k	8k	dB(A)
Standard Heating	60Hz	90.0	88.5	87.0	86.0	84.5	80.5	78.0	69.5	89.0
Low noise mode	60Hz	76.0	74.5	73.0	71.5	70.0	67.0	67.5	57.0	75.5

When Low noise mode is set, the A/C system's capacity is limited. The system could return to normal operation from Low noise mode automatically in the case that the operation condition is severe.

Sound level of PURY-EP432T(Y)SNU

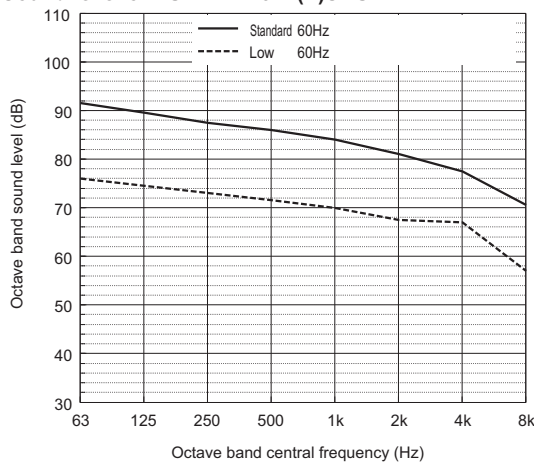

		63	125	250	500	1k	2k	4k	8k	dB(A)
Standard Heating	60Hz	91.5	89.5	87.5	86.0	84.0	81.0	77.5	70.5	89.0
Low noise mode	60Hz	76.0	74.5	73.0	71.5	70.0	67.5	67.0	57.0	75.5

When Low noise mode is set, the A/C system's capacity is limited. The system could return to normal operation from Low noise mode automatically in the case that the operation condition is severe.

- Depending on the operation conditions, the unit generates noise caused by valve actuation, refrigerant flow, and pressure changes when operating normally. Please consider to avoid location where quietness is required.
- For BC controller, it is recommended to be installed in places such as ceilings of corridor, rest rooms and plant rooms.
- The sound values are sound power level (PWL) based on ISO 3744:2010 (r = 3.5 m).

[PURY-EP72-240T/YNU, PURY-EP192-432T/YSNU]

Measurement condition

Measurement frequency: 1 Hz-80 Hz

Measurement point: Ground surface 20 cm away from the unit leg

Installation condition: Direct installation on the concrete floor

Power source: 3-phase 3-wire 208 V-230 V 60 Hz: For TNU-Series

3-phase 3-wire 460 V 60 Hz: For YNU-Series

Operation condition: JIS condition (cooling, heating)

Measurement device: Vibration level meter for vibration pollution VM-1220C (JIS-compliant product)

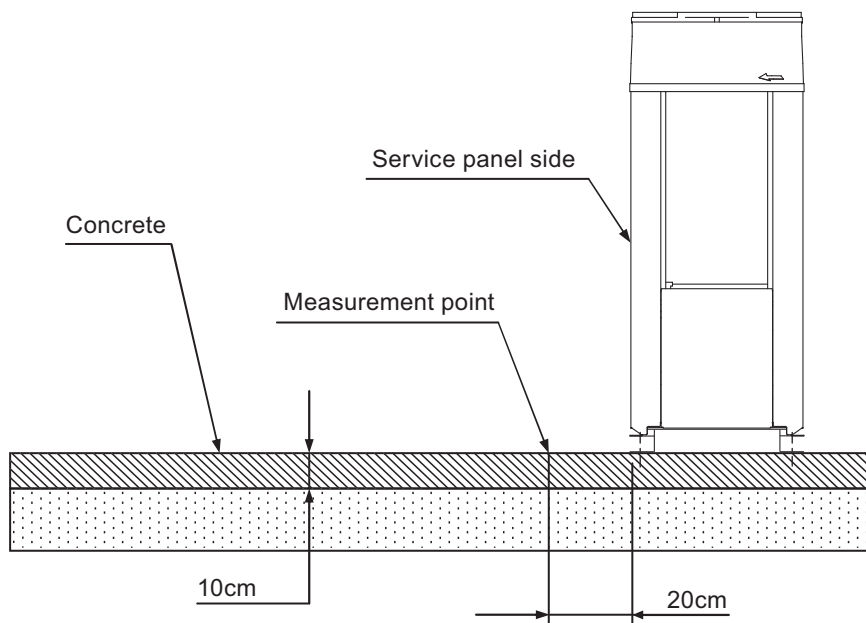

Vibration level

Model	Vibration level (dB)
PURY-EP72T(Y)NU-A (-BS)	45
PURY-EP96T(Y)NU-A (-BS)	46
PURY-EP120T(Y)NU-A (-BS)	47
PURY-EP144T(Y)NU-A (-BS)	47
PURY-EP168T(Y)NU-A (-BS)	48
PURY-EP192T(Y)NU-A (-BS)	48
PURY-EP216T(Y)NU-A (-BS)	48.5
PURY-EP240T(Y)NU-A (-BS)	49
PURY-EP192T(Y)SNU-A (-BS)	49
PURY-EP216T(Y)SNU-A (-BS)	49.5
PURY-EP240T(Y)SNU-A (-BS)	50
PURY-EP264T(Y)SNU-A (-BS)	50
PURY-EP288T(Y)SNU-A (-BS)	50
PURY-EP312T(Y)SNU-A (-BS)	50.5
PURY-EP336T(Y)SNU-A (-BS)	51
PURY-EP384T(Y)SNU-A (-BS)	51
PURY-EP432T(Y)SNU-A (-BS)	51.5

* Vibration level varies depending on the conditions of actual installation site.

• Cooling

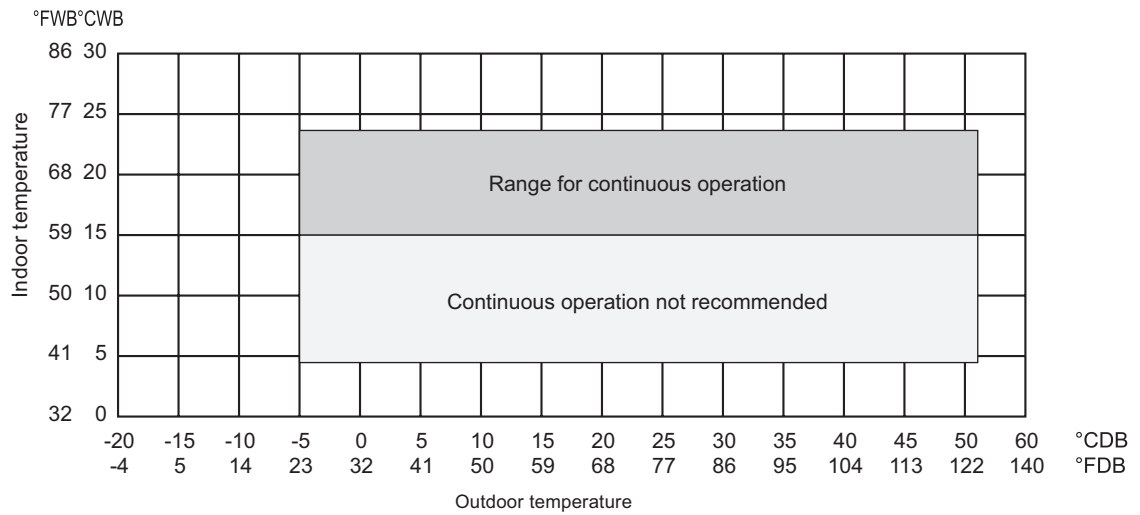

* The operation temperature of outdoor unit is limited into 32~109°FDB (0~43°CDB) when the outdoor unit is installed in a location that is positioned lower than the indoor units.

• Heating

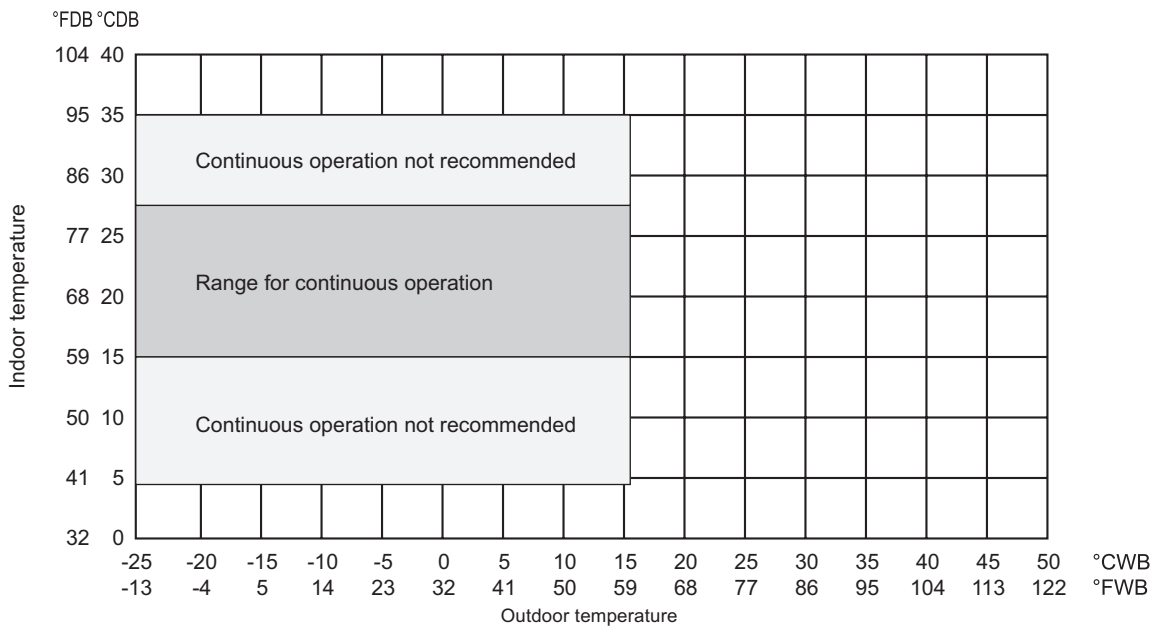

• Combination of cooling/heating operation (Cooling main or Heating main)

Outdoor temperature	Indoor temperature	
	Cooling	Heating
14 to 70°FDB (-10 to 21°CDB)	—	59 to 81°FDB (15 to 27°CDB)
12 to 60°FWB (-11 to 15.5°CWB)	59 to 75°FWB (15 to 24°CWB)	—

Installation of the low ambient kit is recommended to operate in cooling and cooling main mode in conditions under 50°F [10°C].

8-1. Selection of Cooling/Heating Units

How to determine the capacity when less than or equal 100% indoor model size units are connected in total:

The purpose of this flow chart is to select the indoor and outdoor units. For other purposes, this flow chart is intended only for reference.

PURY-EP-T(S)NU-A, Y(S)NU-A

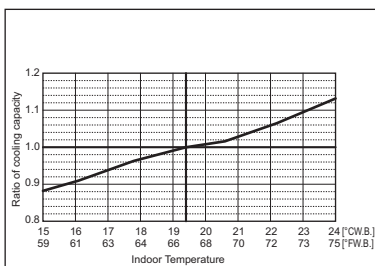
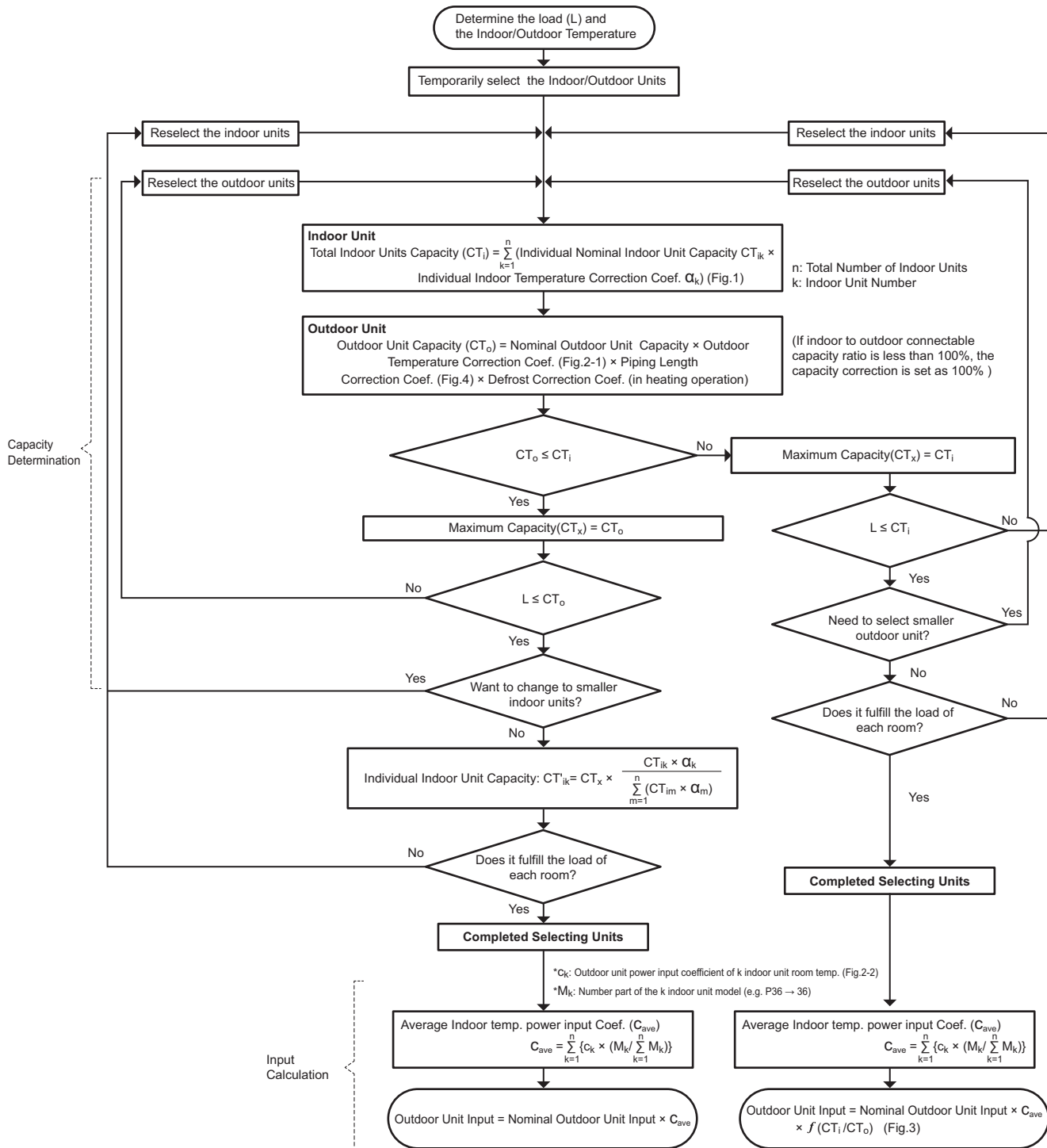

Fig.1 Indoor unit temperature correction

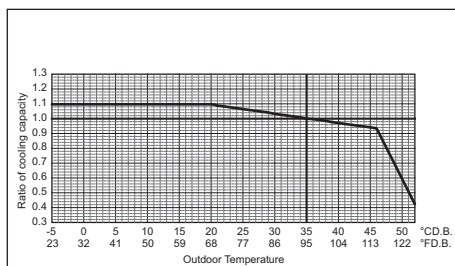

Fig.2-1 Outdoor unit temperature correction (capacity)

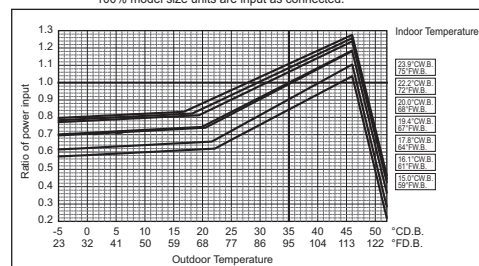
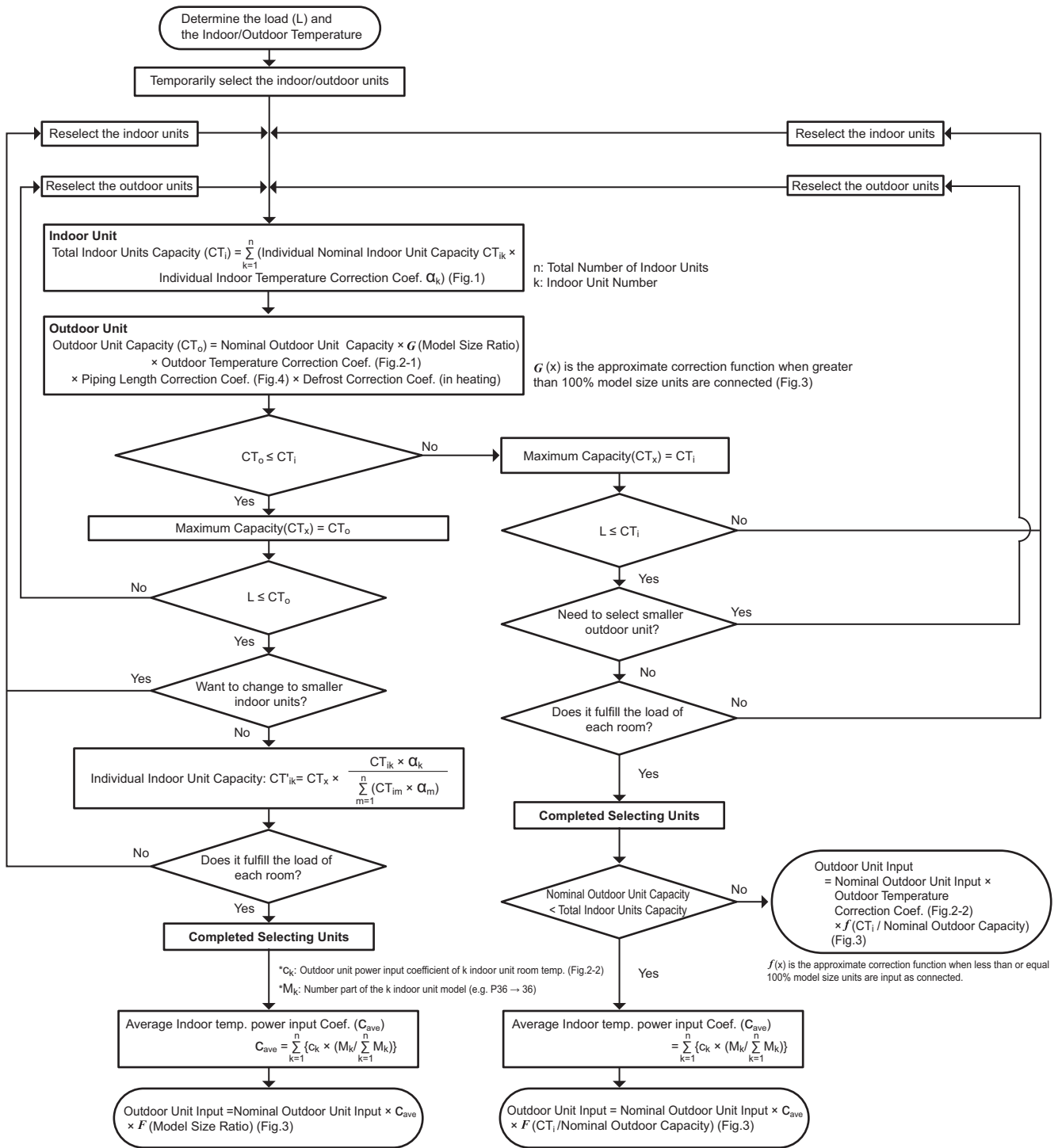

Fig.2-2 Outdoor unit temperature correction (power input)

How to determine the capacity when greater than 100% indoor model size units are connected in total:

The purpose of this flow chart is to select the indoor and outdoor units. For other purposes, this flow chart is intended only for reference.



F(x) is the approximate correction function when greater than 100% model size units are input as connected.

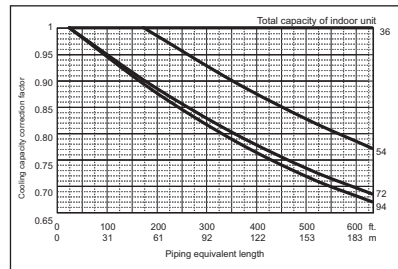
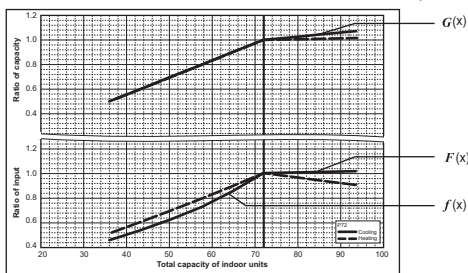

<Cooling>

Design Condition	
Outdoor Design Dry Bulb Temperature	37 °C
Total Cooling Load	18.5 kW
Room1	
Indoor Design Dry Bulb Temperature	27 °C
Indoor Design Wet Bulb Temperature	20 °C
Cooling Load	9.0 kW
Room2	
Indoor Design Dry Bulb Temperature	24 °C
Indoor Design Wet Bulb Temperature	17.8 °C
Cooling Load	9.5 kW
<Other>	
Indoor/Outdoor Equivalent Piping Length	30 m

1. Cooling Calculation

(1) Temporary Selection of Indoor Units

Room1	
PEFY-P36	10.6 kW (Nominal)
Room2	
PEFY-P36	10.6 kW (Nominal)

(2) Total Indoor Units Capacity

$P36 + P36 = P72$

(3) Selection of Outdoor Unit

The P72 outdoor unit is selected as total indoor units capacity is P72

PUHY-P72	21.1 kW
----------	---------

(4) Total Indoor Units Capacity Correction Calculation

Room1	
Indoor Design Wet Bulb Temperature Correction (20°C)	1.02 (Refer to Fig.1)
Room2	
Indoor Design Wet Bulb Temperature Correction (18°C)	0.96 (Refer to Fig.1)

Total Indoor Units Capacity (CTi)

$$CTi = \sum (\text{Indoor Unit Rating} \times \text{Indoor Design Temperature Correction})$$

$$= 10.6 \times 1.02 + 10.6 \times 0.96$$

$$= 20.9 \text{ kW}$$

(5) Outdoor Unit Correction Calculation

Outdoor Design Dry Bulb Temperature Correction (37°C)	0.99 (Refer to Fig.2)
Piping Length Correction (30 m)	0.95 (Refer to Fig.3)

Total Outdoor Unit Capacity (CTo)

$$CTo = \text{Outdoor Rating} \times \text{Outdoor Design Temperature Correction} \times \text{Piping Length Correction}$$

$$= 21.1 \times 0.99 \times 0.95$$

$$= 19.8 \text{ kW}$$

(6) Determination of Maximum System Capacity (CTx)

Comparison of Capacity between Total Indoor Units Capacity (CTi) and Total Outdoor Unit Capacity (CTo)

$CTi = 20.9 > CTo = 19.8$, thus, select CTo.

$CTx = CTo = 19.8 \text{ kW}$

(7) Comparison with Essential Load

Against the essential load 18.5kW, the maximum system capacity is 19.8kW: Proper outdoor units have been selected.

(8) Calculation of Maximum Indoor Unit Capacity of Each Room

$CTx = CTo$, thus, calculate by the calculation below

Room1

$$\text{Maximum Capacity} \times \text{Room1 Capacity after the Temperature Correction} / (\text{Room1,2 Total Capacity after the Temperature Correction})$$

$$= 19.8 \times (10.6 \times 1.02) / (10.6 \times 1.02 + 10.6 \times 0.96)$$

$$= 10.2 \text{ kW} \quad \text{OK: fulfills the load 9.0kW}$$

Room2

$$\text{Maximum Capacity} \times \text{Room2 Capacity after the Temperature Correction} / (\text{Room1,2 Total Capacity after the Temperature Correction})$$

$$= 19.8 \times (10.6 \times 0.96) / (10.6 \times 1.02 + 10.6 \times 0.96)$$

$$= 9.6 \text{ kW} \quad \text{OK: fulfills the load 9.5kW}$$

Go on to the heating trial calculation since the selected units fulfill the cooling loads of Room 1, 2.

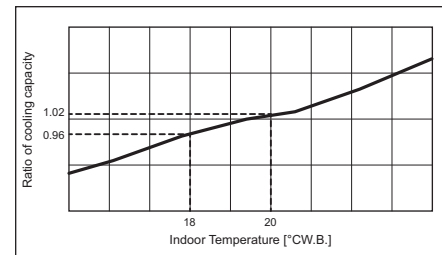

Fig.1 Indoor unit temperature correction
To be used to correct indoor unit only

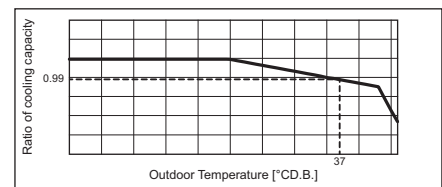

Fig.2 Outdoor unit temperature correction
To be used to correct outdoor unit only

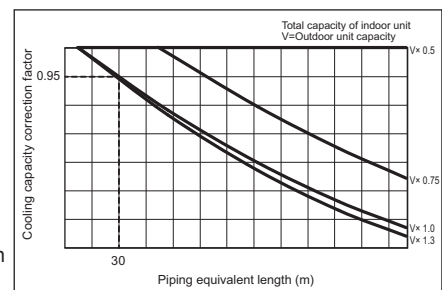

Fig.3 Correction of refrigerant piping length

PURY-EP-T(S)NU-A, Y(S)NU-A

<Heating>

Design Condition	
Outdoor Design Wet Bulb Temperature	2 °C
Total Heating Load	18.2 kW
Room1	
Indoor Design Dry Bulb Temperature	25 °C
Heating Load	9.2 kW
Room2	
Indoor Design Dry Bulb Temperature	25 °C
Heating Load	9.0 kW
<Other>	
Indoor/Outdoor Equivalent Piping Length	30 m

2. Heating Calculation

(1) Temporary Selection of Indoor Units

Room1	PEFY-P36	11.7 kW (Nominal)
Room2	PEFY-P36	11.7 kW (Nominal)

(2) Total Indoor Units Capacity

$P36 + P36 = P72$

(3) Selection of Outdoor Unit

The P72 outdoor unit is selected as total indoor units capacity is P72

PUHY-P72	23.4 kW
----------	---------

(4) Total Indoor Units Capacity Correction Calculation

Room1	Indoor Design Dry Bulb Temperature Correction (25°C)	0.80 (Refer to Fig.4)
Room2	Indoor Design Dry Bulb Temperature Correction (25°C)	0.80 (Refer to Fig.4)

Total Indoor Units Capacity (CTi)

$$CTi = \sum (\text{Indoor Unit Rating} \times \text{Indoor Design Temperature Correction})$$

$$= 11.7 \times 0.80 + 11.7 \times 0.80$$

$$= 18.7 \text{ kW}$$

(5) Outdoor Unit Correction Calculation

Outdoor Design Wet Bulb Temperature Correction (2°C)	0.98 (Refer to Fig.5)
Piping Length Correction (30 m)	0.98 (Refer to Fig.6)
Defrost Correction	0.84 (Refer to Tbl.1)

Total Outdoor Unit Capacity (CTo)

$$CTo = \text{Outdoor Unit Rating} \times \text{Outdoor Design Temperature Correction} \times \text{Piping Length Correction} \times \text{Defrost Correction}$$

$$= 23.4 \times 0.98 \times 0.98 \times 0.84$$

$$= 18.8 \text{ kW}$$

(6) Determination of Maximum System Capacity (CTx)

Comparison of Capacity between Total Indoor Units Capacity (CTi) and Total Outdoor Unit Capacity (CTo)

$CTi = 18.7 < CTo = 18.8$, thus, select CTi.

$CTx = CTi = 18.7 \text{ kW}$

(7) Comparison with Essential Load

Against the essential load 18.2kW, the maximum system capacity is 18.7kW: Proper outdoor units have been selected.

(8) Calculation of Maximum Indoor Unit Capacity of Each Room

$CTx = CTi$, thus, calculate by the calculation below

Room1	Indoor Unit Rating × Indoor Design Temperature Correction	
	$= 11.7 \times 0.80$	
	$= 9.4 \text{ kW}$	OK: fulfills the load 9.2kW

Room2	Indoor Unit Rating × Indoor Design Temperature Correction	
	$= 11.7 \times 0.80$	
	$= 9.4 \text{ kW}$	OK: fulfills the load 9.0kW

Completed selecting units since the selected units fulfill the heating loads of Room 1, 2.

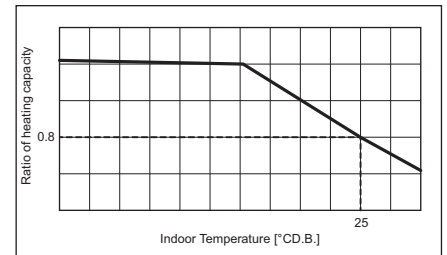

Fig.4 Indoor unit temperature correction
To be used to correct indoor unit only

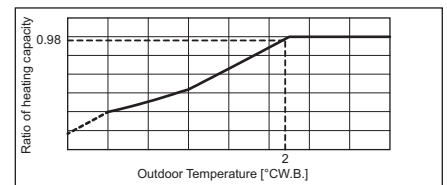

Fig.5 Outdoor unit temperature correction
To be used to correct outdoor unit only

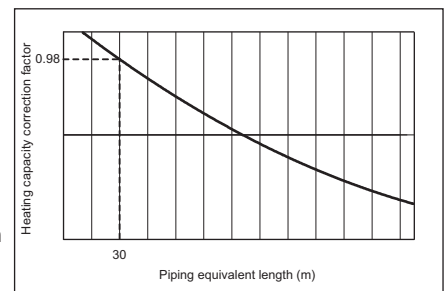

Fig.6 Correction of refrigerant piping length

Tbl.1 Table of correction factor at frost and defrost

Outdoor inlet air temp. °CWB	6	4	2	1	0	-2	-4	-6	-8	-10	-20
Outdoor inlet air temp. °FWB	43	39	36	34	32	28	25	21	18	14	-4
PUHY-P72	1.00	0.95	0.84	0.83	0.83	0.87	0.90	0.95	0.95	0.95	0.95
PUHY-P96	1.00	0.95	0.84	0.83	0.83	0.87	0.90	0.95	0.95	0.95	0.95
PUHY-P120	1.00	0.93	0.82	0.80	0.82	0.86	0.90	0.90	0.95	0.95	0.95
PUHY-P144	1.00	0.93	0.82	0.80	0.82	0.86	0.90	0.90	0.95	0.95	0.95

3. Power input of outdoor unit

<Cooling>

(1) Nominal power input of outdoor unit **4.55 kW (Nominal)****(2) Calculation of the average indoor temperature power input coefficient**

Coefficient of the outdoor unit for indoor unit 1 (Outdoor temp. 37 °CD.B., Indoor temp. 20 °CW.B.)

1.09

Coefficient of the outdoor unit for indoor unit 2 (Outdoor temp. 37 °CD.B., Indoor temp. 17.8 °CW.B.)

1.03

$$\text{Average indoor temp. power input coefficient } (C_{ave}) = \sum_{k=1}^n \{c_k \times (M_k / \sum_{k=1}^n M_k)\}$$

n: Total number of the indoor units

k: Number of the indoor unit

c_k: Outdoor unit power input coefficient of k indoor unit room temp.M_k: Number part of the k indoor unit model (e.g. P36 → 36)

$$= 1.09 \times 36 / (36 + 36) + 1.03 \times 36 / (36 + 36)$$

$$= 1.06$$

(3) No need to consider Coefficient of the partial load f(CTi/CTo) -**(4) Outdoor power input (P_{lo})**Maximum System Capacity (CT_x) = Total Outdoor unit Capacity (CT_o), so use the following formulaP_{lo} = Outdoor unit Cooling Nominal Power Input × Correction Coefficient of Indoor temperature

$$= 4.55 \times 1.06$$

$$= 4.82 \text{ kW}$$

<Heating>

(1) Nominal power input of outdoor unit **5.48 kW (Nominal)****(2) Calculation of the average indoor temperature power input coefficient**Coefficient of the outdoor unit for indoor unit 1 (Outdoor temp. 2 °CW.B., Indoor temp. 25 °CD.B.)
0.80Coefficient of the outdoor unit for indoor unit 2 (Outdoor temp. 2 °CW.B., Indoor temp. 25 °CD.B.)
0.80

$$\text{Average indoor temp. power input coefficient (C}_{ave}\text{)} = \sum_{k=1}^n \{c_k \times (M_k / \sum_{k=1}^n M_k)\}$$

n: Total number of the indoor units

k: Number of the indoor unit

c_k: Outdoor unit power input coefficient of k indoor unit room temp.M_k: Number part of the k indoor unit model (e.g. P36 → 36)

$$= 0.8 \times 36 / (36 + 36) + 0.8 \times 36 / (36 + 36)$$

$$= 0.80$$

(3) Coefficient of the partial load f (CTi/CTo) **0.94****(4) Outdoor power input (P_{lo})**Maximum System Capacity (CT_x) = Total Indoor unit Capacity (CT_i), so use the following formula

$$P_{lo} = \text{Outdoor unit Heating Nominal Power Input} \times \text{Correction Coefficient of Indoor temperature} \times f \text{ (CT}_i\text{/CT}_o\text{)}$$

$$= 5.48 \times 0.8 \times 0.94$$

$$= 4.12 \text{ kW}$$

<Cooling>

Design Condition	
Outdoor Design Dry Bulb Temperature	99 °F
Total Cooling Load	63,000 BTU/h
Room1	
Indoor Design Dry Bulb Temperature	81 °F
Indoor Design Wet Bulb Temperature	68 °F
Cooling Load	31,000 BTU/h
Room2	
Indoor Design Dry Bulb Temperature	75 °F
Indoor Design Wet Bulb Temperature	64 °F
Cooling Load	32,000 BTU/h
<Other>	
Indoor/Outdoor Equivalent Piping Length	100 ft.

1. Cooling Calculation

(1) Temporary Selection of Indoor Units

Room1	PEFY-P36	36,000 BTU/h (Nominal)
Room2	PEFY-P36	36,000 BTU/h (Nominal)

(2) Total Indoor Units Capacity

$P36 + P36 = P72$

(3) Selection of Outdoor Unit

The P72 outdoor unit is selected as total indoor units capacity is P72

PUHY-P72	72,000 BTU/h
----------	--------------

(4) Total Indoor Units Capacity Correction Calculation

Room1	Indoor Design Wet Bulb Temperature Correction (68°F)	1.02 (Refer to Fig.1)
Room2	Indoor Design Wet Bulb Temperature Correction (64°F)	0.96 (Refer to Fig.1)

Total Indoor Units Capacity (CTi)

$$CTi = \sum (\text{Indoor Unit Rating} \times \text{Indoor Design Temperature Correction})$$

$$= 36,000 \times 1.02 + 36,000 \times 0.96$$

$$= 71,200 \text{ BTU/h}$$

(5) Outdoor Unit Correction Calculation

Outdoor Design Dry Bulb Temperature Correction (99°F)	0.99 (Refer to Fig.2)
Piping Length Correction (100 ft.)	0.95 (Refer to Fig.3)

Total Outdoor Unit Capacity (CTo)

$$CTo = \text{Outdoor Rating} \times \text{Outdoor Design Temperature Correction} \times \text{Piping Length Correction}$$

$$= 72,000 \times 0.99 \times 0.95$$

$$= 67,700 \text{ BTU/h}$$

(6) Determination of Maximum System Capacity (CTx)

Comparison of Capacity between Total Indoor Units Capacity (CTi) and Total Outdoor Unit Capacity (CTo)

$CTi = 71,200 > CTo = 67,700$, thus, select CTo.

$CTx = CTo = 67,700 \text{ BTU/h}$

(7) Comparison with Essential Load

Against the essential load 63,000BTU/h, the maximum system capacity is 67,700BTU/h: Proper outdoor units have been selected.

(8) Calculation of Maximum Indoor Unit Capacity of Each Room

$CTx = CTo$, thus, calculate by the calculation below

Room1

$$\text{Maximum Capacity} \times \text{Room1 Capacity after the Temperature Correction} / (\text{Room1,2 Total Capacity after the Temperature Correction})$$

$$= 67,700 \times (36,000 \times 1.02) / (36,000 \times 1.02 + 36,000 \times 0.96)$$

$$= 34,800 \text{ BTU/h} \quad \text{OK: fulfills the load 31,000BTU/h}$$

Room2

$$\text{Maximum Capacity} \times \text{Room2 Capacity after the Temperature Correction} / (\text{Room1,2 Total Capacity after the Temperature Correction})$$

$$= 67,700 \times (36,000 \times 0.96) / (36,000 \times 1.02 + 36,000 \times 0.96)$$

$$= 32,800 \text{ BTU/h} \quad \text{OK: fulfills the load 32,000BTU/h}$$

Go on to the heating trial calculation since the selected units fulfill the cooling loads of Room 1, 2.

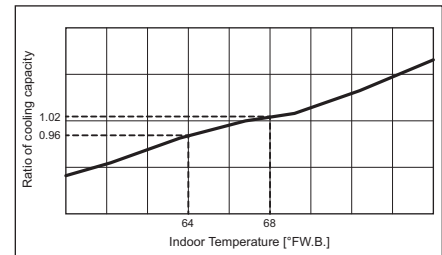

Fig.1 Indoor unit temperature correction
To be used to correct indoor unit only

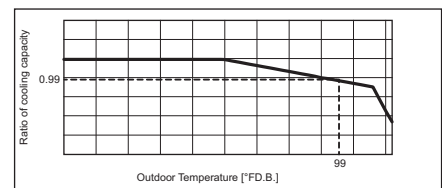

Fig.2 Outdoor unit temperature correction
To be used to correct outdoor unit only

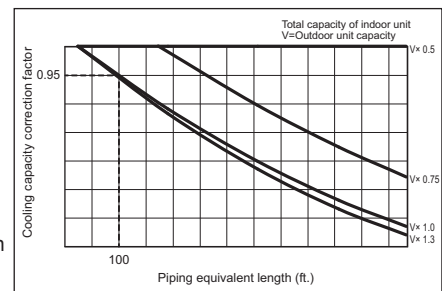

Fig.3 Correction of refrigerant piping length

<Heating>

Design Condition	
Outdoor Design Wet Bulb Temperature	37 °F
Total Heating Load	62,000 BTU/h
Room1	
Indoor Design Dry Bulb Temperature	77 °F
Heating Load	31,000 BTU/h
Room2	
Indoor Design Dry Bulb Temperature	77 °F
Heating Load	31,000 BTU/h
<Other>	
Indoor/Outdoor Equivalent Piping Length	100 ft.

2. Heating Calculation

(1) Temporary Selection of Indoor Units

Room1	PEFY-P36	40,000 BTU/h (Nominal)
Room2	PEFY-P36	40,000 BTU/h (Nominal)

(2) Total Indoor Units Capacity

$P36 + P36 = P72$

(3) Selection of Outdoor Unit

The P72 outdoor unit is selected as total indoor units capacity is P72

PUHY-P72	80,000 BTU/h
----------	--------------

(4) Total Indoor Units Capacity Correction Calculation

Room1	Indoor Design Dry Bulb Temperature Correction (77°F)	0.80 (Refer to Fig.4)
Room2	Indoor Design Dry Bulb Temperature Correction (77°F)	0.80 (Refer to Fig.4)

Total Indoor Units Capacity (CTi)

$$CTi = \sum (\text{Indoor Unit Rating} \times \text{Indoor Design Temperature Correction})$$

$$= 40,000 \times 0.80 + 40,000 \times 0.80$$

$$= 64,000 \text{ BTU/h}$$

(5) Outdoor Unit Correction Calculation

Outdoor Design Wet Bulb Temperature Correction (37°F)	0.99 (Refer to Fig.5)
Piping Length Correction (100 ft.)	0.98 (Refer to Fig.6)
Defrost Correction	0.87 (Refer to Tbl.1)

Total Outdoor Unit Capacity (CTo)

$$CTo = \text{Outdoor Unit Rating} \times \text{Outdoor Design Temperature Correction} \times \text{Piping Length Correction} \times \text{Defrost Correction}$$

$$= 80,000 \times 0.99 \times 0.98 \times 0.87$$

$$= 67,000 \text{ BTU/h}$$

(6) Determination of Maximum System Capacity (CTx)

Comparison of Capacity between Total Indoor Units Capacity (CTi) and Total Outdoor Unit Capacity (CTo)

$CTi = 64,000 < CTo = 67,000$, thus, select CTi.

$CTx = CTi = 64,000 \text{ BTU/h}$

(7) Comparison with Essential Load

Against the essential load 62,000BTU/h, the maximum system capacity is 64,000BTU/h: Proper outdoor units have been selected.

(8) Calculation of Maximum Indoor Unit Capacity of Each Room

$CTx = CTi$, thus, calculate by the calculation below

Room1	Indoor Unit Rating × Indoor Design Temperature Correction	= 40,000 × 0.80	= 32,000 BTU/h	OK: fulfills the load 31,000BTU/h
-------	---	-----------------	----------------	--

Room2	Indoor Unit Rating × Indoor Design Temperature Correction	= 40,000 × 0.80	= 32,000 BTU/h	OK: fulfills the load 31,000BTU/h
-------	---	-----------------	----------------	--

Completed selecting units since the selected units fulfill the heating loads of Room 1, 2.

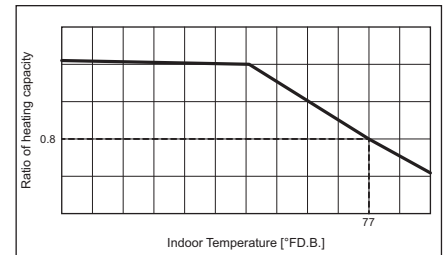

Fig.4 Indoor unit temperature correction
To be used to correct indoor unit only

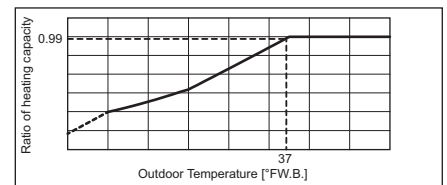

Fig.5 Outdoor unit temperature correction
To be used to correct outdoor unit only

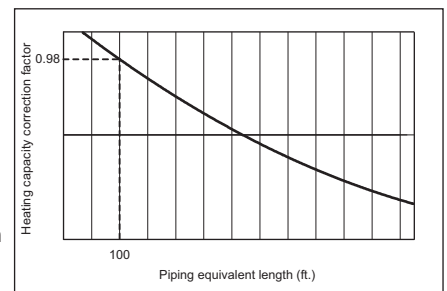

Fig.6 Correction of refrigerant piping length

Tbl.1 Table of correction factor at frost and defrost

Outdoor inlet air temp. °CWB	6	4	2	1	0	-2	-4	-6	-8	-10	-20
Outdoor inlet air temp. °FWB	43	39	36	34	32	28	25	21	18	14	-4
PUHY-P72	1.00	0.95	0.84	0.83	0.83	0.87	0.90	0.95	0.95	0.95	0.95
PUHY-P96	1.00	0.95	0.84	0.83	0.83	0.87	0.90	0.95	0.95	0.95	0.95
PUHY-P120	1.00	0.93	0.82	0.80	0.82	0.86	0.90	0.90	0.95	0.95	0.95
PUHY-P144	1.00	0.93	0.82	0.80	0.82	0.86	0.90	0.90	0.95	0.95	0.95

3. Power input of outdoor unit

<Cooling>

(1) Nominal power input of outdoor unit **4.55 kW (Nominal)****(2) Calculation of the average indoor temperature power input coefficient**

Coefficient of the outdoor unit for indoor unit 1 (Outdoor temp. 99 °FD.B., Indoor temp. 68 °FW.B.)

1.09

Coefficient of the outdoor unit for indoor unit 2 (Outdoor temp. 99 °FD.B., Indoor temp. 64 °FW.B.)

1.03

Average indoor temp. power input coefficient (C_{ave}) = $\sum_{k=1}^n \{c_k \times (M_k / \sum_{k=1}^n M_k)\}$

n: Total number of the indoor units

k: Number of the indoor unit

 c_k : Outdoor unit power input coefficient of k indoor unit room temp. M_k : Number part of the k indoor unit model (e.g. P36 → 36)= $1.09 \times 36 / (36 + 36) + 1.03 \times 36 / (36 + 36)$

= 1.06

(3) No need to consider Coefficient of the partial load $f(CTi/CTo)$ -**(4) Outdoor power input (P_{lo})**Maximum System Capacity (CT_x) = Total Outdoor unit Capacity (CT_o), so use the following formulaP_{lo} = Outdoor unit Cooling Nominal Power Input × Correction Coefficient of Indoor temperature= 4.55×1.06

= 4.82 kW

<Heating>

(1) Nominal power input of outdoor unit **5.48 kW (Nominal)****(2) Calculation of the average indoor temperature power input coefficient**Coefficient of the outdoor unit for indoor unit 1 (Outdoor temp. 35.6 °FW.B., Indoor temp. 77 °FD.B.)
0.80Coefficient of the outdoor unit for indoor unit 2 (Outdoor temp. 35.6 °FW.B., Indoor temp. 77 °FD.B.)
0.80

$$\text{Average indoor temp. power input coefficient } (C_{ave}) = \sum_{k=1}^n \{c_k \times (M_k / \sum_{k=1}^n M_k)\}$$

n: Total number of the indoor units

k: Number of the indoor unit

c_k: Outdoor unit power input coefficient of k indoor unit room temp.M_k: Number part of the k indoor unit model (e.g. P36 → 36)

$$= 0.8 \times 36 / (36 + 36) + 0.8 \times 36 / (36 + 36)$$

$$= 0.80$$

(3) Coefficient of the partial load f (CTi/CTo) **0.92****(4) Outdoor power input (P_{lo})**Maximum System Capacity (CT_x) = Total Indoor unit Capacity (CT_i), so use the following formula

$$P_{lo} = \text{Outdoor unit Heating Nominal Power Input} \times \text{Correction Coefficient of Indoor temperature} \times f \text{ (CTi/CTo)}$$

$$= 5.48 \times 0.8 \times 0.92$$

$$= 4.03 \text{ kW}$$

8-2. Correction by temperature

CITY MULTI could have varied capacity at different designing temperature. Using the nominal cooling/heating capacity value and the ratio below, the capacity can be observed at various temperature.

PURY-EP-T(S)NU-A, Y(S)NU-A

PURY-		EP72TNU/YNU	
		Non-Ducted	Ducted
Nominal cooling capacity	BTU/h	72,000	
	kW	21.1	
	Input kW	4.44	

Indoor unit temperature correction

To be used to correct indoor unit capacity only

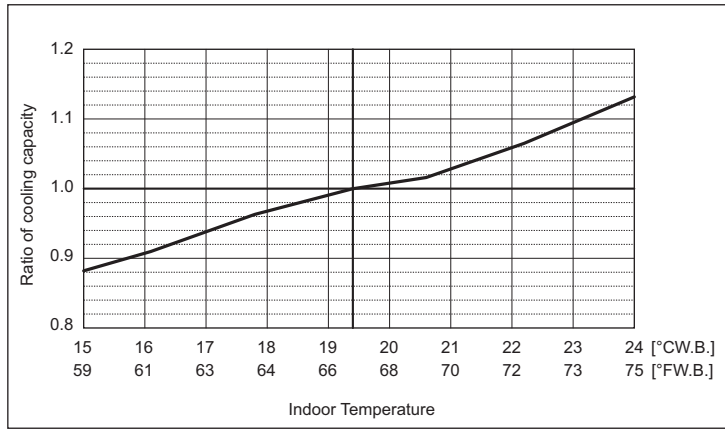

Outdoor unit temperature correction

To be used to correct outdoor unit only

Outdoor unit capacity is NOT affected by the indoor temperature.

Outdoor unit power input is affected by the indoor and outdoor temperatures. Please consult the sales office for details.

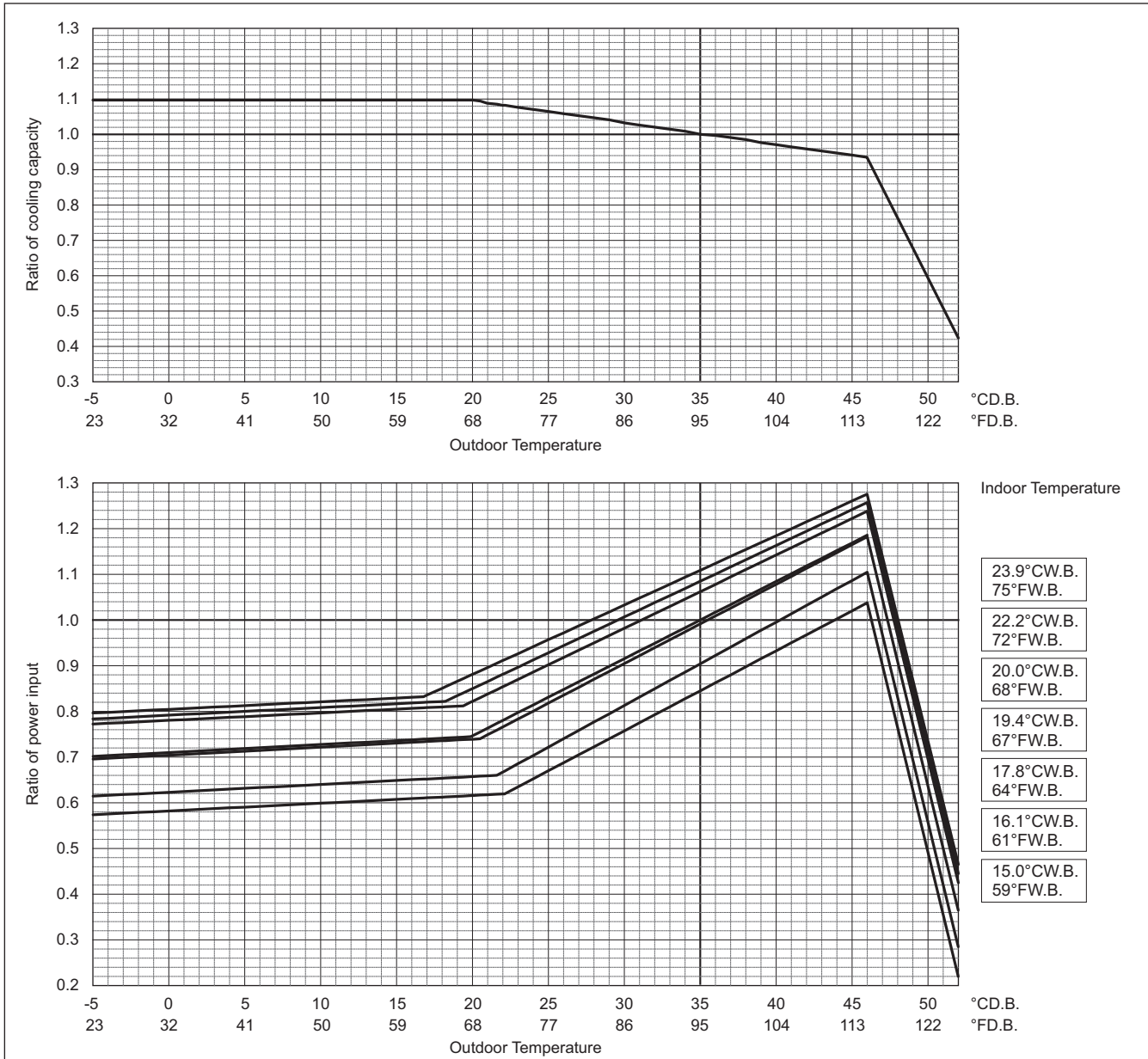

PURY-		EP72TNU/YNU	
		Non-Ducted	Ducted
Nominal Heating capacity	BTU/h	80,000	
	kW	23.4	
	Input kW	5.43	

Indoor unit temperature correction

To be used to correct indoor unit capacity only

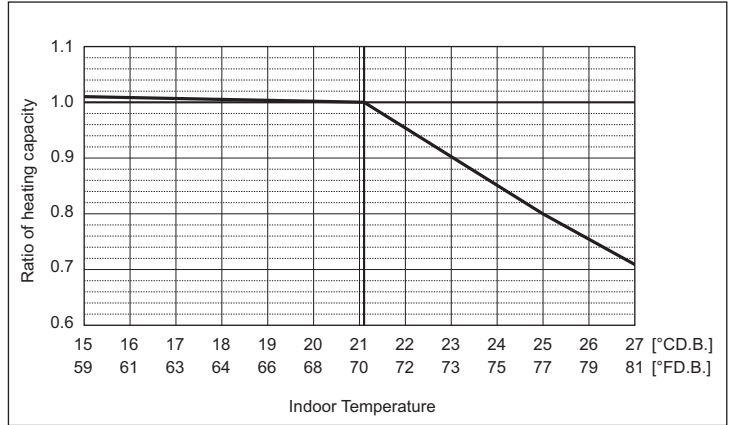

Outdoor unit temperature correction

To be used to correct outdoor unit only

Outdoor unit capacity is NOT affected by the indoor temperature.

Outdoor unit power input is affected by the indoor and outdoor temperatures. Please consult the sales office for details.

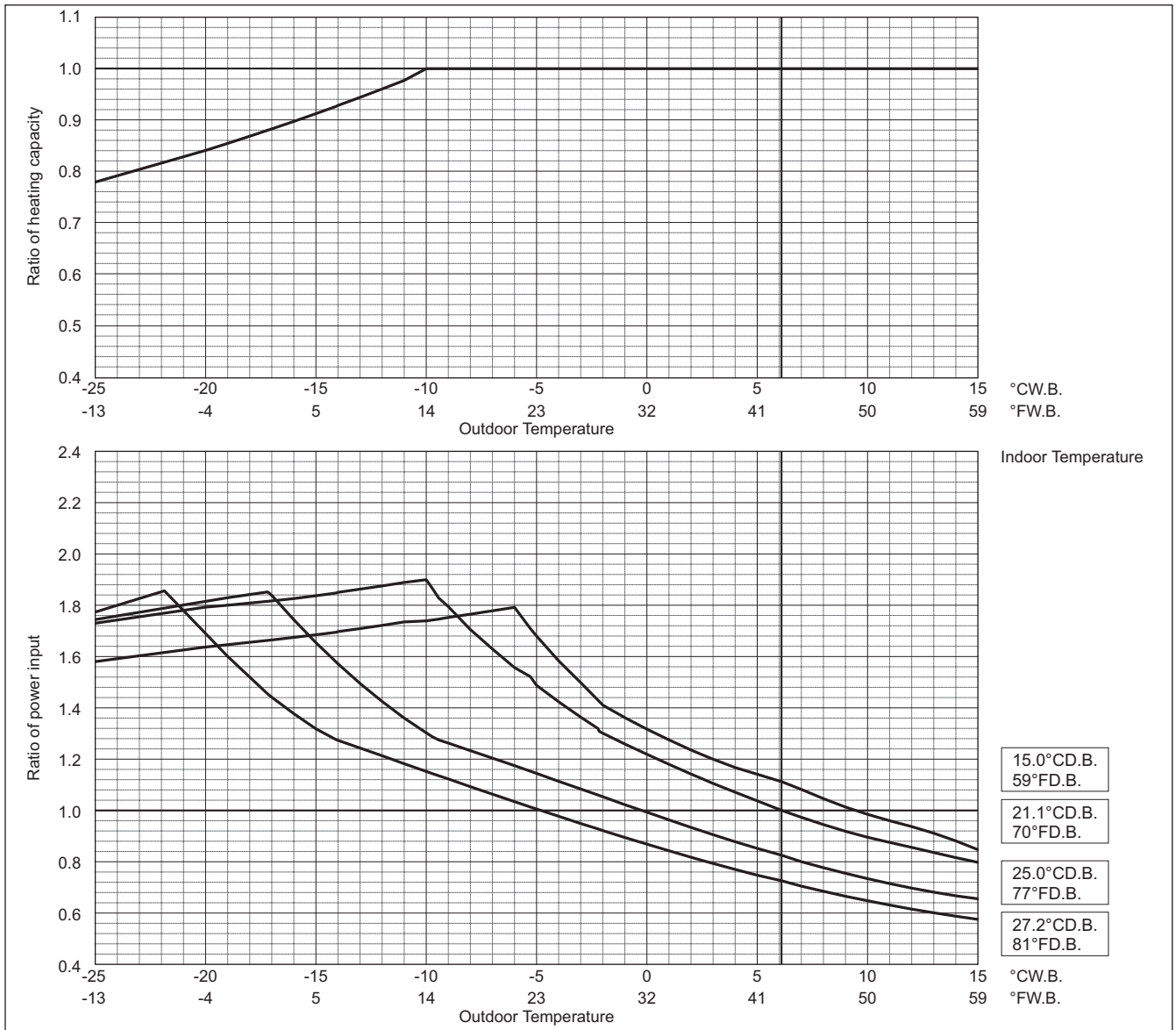

PURY-EP-T(S)NU-A, Y(S)NU-A

PURY-EP-T(S)NU-A, Y(S)NU-A

PURY-		EP96TNU/YNU	
		Non-Ducted	Ducted
Nominal cooling capacity	BTU/h	96,000	
	kW	28.1	
	Input kW	6.11	

Indoor unit temperature correction
To be used to correct indoor unit capacity only

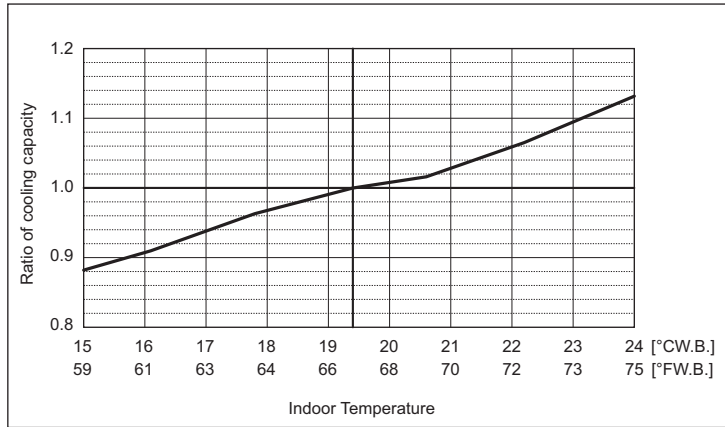

Outdoor unit temperature correction

To be used to correct outdoor unit only

Outdoor unit capacity is NOT affected by the indoor temperature.

Outdoor unit power input is affected by the indoor and outdoor temperatures. Please consult the sales office for details.

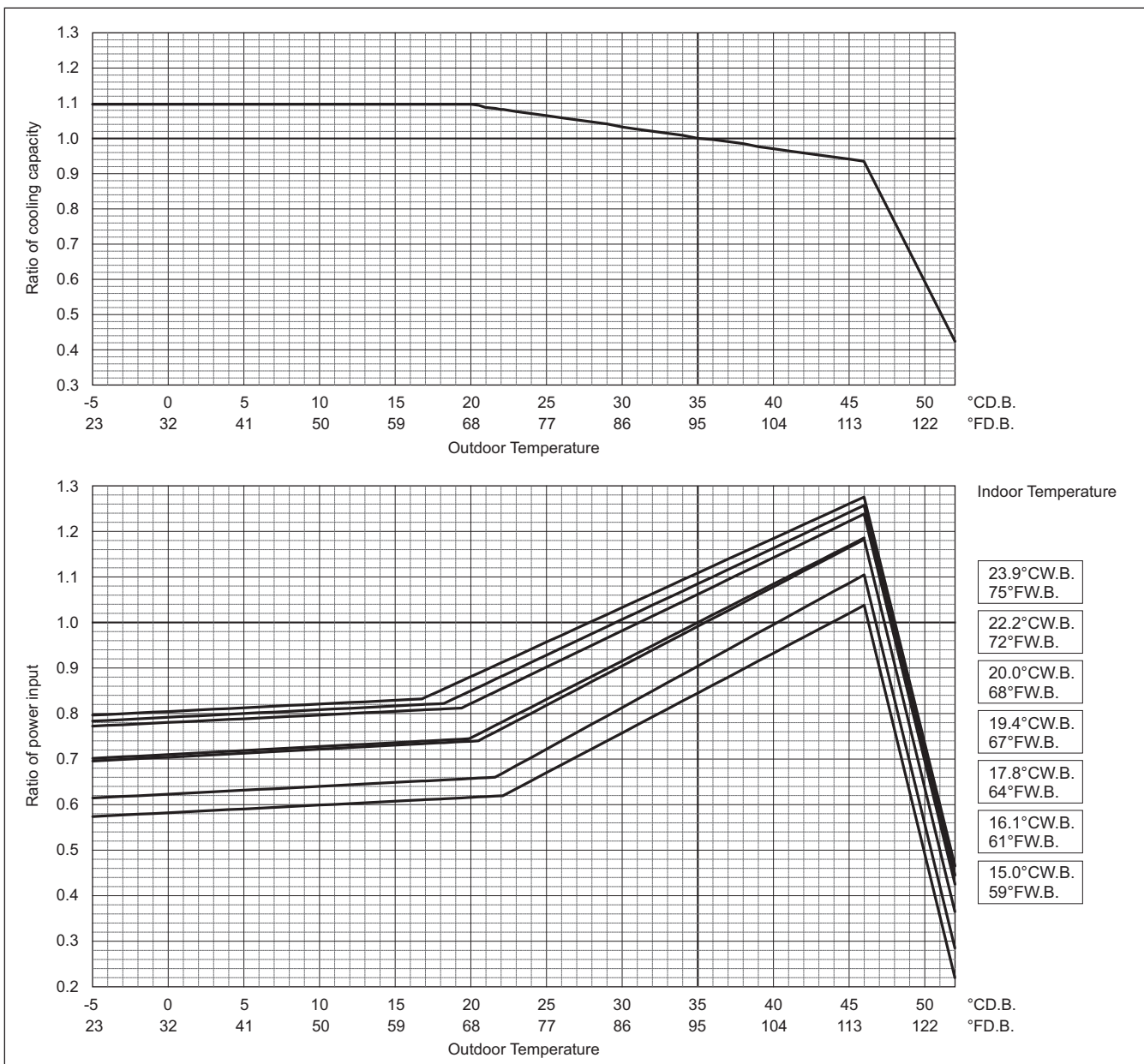

PURY-		EP96TNU/YNU	
		Non-Ducted	Ducted
Nominal Heating capacity	BTU/h	108,000	
	kW	31.7	
	Input kW	7.40	

Indoor unit temperature correction

To be used to correct indoor unit capacity only

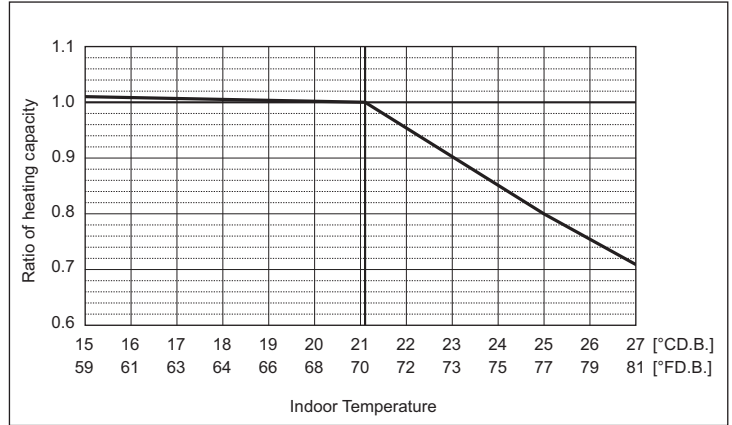

Outdoor unit temperature correction

To be used to correct outdoor unit only

Outdoor unit capacity is NOT affected by the indoor temperature.

Outdoor unit power input is affected by the indoor and outdoor temperatures. Please consult the sales office for details.

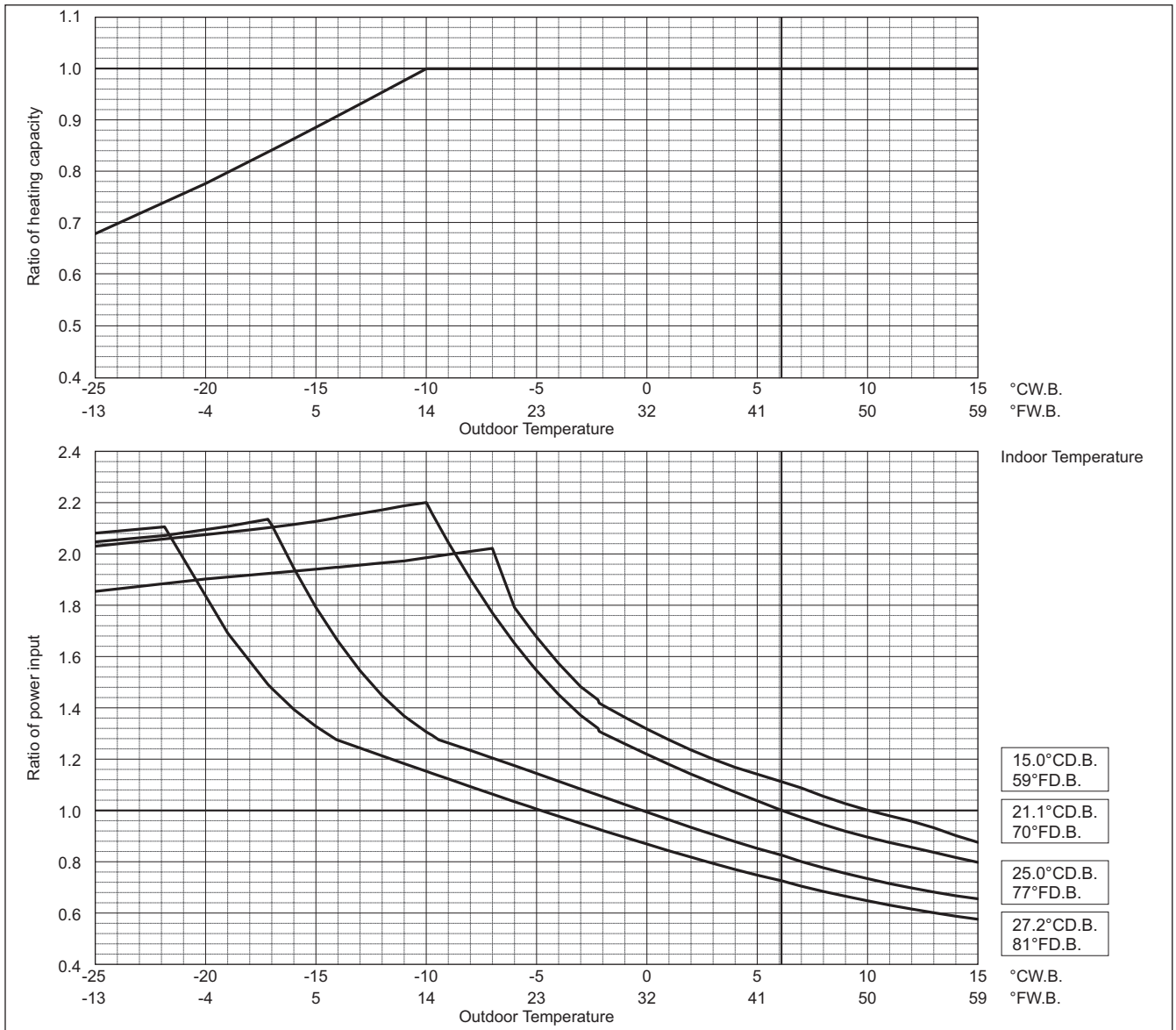

PURY-EP-T(S)NU-A, Y(S)NU-A

PURY-EP-T(S)NU-A, Y(S)NU-A

PURY-		EP120TNU/YNU	
		Non-Ducted	Ducted
Nominal cooling capacity	BTU/h	120,000	
	kW	35.2	
	Input kW	8.43	

Indoor unit temperature correction
To be used to correct indoor unit capacity only

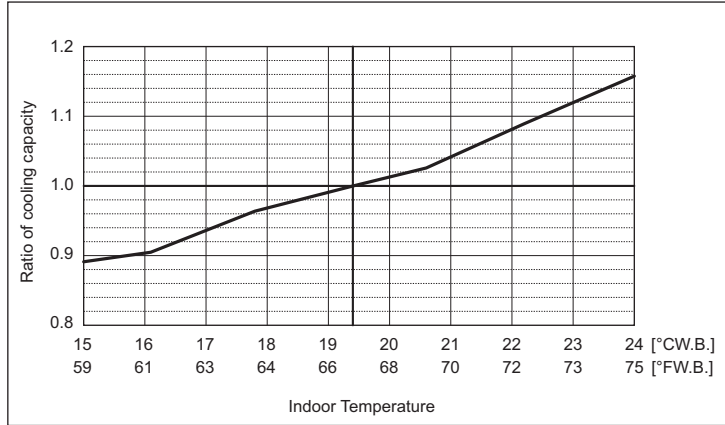

Outdoor unit temperature correction

To be used to correct outdoor unit only
Outdoor unit capacity is NOT affected by the indoor temperature.
Outdoor unit power input is affected by the indoor and outdoor temperatures. Please consult the sales office for details.

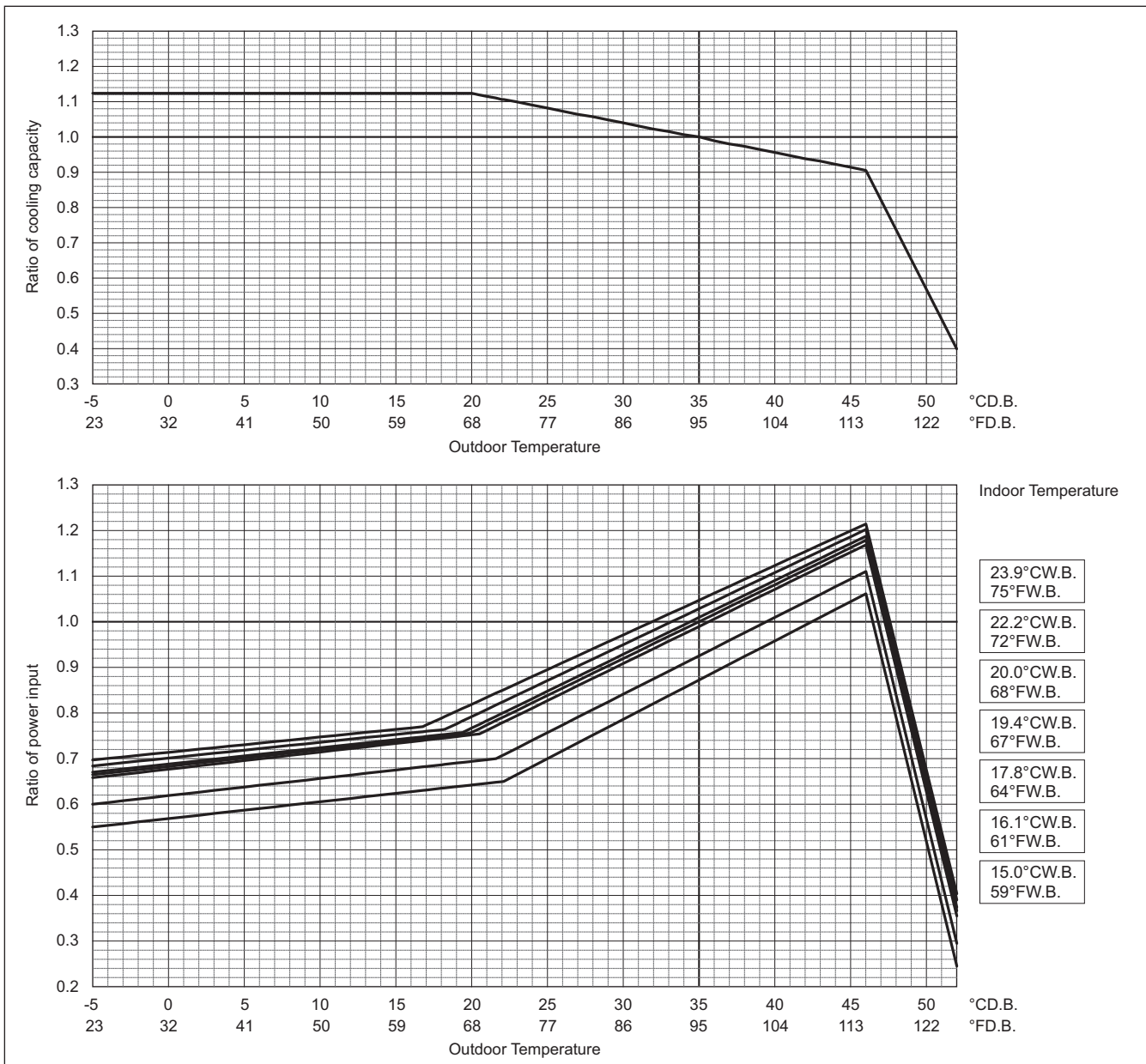

PURY-		EP120TNU/YNU	
		Non-Ducted	Ducted
Nominal Heating capacity	BTU/h	135,000	
	kW	39.6	
	Input kW	9.89	

Indoor unit temperature correction

To be used to correct indoor unit capacity only

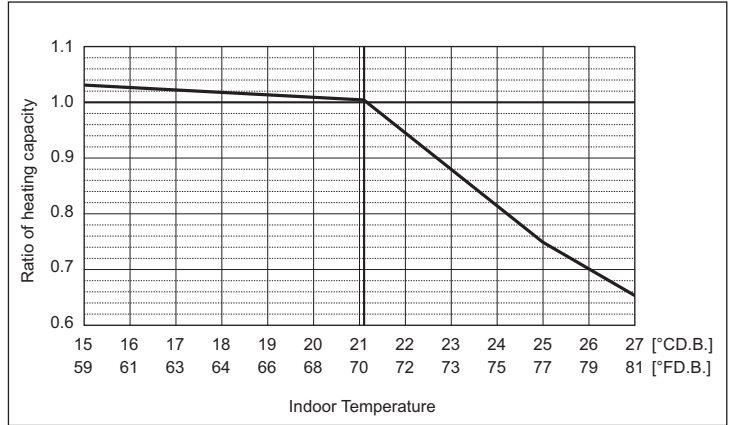

Outdoor unit temperature correction

To be used to correct outdoor unit only

Outdoor unit capacity is NOT affected by the indoor temperature.

Outdoor unit power input is affected by the indoor and outdoor temperatures. Please consult the sales office for details.

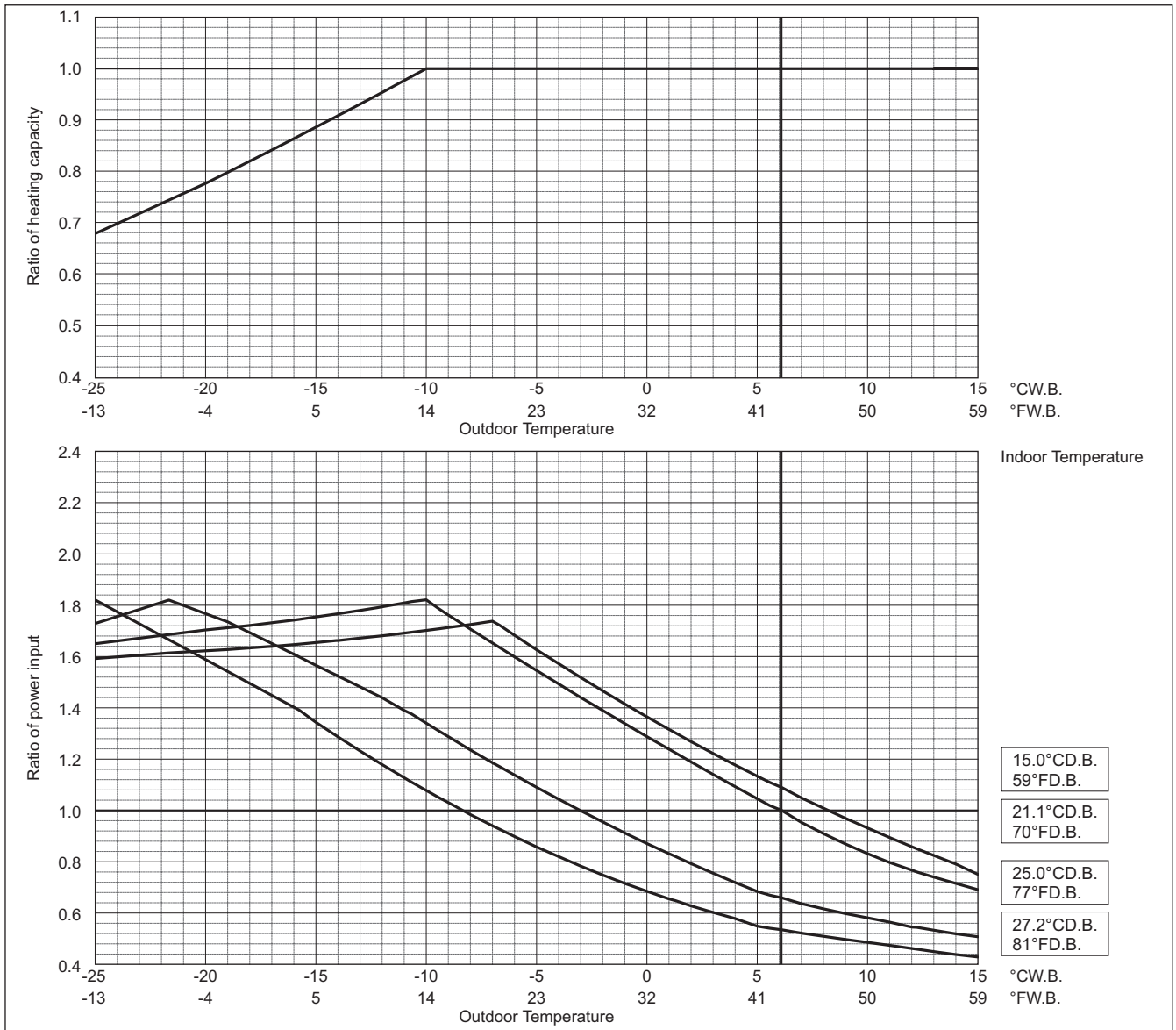

PURY-EP-T(S)NU-A, Y(S)NU-A

PURY-EP-T(S)NU-A, Y(S)NU-A

PURY-		EP144TNU/YNU	
		Non-Ducted	Ducted
Nominal cooling capacity	BTU/h	144,000	
	kW	42.2	
	Input kW	11.03	

Indoor unit temperature correction
To be used to correct indoor unit capacity only

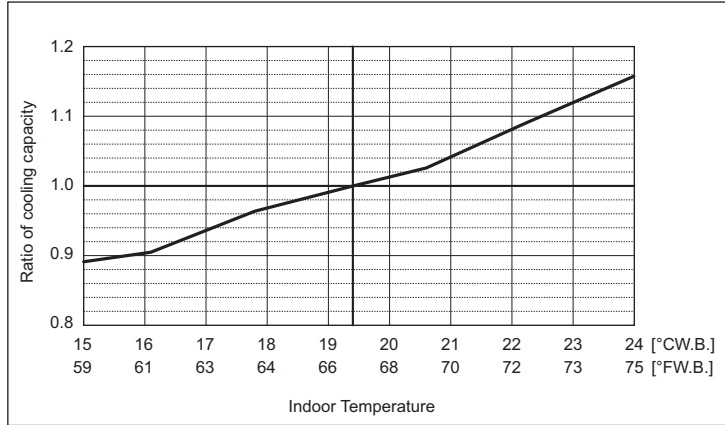

Outdoor unit temperature correction

To be used to correct outdoor unit only
Outdoor unit capacity is NOT affected by the indoor temperature.
Outdoor unit power input is affected by the indoor and outdoor temperatures. Please consult the sales office for details.

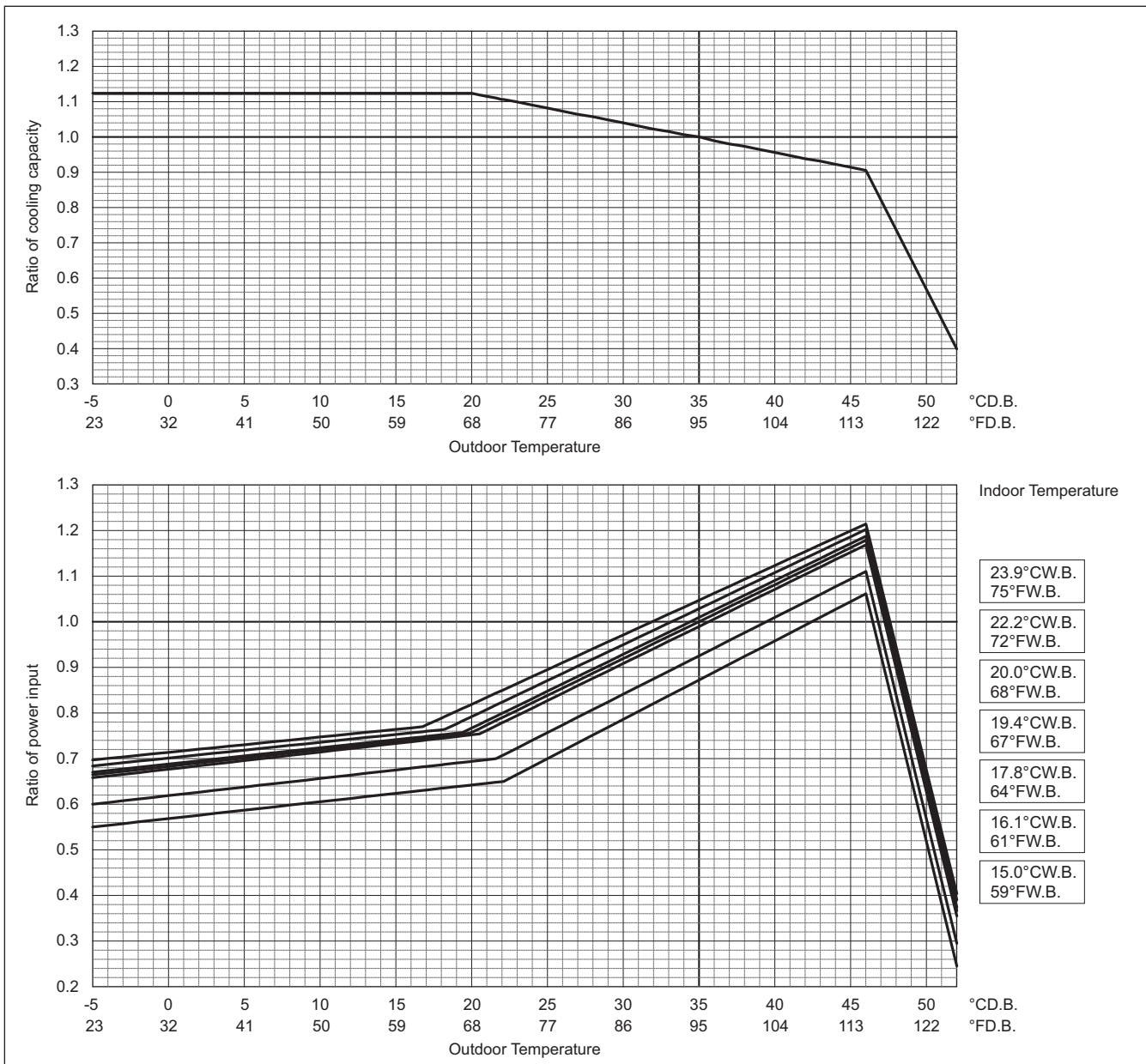

PURY-		EP144TNU/YNU	
		Non-Ducted	Ducted
Nominal Heating capacity	BTU/h	160,000	
	kW	46.9	
	Input kW	12.34	

Indoor unit temperature correction

To be used to correct indoor unit capacity only

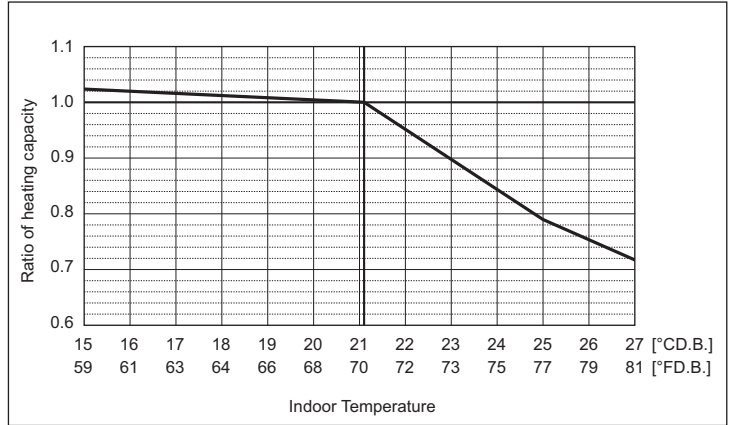

Outdoor unit temperature correction

To be used to correct outdoor unit only

Outdoor unit capacity is NOT affected by the indoor temperature.

Outdoor unit power input is affected by the indoor and outdoor temperatures. Please consult the sales office for details.

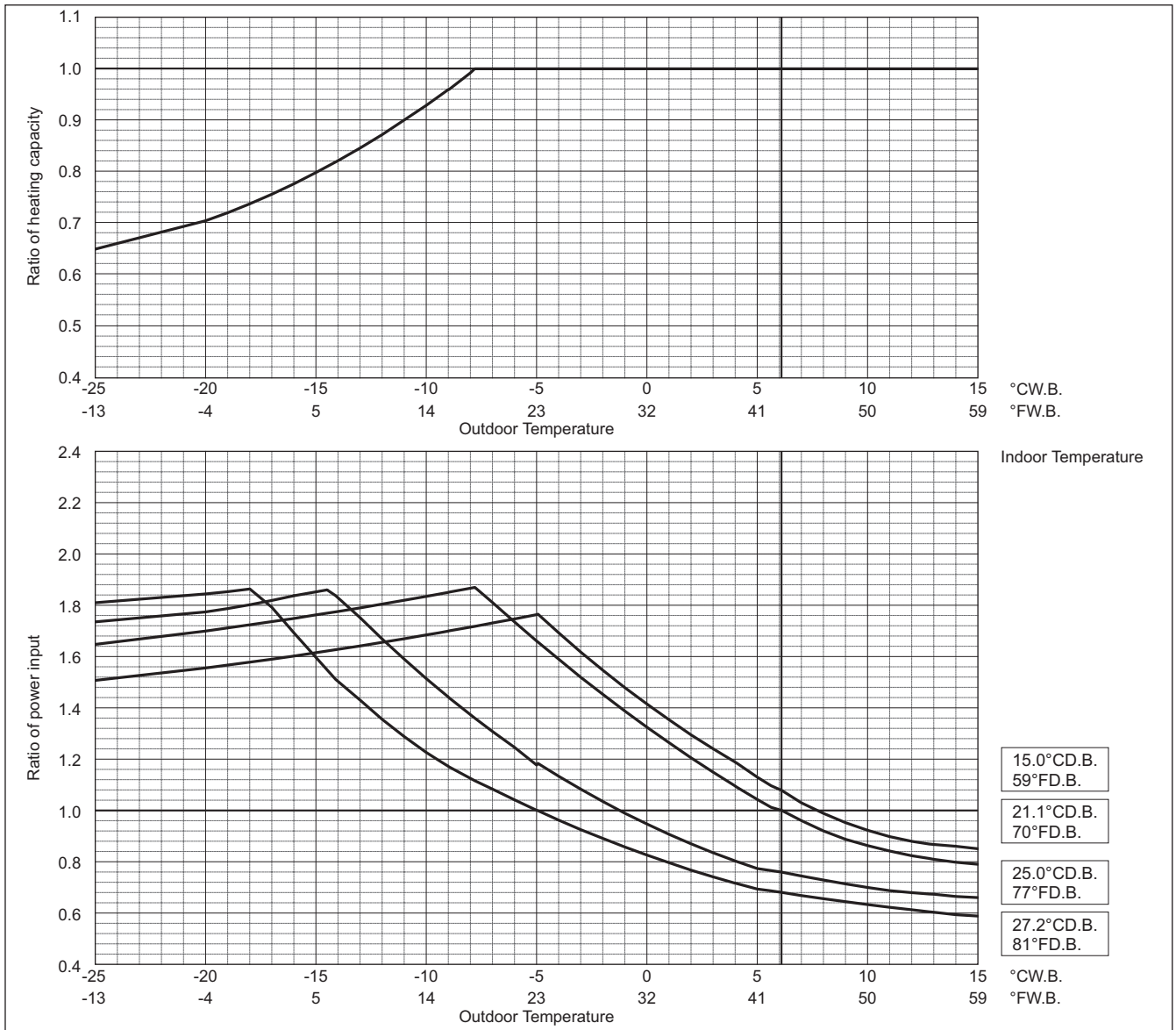

PURY-EP-T(S)NU-A, Y(S)NU-A

PURY-EP-T(S)NU-A, Y(S)NU-A

PURY-		EP168TNU/YNU	
		Non-Ducted	Ducted
Nominal cooling capacity	BTU/h	168,000	
	kW	49.2	
	Input kW	13.99	

Indoor unit temperature correction
To be used to correct indoor unit capacity only

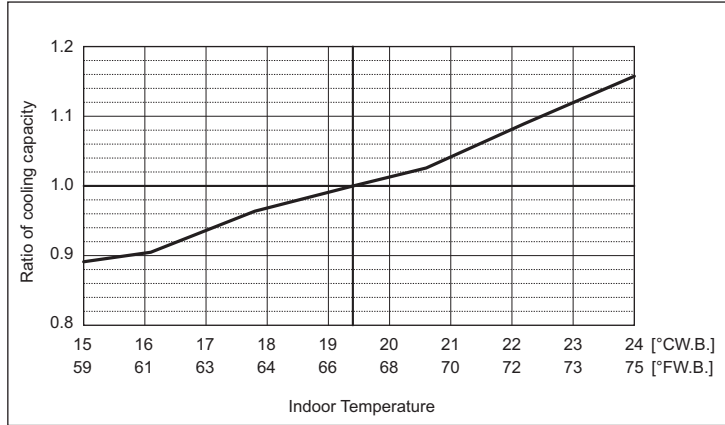

Outdoor unit temperature correction

To be used to correct outdoor unit only
Outdoor unit capacity is NOT affected by the indoor temperature.
Outdoor unit power input is affected by the indoor and outdoor temperatures. Please consult the sales office for details.

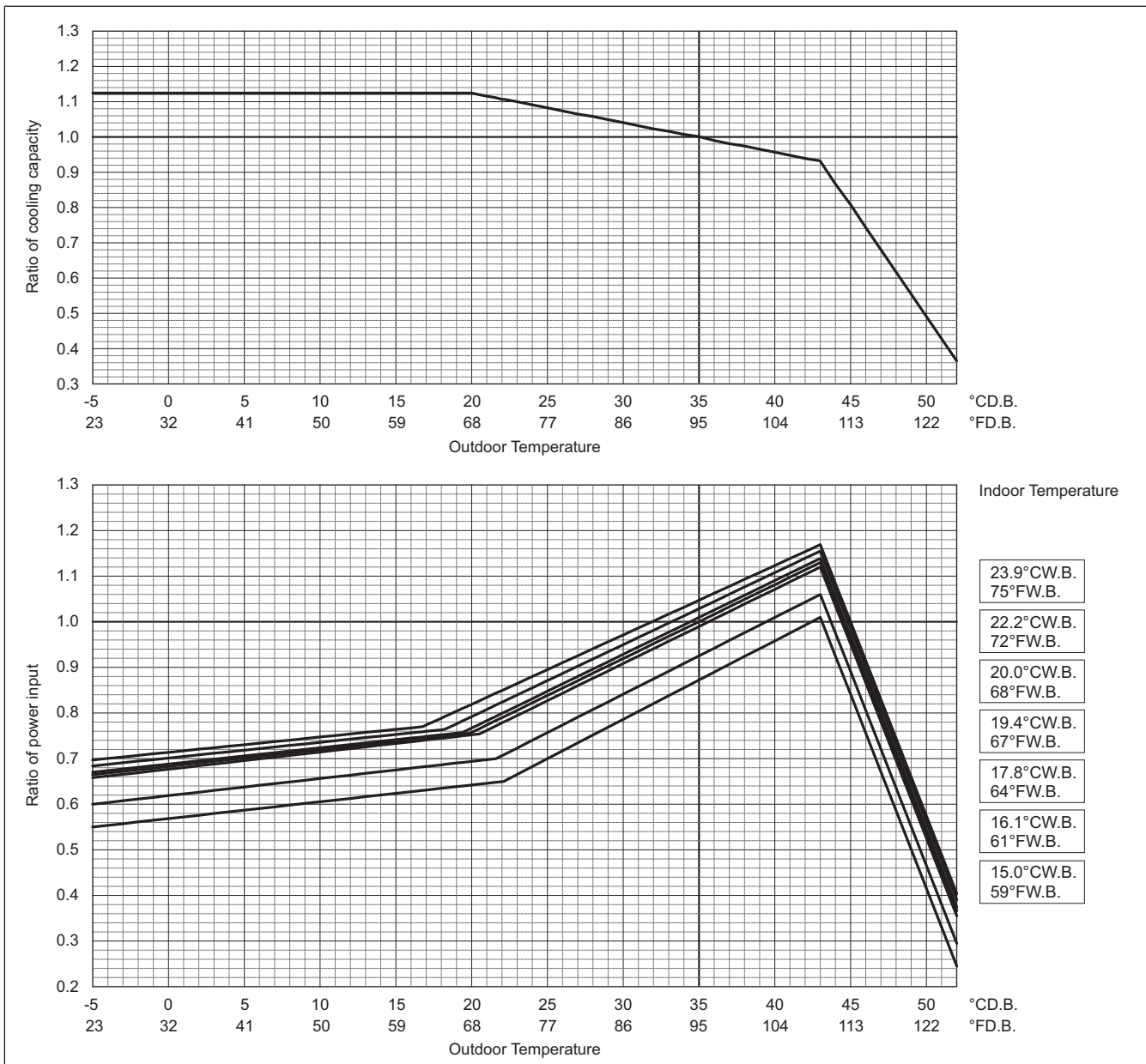

PURY-		EP168TNU/YNU	
		Non-Ducted	Ducted
Nominal Heating capacity	BTU/h	188,000	
	kW	55.1	
	Input kW	15.17	

Indoor unit temperature correction

To be used to correct indoor unit capacity only

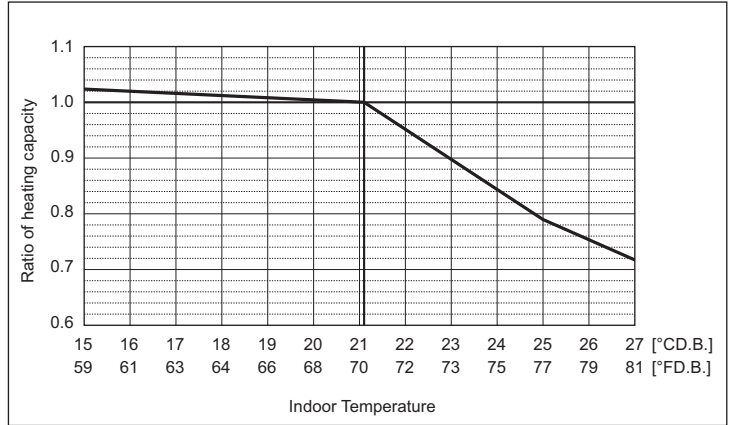

Outdoor unit temperature correction

To be used to correct outdoor unit only

Outdoor unit capacity is NOT affected by the indoor temperature.

Outdoor unit power input is affected by the indoor and outdoor temperatures. Please consult the sales office for details.

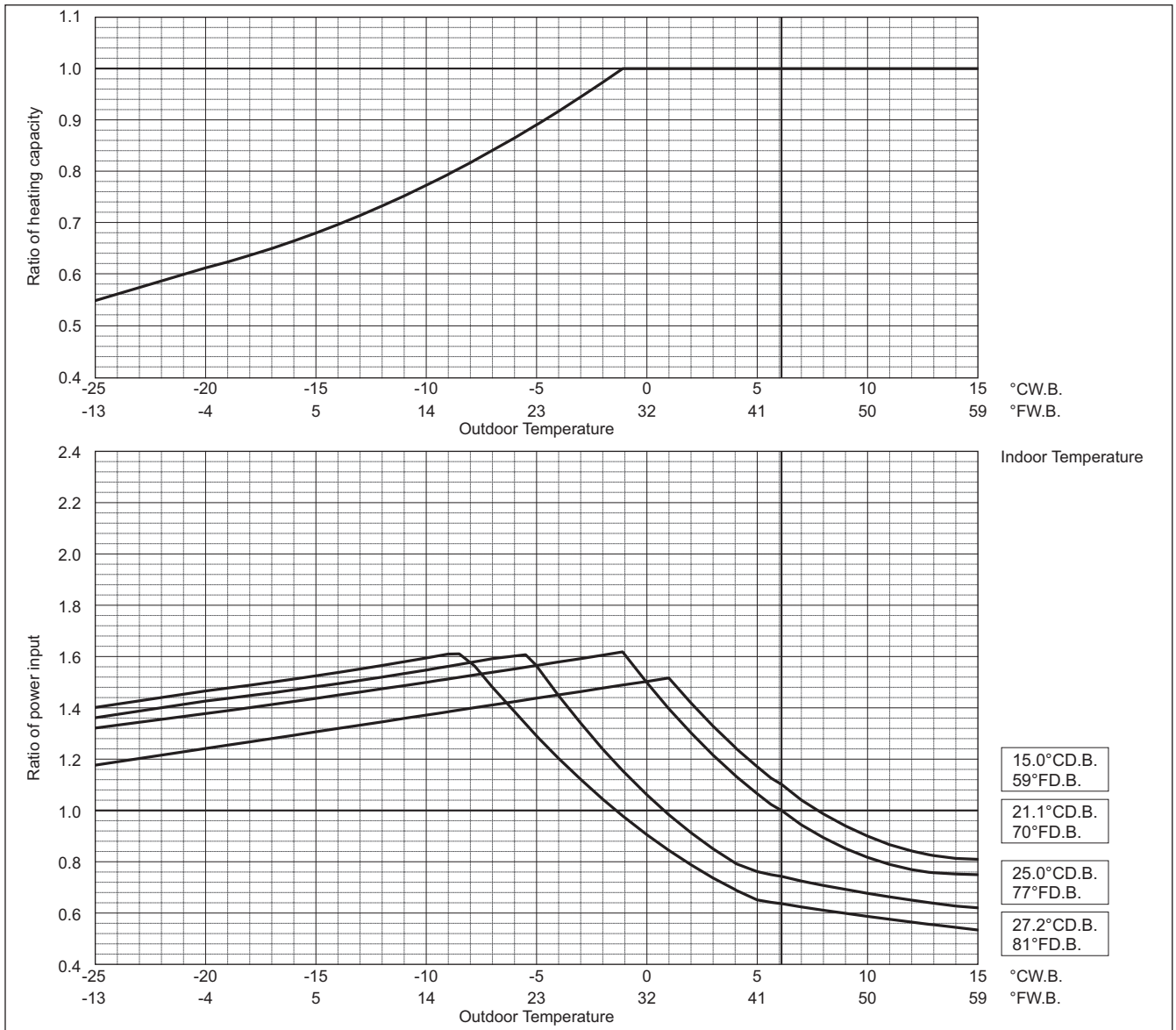

PURY-EP-T(S)NU-A, Y(S)NU-A

PURY-	EP192TNU/YNU		EP216TNU/YNU	
	Non-Ducted	Ducted	Non-Ducted	Ducted
Nominal cooling capacity	BTU/h	192,000	216,000	
	kW	56.3	63.3	
Input	kW	15.65	18.66	

Indoor unit temperature correction
To be used to correct indoor unit capacity only

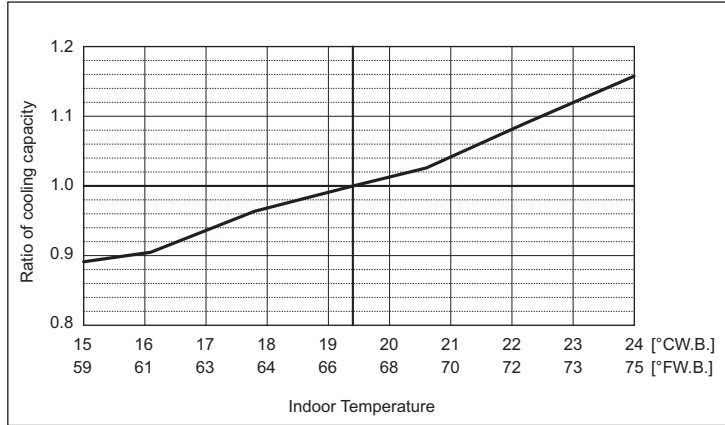

Outdoor unit temperature correction

To be used to correct outdoor unit only

Outdoor unit capacity is NOT affected by the indoor temperature.

Outdoor unit power input is affected by the indoor and outdoor temperatures. Please consult the sales office for details.

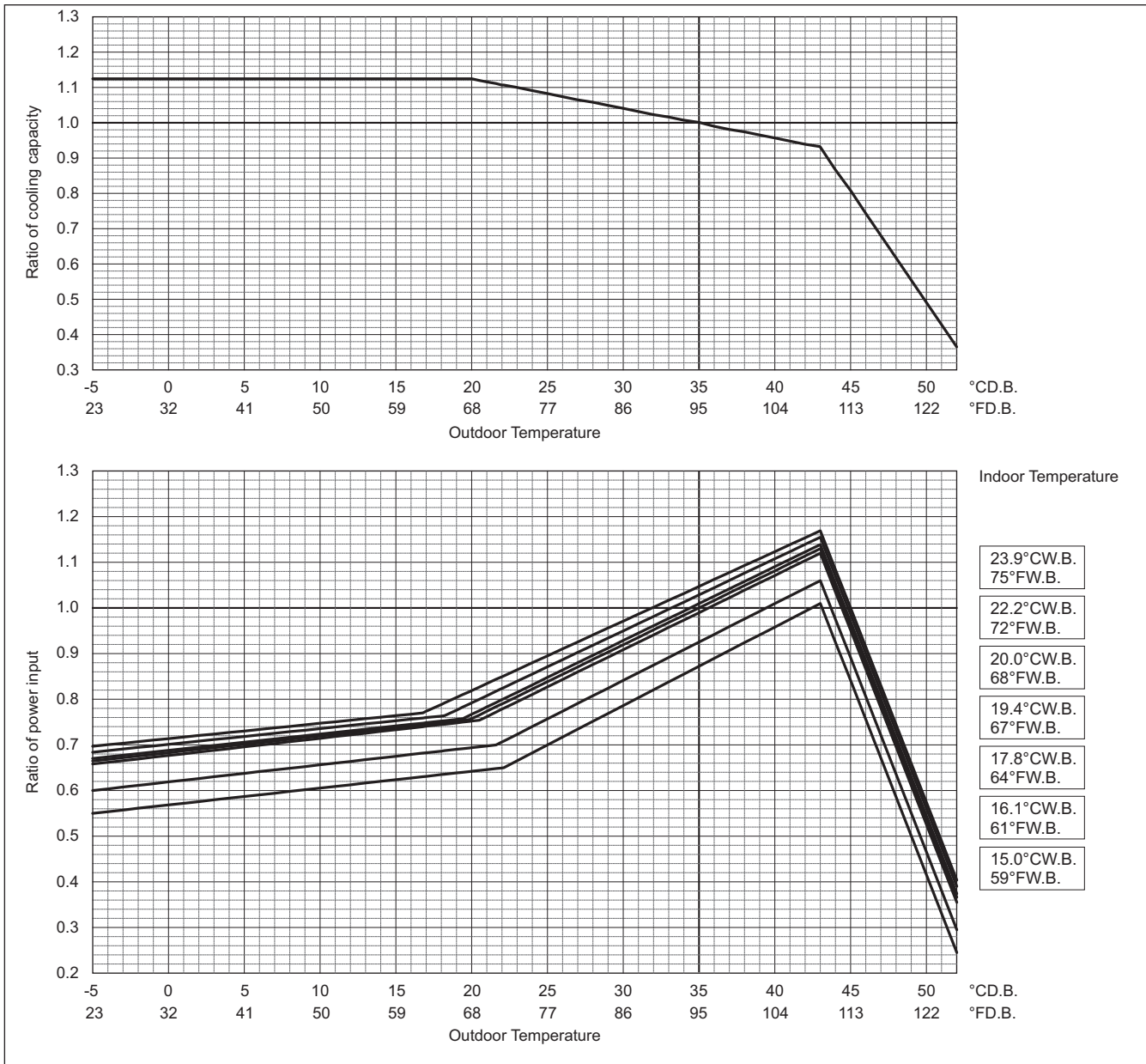

PURY-		EP192TNU/YNU		EP216TNU/YNU	
		Non-Ducted	Ducted	Non-Ducted	Ducted
Nominal Heating capacity	BTU/h	215,000		243,000	
	kW	63.0		71.2	
	Input kW	17.54		20.43	

Indoor unit temperature correction
To be used to correct indoor unit capacity only

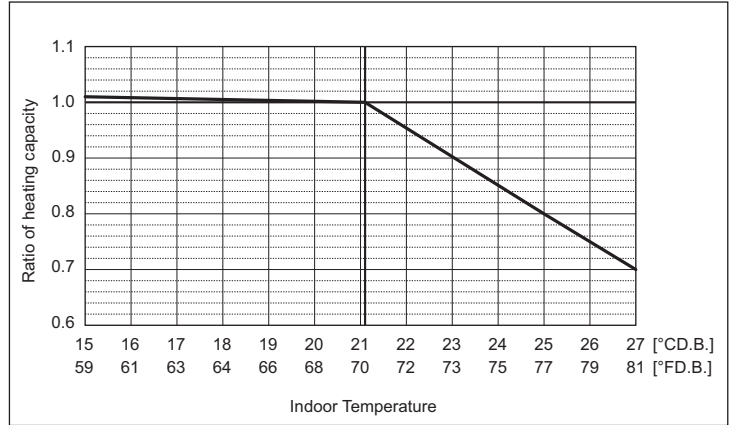

Outdoor unit temperature correction

To be used to correct outdoor unit only
Outdoor unit capacity is NOT affected by the indoor temperature.
Outdoor unit power input is affected by the indoor and outdoor temperatures. Please consult the sales office for details.

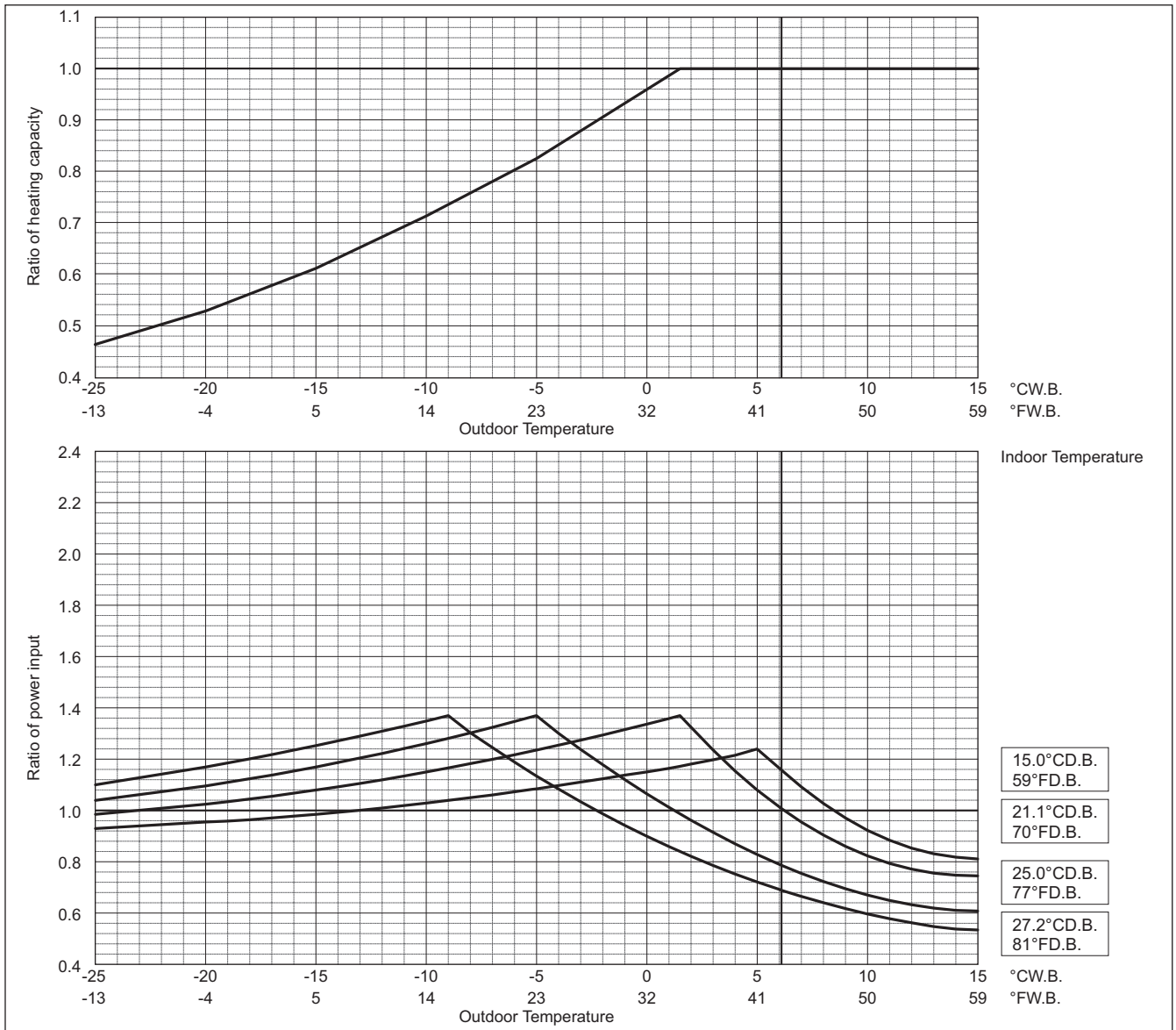

PURY-EP-T(S)NU-A, Y(S)NU-A

PURY-EP-T(S)NU-A, Y(S)NU-A

PURY-		EP240TNU/YNU	
		Non-Ducted	Ducted
Nominal cooling capacity	BTU/h	224,000	
	kW	65.7	
	Input kW	21.39	

Indoor unit temperature correction
To be used to correct indoor unit capacity only

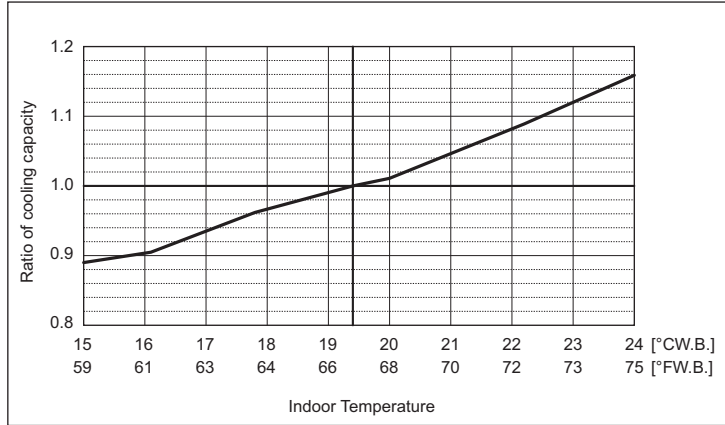

Outdoor unit temperature correction

To be used to correct outdoor unit only
Outdoor unit capacity is NOT affected by the indoor temperature.
Outdoor unit power input is affected by the indoor and outdoor temperatures. Please consult the sales office for details.

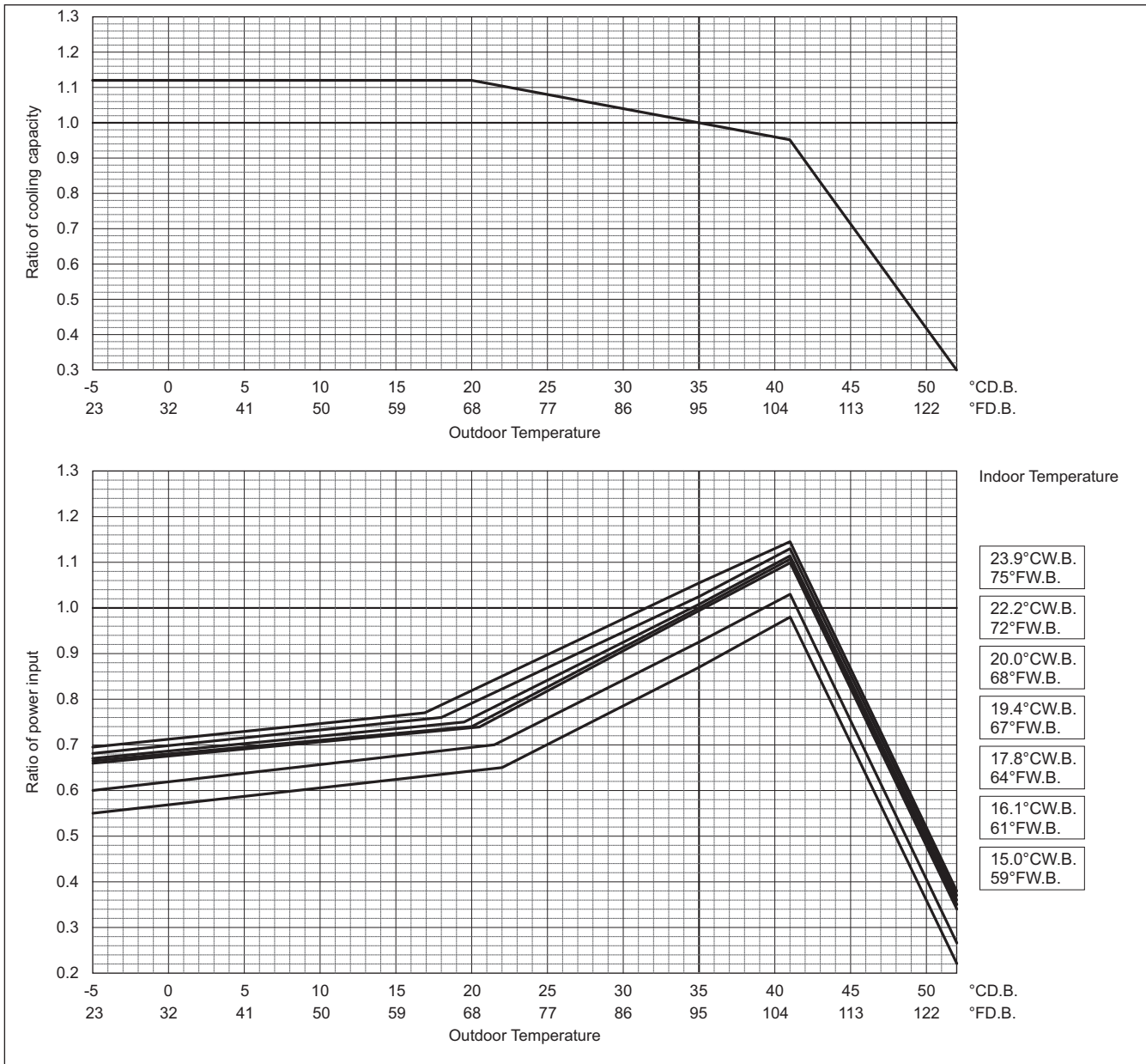

PURY-		EP240TNU/YNU	
		Non-Ducted	Ducted
Nominal Heating capacity	BTU/h	250,000	
	kW	73.3	
	Input kW	21.79	

Indoor unit temperature correction
To be used to correct indoor unit capacity only

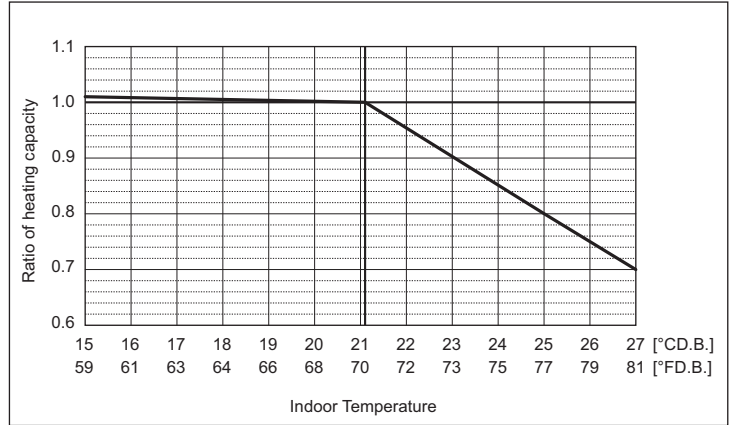

Outdoor unit temperature correction

To be used to correct outdoor unit only
Outdoor unit capacity is NOT affected by the indoor temperature.
Outdoor unit power input is affected by the indoor and outdoor temperatures. Please consult the sales office for details.

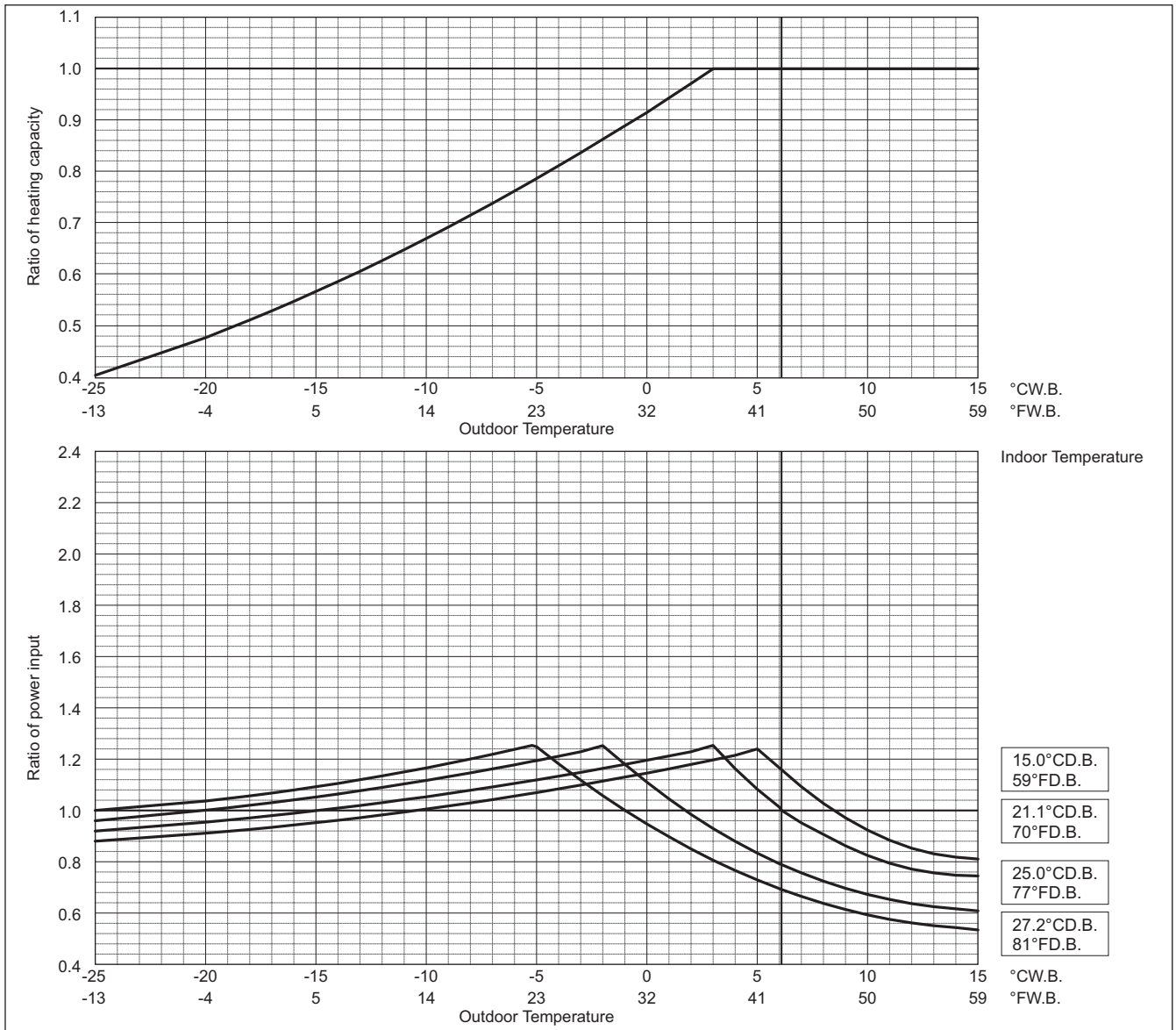

PURY-EP-T(S)NU-A, Y(S)NU-A

PURY-EP-T(S)NU-A, Y(S)NU-A

PURY-		EP192TSNU/YSNU	
		Non-Ducted	Ducted
Nominal cooling capacity	BTU/h	192,000	
	kW	56.3	
	Input kW	13.60	

Indoor unit temperature correction
To be used to correct indoor unit capacity only

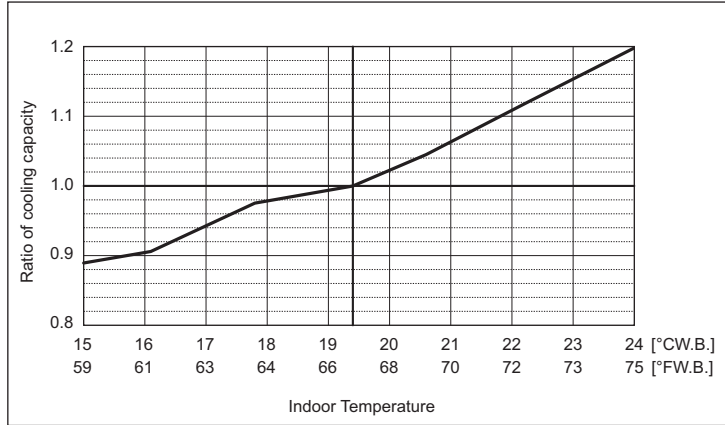

Outdoor unit temperature correction

To be used to correct outdoor unit only

Outdoor unit capacity is NOT affected by the indoor temperature.

Outdoor unit power input is affected by the indoor and outdoor temperatures. Please consult the sales office for details.

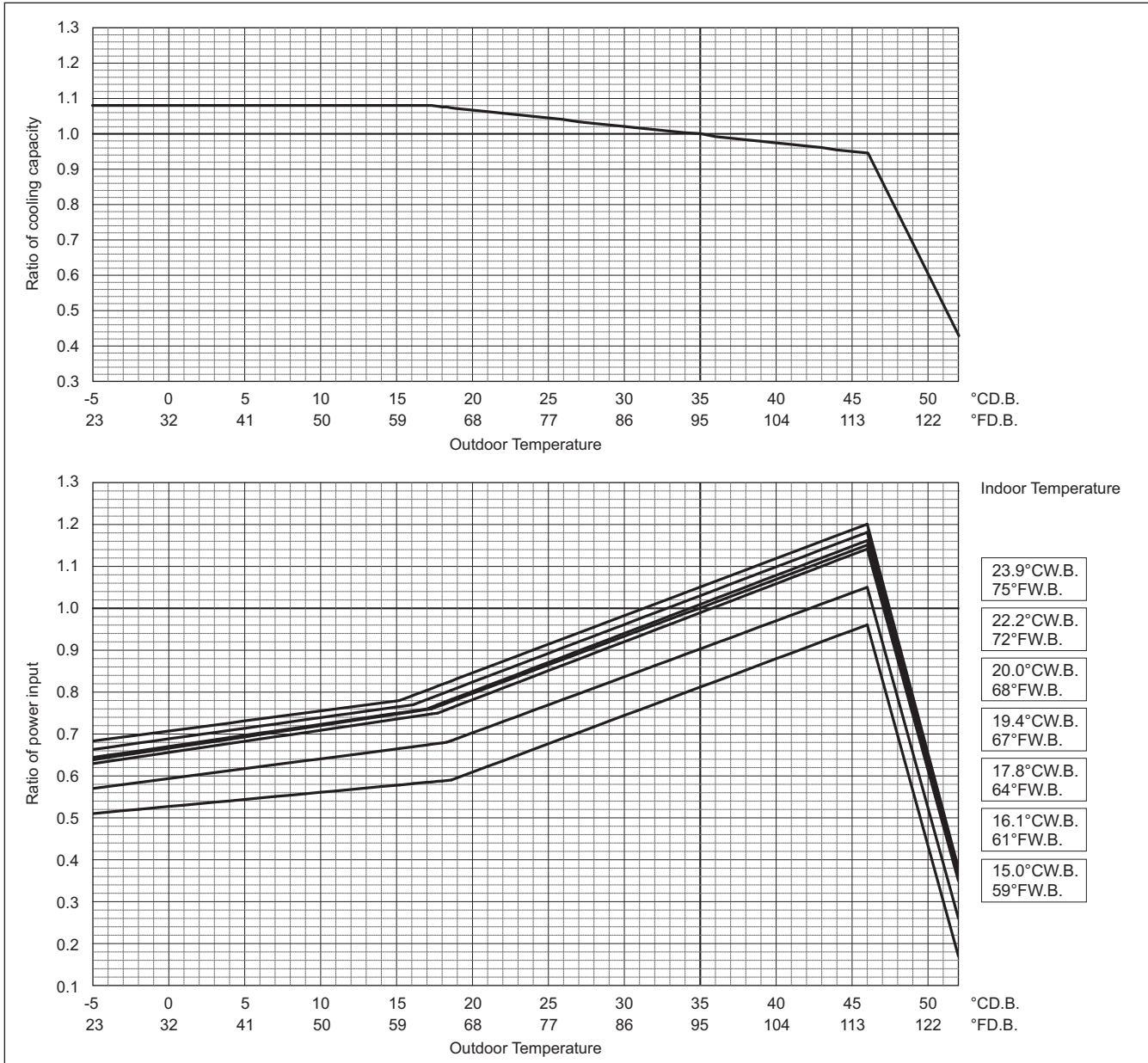

PURY-		EP192TSNU/YSNU	
		Non-Ducted	Ducted
Nominal Heating capacity	BTU/h	215,000	
	kW	63.0	
	Input kW	16.02	

Indoor unit temperature correction
To be used to correct indoor unit capacity only

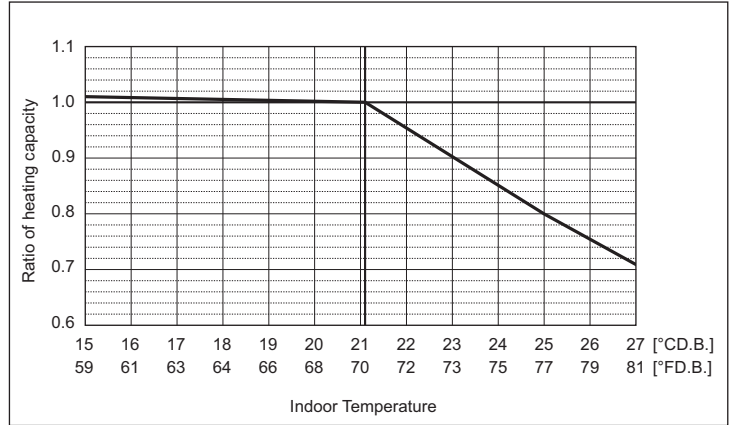

Outdoor unit temperature correction

To be used to correct outdoor unit only
Outdoor unit capacity is NOT affected by the indoor temperature.
Outdoor unit power input is affected by the indoor and outdoor temperatures. Please consult the sales office for details.

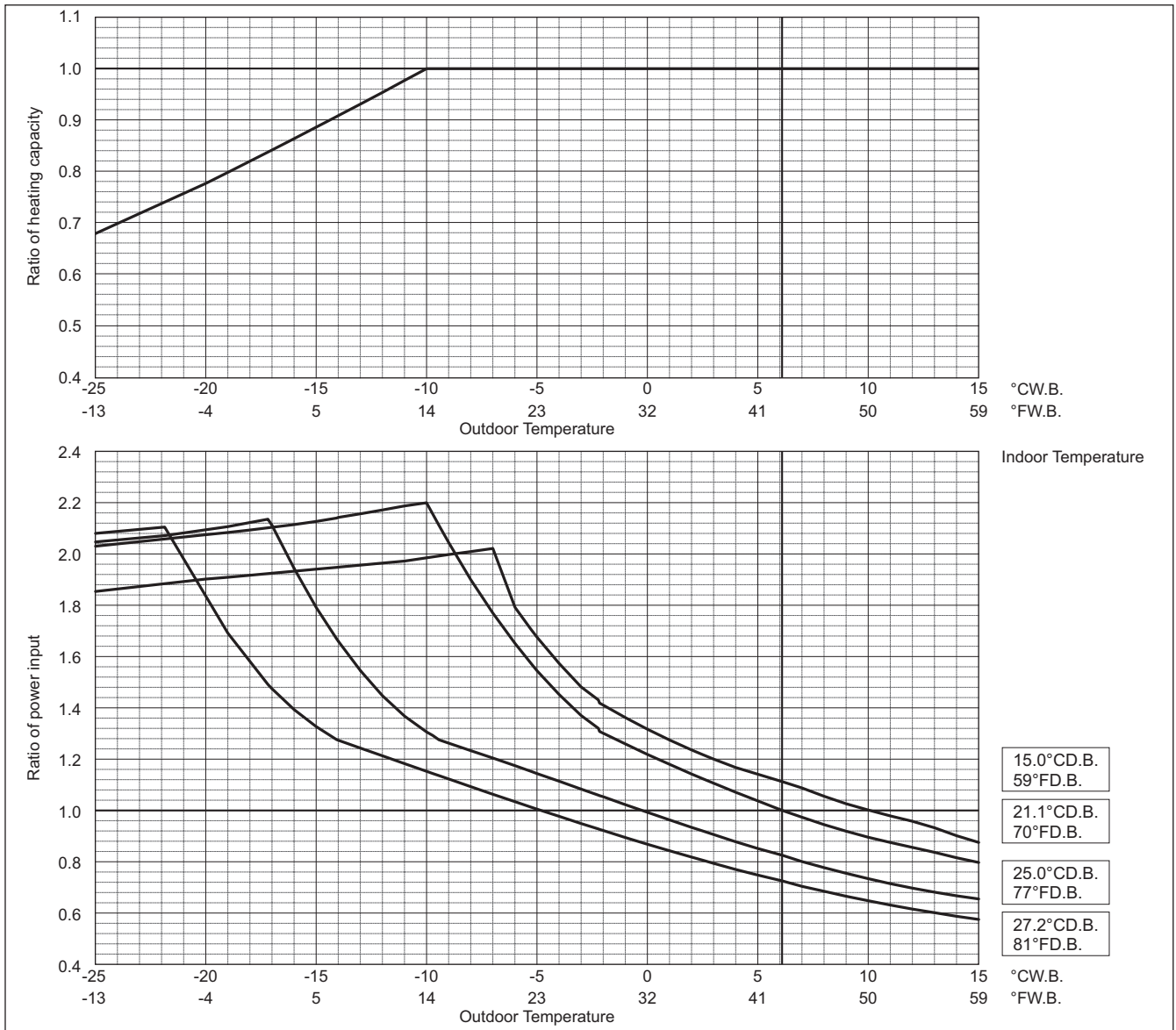

PURY-EP-T(S)NU-A, Y(S)NU-A

PURY-EP-T(S)NU-A, Y(S)NU-A

PURY-	EP216TSNU/YSNU		EP240TSNU/YSNU	
	Non-Ducted	Ducted	Non-Ducted	Ducted
Nominal cooling capacity	216,000		240,000	
BTU/h	216,000		240,000	
kW	63.3		70.3	
Input kW	16.06		19.17	

Indoor unit temperature correction
To be used to correct indoor unit capacity only

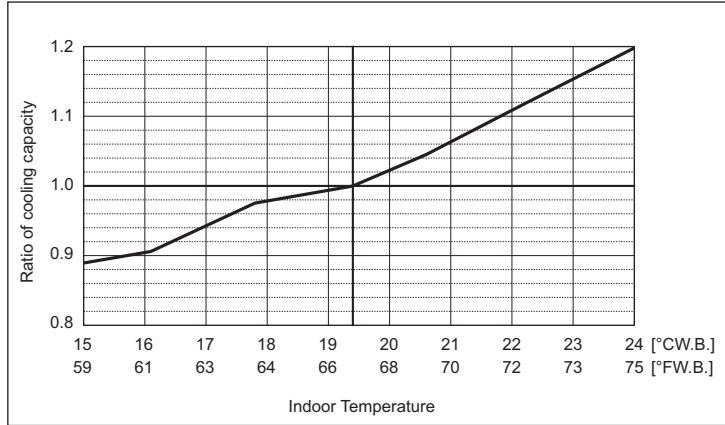

Outdoor unit temperature correction

To be used to correct outdoor unit only
Outdoor unit capacity is NOT affected by the indoor temperature.
Outdoor unit power input is affected by the indoor and outdoor temperatures. Please consult the sales office for details.

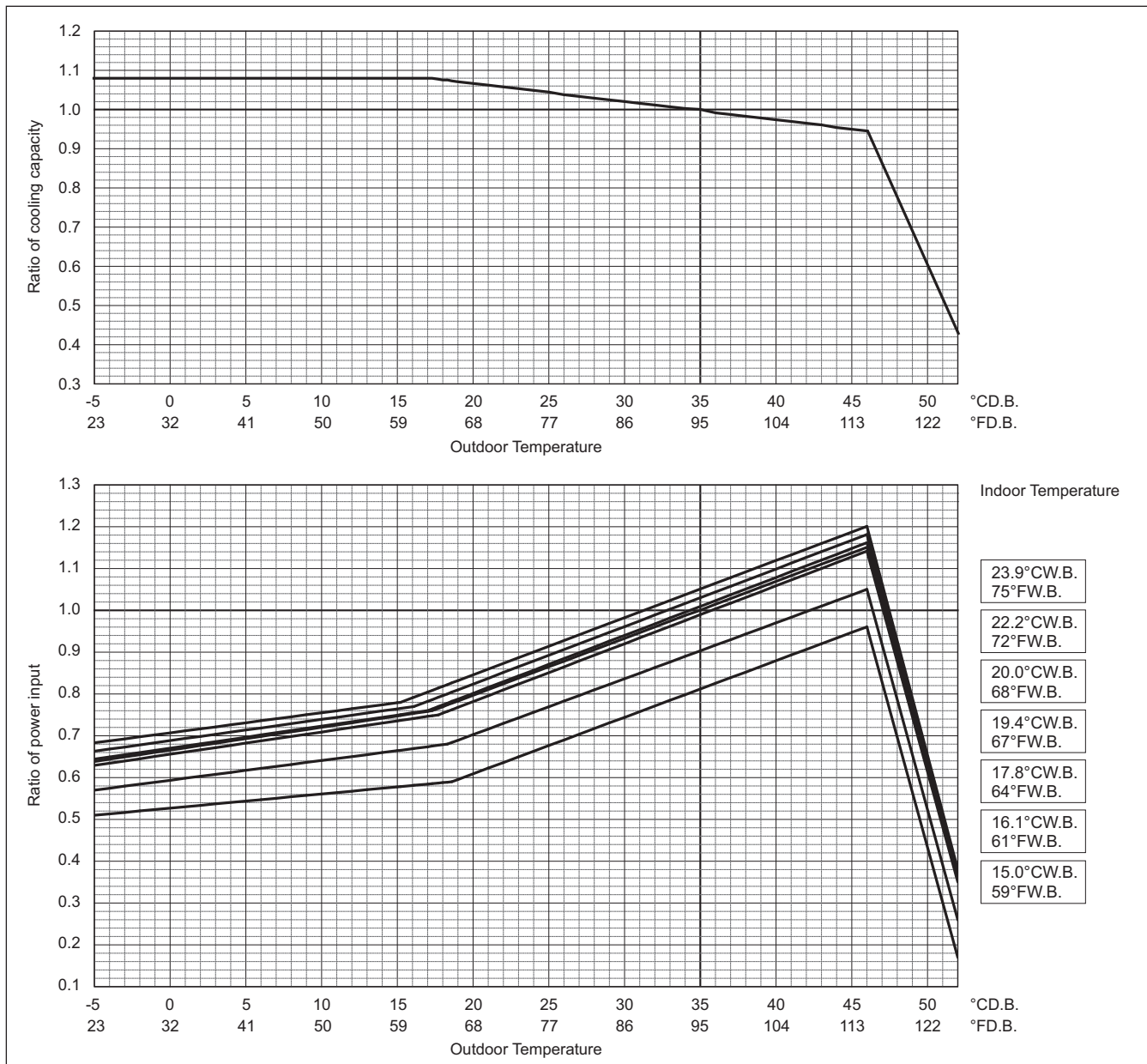

PURY-		EP216TSNU/YSNU		EP240TSNU/YSNU	
		Non-Ducted	Ducted	Non-Ducted	Ducted
Nominal Heating capacity	BTU/h	243,000		270,000	
	kW	71.2		79.1	
	Input kW	18.67		22.03	

Indoor unit temperature correction
To be used to correct indoor unit capacity only

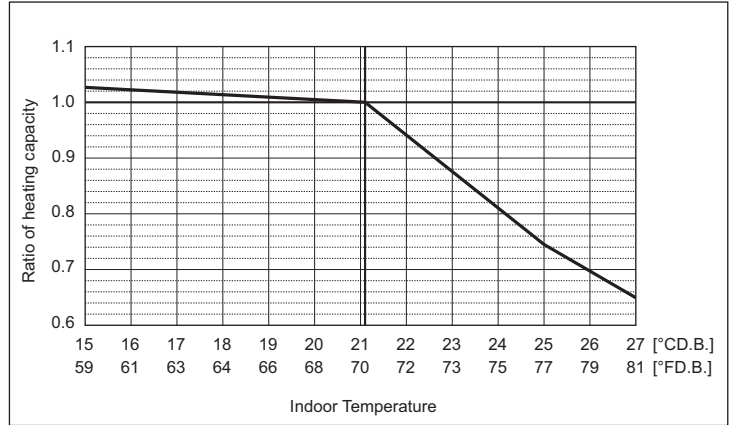

Outdoor unit temperature correction

To be used to correct outdoor unit only
Outdoor unit capacity is NOT affected by the indoor temperature.
Outdoor unit power input is affected by the indoor and outdoor temperatures. Please consult the sales office for details.

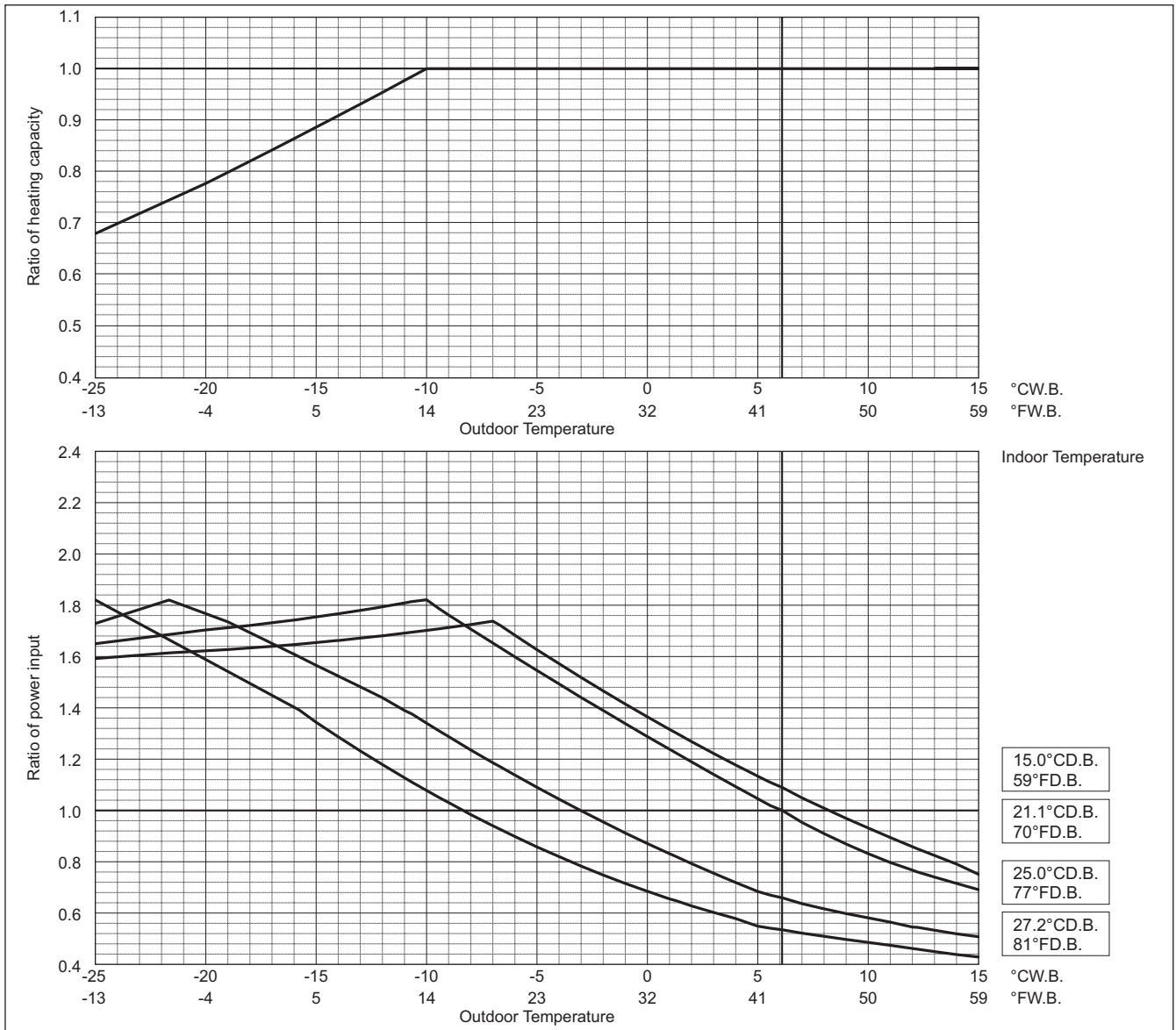

PURY-EP-T(S)NU-A, Y(S)NU-A

PURY-EP-T(S)NU-A, Y(S)NU-A

PURY-		EP264TSNU/YSNU	
		Non-Ducted	Ducted
Nominal cooling capacity	BTU/h	264,000	
	kW	77.4	
	Input kW	21.86	

Indoor unit temperature correction
To be used to correct indoor unit capacity only

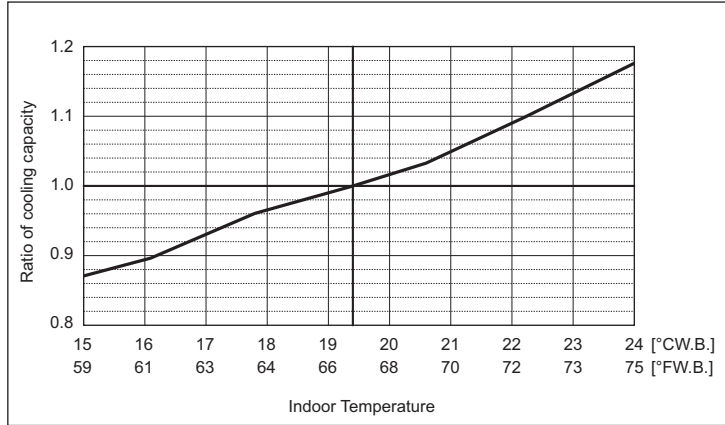

Outdoor unit temperature correction

To be used to correct outdoor unit only
Outdoor unit capacity is NOT affected by the indoor temperature.
Outdoor unit power input is affected by the indoor and outdoor temperatures. Please consult the sales office for details.

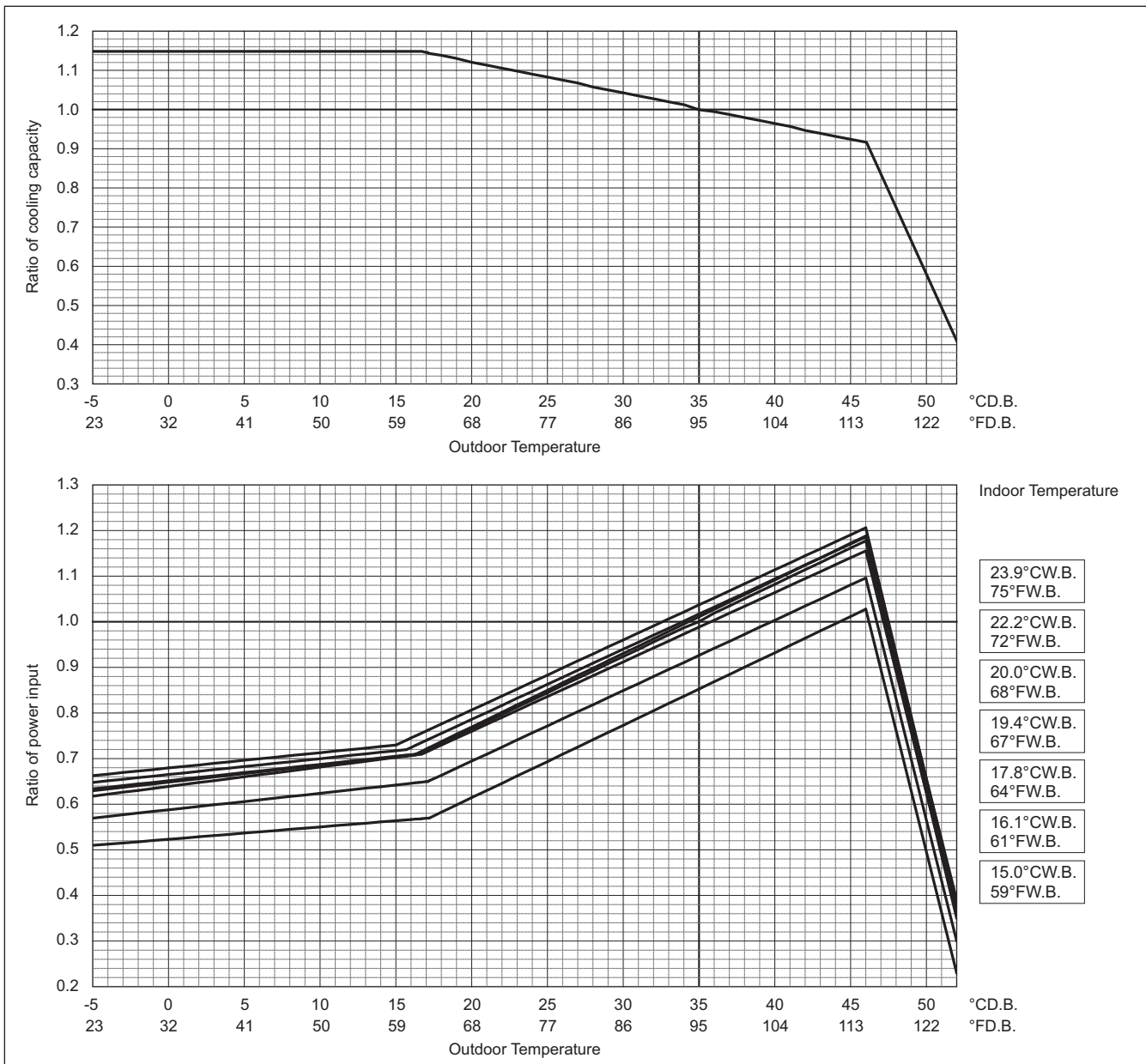

PURY-		EP264TSNU/YSNU	
		Non-Ducted	Ducted
Nominal Heating capacity	BTU/h	295,000	
	kW	86.5	
	Input kW	24.56	

Indoor unit temperature correction
To be used to correct indoor unit capacity only

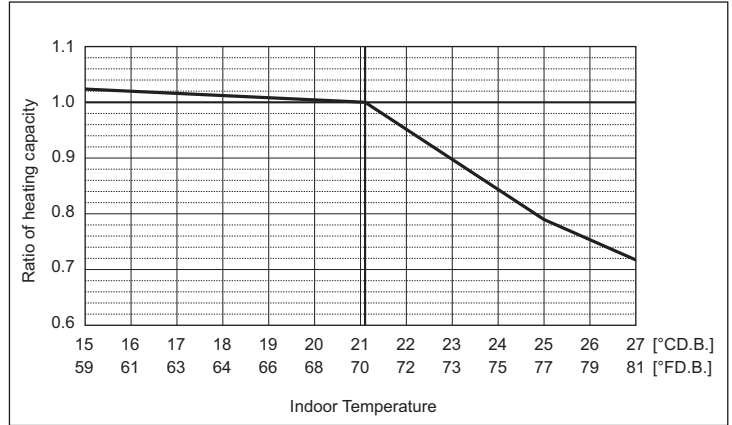

Outdoor unit temperature correction

To be used to correct outdoor unit only
Outdoor unit capacity is NOT affected by the indoor temperature.
Outdoor unit power input is affected by the indoor and outdoor temperatures. Please consult the sales office for details.

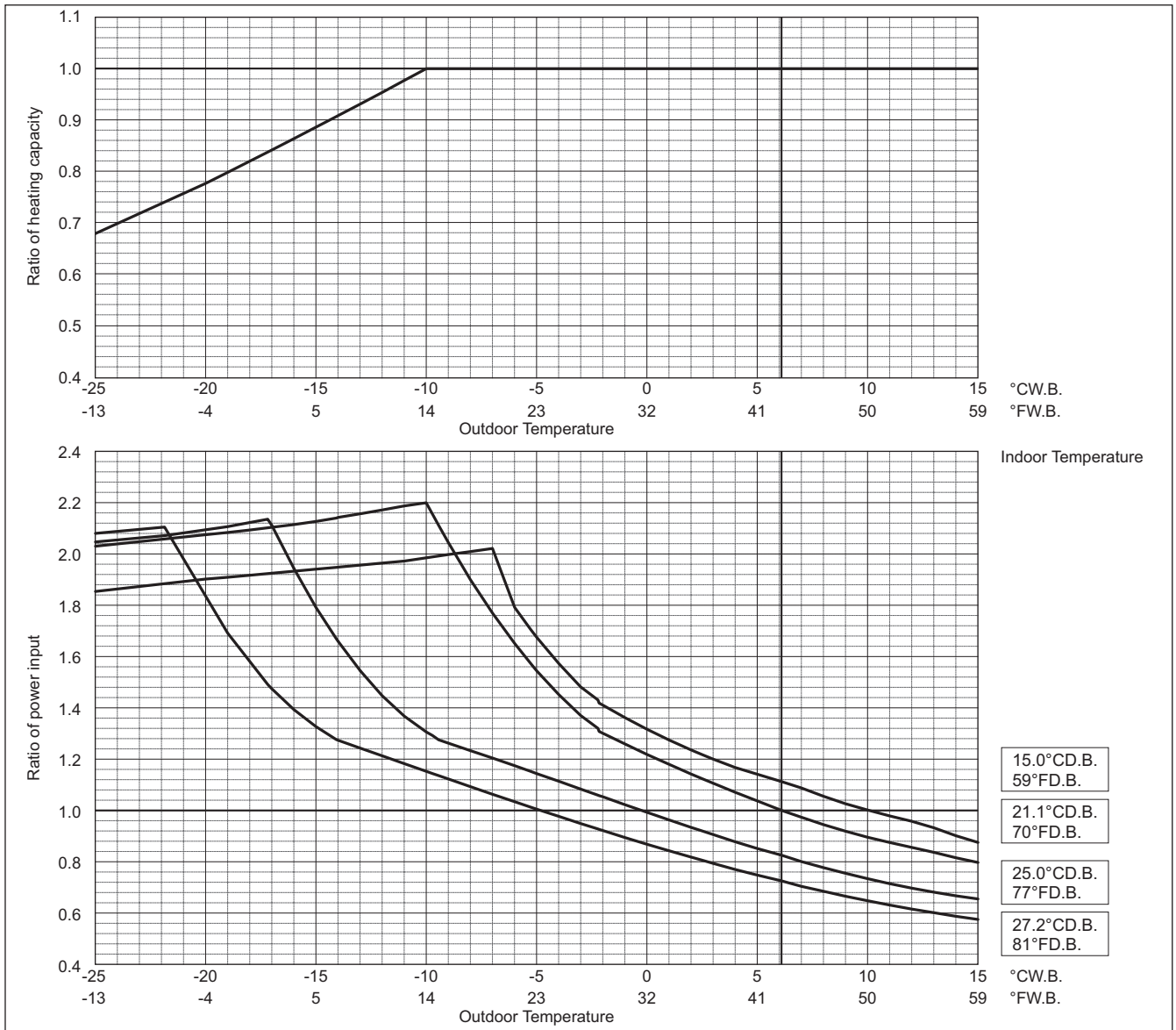

PURY-EP-T(S)NU-A, Y(S)NU-A

PURY-EP-T(S)NU-A, Y(S)NU-A

PURY-		EP288TSNU/YSNU	
		Non-Ducted	Ducted
Nominal cooling capacity	BTU/h	288,000	
	kW	84.4	
	Input kW	24.83	

Indoor unit temperature correction
To be used to correct indoor unit capacity only

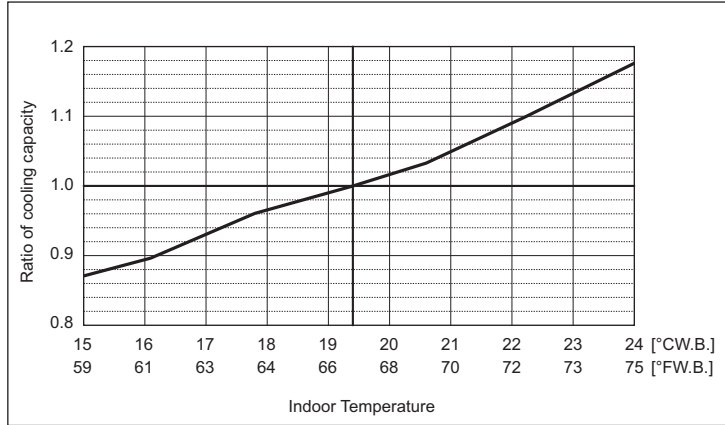

Outdoor unit temperature correction

To be used to correct outdoor unit only
Outdoor unit capacity is NOT affected by the indoor temperature.
Outdoor unit power input is affected by the indoor and outdoor temperatures. Please consult the sales office for details.

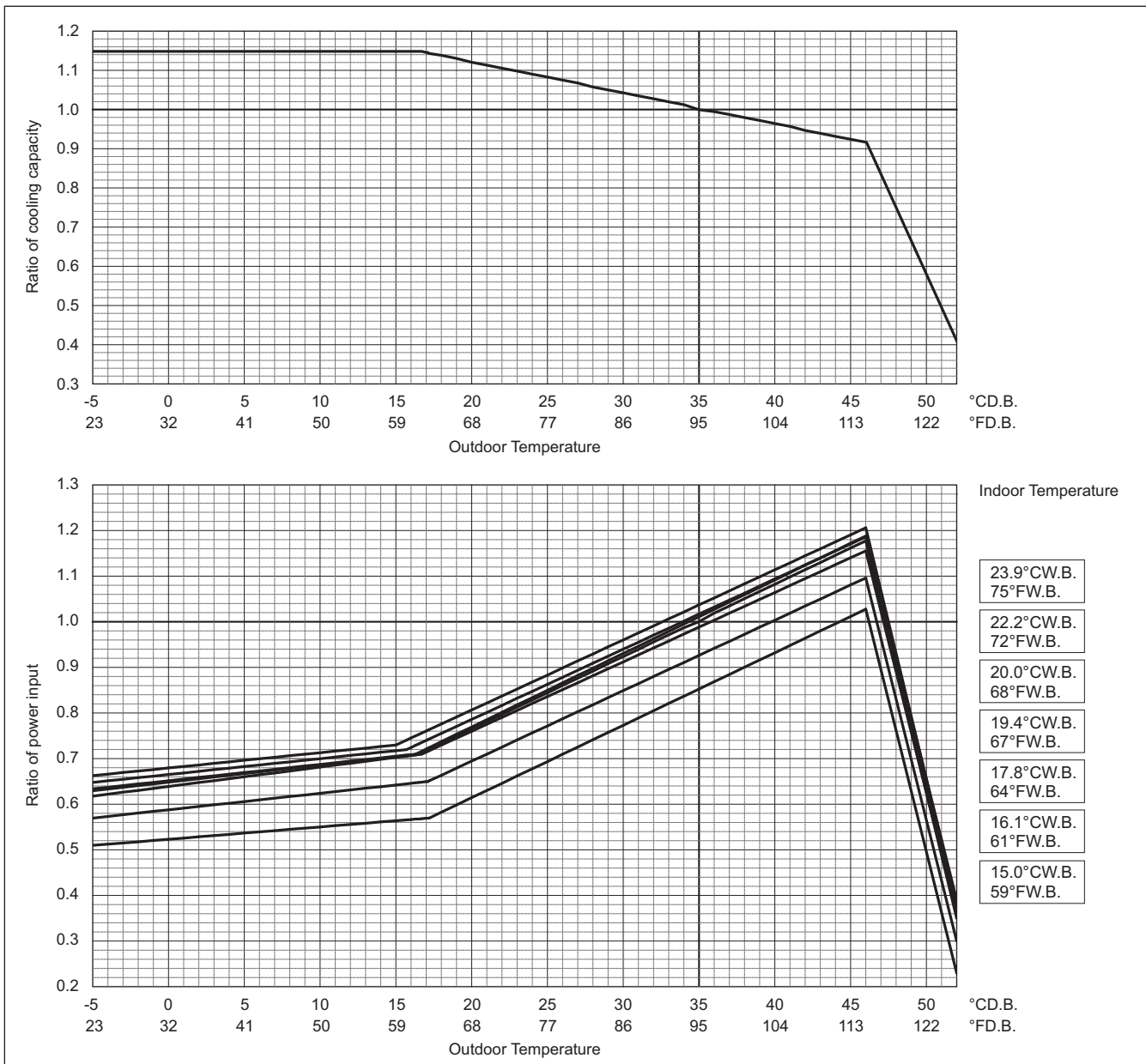

PURY-		EP288TSNU/YSNU	
		Non-Ducted	Ducted
Nominal Heating capacity	BTU/h	323,000	
	kW	94.7	
	Input kW	27.30	

Indoor unit temperature correction
To be used to correct indoor unit capacity only

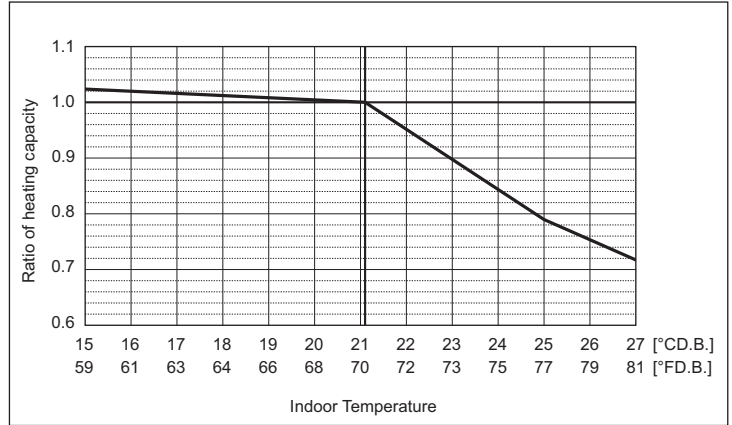

Outdoor unit temperature correction

To be used to correct outdoor unit only
Outdoor unit capacity is NOT affected by the indoor temperature.
Outdoor unit power input is affected by the indoor and outdoor temperatures. Please consult the sales office for details.

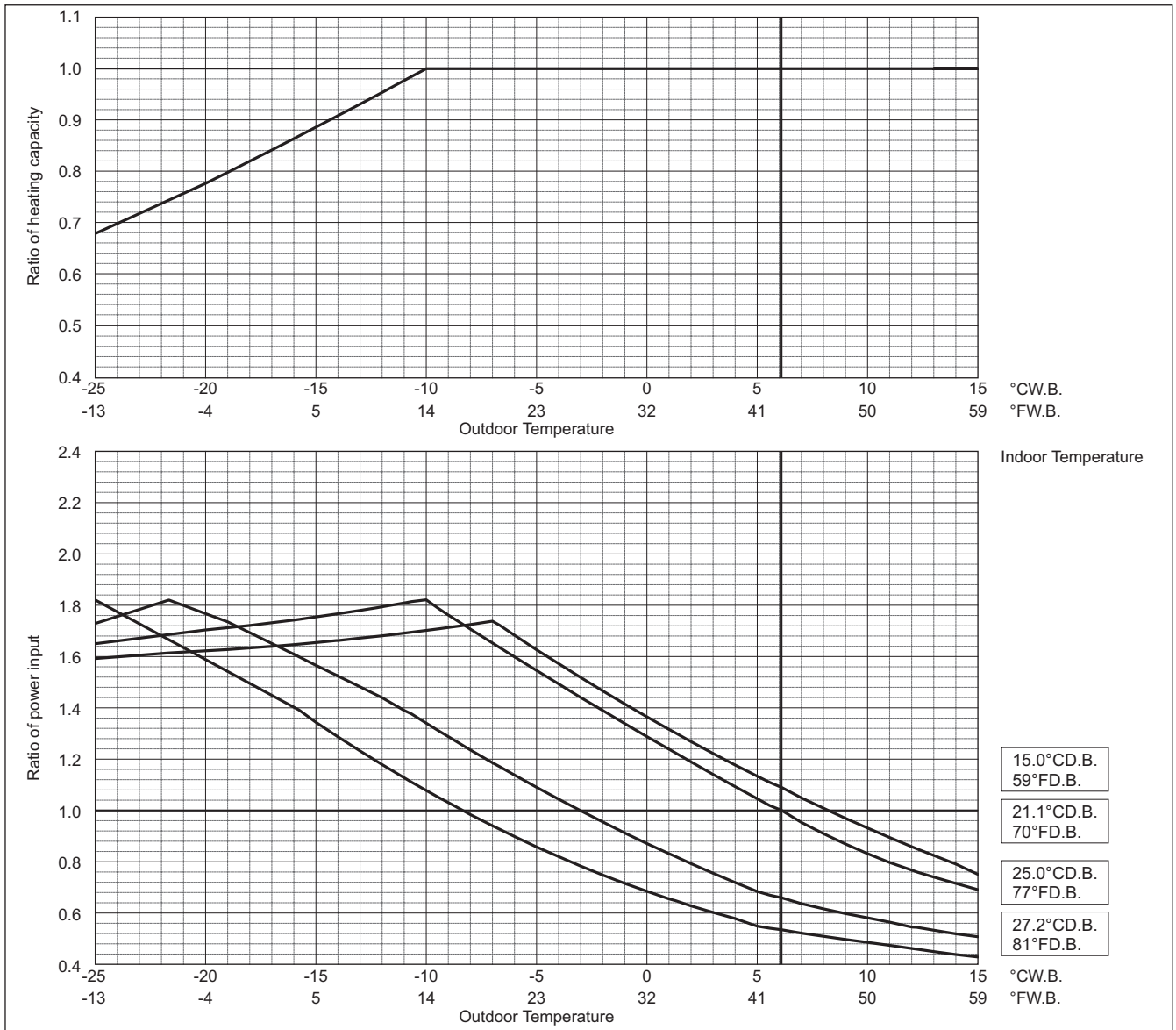

PURY-EP-T(S)NU-A, Y(S)NU-A

PURY-EP-T(S)NU-A, Y(S)NU-A

PURY-	EP312TSNU/YSNU		EP336TSNU/YSNU	
	Non-Ducted	Ducted	Non-Ducted	Ducted
Nominal cooling capacity	312,000		336,000	
Input	27.98		31.43	
	BTU/h	312,000	336,000	
	kW	91.4	98.5	

Indoor unit temperature correction
To be used to correct indoor unit capacity only

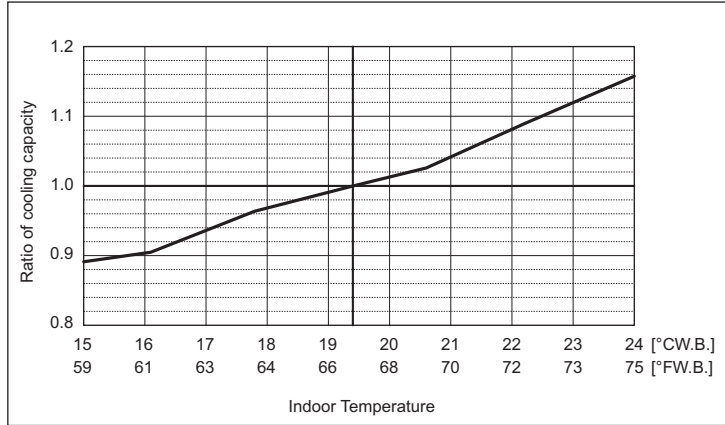

Outdoor unit temperature correction

To be used to correct outdoor unit only
Outdoor unit capacity is NOT affected by the indoor temperature.
Outdoor unit power input is affected by the indoor and outdoor temperatures. Please consult the sales office for details.

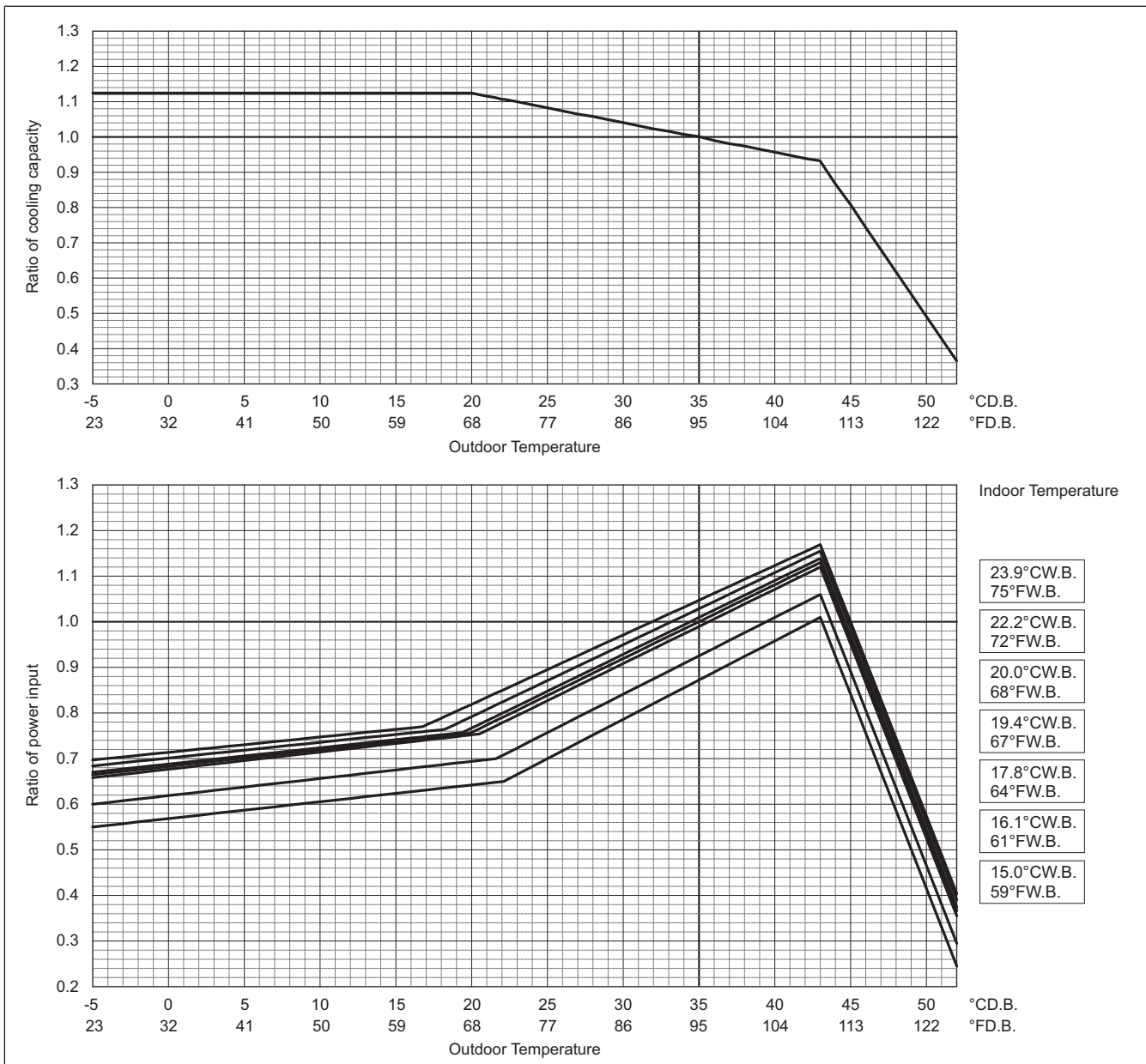

PURY-		EP312TSNU/YSNU		EP336TSNU/YSNU	
		Non-Ducted	Ducted	Non-Ducted	Ducted
Nominal Heating capacity	BTU/h	350,000		378,000	
	kW	102.6		110.8	
	Input kW	30.53		33.55	

Indoor unit temperature correction
To be used to correct indoor unit capacity only

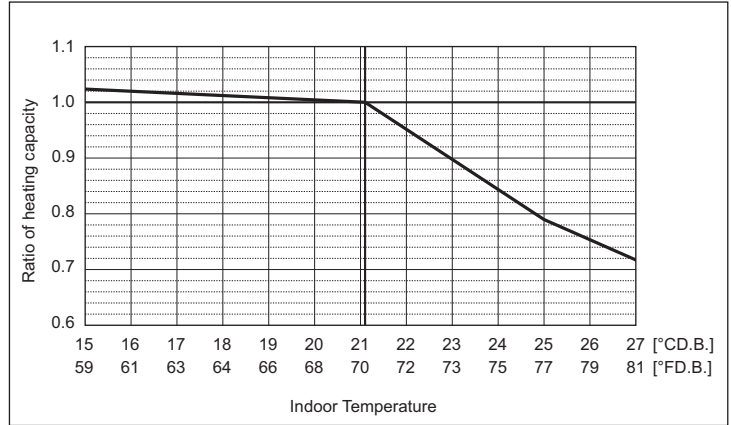

Outdoor unit temperature correction

To be used to correct outdoor unit only
Outdoor unit capacity is NOT affected by the indoor temperature.
Outdoor unit power input is affected by the indoor and outdoor temperatures. Please consult the sales office for details.

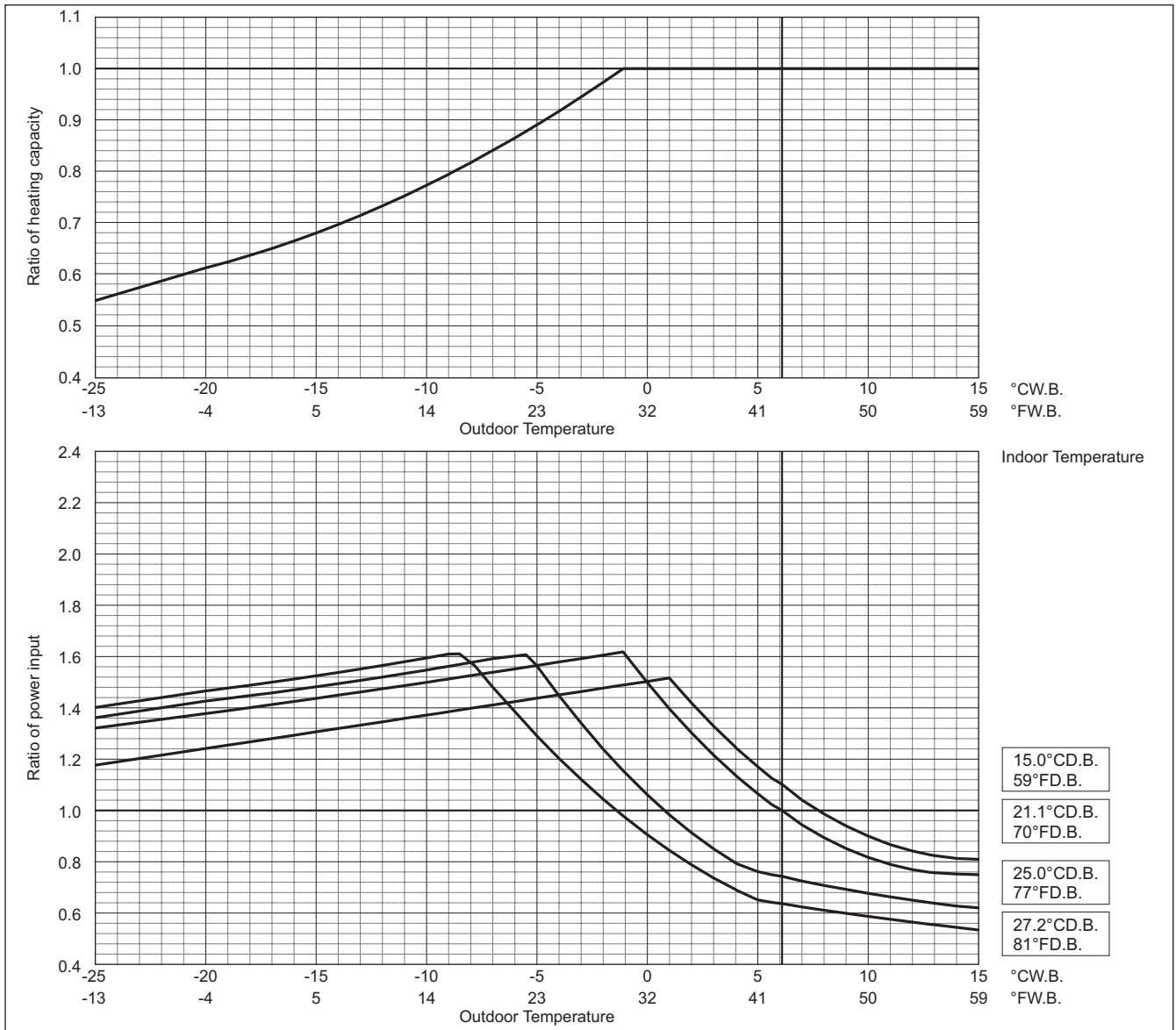

PURY-EP-T(S)NU-A, Y(S)NU-A

PURY-EP-T(S)NU-A, Y(S)NU-A

PURY-	EP384TSNU/YSNU		EP432TSNU/YSNU	
	Non-Ducted	Ducted	Non-Ducted	Ducted
Nominal cooling capacity	384,000		432,000	
Input	36.62		42.36	
	BTU/h			
	kW	112.5	126.6	
	kW	36.62	42.36	

Indoor unit temperature correction
To be used to correct indoor unit capacity only

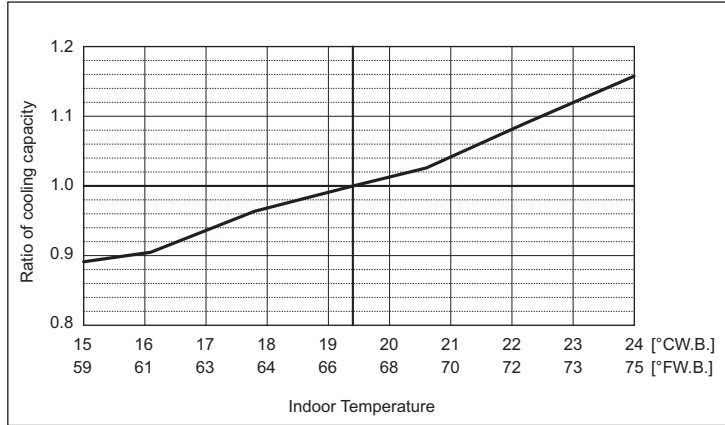

Outdoor unit temperature correction

To be used to correct outdoor unit only
Outdoor unit capacity is NOT affected by the indoor temperature.
Outdoor unit power input is affected by the indoor and outdoor temperatures. Please consult the sales office for details.

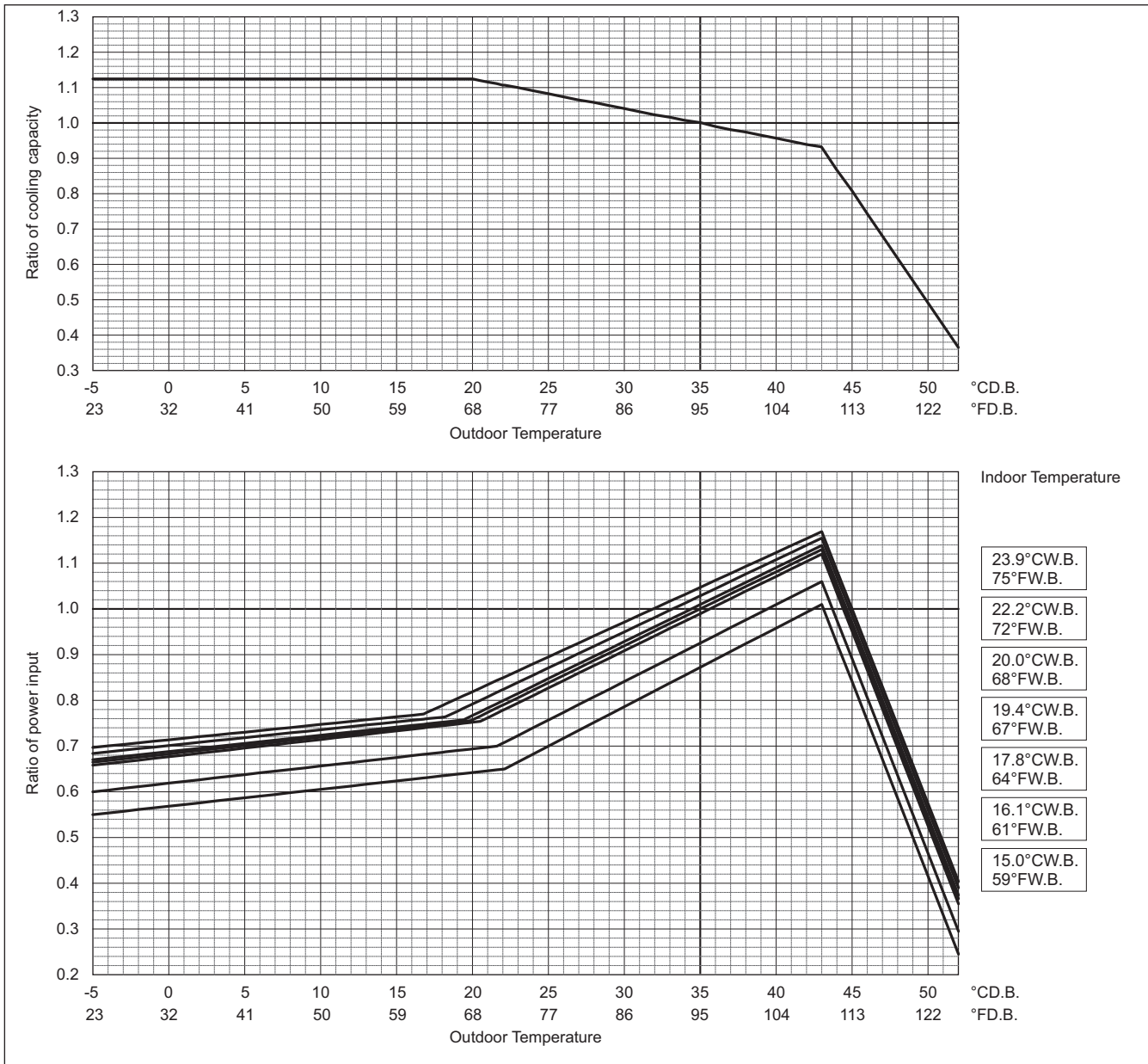

PURY-		EP384TSNU/YSNU		EP432TSNU/YSNU	
		Non-Ducted	Ducted	Non-Ducted	Ducted
Nominal Heating capacity	BTU/h	430,000		480,000	
	kW	126.0		140.7	
	Input kW	38.66		43.14	

Indoor unit temperature correction
To be used to correct indoor unit capacity only

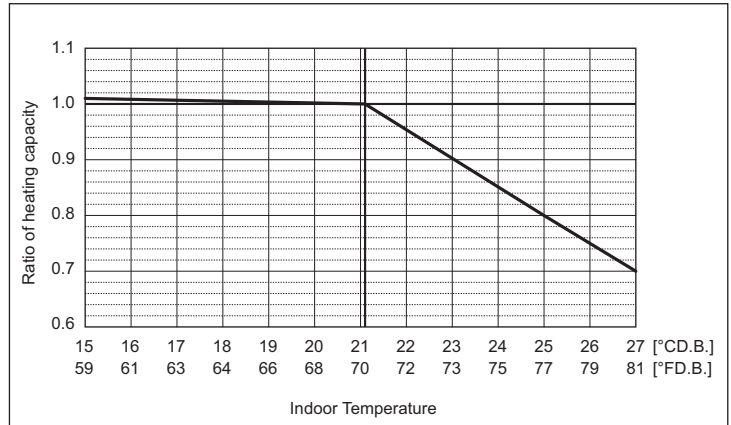

Outdoor unit temperature correction

To be used to correct outdoor unit only

Outdoor unit capacity is NOT affected by the indoor temperature.

Outdoor unit power input is affected by the indoor and outdoor temperatures. Please consult the sales office for details.

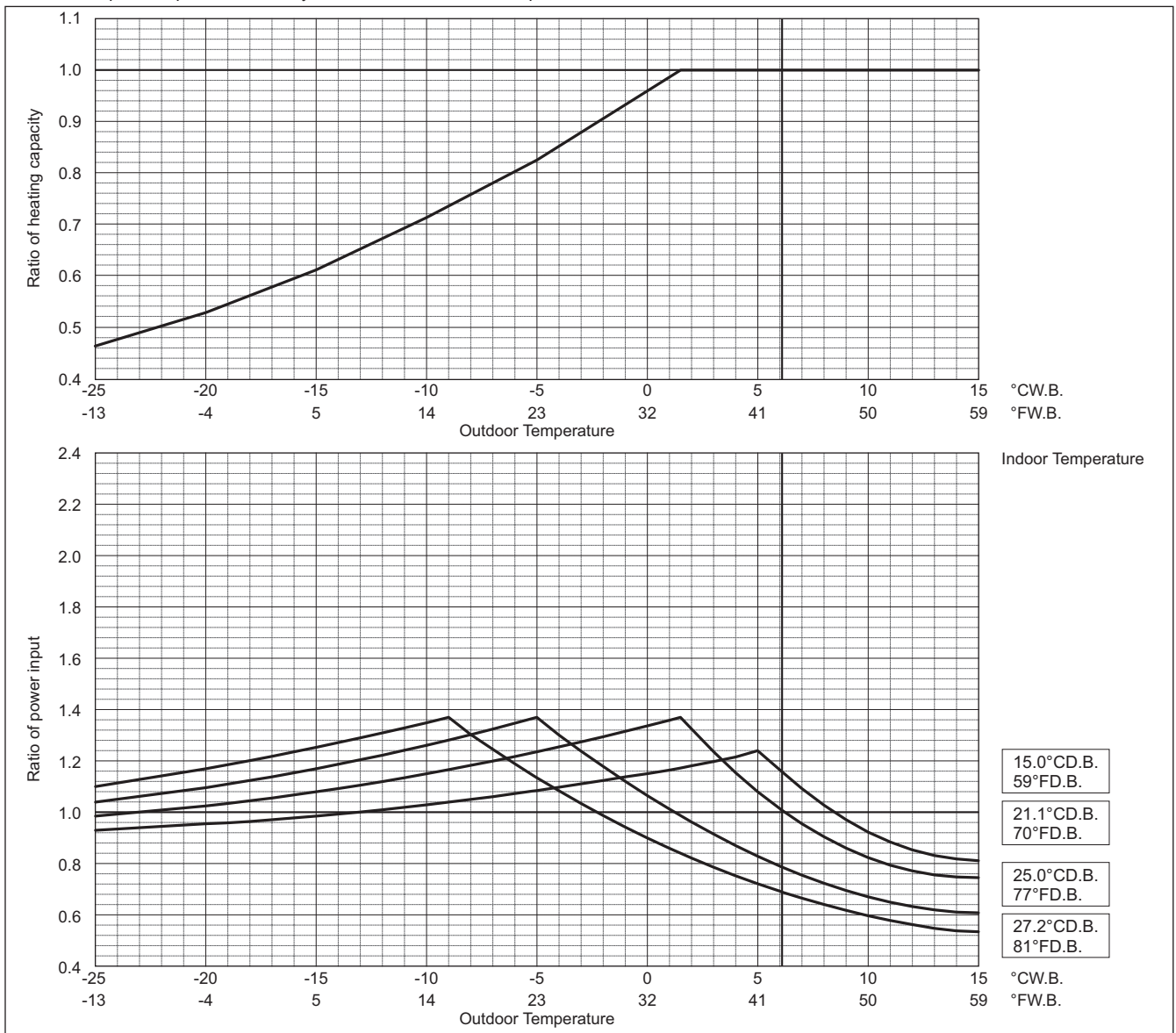

Correction by temperature (COP Priority Mode only for heating)

CITY MULTI could have various capacities at different designing temperatures. Using the nominal cooling/heating capacity values and the ratios below, the capacity can be found for various temperatures. To select COP priority mode, SW4 (935) must be set to ON.

PURY-		EP72TNU/YNU	
		Non-Ducted	Ducted
Nominal cooling capacity	BTU/h	72,000	
	kW	21.1	
	Input kW	4.44	

Indoor unit temperature correction

To be used to correct indoor unit capacity only

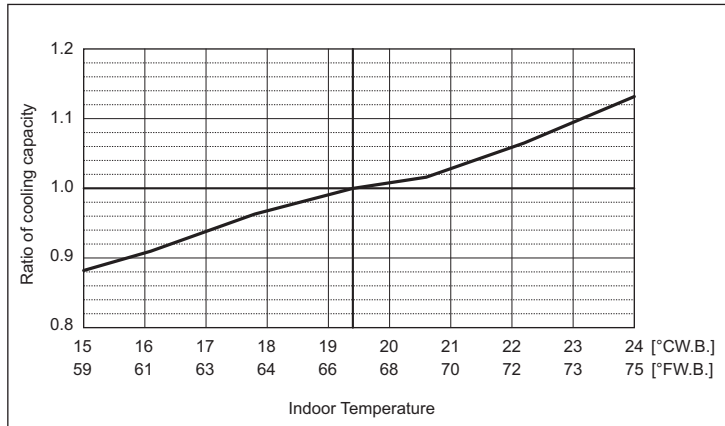

Outdoor unit temperature correction

To be used to correct outdoor unit only

Outdoor unit capacity is NOT affected by the indoor temperature.

Outdoor unit power input is affected by the indoor and outdoor temperatures. Please consult the sales office for details.

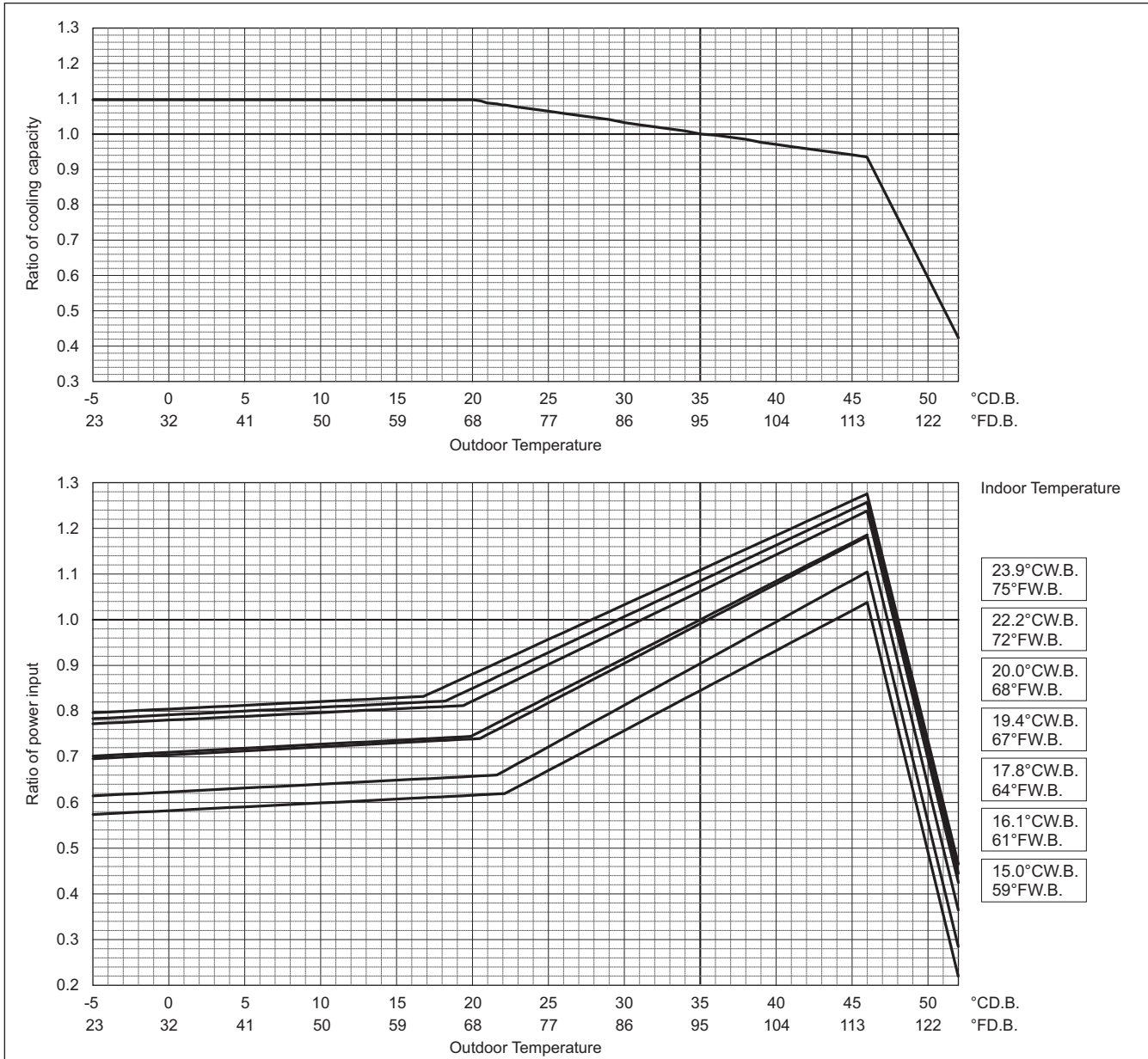

PURY-EP-T(S)NU-A, Y(S)NU-A

COP Priority Mode

PURY-		EP72TNU/YNU	
		Non-Ducted	Ducted
Nominal Heating capacity	BTU/h	80,000	
	kW	23.4	
	Input kW	5.43	

Indoor unit temperature correction

To be used to correct indoor unit capacity only

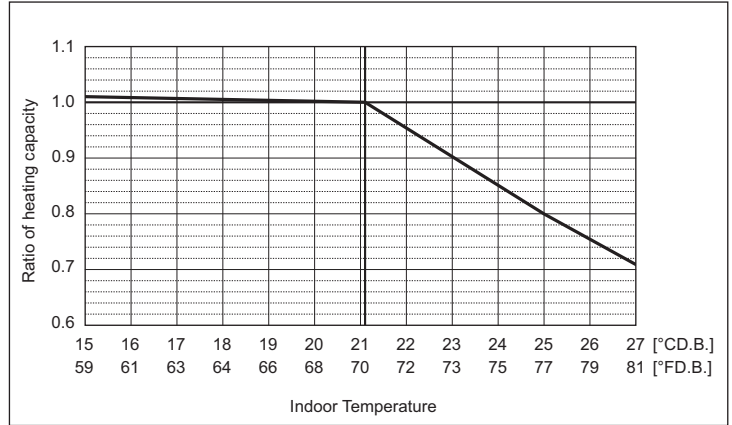

Outdoor unit temperature correction

To be used to correct outdoor unit only

Outdoor unit capacity is NOT affected by the indoor temperature.

Outdoor unit power input is affected by the indoor and outdoor temperatures. Please consult the sales office for details.

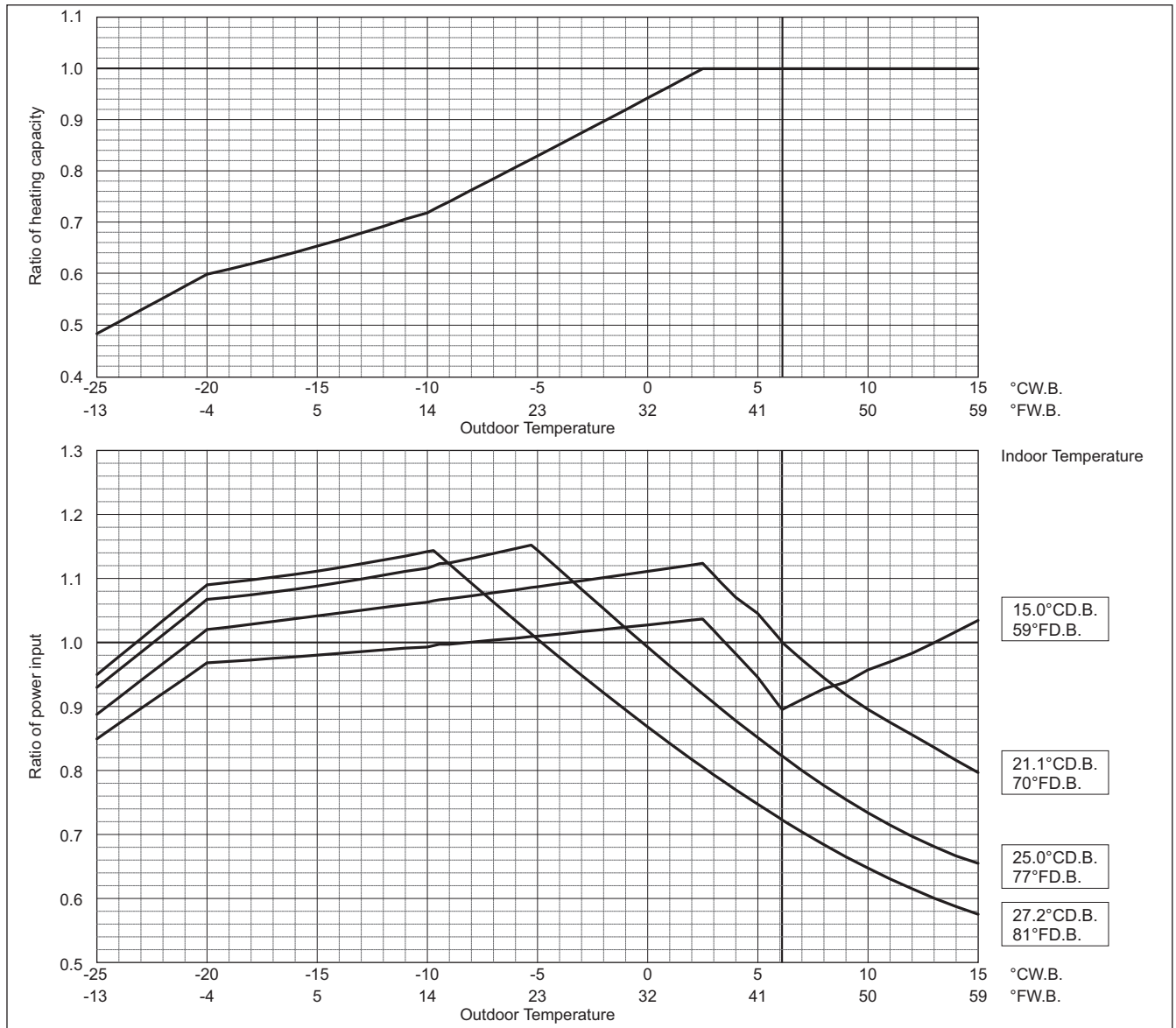

PURY-EP-T(S)NU-A, Y(S)NU-A

PURY-EP-T(S)NU-A, Y(S)NU-A

PURY-		EP96TNU/YNU	
		Non-Ducted	Ducted
Nominal cooling capacity	BTU/h	96,000	
	kW	28.1	
	Input kW	6.11	

Indoor unit temperature correction
To be used to correct indoor unit capacity only

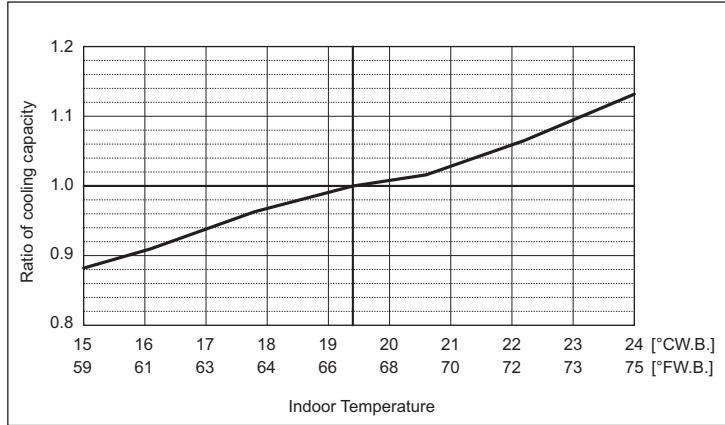

Outdoor unit temperature correction

To be used to correct outdoor unit only
Outdoor unit capacity is NOT affected by the indoor temperature.
Outdoor unit power input is affected by the indoor and outdoor temperatures. Please consult the sales office for details.

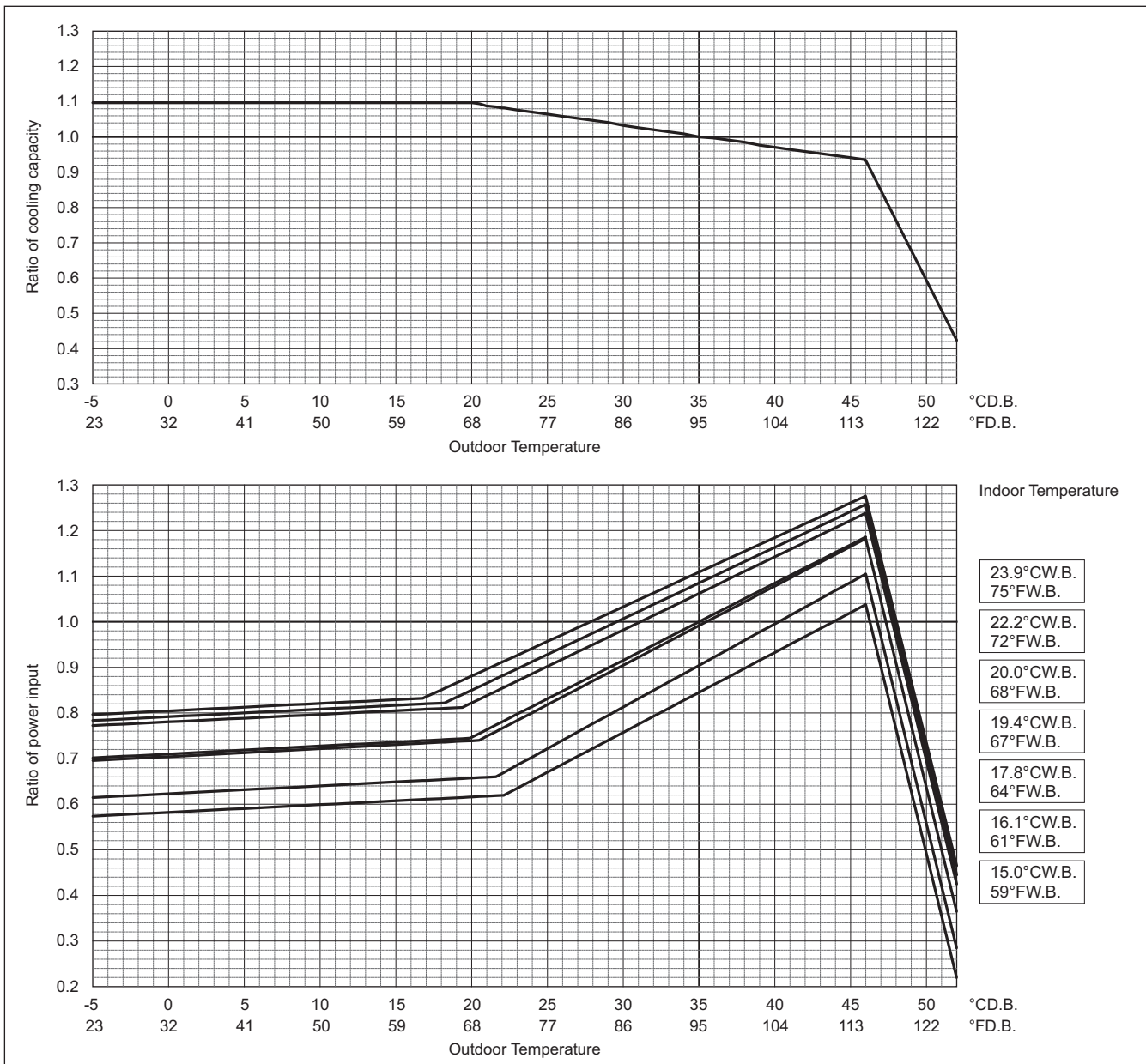

COP Priority Mode

PURY-		EP96TNU/YNU	
		Non-Ducted	Ducted
Nominal Heating capacity	BTU/h	108,000	
	kW	31.7	
	Input kW	7.40	

Indoor unit temperature correction

To be used to correct indoor unit capacity only

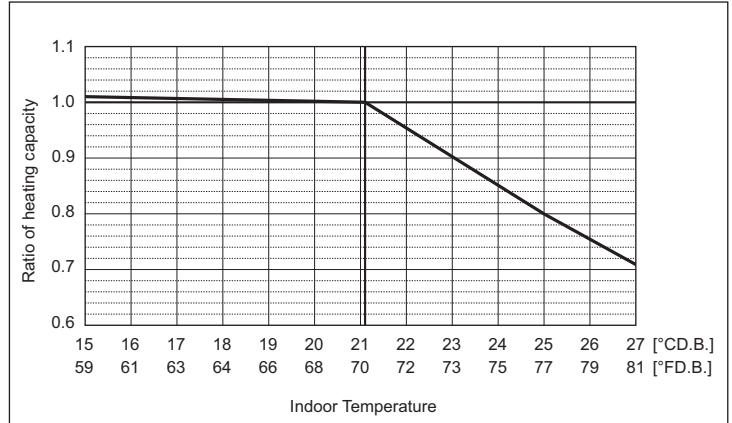

Outdoor unit temperature correction

To be used to correct outdoor unit only

Outdoor unit capacity is NOT affected by the indoor temperature.

Outdoor unit power input is affected by the indoor and outdoor temperatures. Please consult the sales office for details.

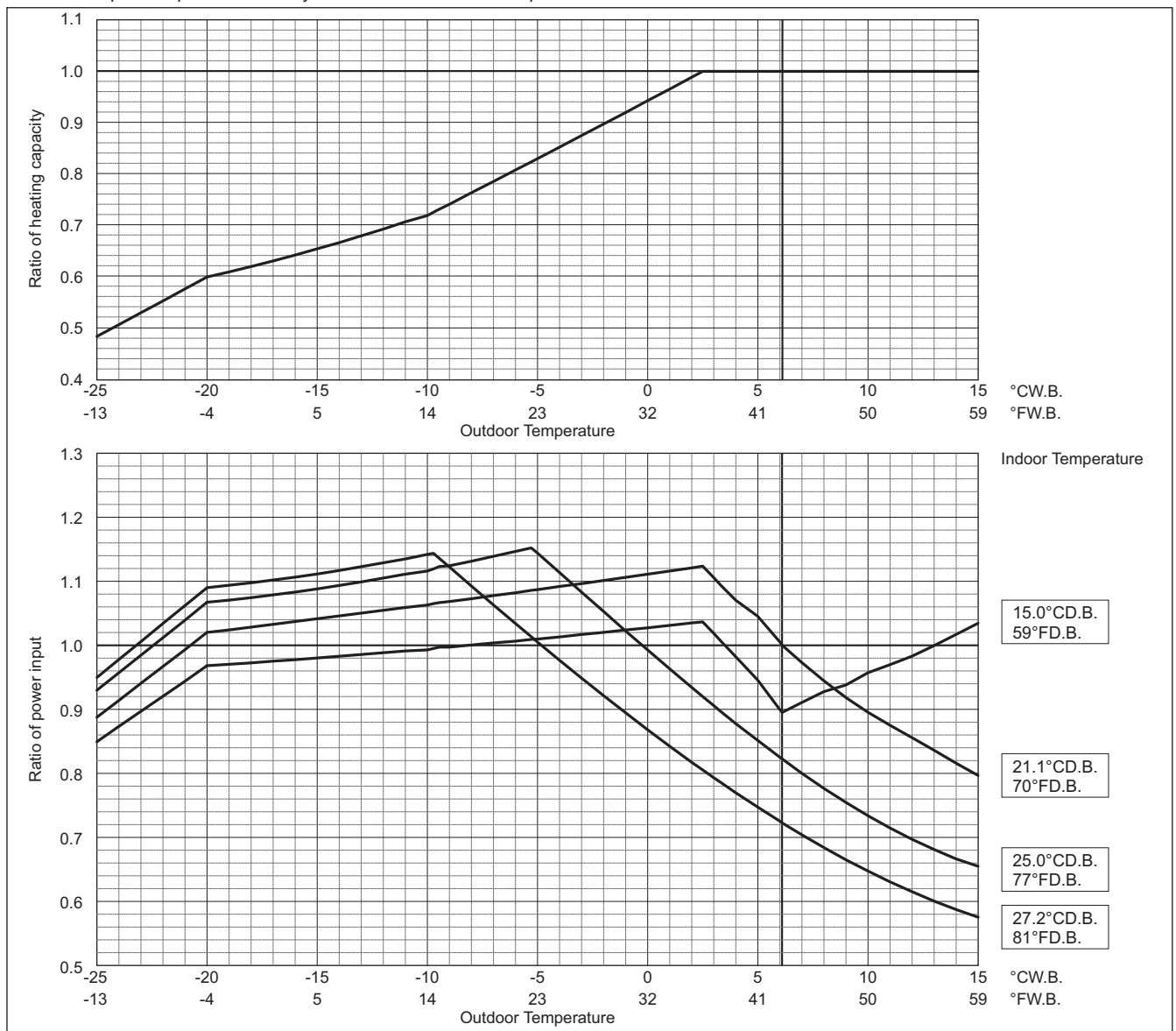

PURY-EP-T(S)NU-A, Y(S)NU-A

PURY-		EP120TNU/YNU	
		Non-Ducted	Ducted
Nominal cooling capacity	BTU/h	120,000	
	kW	35.2	
	Input kW	8.43	

Indoor unit temperature correction
To be used to correct indoor unit capacity only

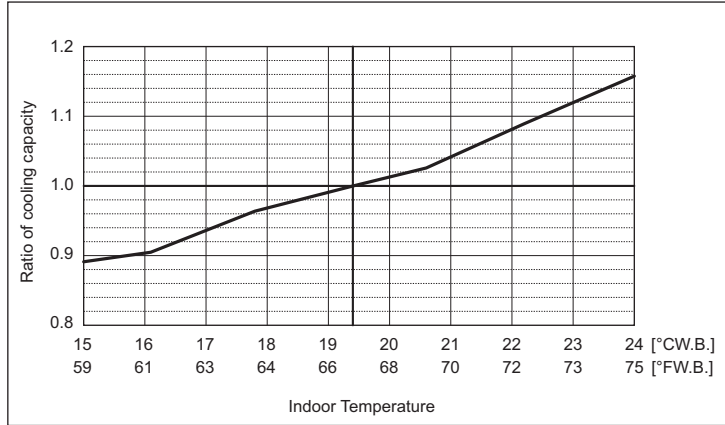

Outdoor unit temperature correction

To be used to correct outdoor unit only
Outdoor unit capacity is NOT affected by the indoor temperature.
Outdoor unit power input is affected by the indoor and outdoor temperatures. Please consult the sales office for details.

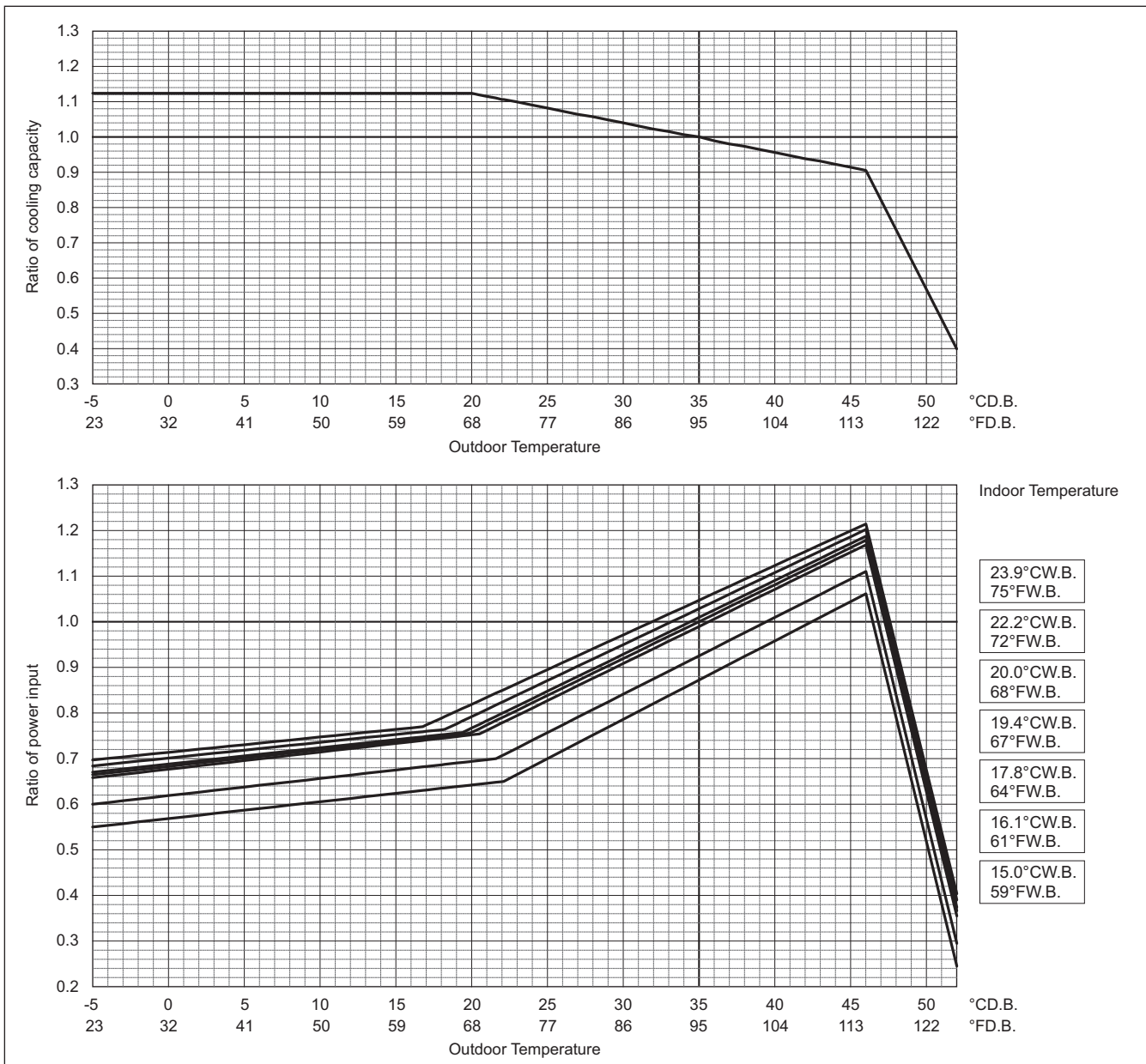

COP Priority Mode

PURY-		EP120TNU/YNU	
		Non-Ducted	Ducted
Nominal Heating capacity	BTU/h	135,000	
	kW	39.6	
	Input kW	9.89	

Indoor unit temperature correction

To be used to correct indoor unit capacity only

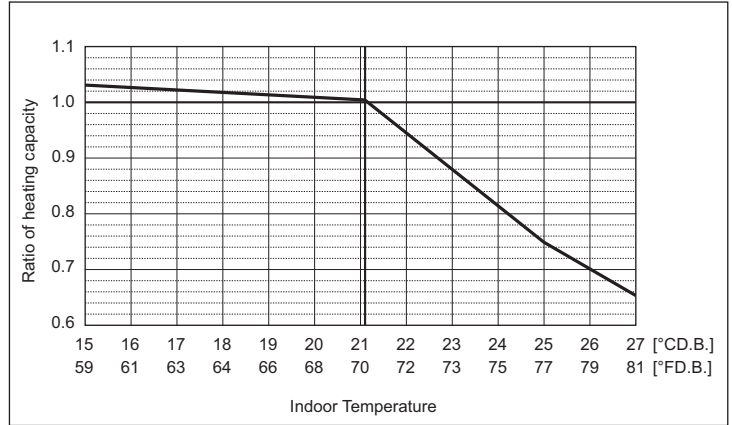

Outdoor unit temperature correction

To be used to correct outdoor unit only

Outdoor unit capacity is NOT affected by the indoor temperature.

Outdoor unit power input is affected by the indoor and outdoor temperatures. Please consult the sales office for details.

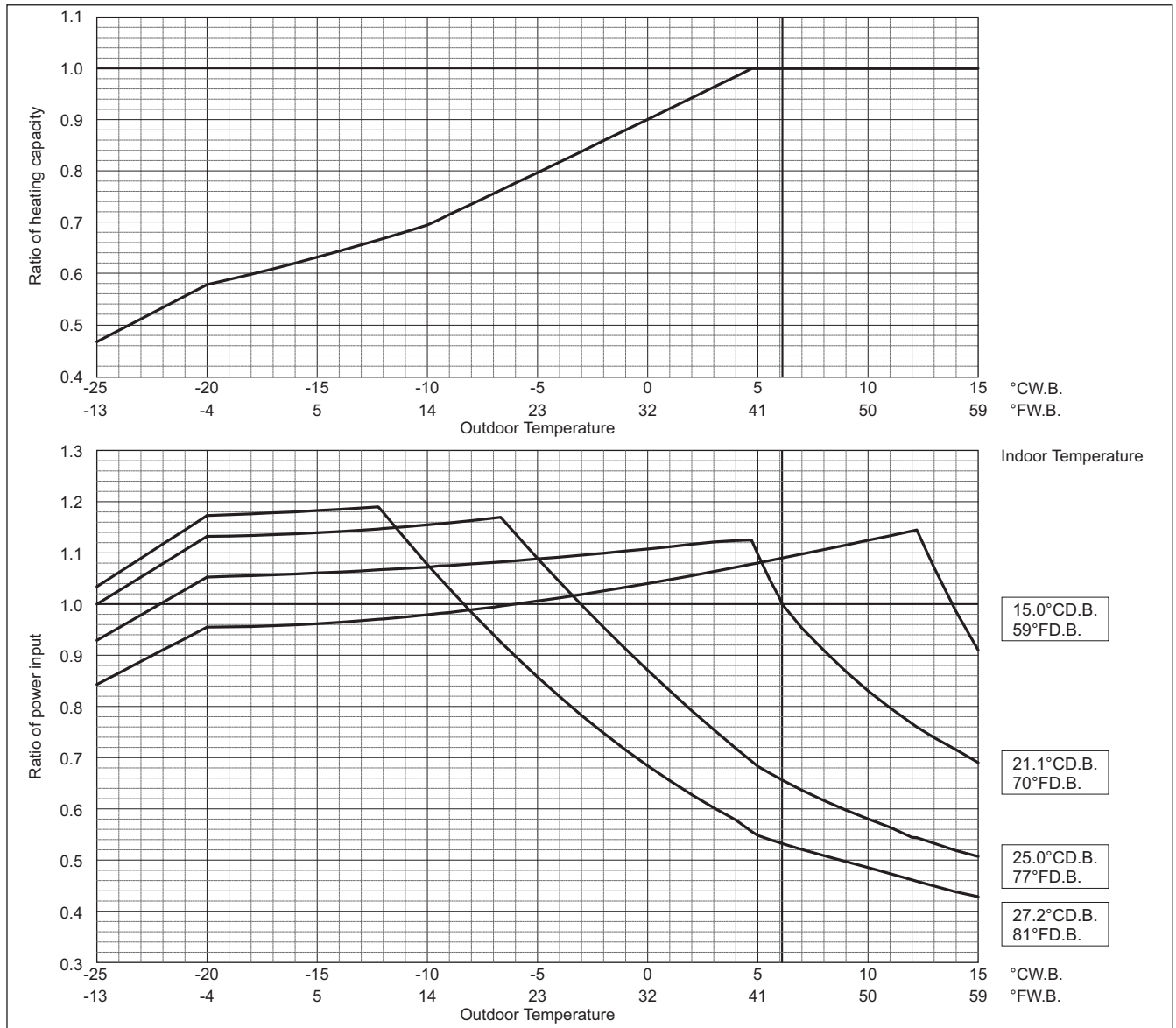

PURY-EP-T(S)NU-A, Y(S)NU-A

PURY-EP-T(S)NU-A, Y(S)NU-A

PURY-		EP144TNU/YNU	
		Non-Ducted	Ducted
Nominal cooling capacity	BTU/h	144,000	
	kW	42.2	
	Input kW	11.03	

Indoor unit temperature correction
To be used to correct indoor unit capacity only

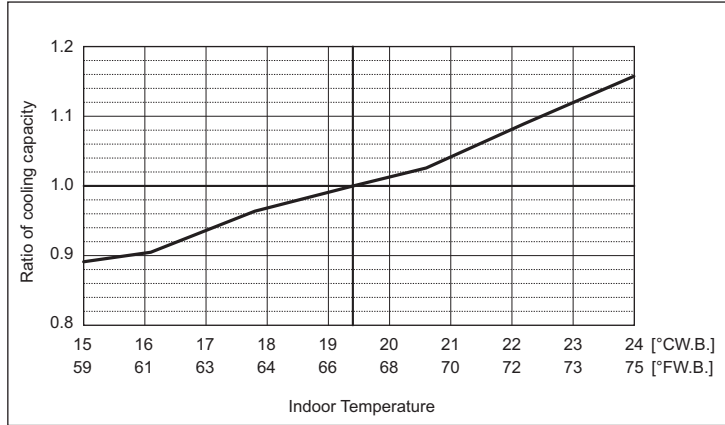

Outdoor unit temperature correction

To be used to correct outdoor unit only
Outdoor unit capacity is NOT affected by the indoor temperature.
Outdoor unit power input is affected by the indoor and outdoor temperatures. Please consult the sales office for details.

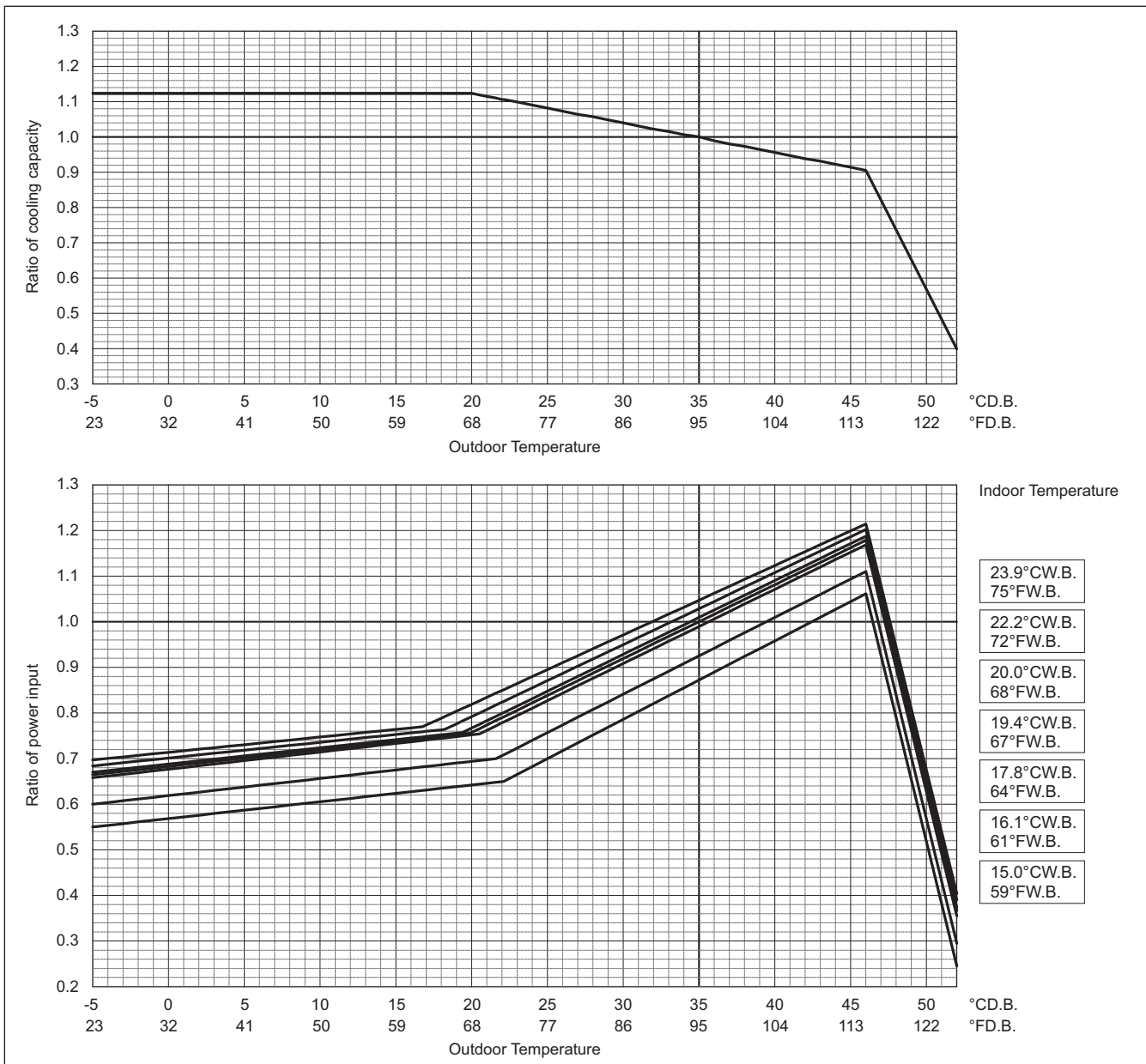

COP Priority Mode

PURY-		EP144TNU/YNU	
		Non-Ducted	Ducted
Nominal Heating capacity	BTU/h	160,000	
	kW	46.9	
	Input kW	12.34	

Indoor unit temperature correction

To be used to correct indoor unit capacity only

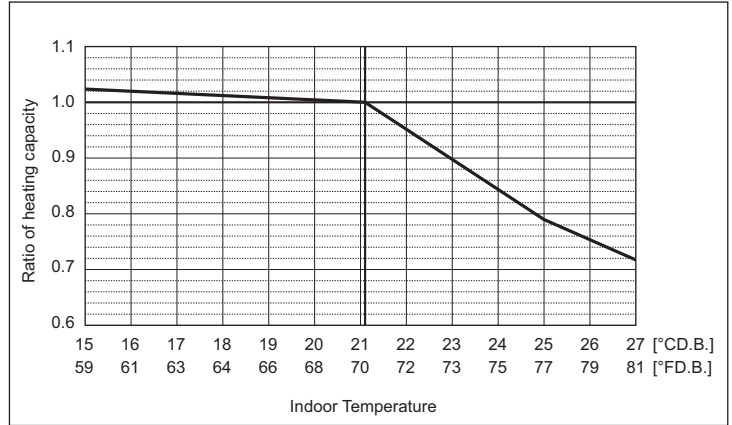

Outdoor unit temperature correction

To be used to correct outdoor unit only

Outdoor unit capacity is NOT affected by the indoor temperature.

Outdoor unit power input is affected by the indoor and outdoor temperatures. Please consult the sales office for details.

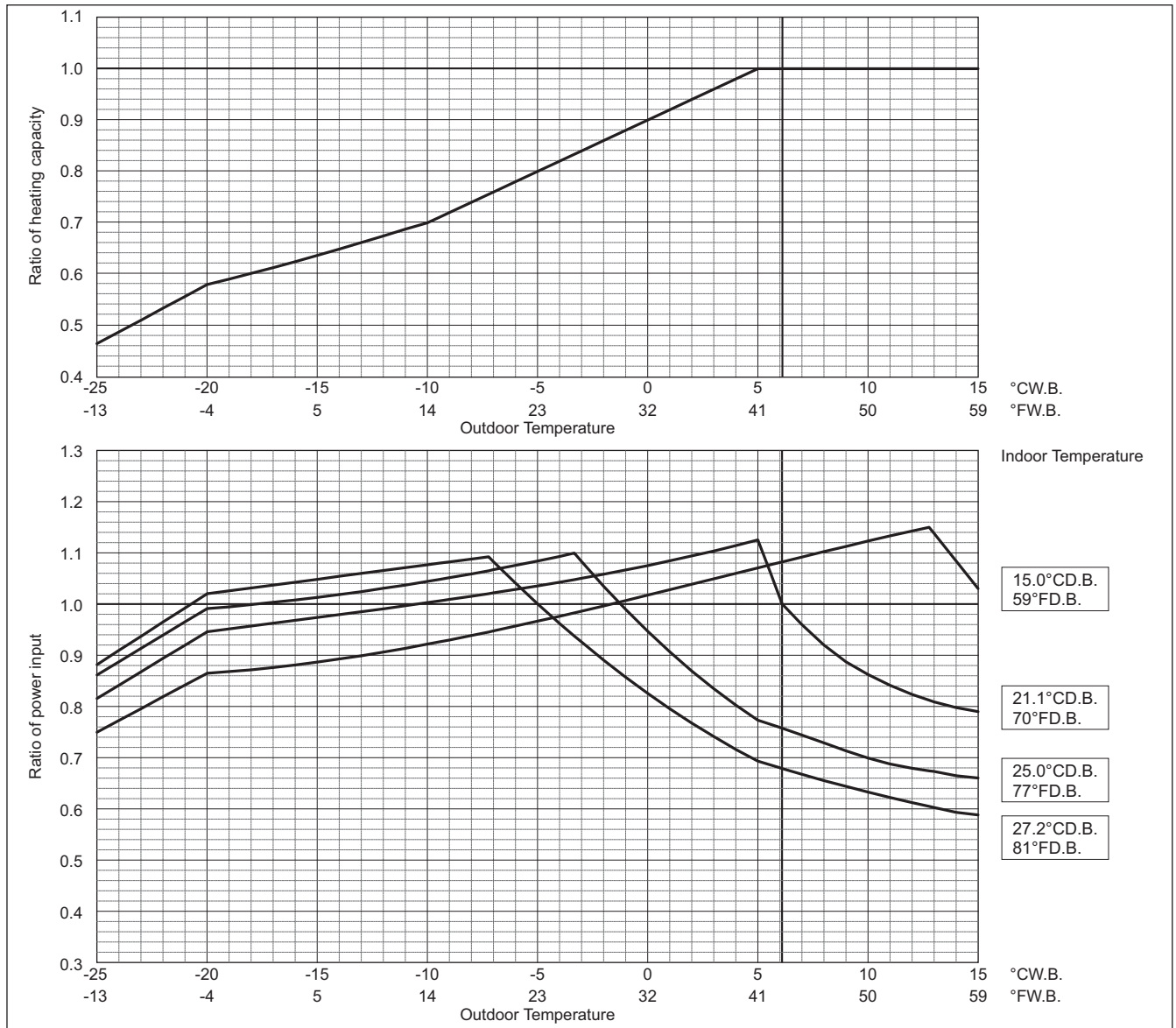

PURY-EP-T(S)NU-A, Y(S)NU-A

PURY-EP-T(S)NU-A, Y(S)NU-A

PURY-		EP168TNU/YNU	
		Non-Ducted	Ducted
Nominal cooling capacity	BTU/h	168,000	
	kW	49.2	
	Input kW	13.99	

Indoor unit temperature correction
To be used to correct indoor unit capacity only

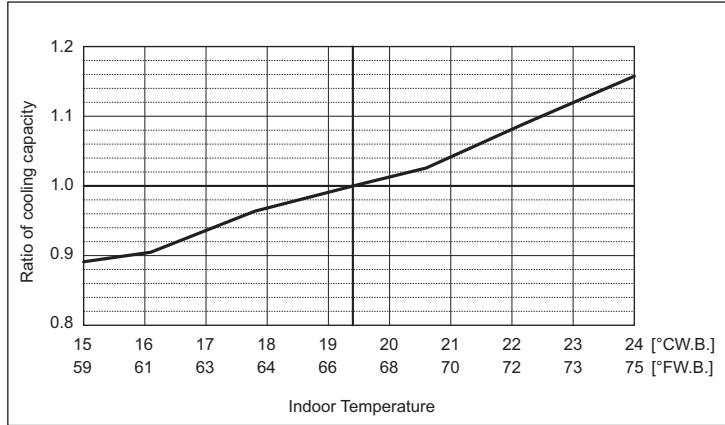

Outdoor unit temperature correction

To be used to correct outdoor unit only
Outdoor unit capacity is NOT affected by the indoor temperature.
Outdoor unit power input is affected by the indoor and outdoor temperatures. Please consult the sales office for details.

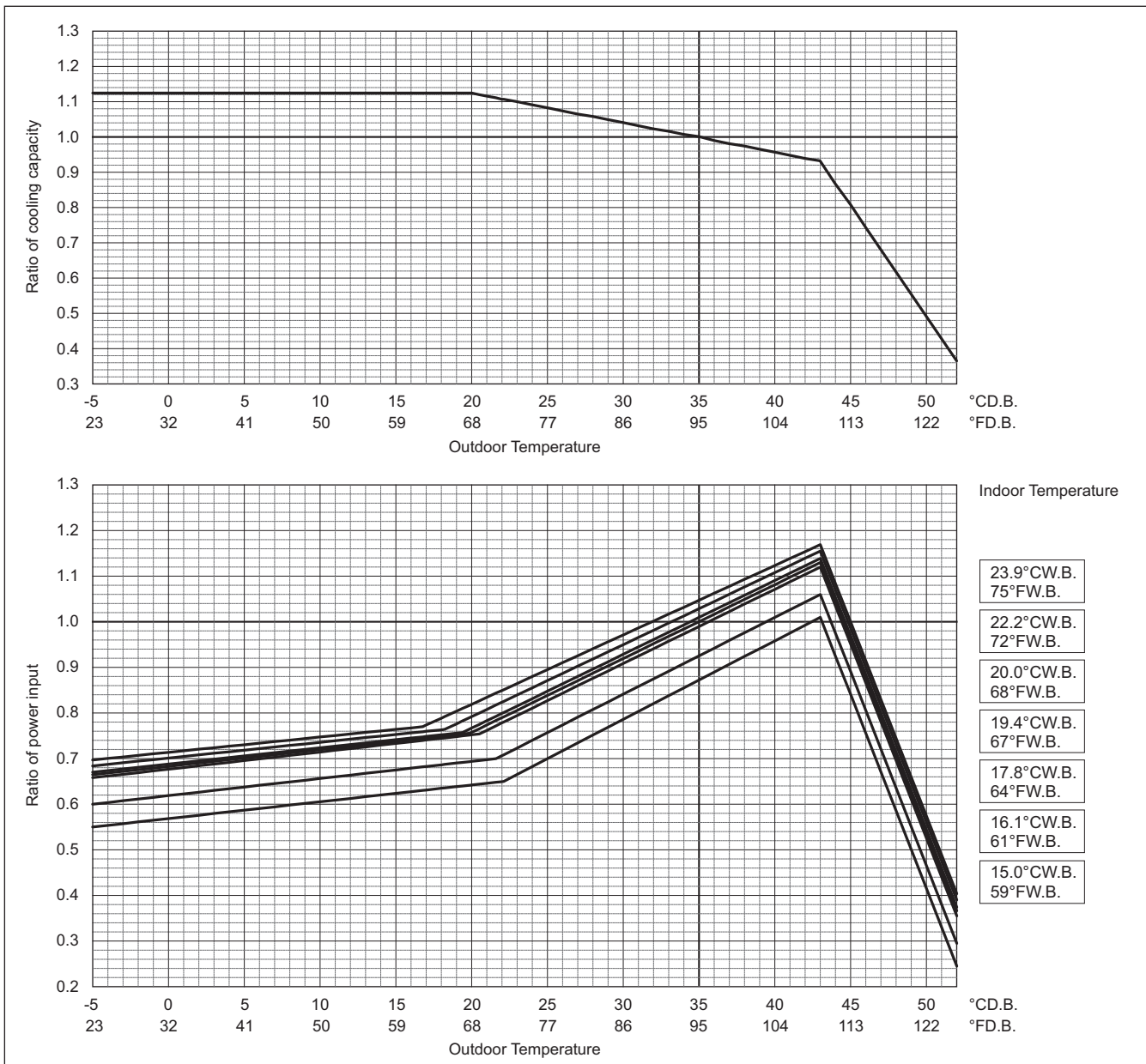

COP Priority Mode

PURY-		EP168TNU/YNU	
		Non-Ducted	Ducted
Nominal Heating capacity	BTU/h	188,000	
	kW	55.1	
	Input kW	15.17	

Indoor unit temperature correction

To be used to correct indoor unit capacity only

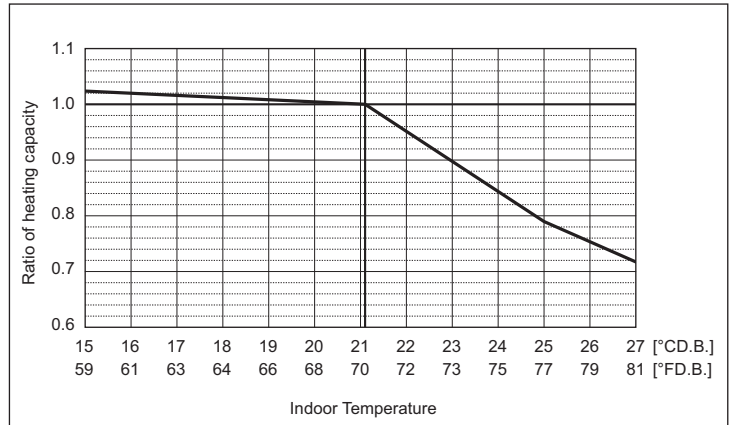

Outdoor unit temperature correction

To be used to correct outdoor unit only

Outdoor unit capacity is NOT affected by the indoor temperature.

Outdoor unit power input is affected by the indoor and outdoor temperatures. Please consult the sales office for details.

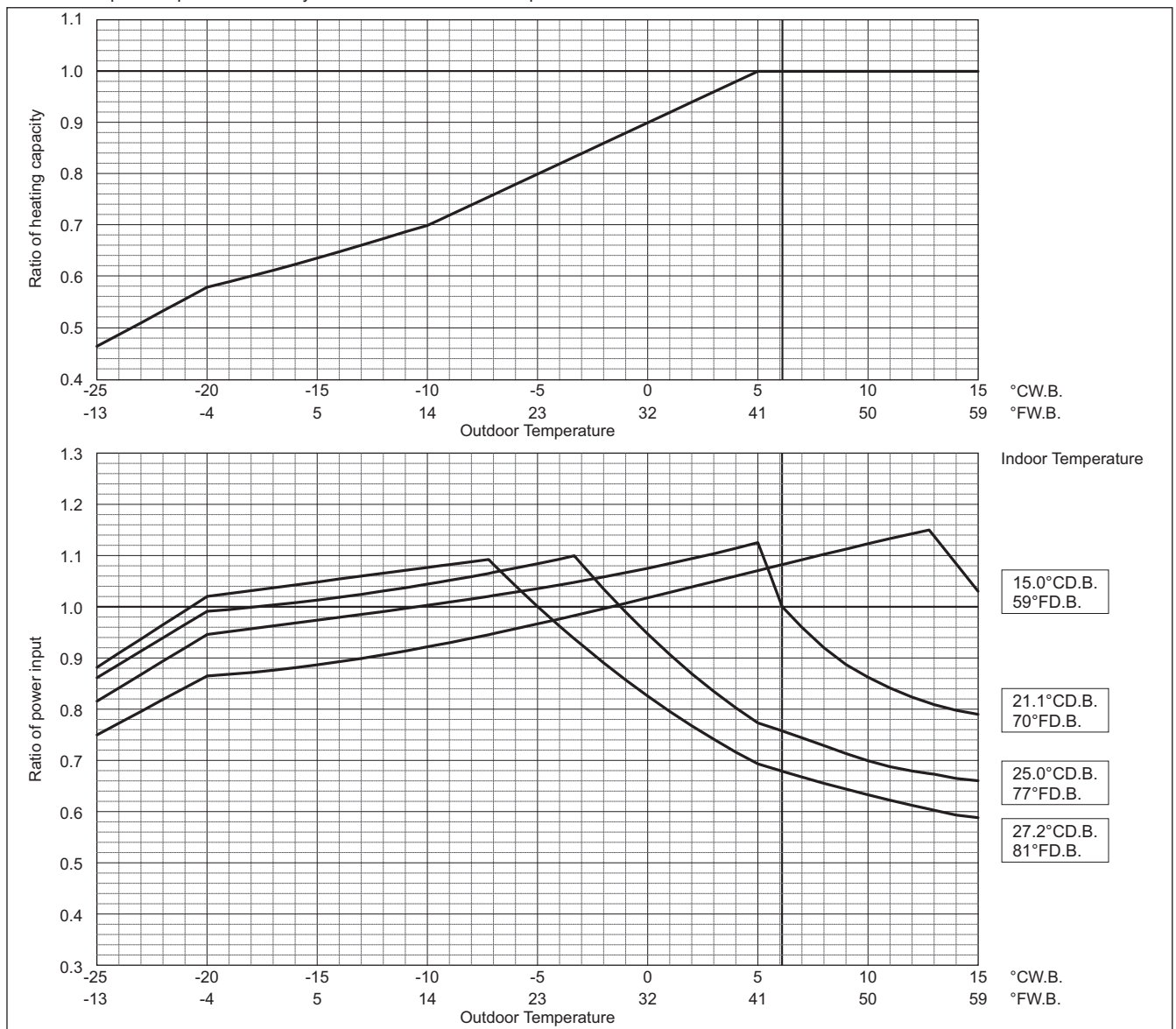

PURY-EP-T(S)NU-A, Y(S)NU-A

PURY-		EP192TNU/YNU	
		Non-Ducted	Ducted
Nominal cooling capacity	BTU/h	192,000	
	kW	56.3	
	Input kW	15.65	

Indoor unit temperature correction
To be used to correct indoor unit capacity only

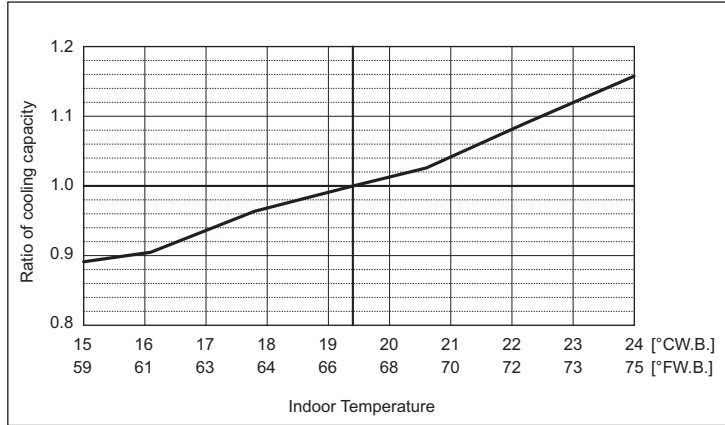

Outdoor unit temperature correction

To be used to correct outdoor unit only
Outdoor unit capacity is NOT affected by the indoor temperature.
Outdoor unit power input is affected by the indoor and outdoor temperatures. Please consult the sales office for details.

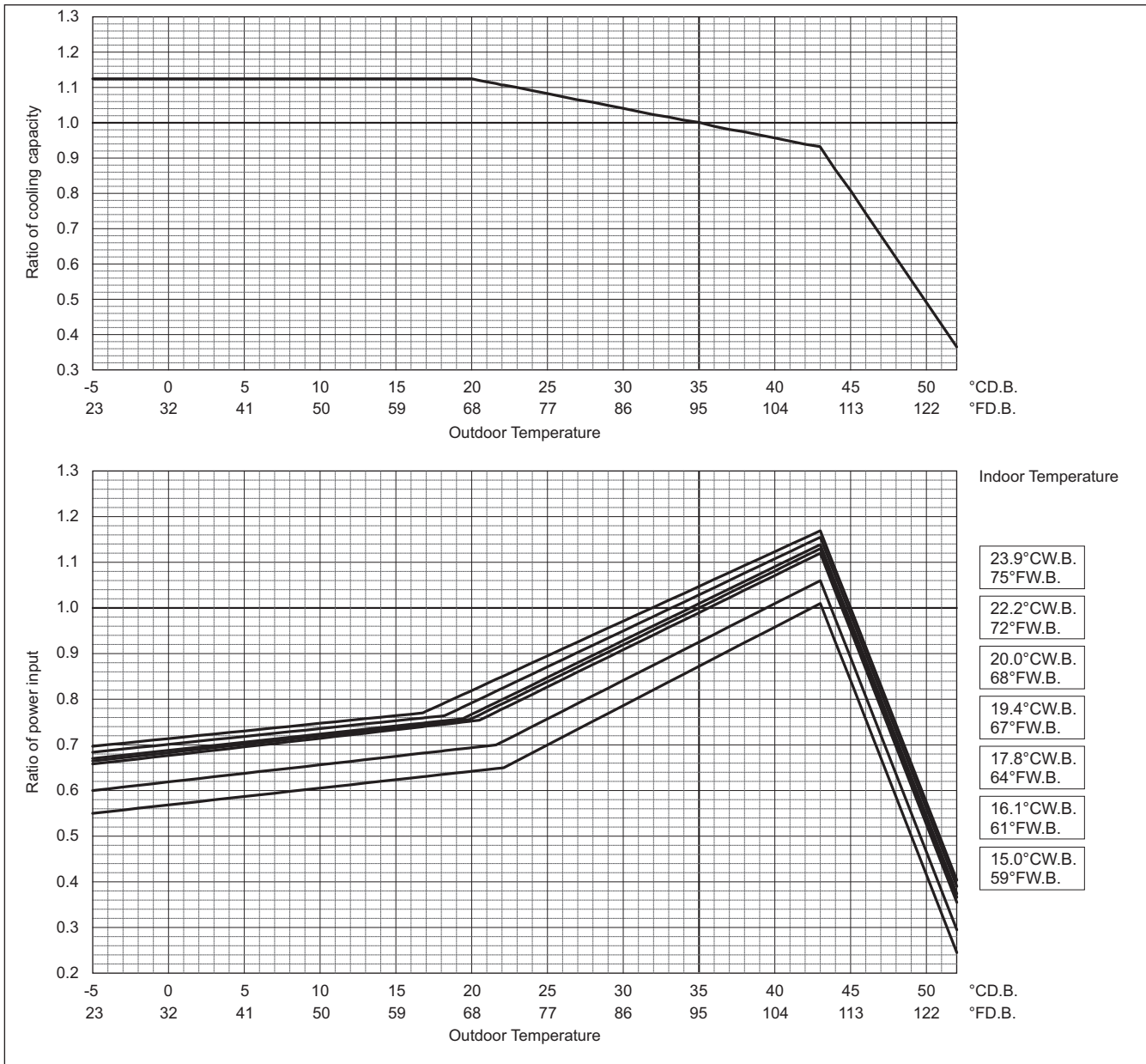

COP Priority Mode

PURY-		EP192TNU/YNU	
		Non-Ducted	Ducted
Nominal Heating capacity	BTU/h	215,000	
	kW	63.0	
	Input kW	17.54	

Indoor unit temperature correction

To be used to correct indoor unit capacity only

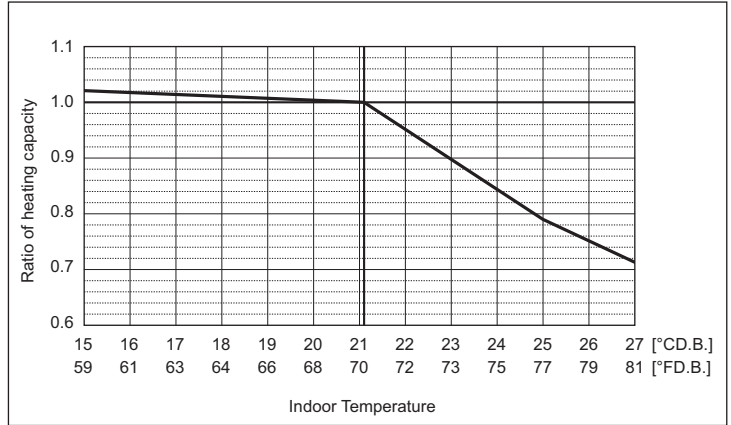

Outdoor unit temperature correction

To be used to correct outdoor unit only

Outdoor unit capacity is NOT affected by the indoor temperature.

Outdoor unit power input is affected by the indoor and outdoor temperatures. Please consult the sales office for details.

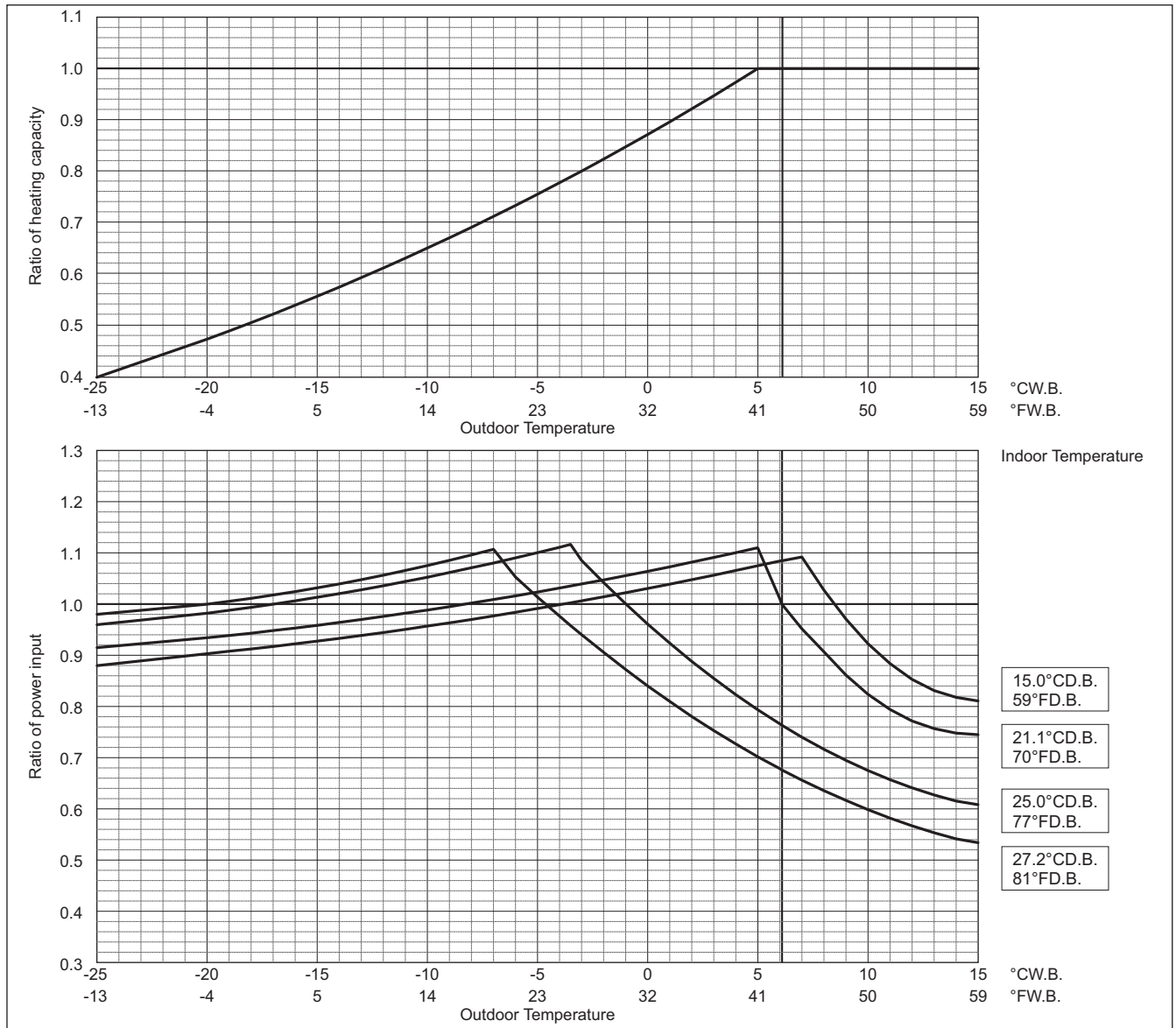

PURY-EP-T(S)NU-A, Y(S)NU-A

PURY-EP-T(S)NU-A, Y(S)NU-A

PURY-		EP216TNU/YNU	
		Non-Ducted	Ducted
Nominal cooling capacity	BTU/h	216,000	
	kW	63.3	
	Input kW	18.66	

Indoor unit temperature correction
To be used to correct indoor unit capacity only

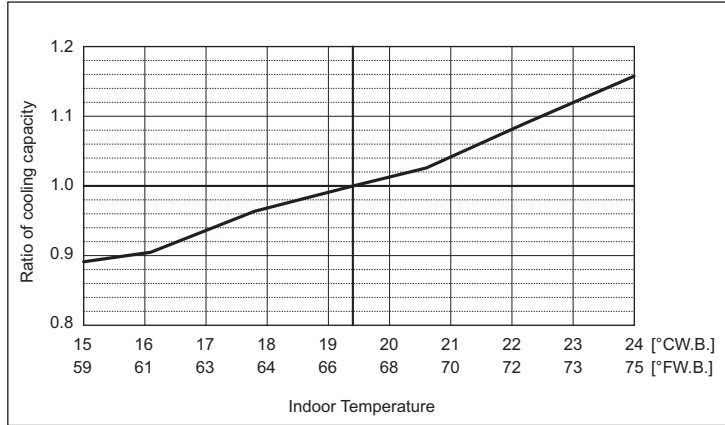

Outdoor unit temperature correction

To be used to correct outdoor unit only
Outdoor unit capacity is NOT affected by the indoor temperature.
Outdoor unit power input is affected by the indoor and outdoor temperatures. Please consult the sales office for details.

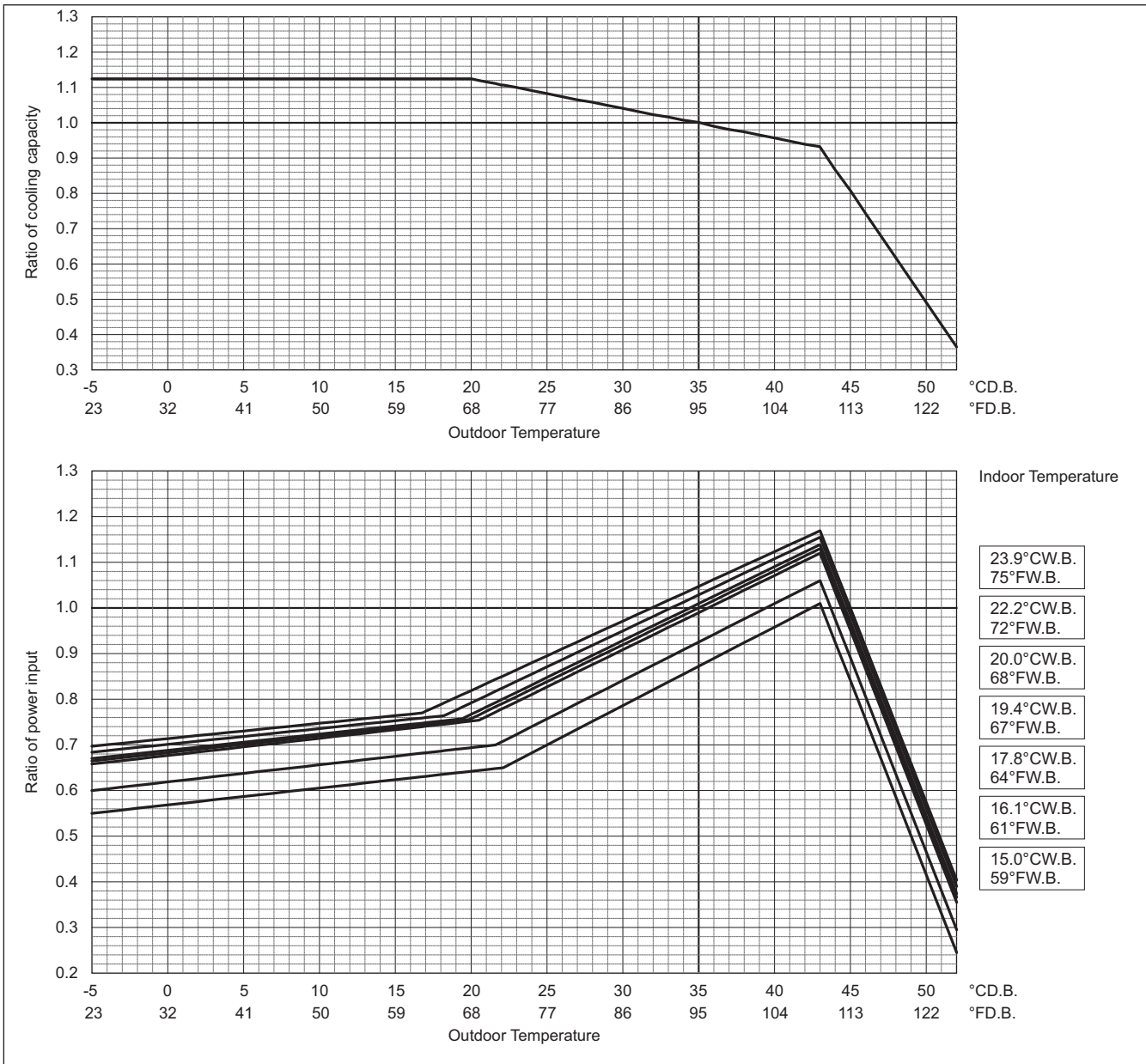

COP Priority Mode

PURY-		EP216TNU/YNU	
		Non-Ducted	Ducted
Nominal Heating capacity	BTU/h	243,000	
	kW	71.2	
	Input kW	20.43	

Indoor unit temperature correction

To be used to correct indoor unit capacity only

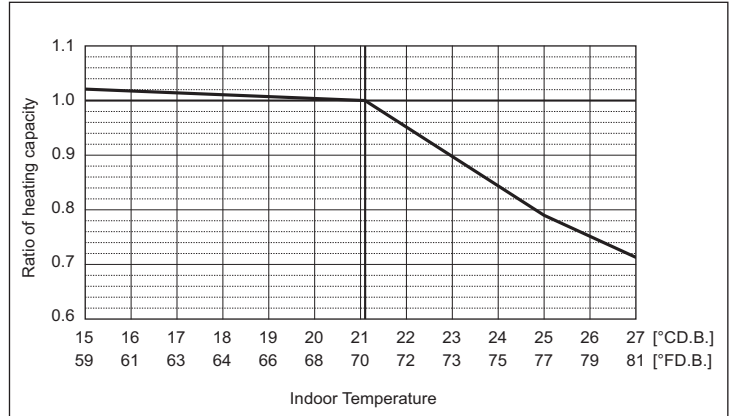

Outdoor unit temperature correction

To be used to correct outdoor unit only

Outdoor unit capacity is NOT affected by the indoor temperature.

Outdoor unit power input is affected by the indoor and outdoor temperatures. Please consult the sales office for details.

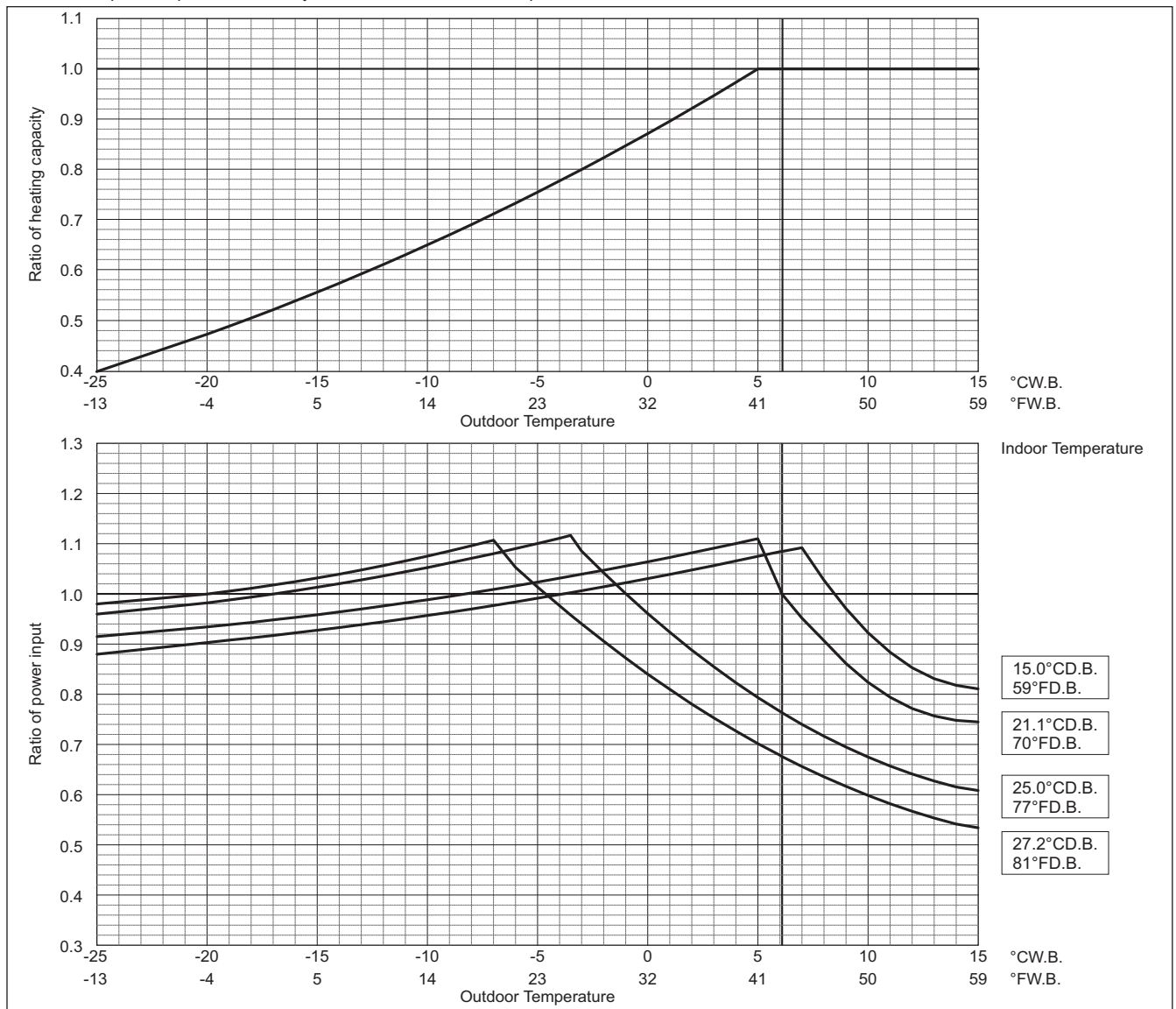

PURY-EP-T(S)NU-A, Y(S)NU-A

PURY-		EP240TNU/YNU	
		Non-Ducted	Ducted
Nominal cooling capacity	BTU/h	224,000	
	kW	65.7	
	Input kW	21.39	

Indoor unit temperature correction
To be used to correct indoor unit capacity only

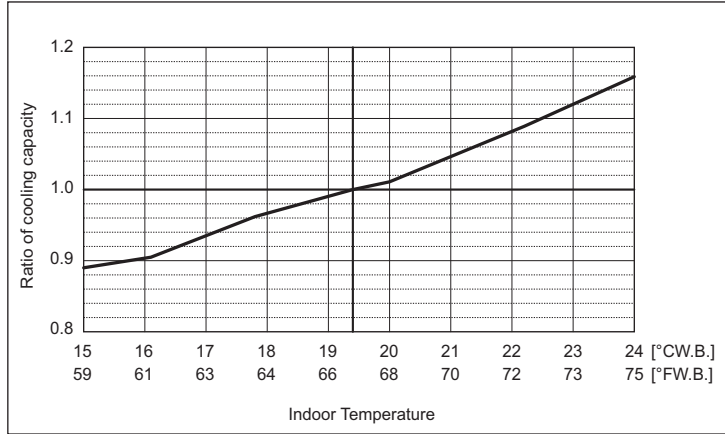

Outdoor unit temperature correction

To be used to correct outdoor unit only

Outdoor unit capacity is NOT affected by the indoor temperature.

Outdoor unit power input is affected by the indoor and outdoor temperatures. Please consult the sales office for details.

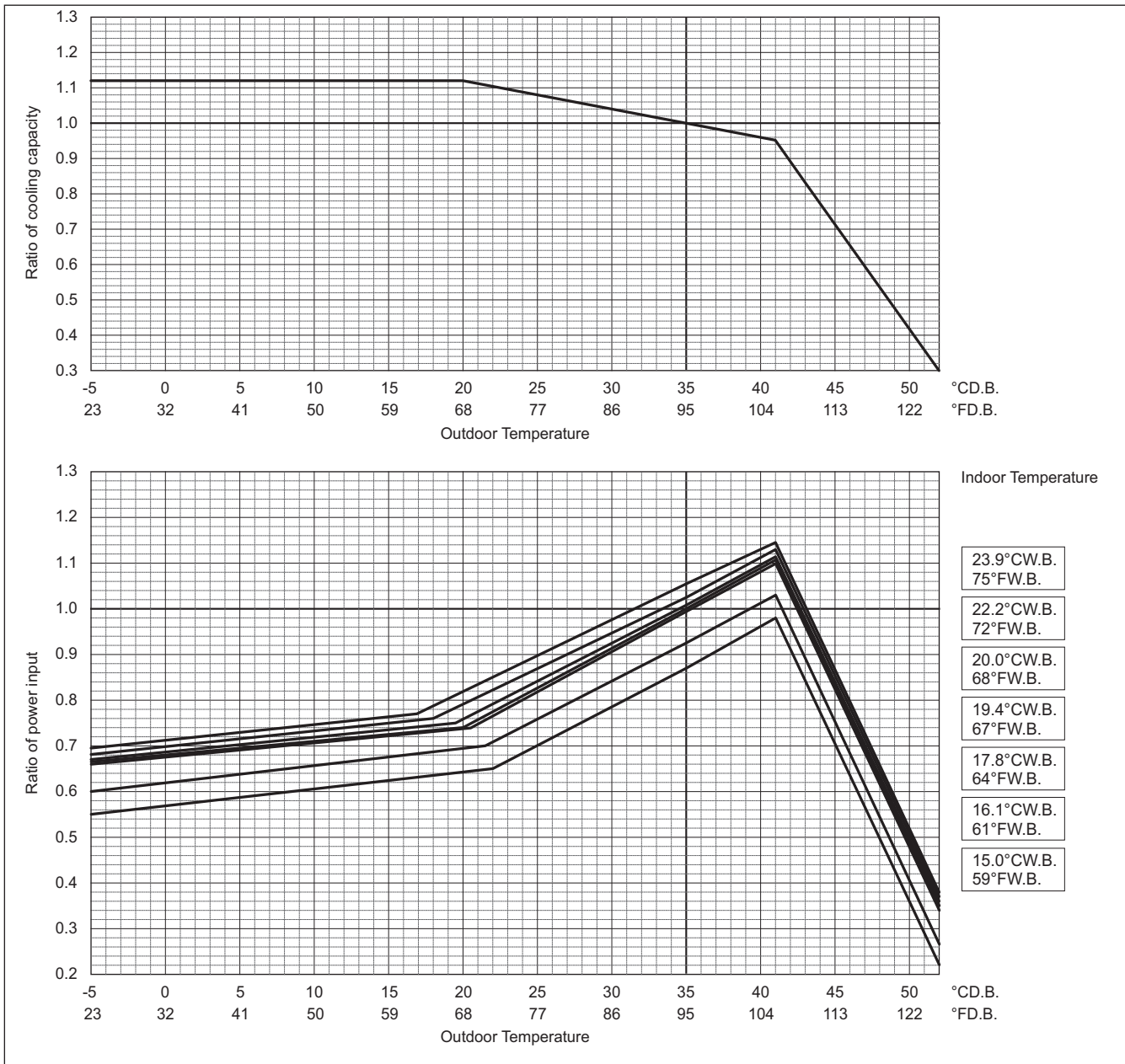

COP Priority Mode

PURY-		EP240TNU/YNU	
		Non-Ducted	Ducted
Nominal Heating capacity	BTU/h	250,000	
	kW	73.3	
	Input kW	21.79	

Indoor unit temperature correction

To be used to correct indoor unit capacity only

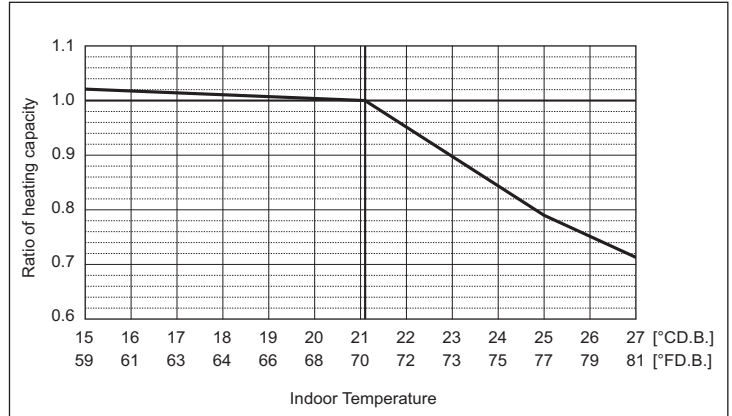

Outdoor unit temperature correction

To be used to correct outdoor unit only

Outdoor unit capacity is NOT affected by the indoor temperature.

Outdoor unit power input is affected by the indoor and outdoor temperatures. Please consult the sales office for details.

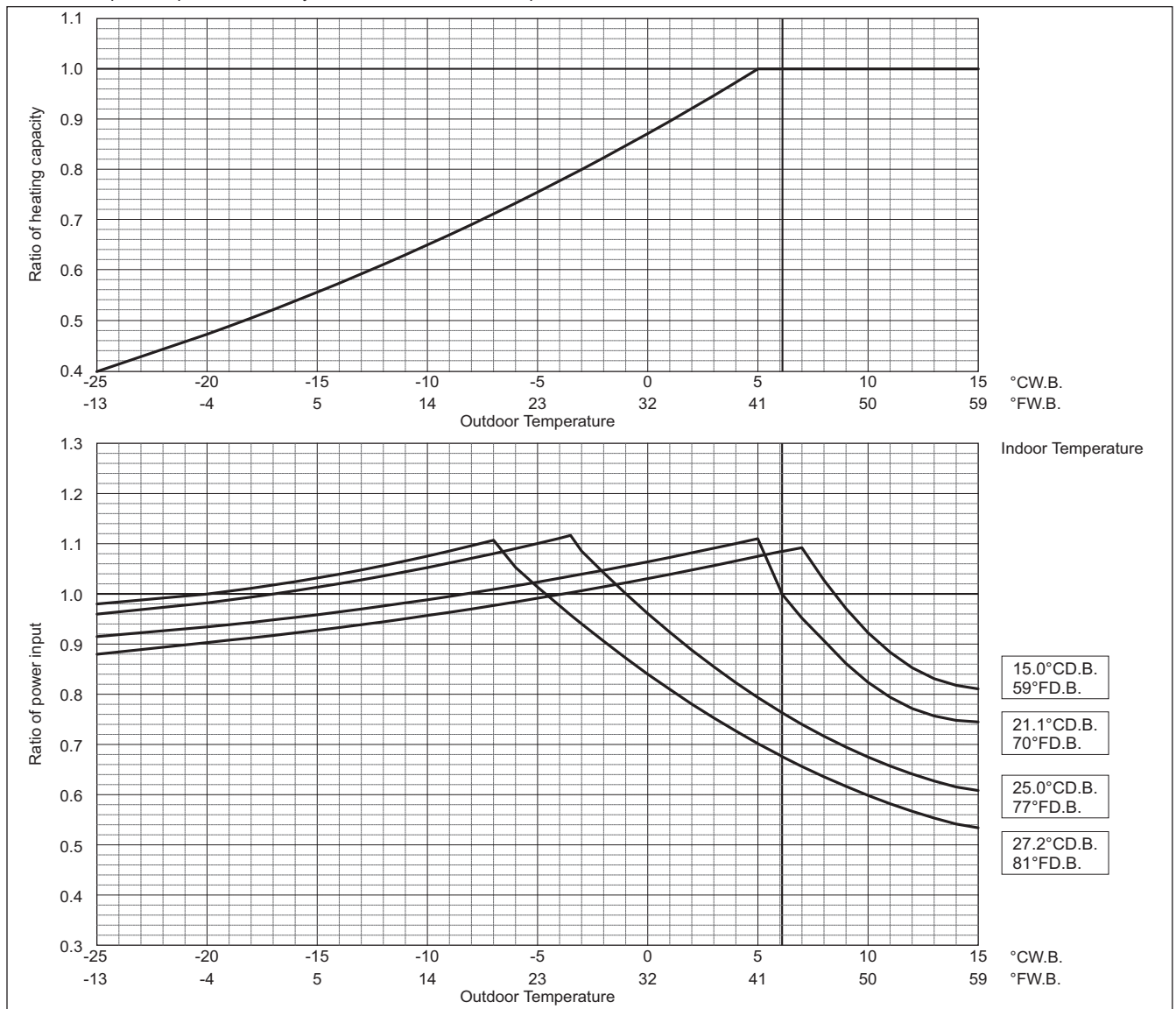

PURY-EP-T(S)NU-A, Y(S)NU-A

PURY-		EP192TSNU/YSNU	
		Non-Ducted	Ducted
Nominal cooling capacity	BTU/h	192,000	
	kW	56.3	
	Input kW	13.60	

Indoor unit temperature correction
To be used to correct indoor unit capacity only

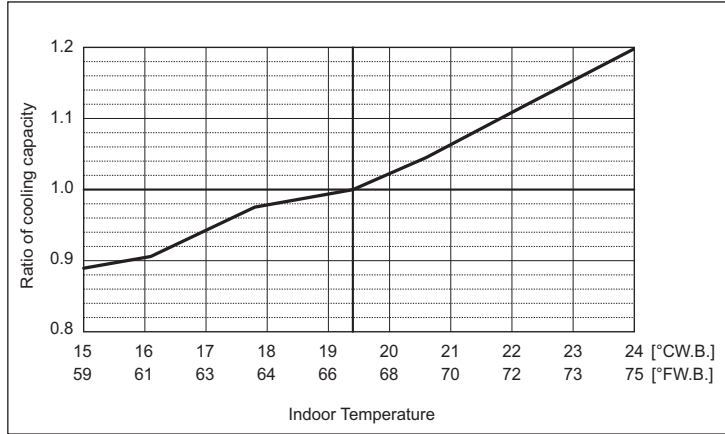

Outdoor unit temperature correction

To be used to correct outdoor unit only

Outdoor unit capacity is NOT affected by the indoor temperature.

Outdoor unit power input is affected by the indoor and outdoor temperatures. Please consult the sales office for details.

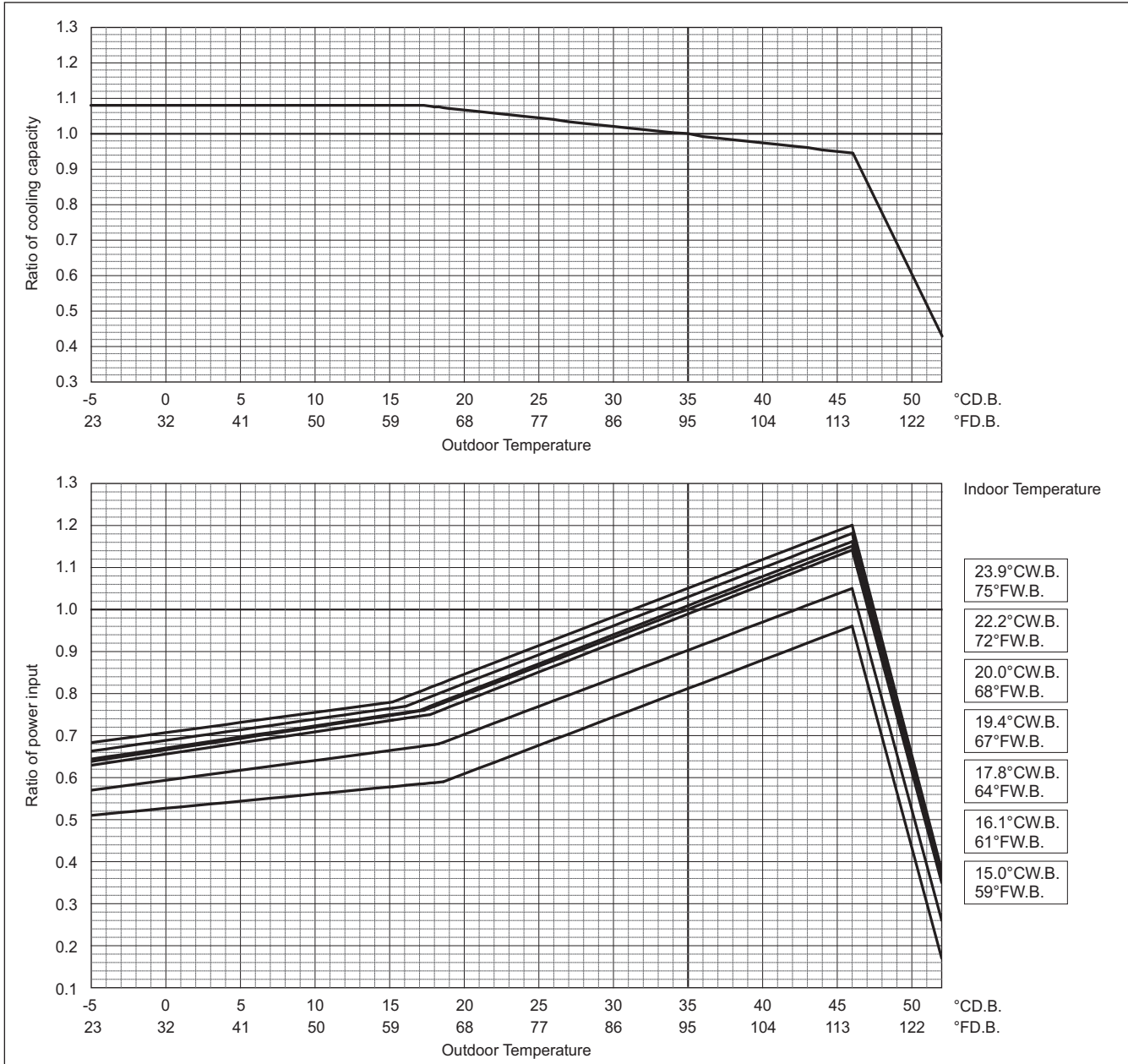

COP Priority Mode

PURY-		EP192TSNU/YSNU	
		Non-Ducted	Ducted
Nominal Heating capacity	BTU/h	215,000	
	kW	63.0	
	Input kW	16.02	

Indoor unit temperature correction

To be used to correct indoor unit capacity only

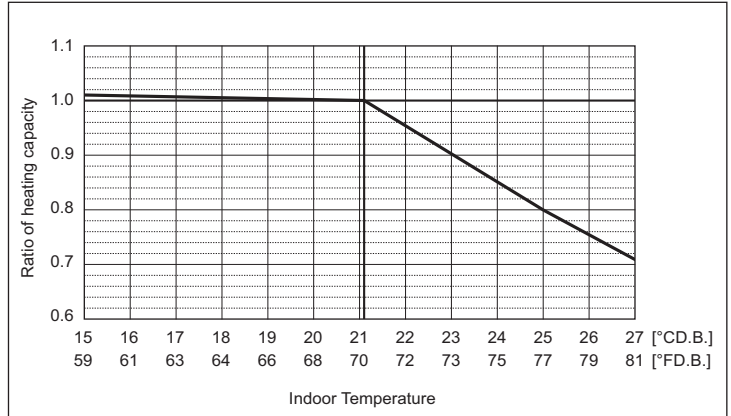

Outdoor unit temperature correction

To be used to correct outdoor unit only

Outdoor unit capacity is NOT affected by the indoor temperature.

Outdoor unit power input is affected by the indoor and outdoor temperatures. Please consult the sales office for details.

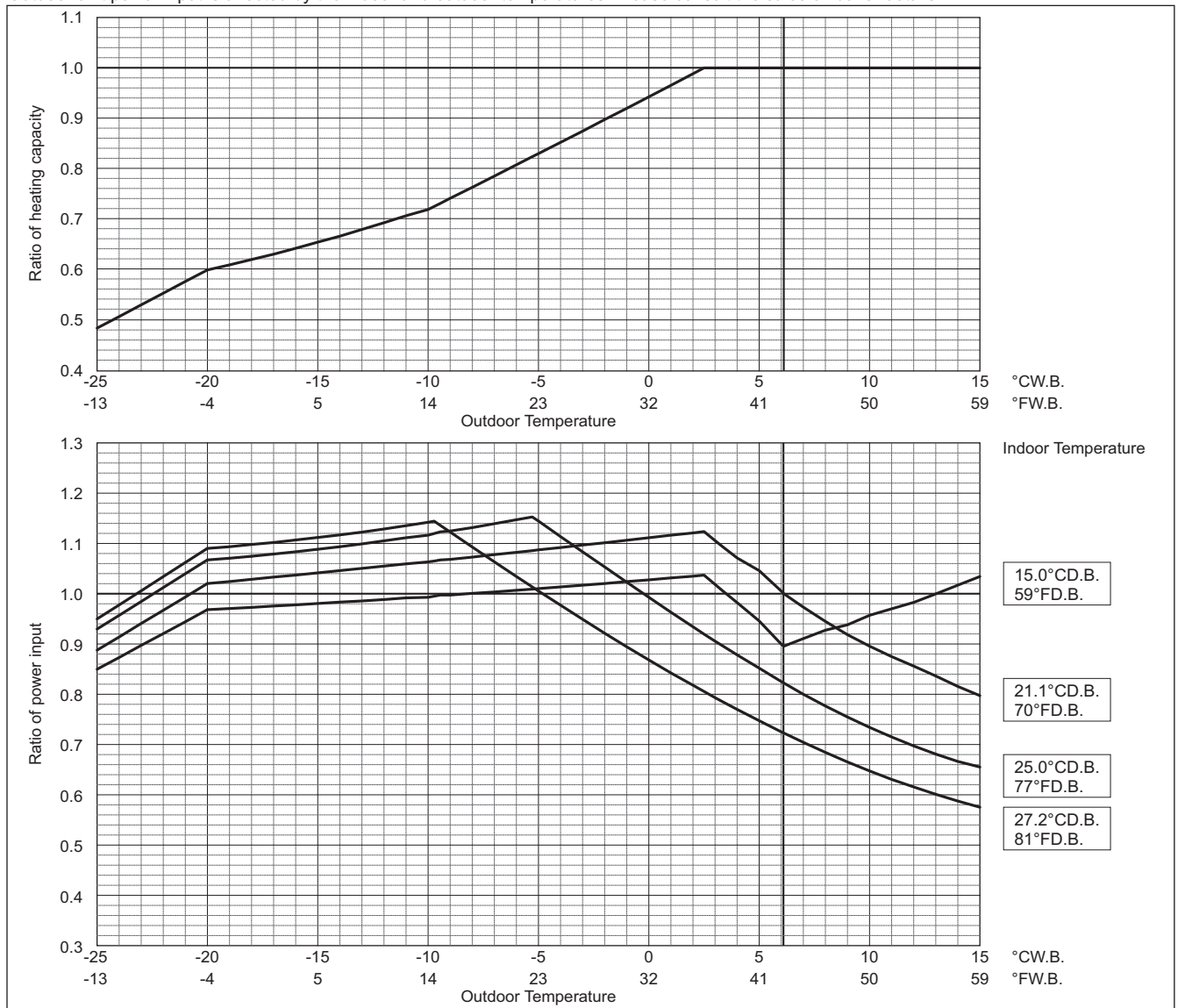

PURY-EP-T(S)NU-A, Y(S)NU-A

PURY-	EP216TSNU/YSNU		EP240TSNU/YSNU	
	Non-Ducted	Ducted	Non-Ducted	Ducted
Nominal cooling capacity	216,000		240,000	
	kW		70.3	
Input	kW		19.17	

Indoor unit temperature correction
To be used to correct indoor unit capacity only

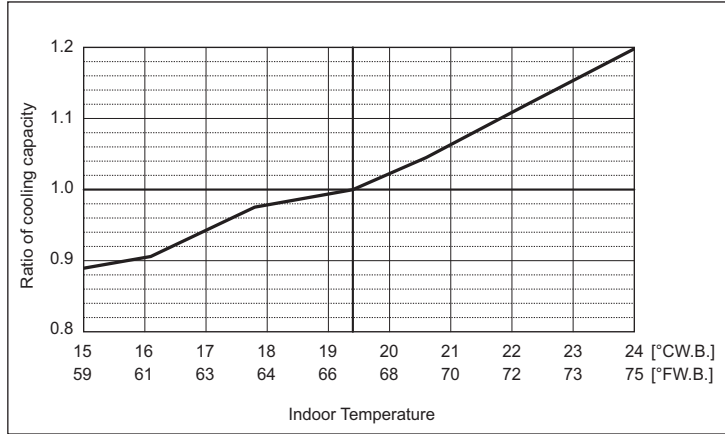

Outdoor unit temperature correction

To be used to correct outdoor unit only

Outdoor unit capacity is NOT affected by the indoor temperature.

Outdoor unit power input is affected by the indoor and outdoor temperatures. Please consult the sales office for details.

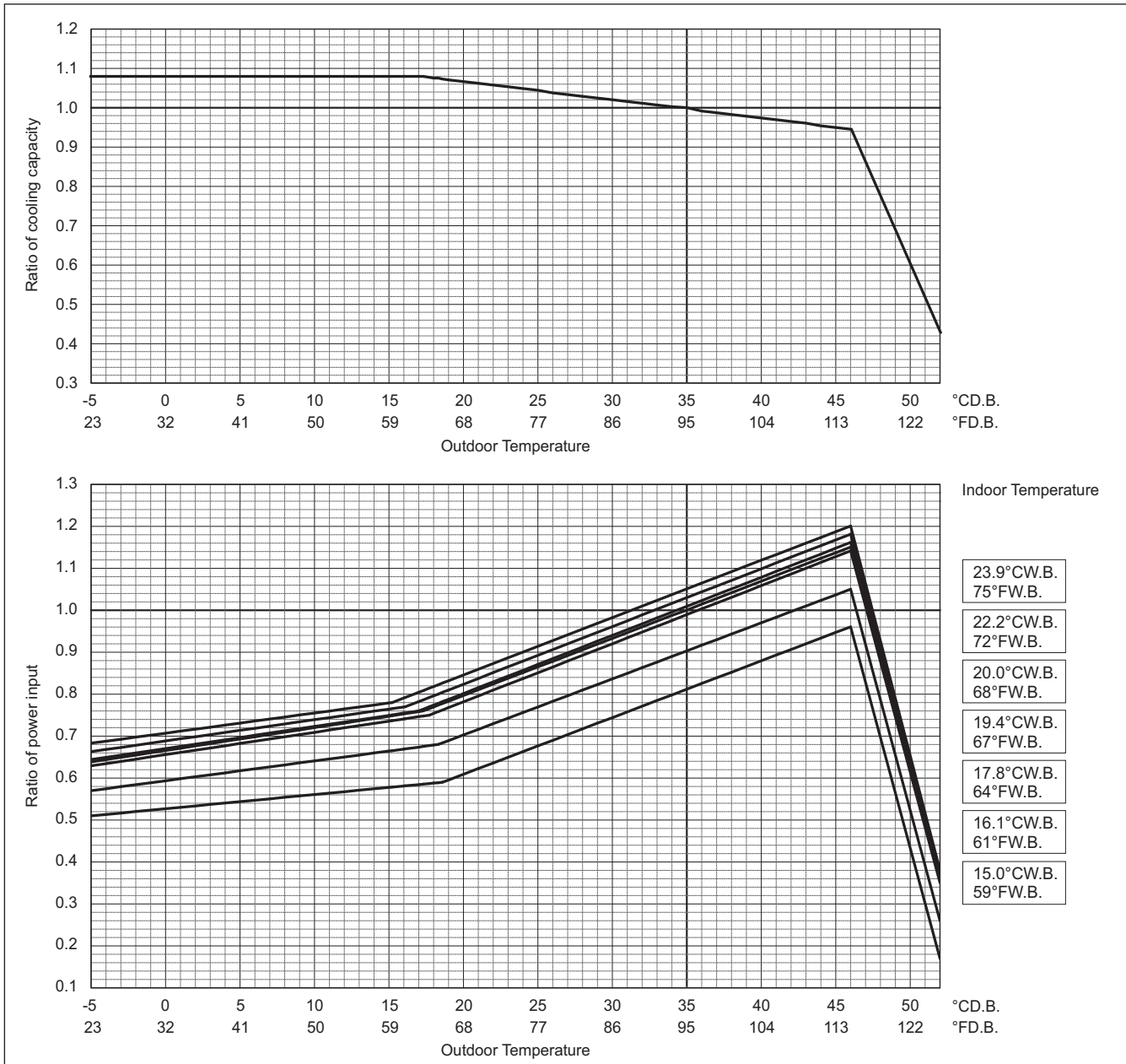

COP Priority Mode

PURY-		EP216TSNU/YSNU		EP240TSNU/YSNU	
		Non-Ducted	Ducted	Non-Ducted	Ducted
Nominal Heating capacity	BTU/h	243,000		270,000	
	kW	71.2		79.1	
	Input kW	18.67		22.03	

Indoor unit temperature correction

To be used to correct indoor unit capacity only

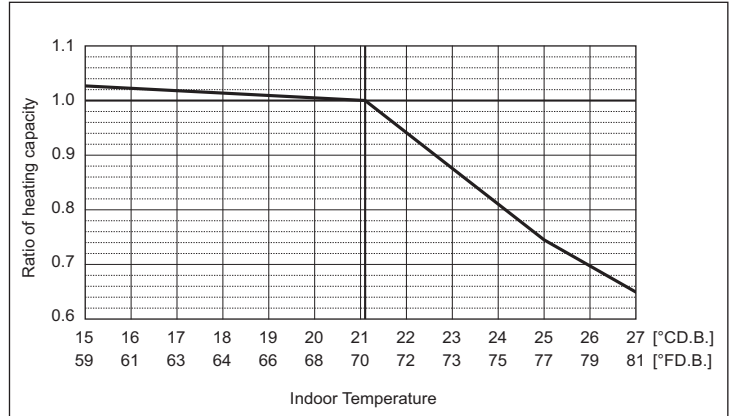

Outdoor unit temperature correction

To be used to correct outdoor unit only

Outdoor unit capacity is NOT affected by the indoor temperature.

Outdoor unit power input is affected by the indoor and outdoor temperatures. Please consult the sales office for details.

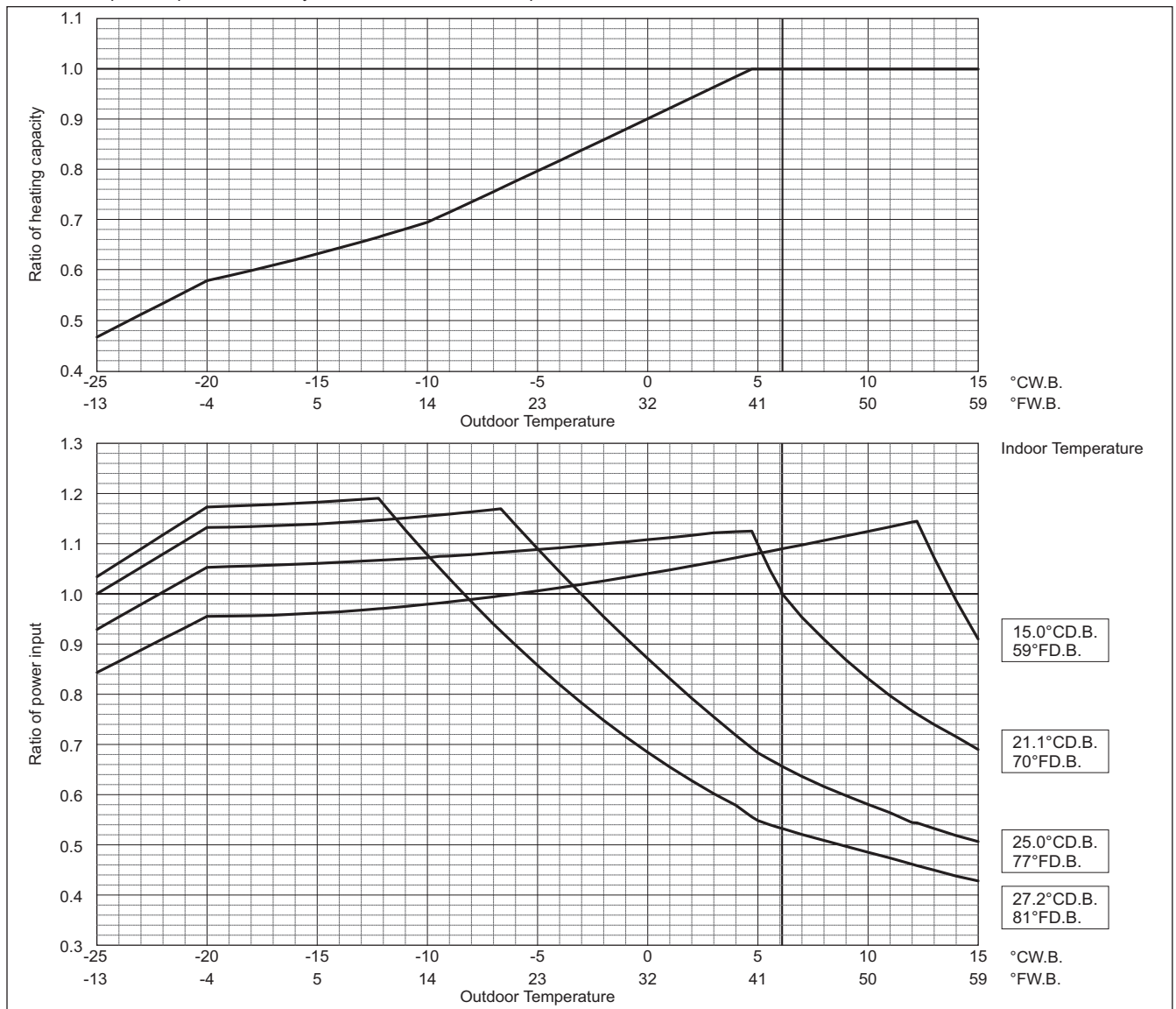

PURY-EP-T(S)NU-A, Y(S)NU-A

PURY-EP-T(S)NU-A, Y(S)NU-A

PURY-		EP264TSNU/YSNU	
		Non-Ducted	Ducted
Nominal cooling capacity	BTU/h	264,000	
	kW	77.4	
	Input kW	21.86	

Indoor unit temperature correction
To be used to correct indoor unit capacity only

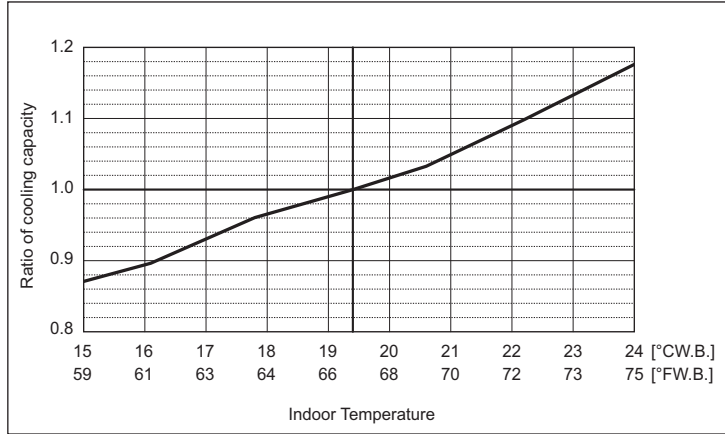

Outdoor unit temperature correction

To be used to correct outdoor unit only

Outdoor unit capacity is NOT affected by the indoor temperature.

Outdoor unit power input is affected by the indoor and outdoor temperatures. Please consult the sales office for details.

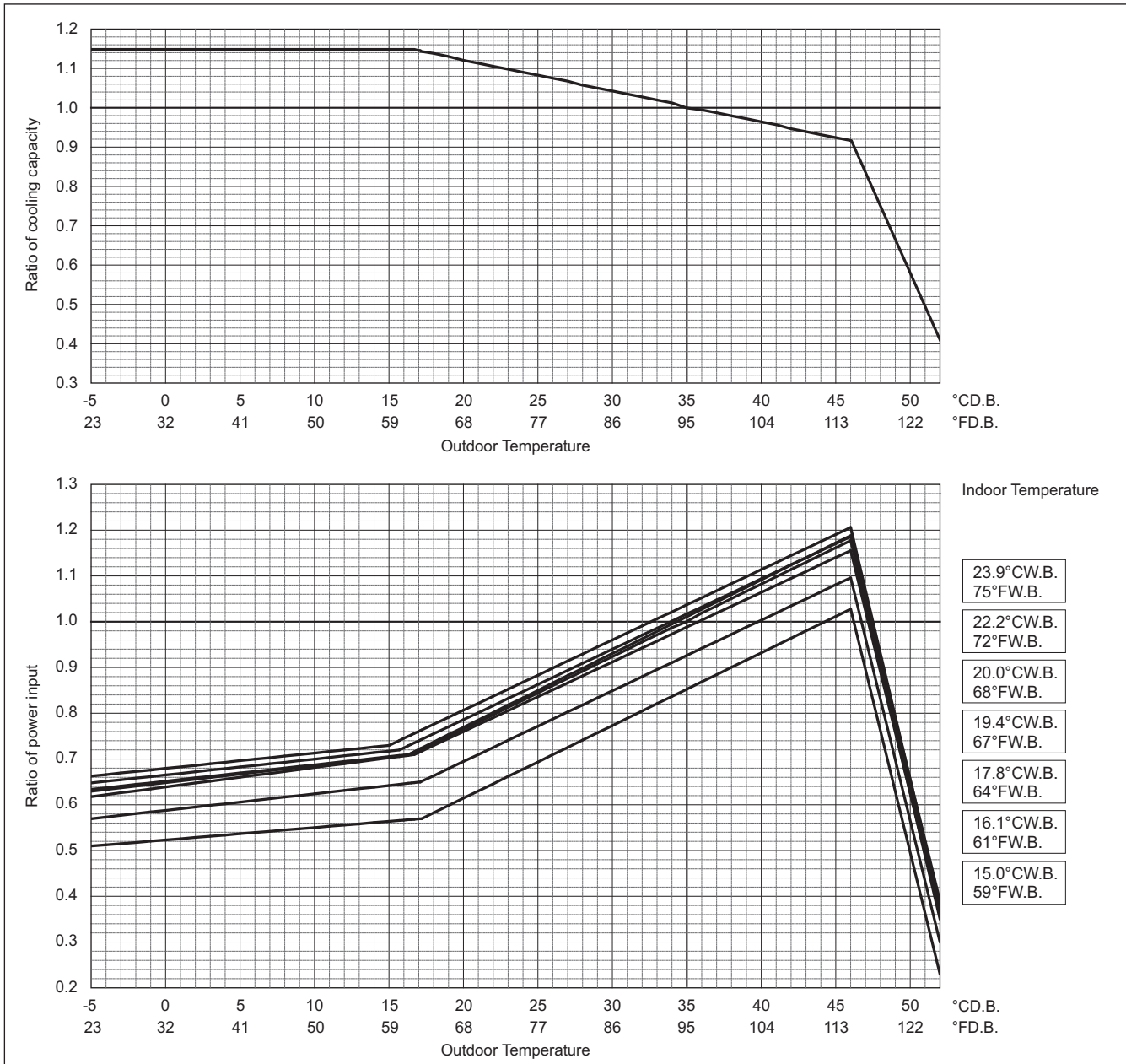

COP Priority Mode

PURY-		EP264TSNU/YSNU	
		Non-Ducted	Ducted
Nominal Heating capacity	BTU/h	295,000	
	kW	86.5	
	Input kW	24.56	

Indoor unit temperature correction

To be used to correct indoor unit capacity only

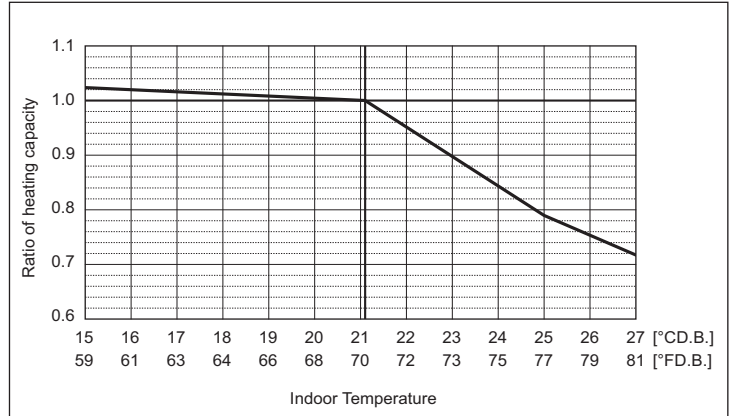

Outdoor unit temperature correction

To be used to correct outdoor unit only

Outdoor unit capacity is NOT affected by the indoor temperature.

Outdoor unit power input is affected by the indoor and outdoor temperatures. Please consult the sales office for details.

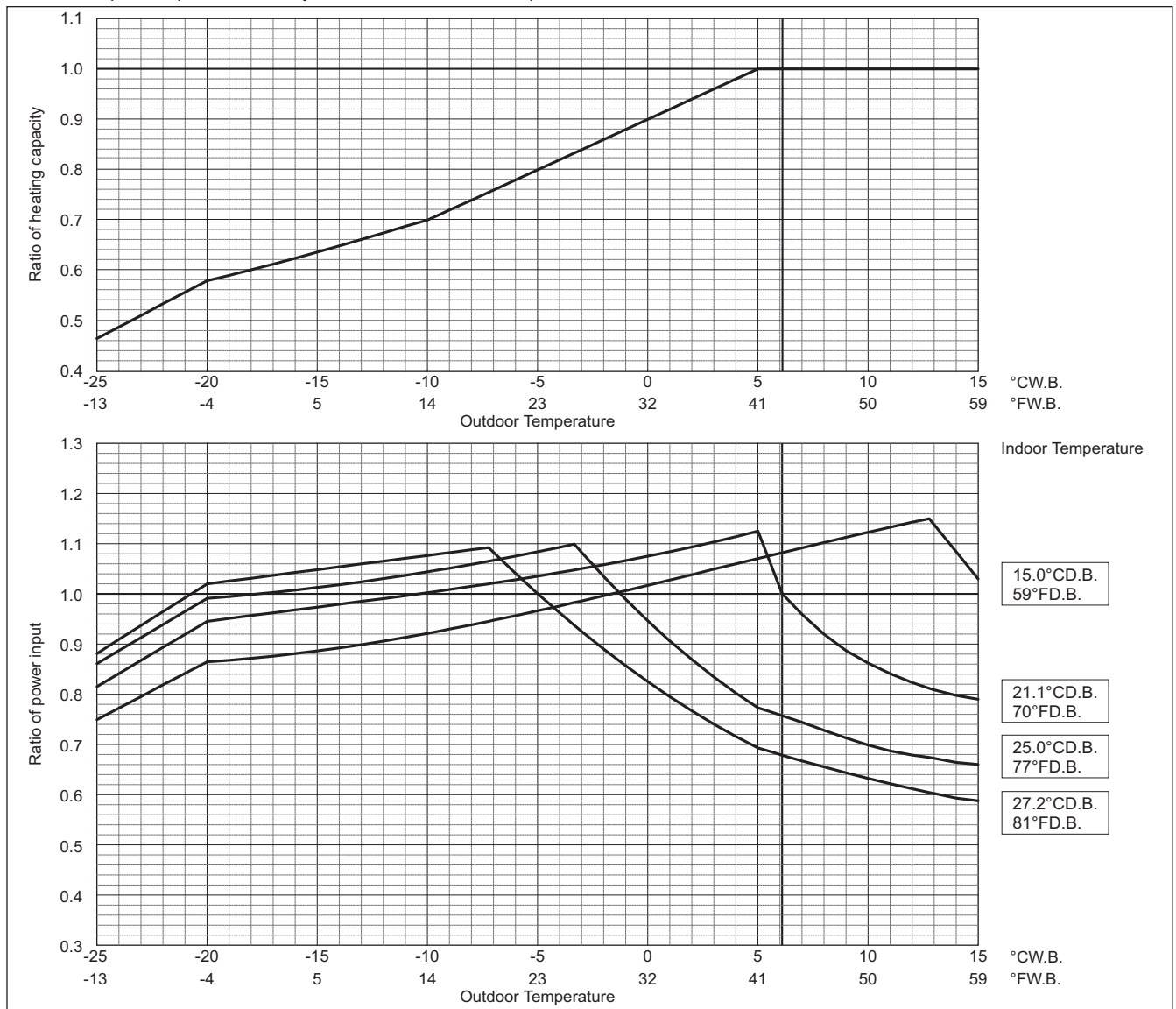

PURY-EP-T(S)NU-A, Y(S)NU-A

PURY-		EP288TSNU/YSNU	
		Non-Ducted	Ducted
Nominal cooling capacity	BTU/h	288,000	
	kW	84.4	
	Input kW	24.83	

Indoor unit temperature correction
To be used to correct indoor unit capacity only

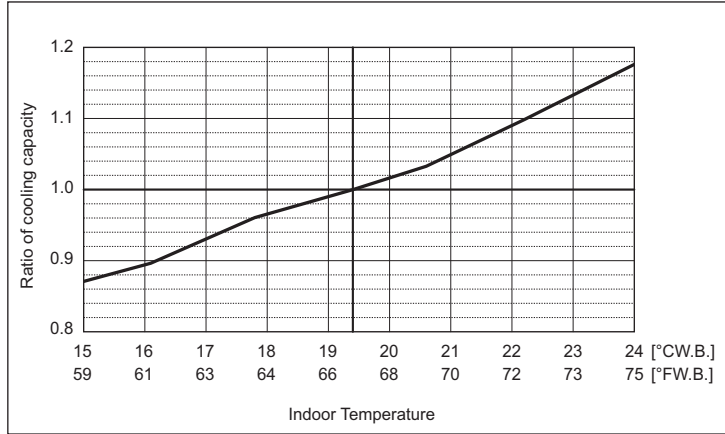

Outdoor unit temperature correction

To be used to correct outdoor unit only

Outdoor unit capacity is NOT affected by the indoor temperature.

Outdoor unit power input is affected by the indoor and outdoor temperatures. Please consult the sales office for details.

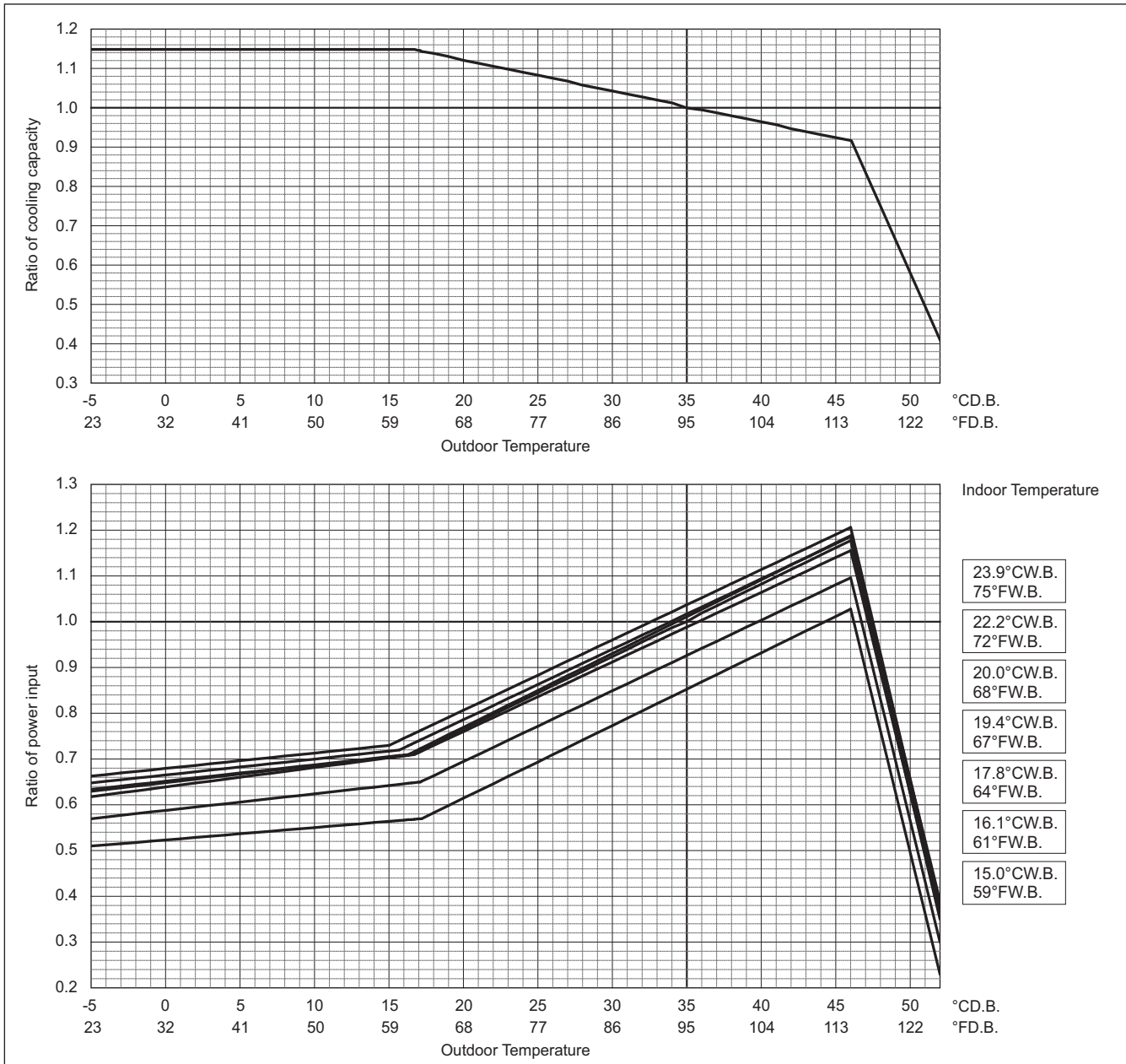

COP Priority Mode

PURY-		EP288TSNU/YSNU	
		Non-Ducted	Ducted
Nominal Heating capacity	BTU/h	323,000	
	kW	94.7	
	Input kW	27.30	

Indoor unit temperature correction

To be used to correct indoor unit capacity only

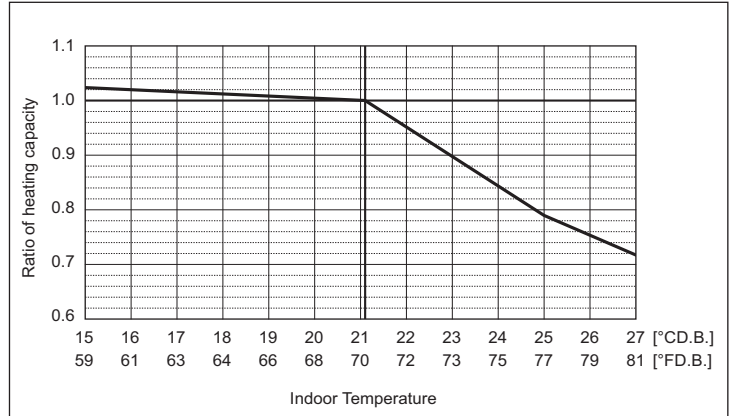

Outdoor unit temperature correction

To be used to correct outdoor unit only

Outdoor unit capacity is NOT affected by the indoor temperature.

Outdoor unit power input is affected by the indoor and outdoor temperatures. Please consult the sales office for details.

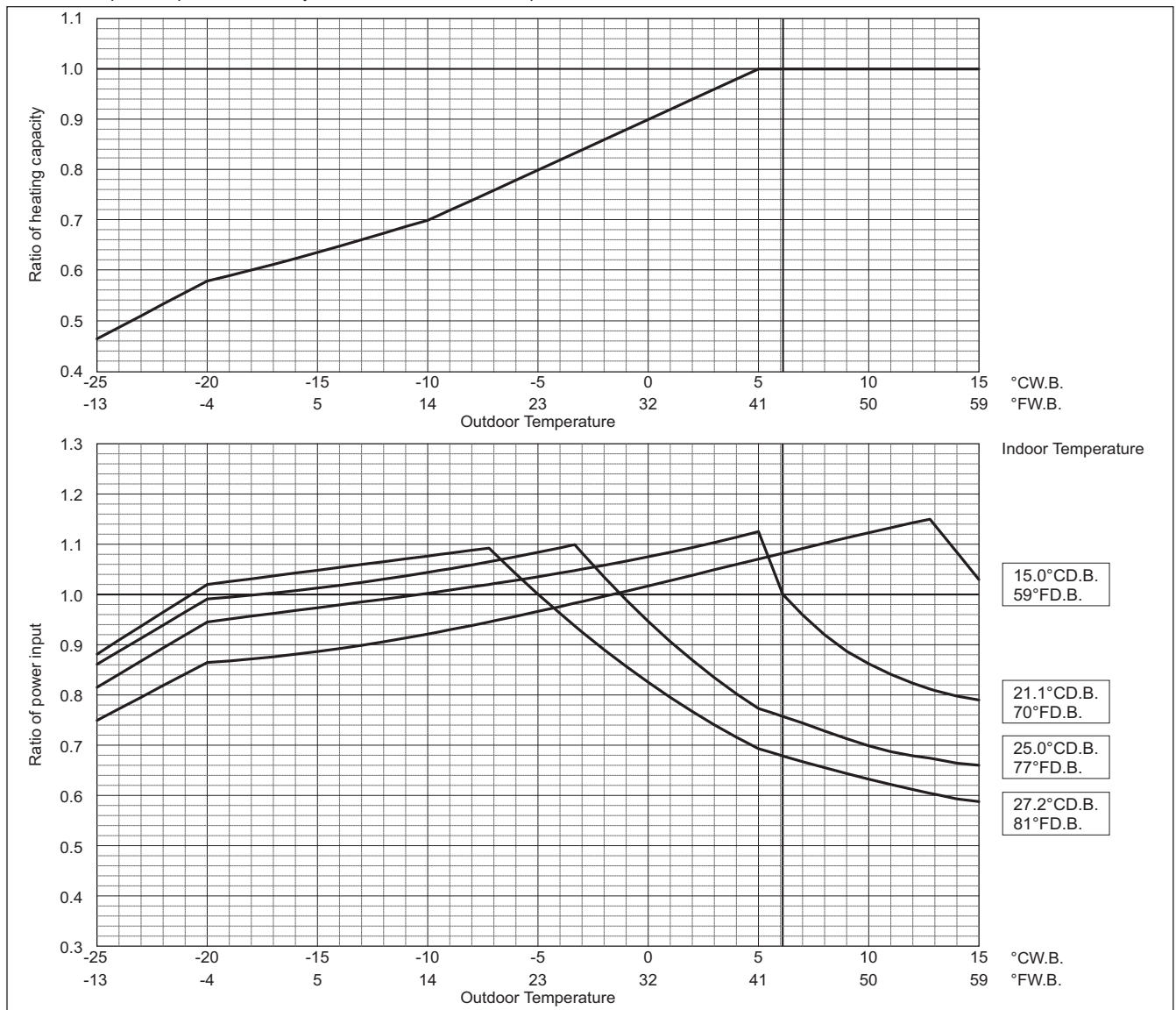

PURY-EP-T(S)NU-A, Y(S)NU-A

PURY-	EP312TSNU/YSNU		EP336TSNU/YSNU	
	Non-Ducted	Ducted	Non-Ducted	Ducted
Nominal cooling capacity	312,000		336,000	
	91.4		98.5	
Input	27.98		31.43	

Indoor unit temperature correction
To be used to correct indoor unit capacity only

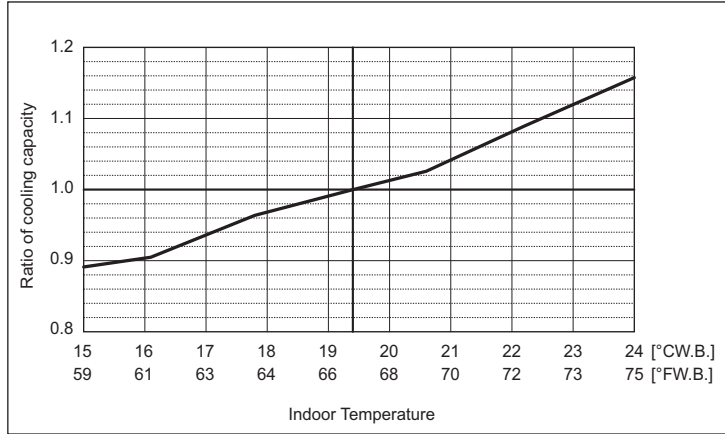

Outdoor unit temperature correction

To be used to correct outdoor unit only

Outdoor unit capacity is NOT affected by the indoor temperature.

Outdoor unit power input is affected by the indoor and outdoor temperatures. Please consult the sales office for details.

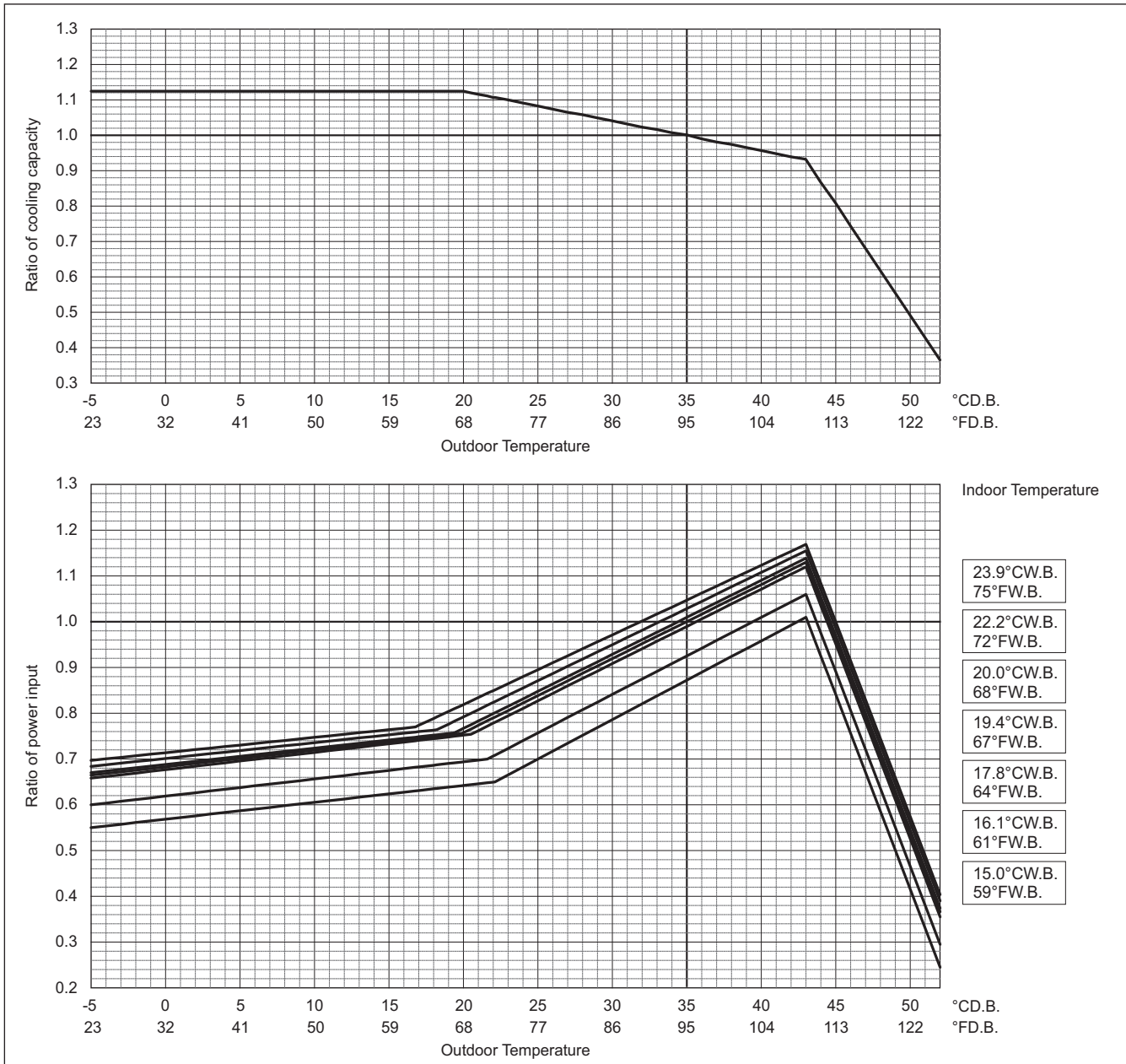

COP Priority Mode

PURY-		EP312TSNU/YSNU		EP336TSNU/YSNU	
		Non-Ducted	Ducted	Non-Ducted	Ducted
Nominal Heating capacity	BTU/h	350,000		378,000	
	kW	102.6		110.8	
	Input kW	30.53		33.55	

Indoor unit temperature correction

To be used to correct indoor unit capacity only

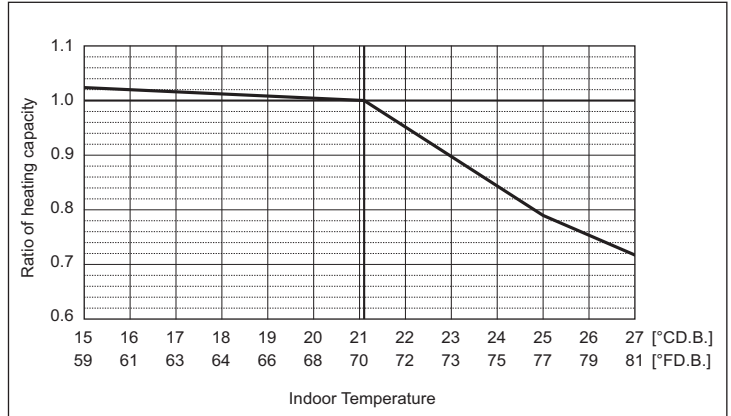

Outdoor unit temperature correction

To be used to correct outdoor unit only

Outdoor unit capacity is NOT affected by the indoor temperature.

Outdoor unit power input is affected by the indoor and outdoor temperatures. Please consult the sales office for details.

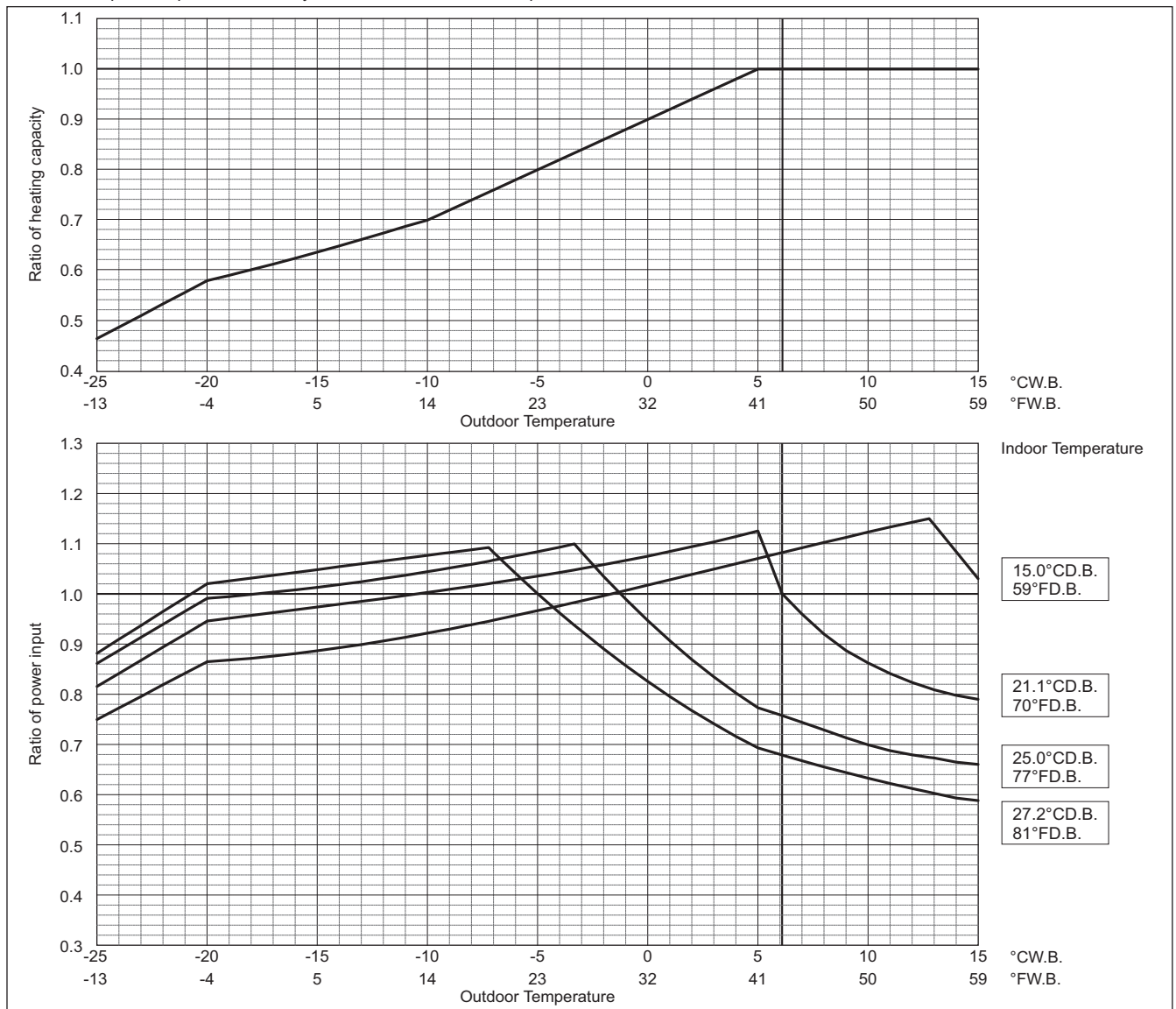

PURY-EP-T(S)NU-A, Y(S)NU-A

PURY-	EP384TSNU/YSNU		EP432TSNU/YSNU	
	Non-Ducted	Ducted	Non-Ducted	Ducted
Nominal cooling capacity	BTU/h	384,000	432,000	
	kW	112.5	126.6	
	Input kW	36.62	42.36	

Indoor unit temperature correction
To be used to correct indoor unit capacity only

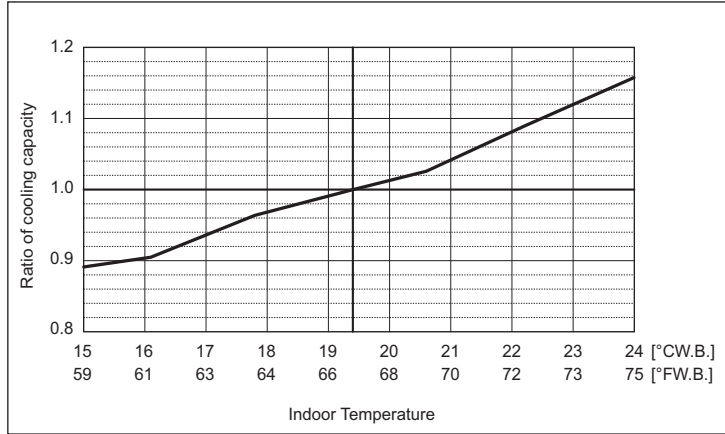

Outdoor unit temperature correction

To be used to correct outdoor unit only

Outdoor unit capacity is NOT affected by the indoor temperature.

Outdoor unit power input is affected by the indoor and outdoor temperatures. Please consult the sales office for details.

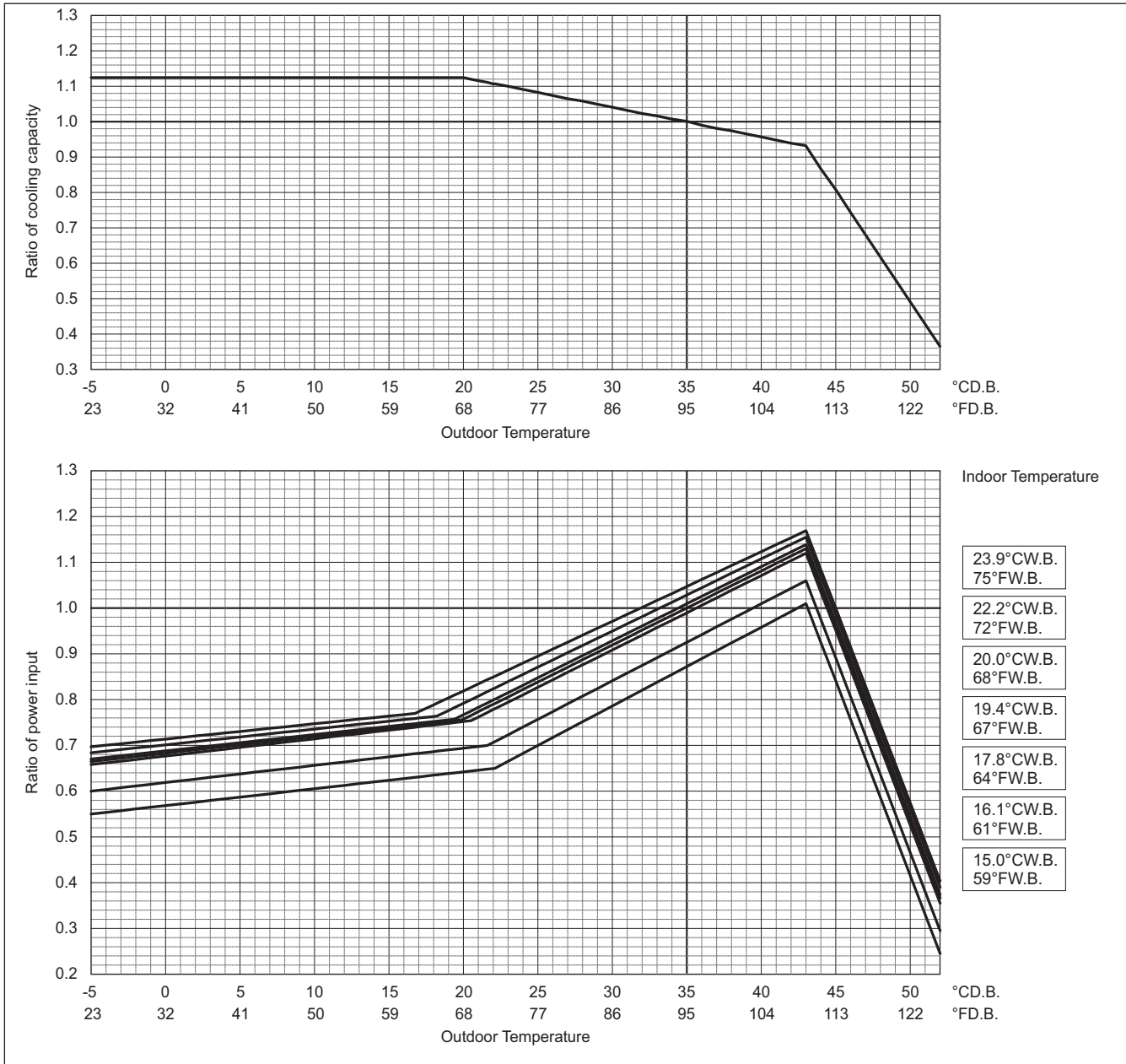

COP Priority Mode

PURY-		EP384TSNU/YSNU		EP432TSNU/YSNU	
		Non-Ducted	Ducted	Non-Ducted	Ducted
Nominal Heating capacity	BTU/h	430,000		480,000	
	kW	126.0		140.7	
	Input kW	38.66		43.14	

Indoor unit temperature correction

To be used to correct indoor unit capacity only

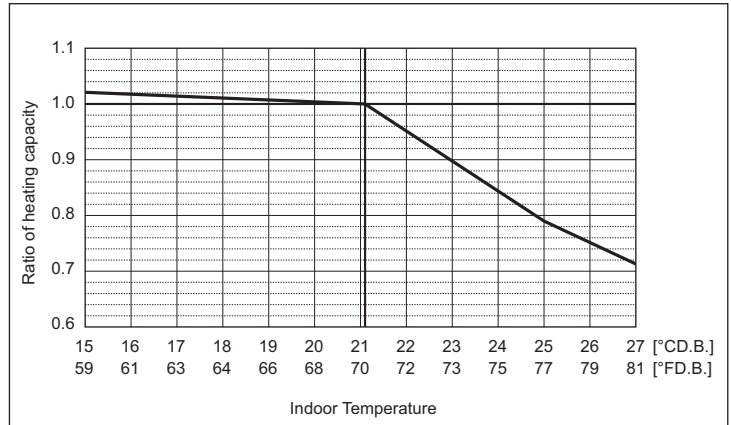

Outdoor unit temperature correction

To be used to correct outdoor unit only

Outdoor unit capacity is NOT affected by the indoor temperature.

Outdoor unit power input is affected by the indoor and outdoor temperatures. Please consult the sales office for details.

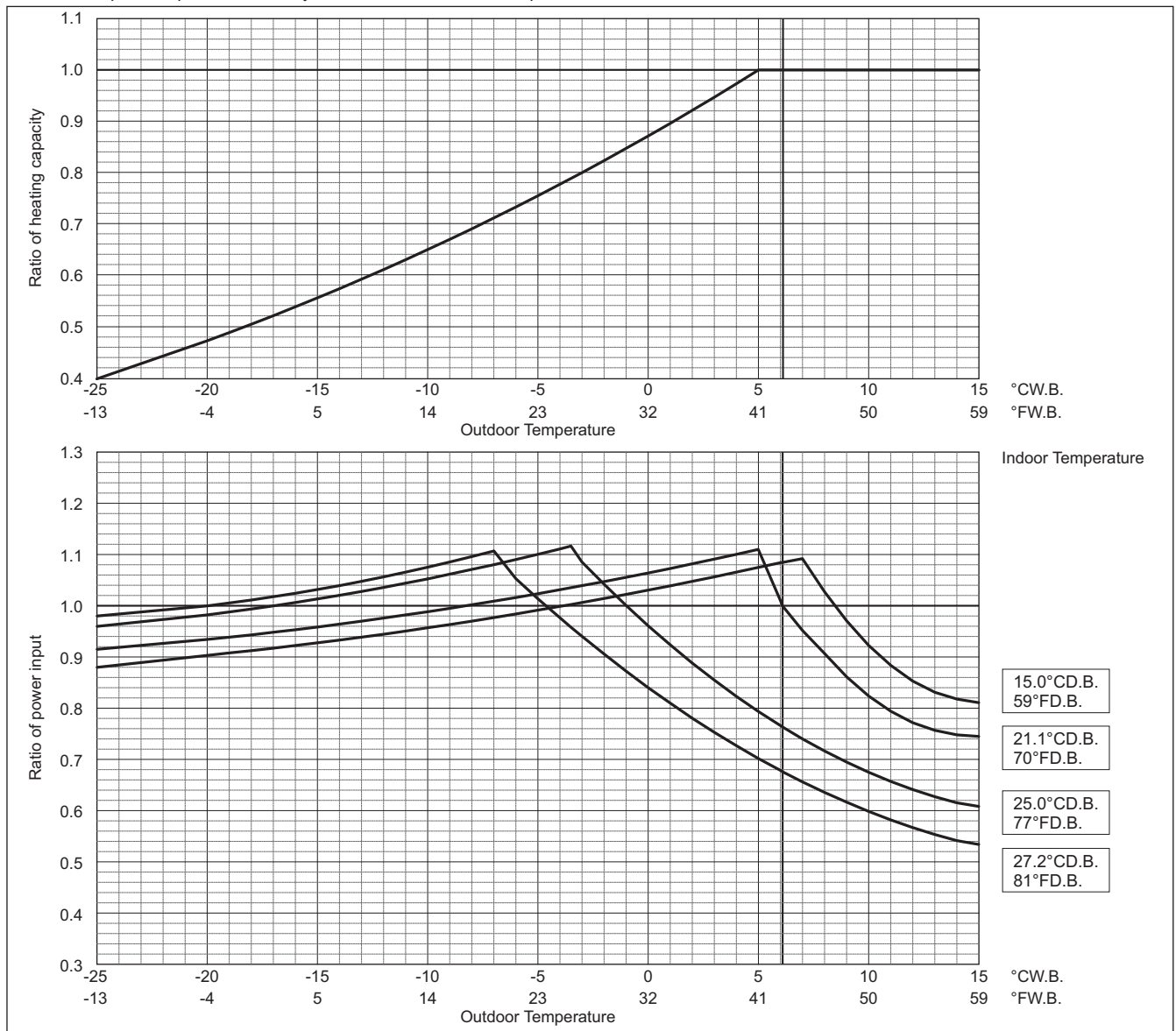

8-3. Correction by total indoor

CITY MULTI system has different capacities and inputs when many combinations of indoor units with different total capacities are connected. Using following tables, the maximum capacity can be found to ensure the system is installed with enough capacity for a particular application.

PURY-EP-T(S)NU-A, Y(S)NU-A

PURY-		EP72TNU/YNU	
		Non-Ducted	Ducted
Nominal cooling capacity	BTU/h	72,000	
	kW	21.1	
	Input kW	4.44	

PURY-		EP72TNU/YNU	
		Non-Ducted	Ducted
Nominal Heating capacity	BTU/h	80,000	
	kW	23.4	
	Input kW	5.43	

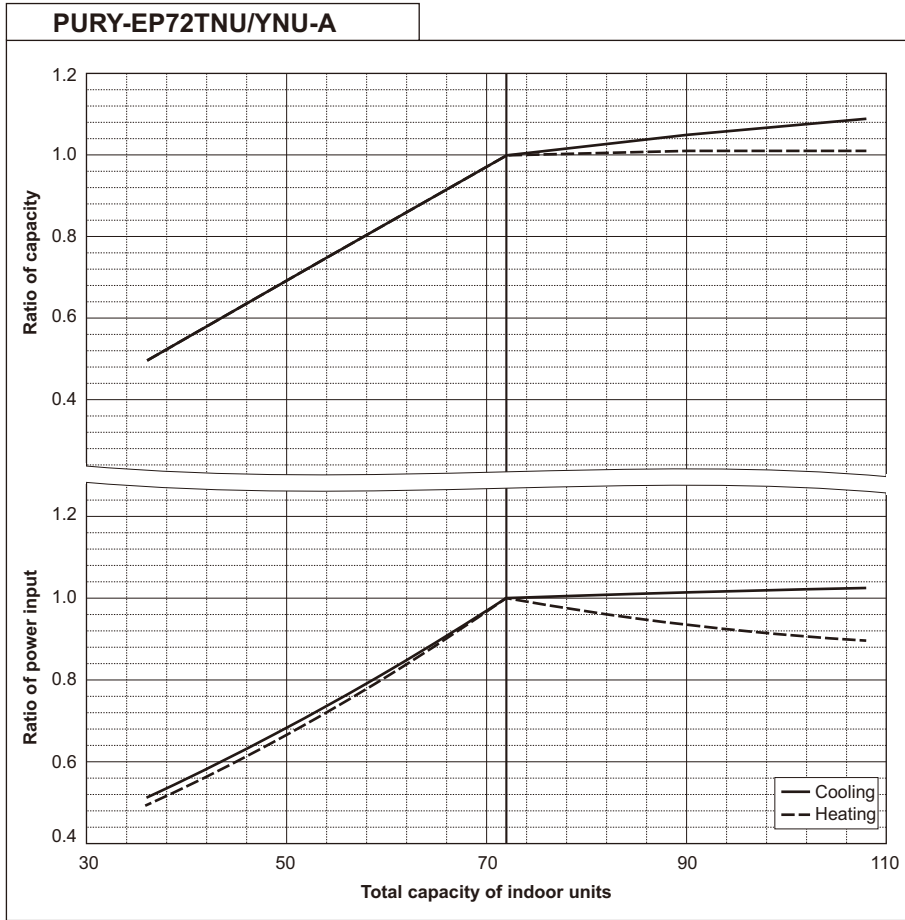

PURY-		EP96TNU/YNU	
		Non-Ducted	Ducted
Nominal cooling capacity	BTU/h	96,000	
	kW	28.1	
	Input kW	6.11	

PURY-		EP96TNU/YNU	
		Non-Ducted	Ducted
Nominal Heating capacity	BTU/h	108,000	
	kW	31.7	
	Input kW	7.40	

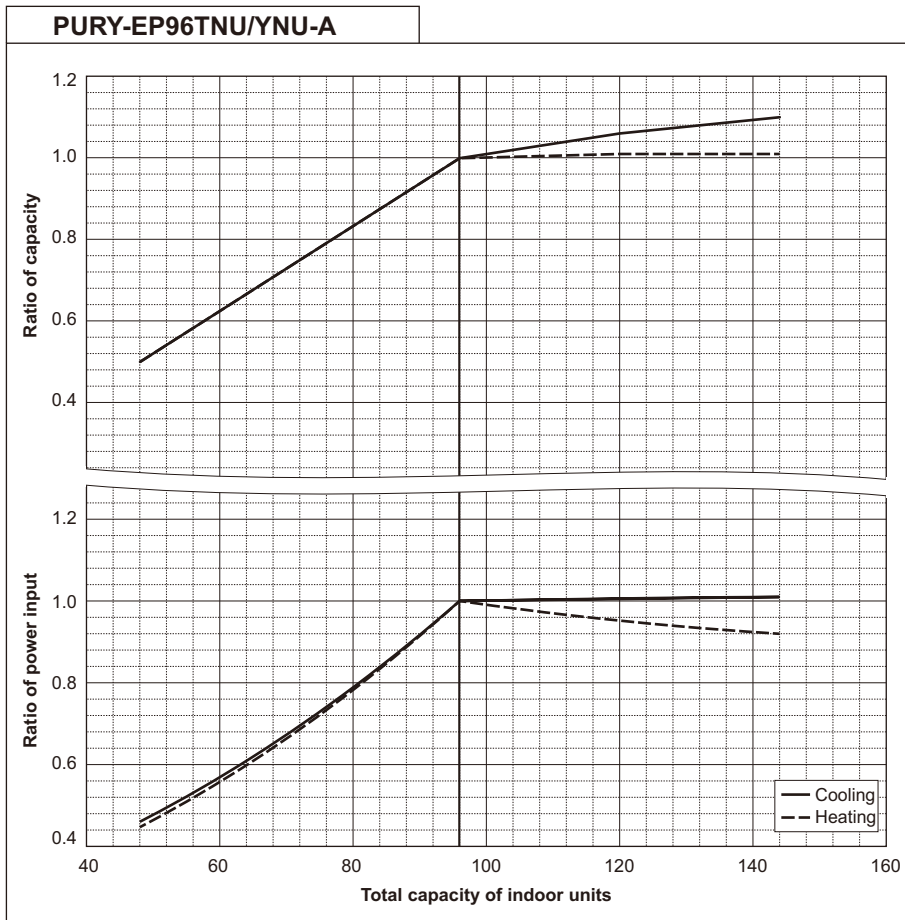

PURY-		EP120TNU/YNU	
		Non-Ducted	Ducted
Nominal cooling capacity	BTU/h	120,000	
	kW	35.2	
	Input kW	8.43	

PURY-		EP120TNU/YNU	
		Non-Ducted	Ducted
Nominal Heating capacity	BTU/h	135,000	
	kW	39.6	
	Input kW	9.89	

PURY-EP120TNU/YNU-A

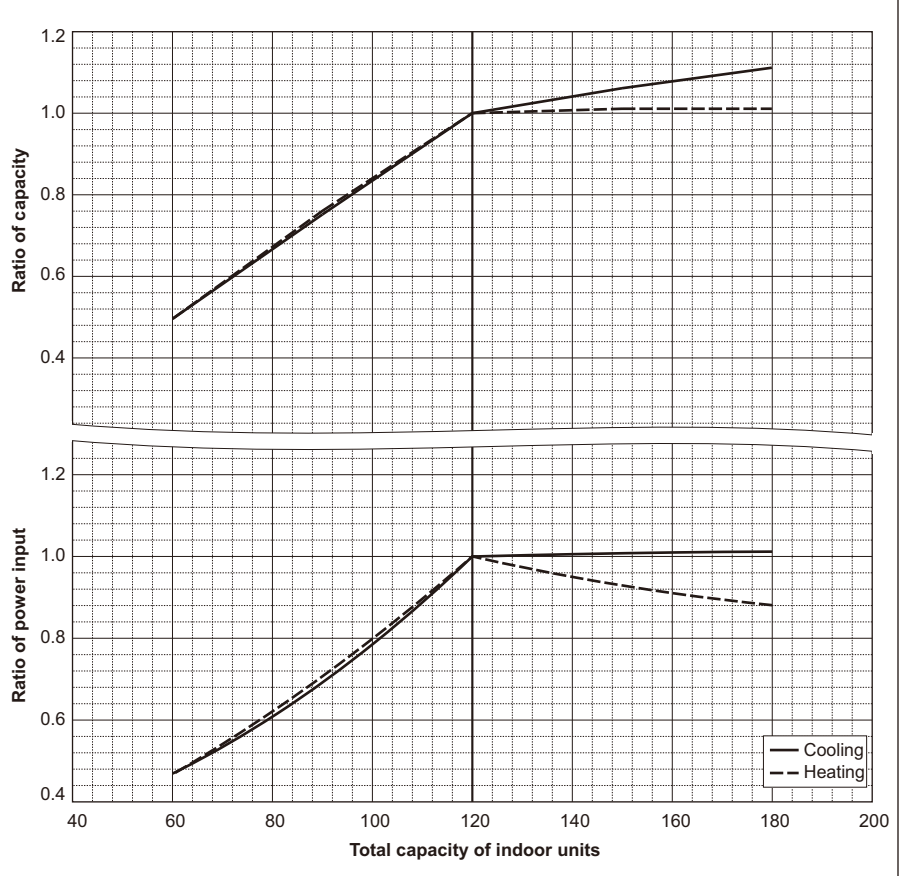

PURY-		EP144TNU/YNU	
		Non-Ducted	Ducted
Nominal cooling capacity	BTU/h	144,000	
	kW	42.2	
	Input kW	11.03	

PURY-		EP144TNU/YNU	
		Non-Ducted	Ducted
Nominal Heating capacity	BTU/h	160,000	
	kW	46.9	
	Input kW	12.34	

PURY-EP144TNU/YNU-A

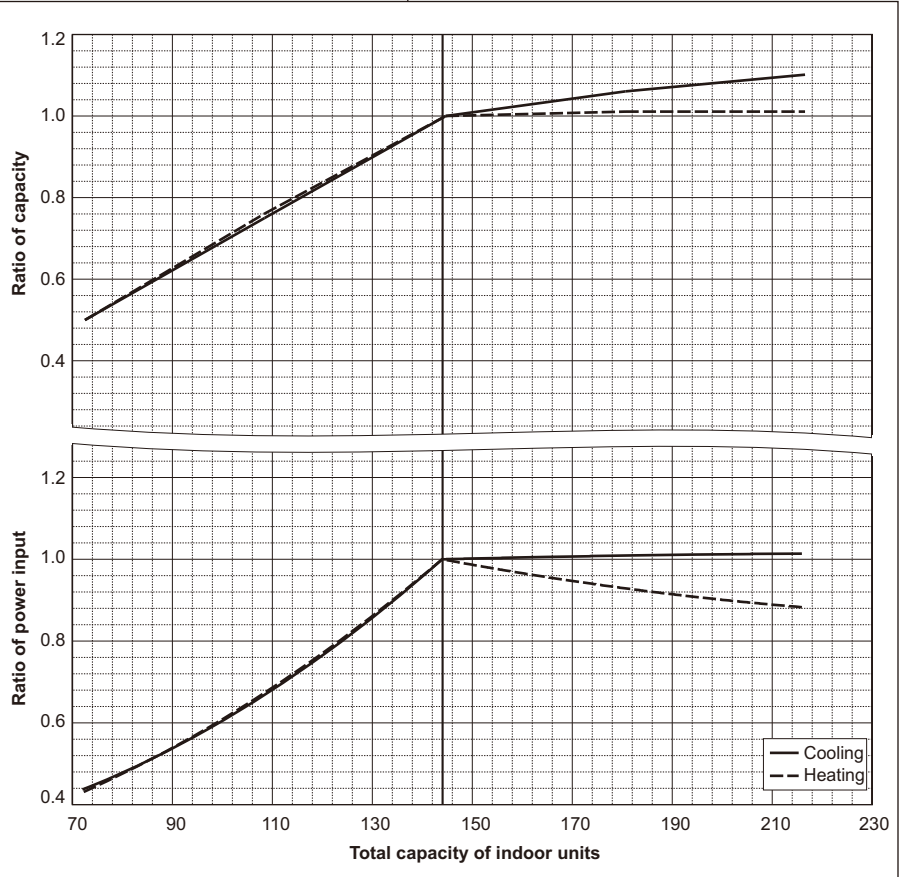

PURY-EP-T(S)NU-A, Y(S)NU-A

PURY-EP-T(S)NU-A, Y(S)NU-A

PURY-		EP168TNU/YNU	
		Non-Ducted	Ducted
Nominal cooling capacity	BTU/h	168,000	
	kW	49.2	
	Input kW	13.99	

PURY-		EP168TNU/YNU	
		Non-Ducted	Ducted
Nominal Heating capacity	BTU/h	188,000	
	kW	55.1	
	Input kW	15.17	

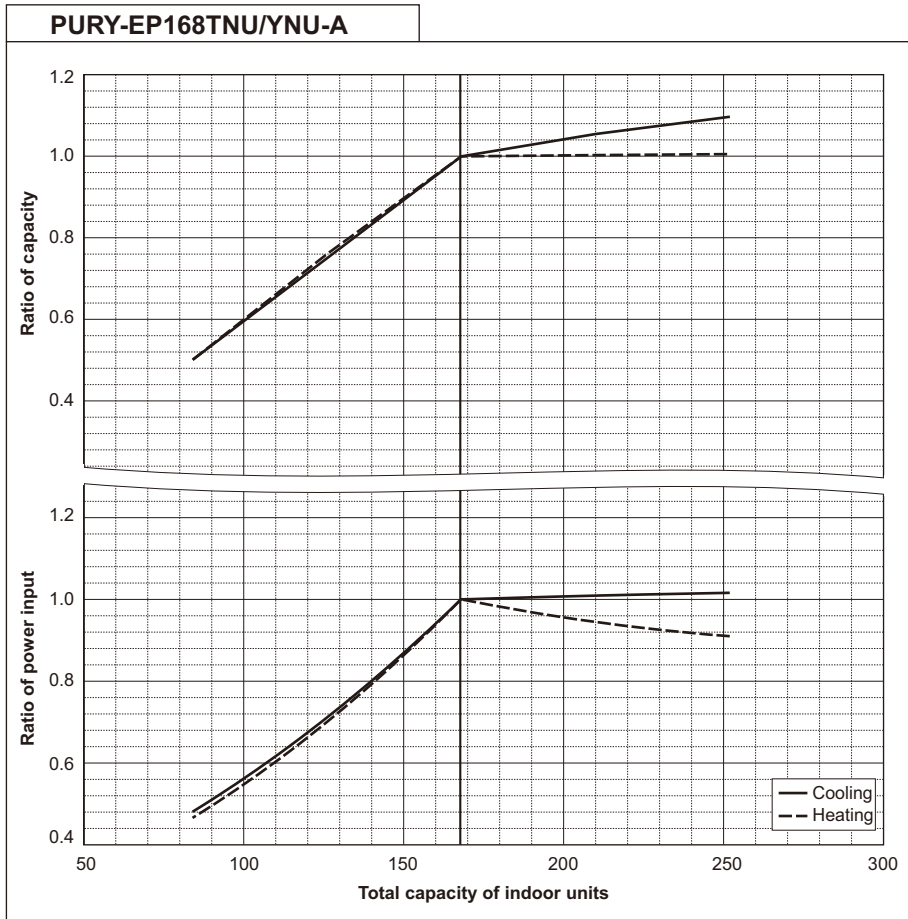

PURY-		EP192TNU/YNU	
		Non-Ducted	Ducted
Nominal cooling capacity	BTU/h	192,000	
	kW	56.3	
	Input kW	15.65	

PURY-		EP192TNU/YNU	
		Non-Ducted	Ducted
Nominal Heating capacity	BTU/h	215,000	
	kW	63.0	
	Input kW	17.54	

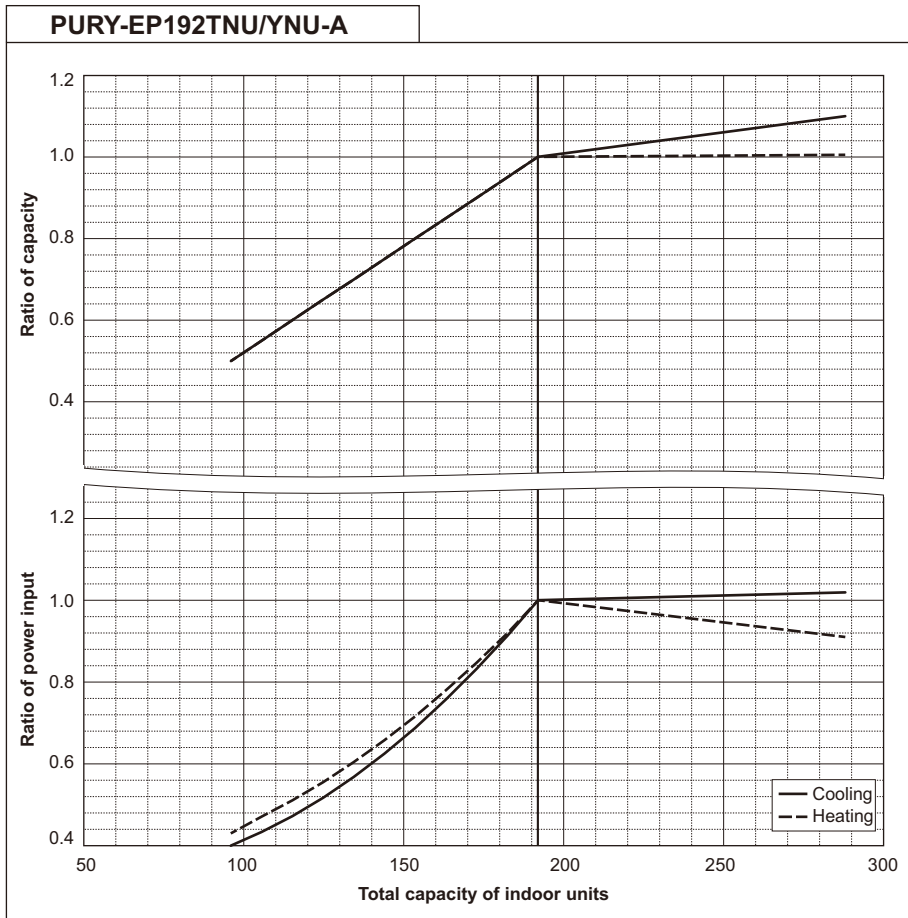

PURY-		EP216TNU/YNU	
		Non-Ducted	Ducted
Nominal cooling capacity	BTU/h	216,000	
	kW	63.3	
	Input kW	18.66	

PURY-		EP216TNU/YNU	
		Non-Ducted	Ducted
Nominal Heating capacity	BTU/h	243,000	
	kW	71.2	
	Input kW	20.43	

PURY-EP216TNU/YNU-A

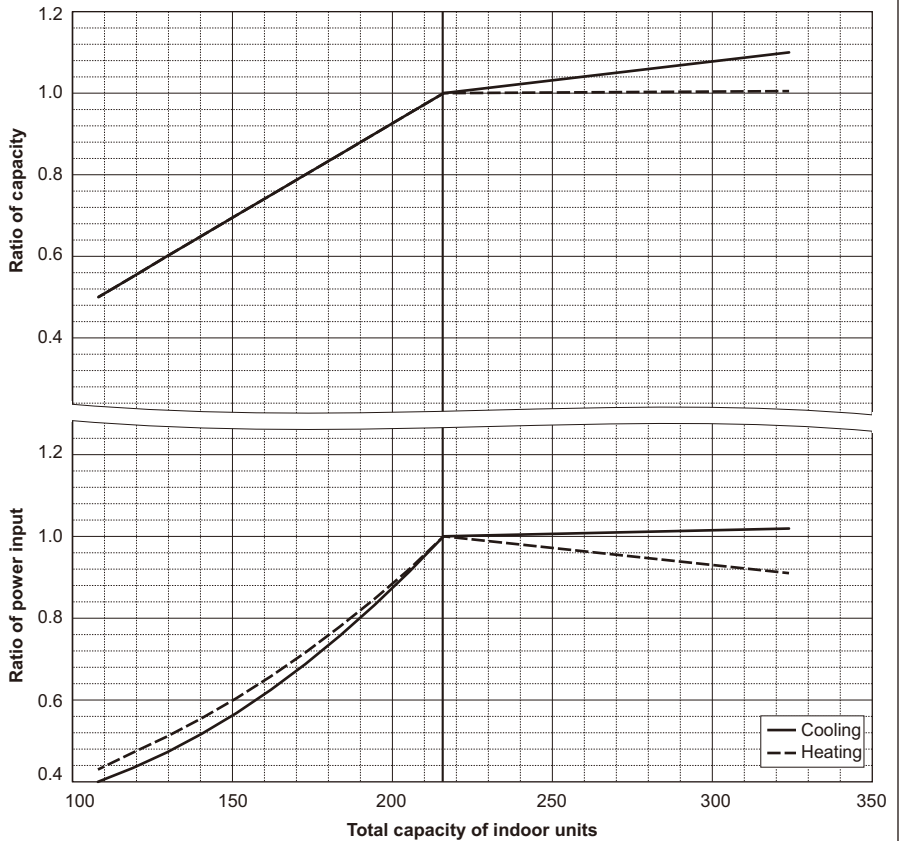

PURY-		EP240TNU/YNU	
		Non-Ducted	Ducted
Nominal cooling capacity	BTU/h	224,000	
	kW	65.7	
	Input kW	21.39	

PURY-		EP240TNU/YNU	
		Non-Ducted	Ducted
Nominal Heating capacity	BTU/h	250,000	
	kW	73.3	
	Input kW	21.79	

PURY-EP240TNU/YNU-A

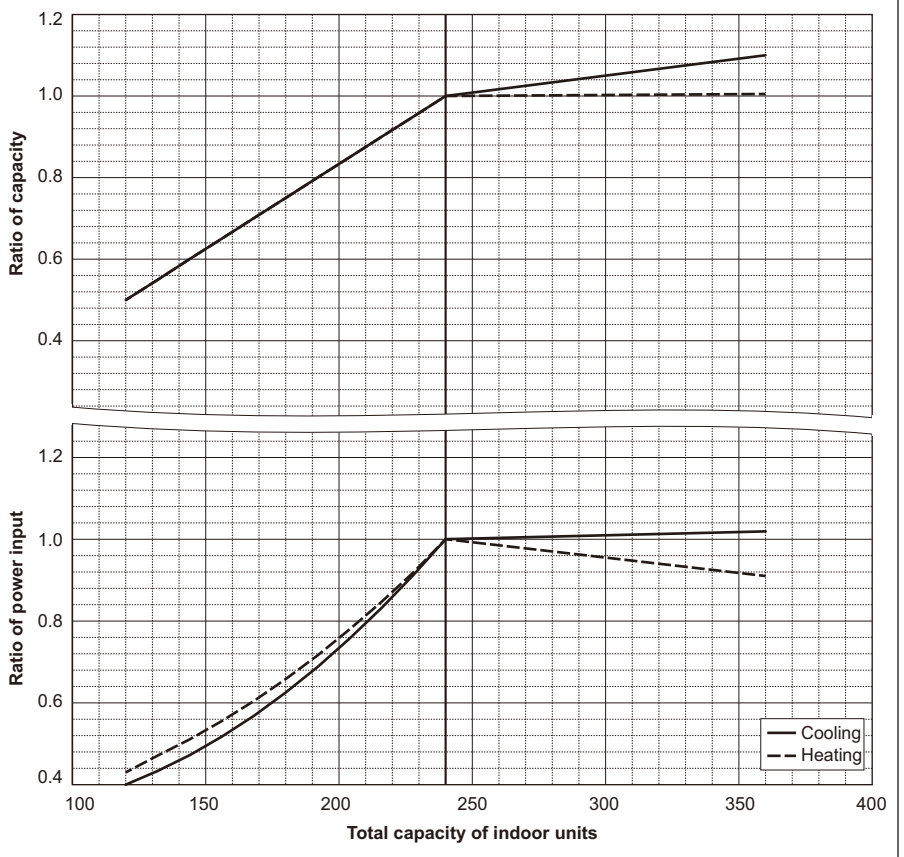

PURY-EP-T(S)NU-A, Y(S)NU-A

PURY-EP-T(S)NU-A, Y(S)NU-A

PURY-		EP192TSNU/YSNU	
		Non-Ducted	Ducted
Nominal cooling capacity	BTU/h	192,000	
	kW	56.3	
	Input kW	13.60	

PURY-		EP192TSNU/YSNU	
		Non-Ducted	Ducted
Nominal Heating capacity	BTU/h	215,000	
	kW	63.0	
	Input kW	16.02	

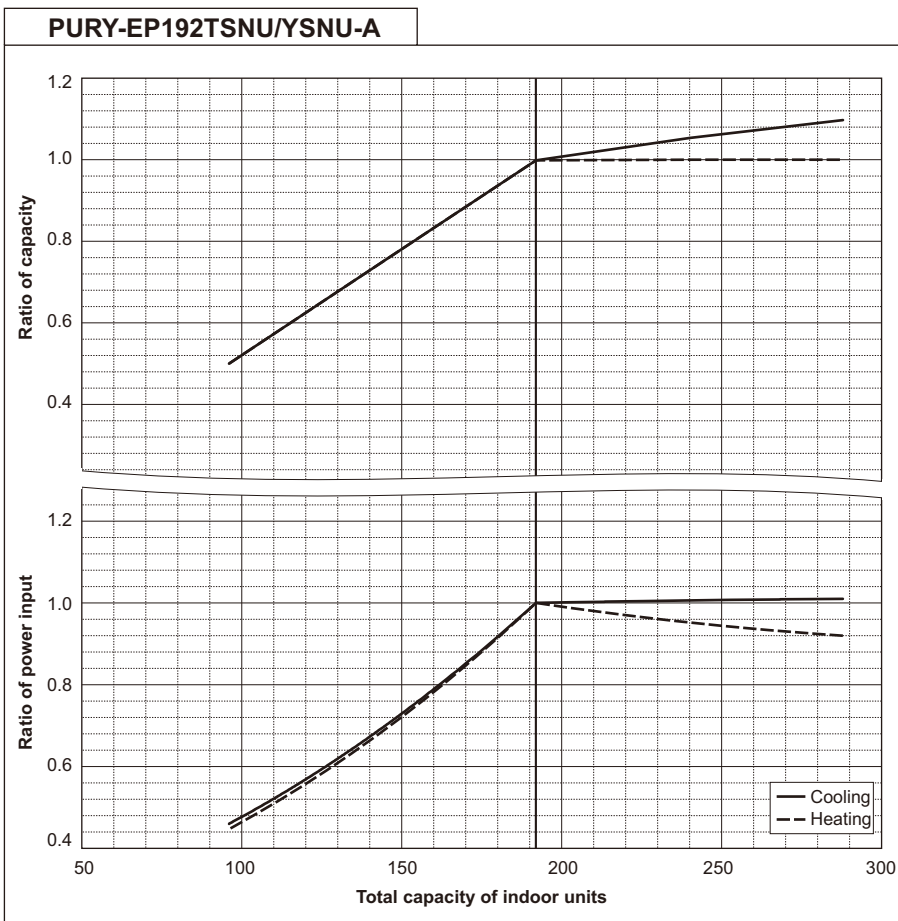

PURY-		EP216TSNU/YSNU	
		Non-Ducted	Ducted
Nominal cooling capacity	BTU/h	216,000	
	kW	63.3	
	Input kW	16.06	

PURY-		EP216TSNU/YSNU	
		Non-Ducted	Ducted
Nominal Heating capacity	BTU/h	243,000	
	kW	71.2	
	Input kW	18.67	

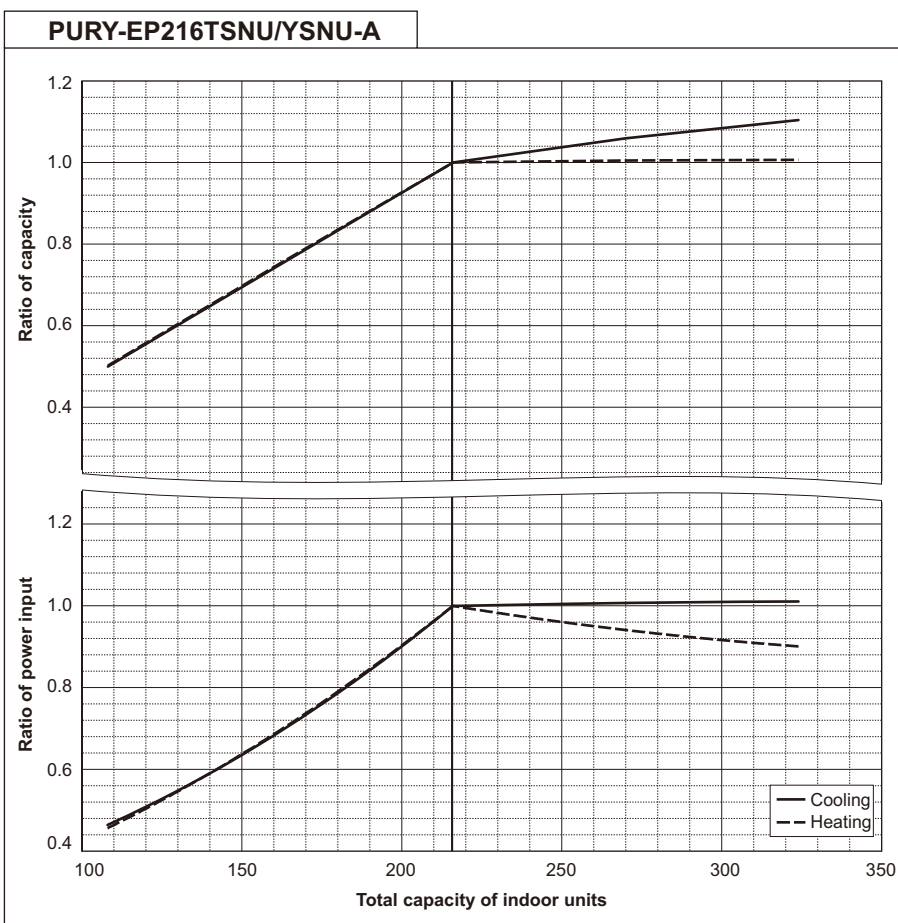

PURY-		EP240TSNU/YSNU	
		Non-Ducted	Ducted
Nominal cooling capacity	BTU/h	240,000	
	kW	70.3	
	Input kW	19.17	

PURY-		EP240TSNU/YSNU	
		Non-Ducted	Ducted
Nominal Heating capacity	BTU/h	270,000	
	kW	79.1	
	Input kW	22.03	

PURY-EP240TSNU/YSNU-A

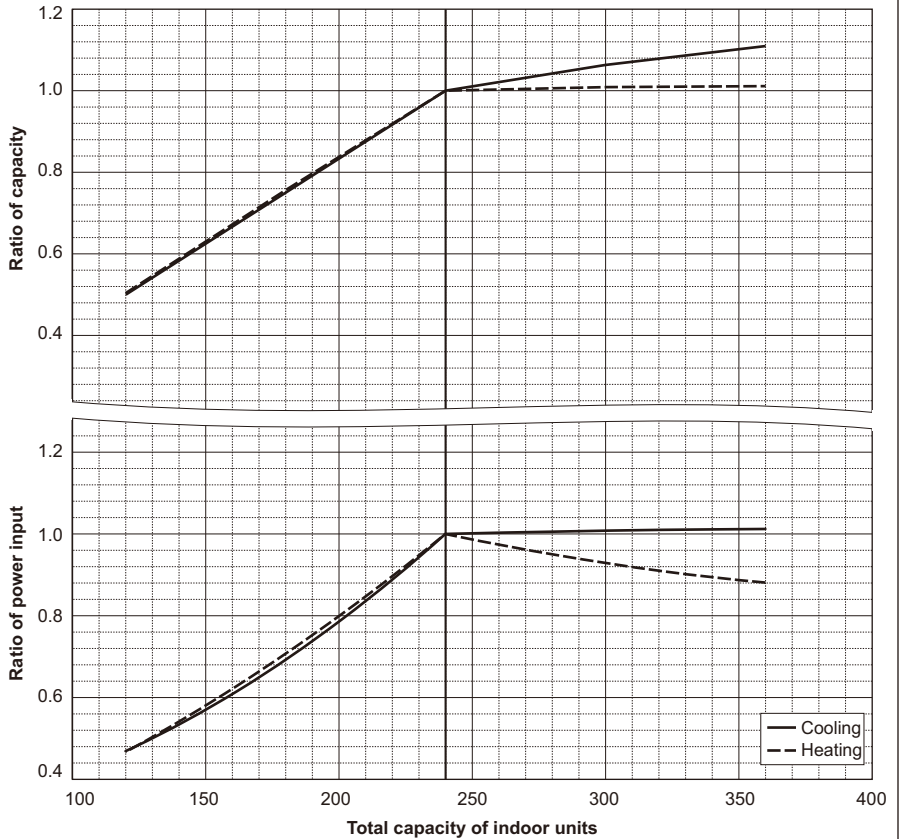

PURY-		EP264TSNU/YSNU	
		Non-Ducted	Ducted
Nominal cooling capacity	BTU/h	264,000	
	kW	77.4	
	Input kW	21.86	

PURY-		EP264TSNU/YSNU	
		Non-Ducted	Ducted
Nominal Heating capacity	BTU/h	295,000	
	kW	86.5	
	Input kW	24.56	

PURY-EP264TSNU/YSNU-A

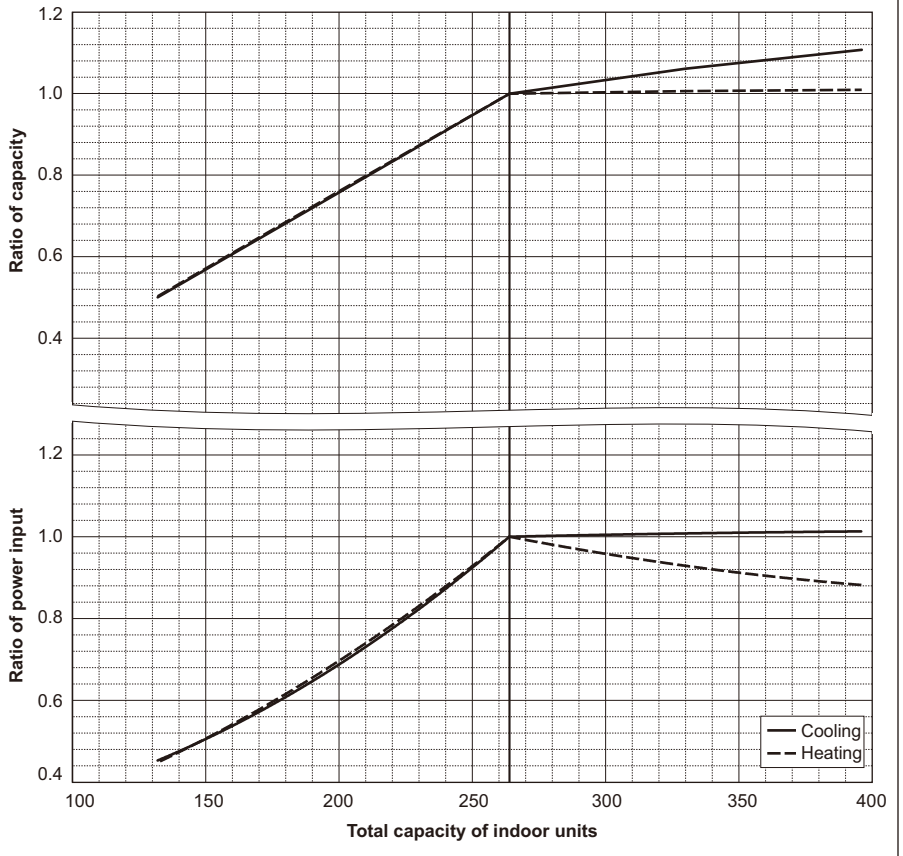

PURY-EP-T(S)NU-A, Y(S)NU-A

PURY-EP-T(S)NU-A, Y(S)NU-A

PURY-		EP288TSNU/YSNU	
		Non-Ducted	Ducted
Nominal cooling capacity	BTU/h	288,000	
	kW	84.4	
	Input kW	24.83	

PURY-		EP288TSNU/YSNU	
		Non-Ducted	Ducted
Nominal Heating capacity	BTU/h	323,000	
	kW	94.7	
	Input kW	27.30	

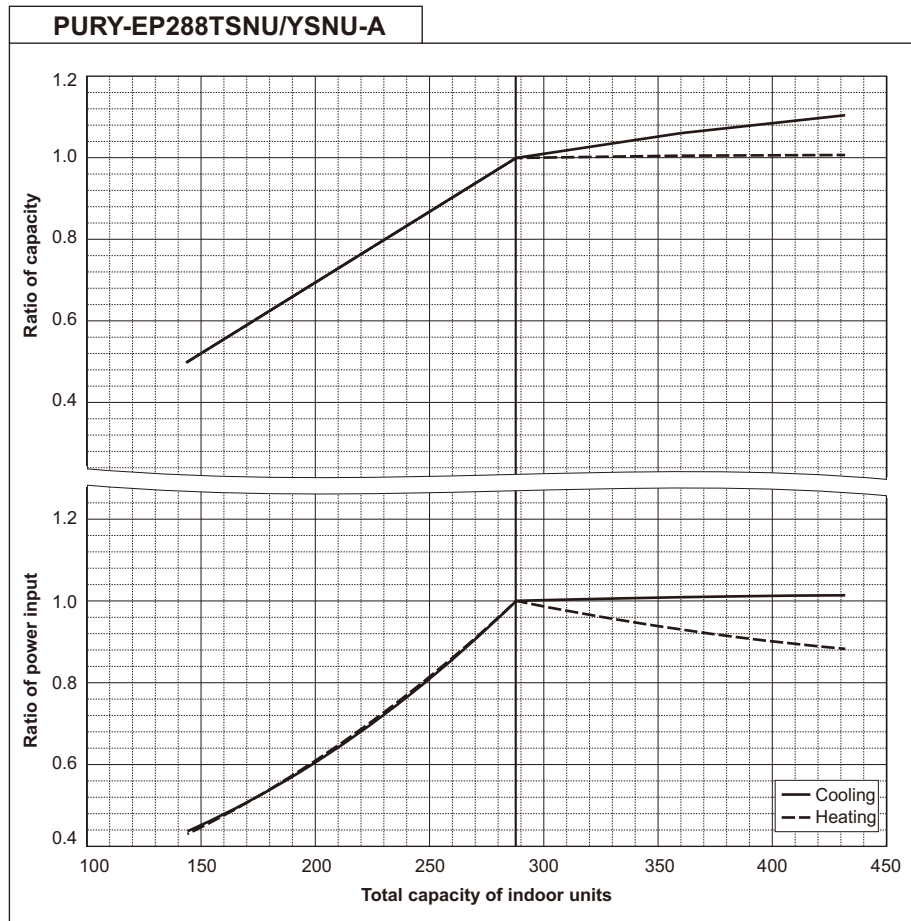

PURY-		EP312TSNU/YSNU	
		Non-Ducted	Ducted
Nominal cooling capacity	BTU/h	312,000	
	kW	91.4	
	Input kW	27.98	

PURY-		EP312TSNU/YSNU	
		Non-Ducted	Ducted
Nominal Heating capacity	BTU/h	350,000	
	kW	102.6	
	Input kW	30.53	

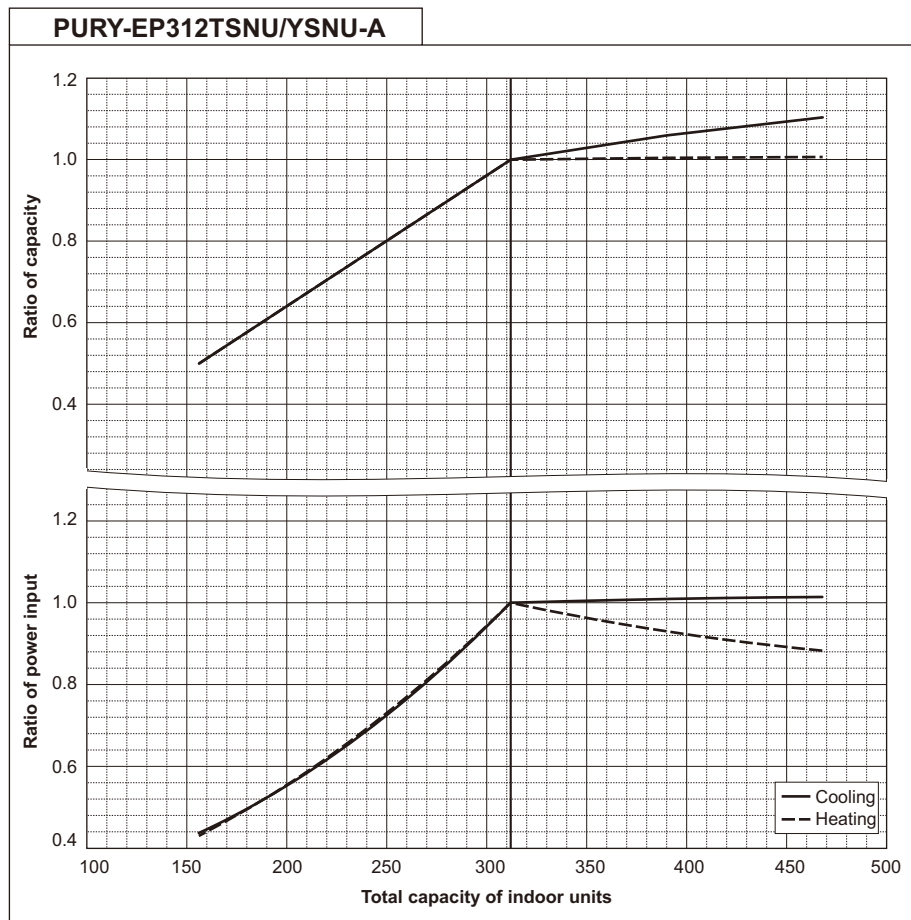

PURY-		EP336TSNU/YSNU	
		Non-Ducted	Ducted
Nominal cooling capacity	BTU/h	336,000	
	kW	98.5	
	Input kW	31.43	

PURY-		EP336TSNU/YSNU	
		Non-Ducted	Ducted
Nominal Heating capacity	BTU/h	378,000	
	kW	110.8	
	Input kW	33.55	

PURY-EP336TSNU/YSNU-A

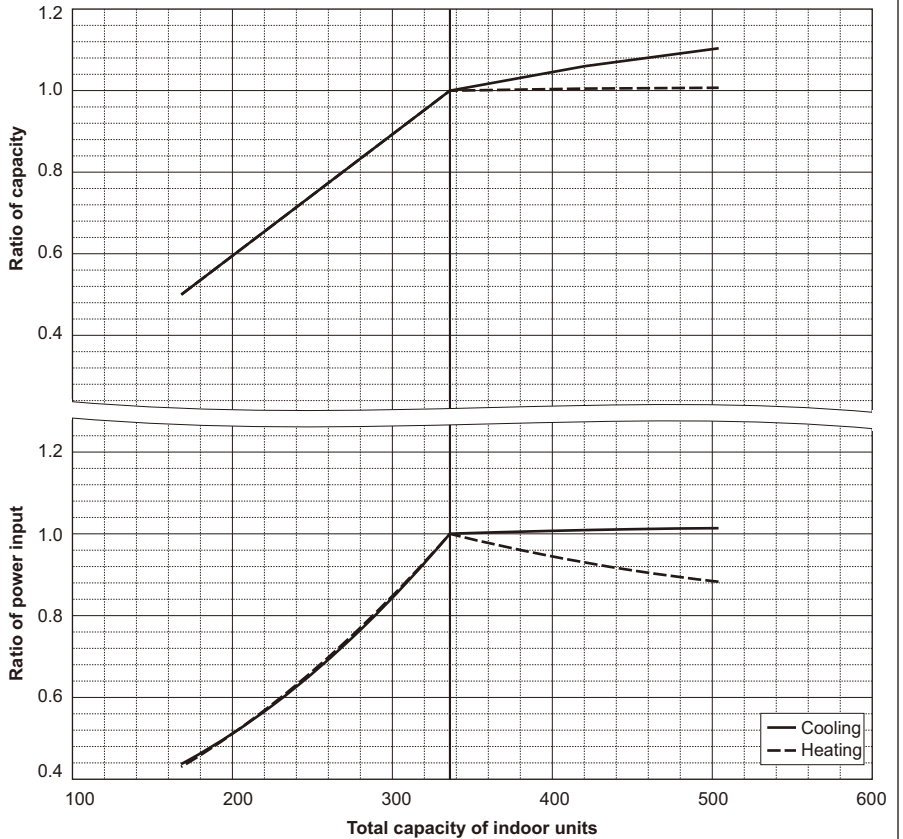

PURY-		EP384TSNU/YSNU	
		Non-Ducted	Ducted
Nominal cooling capacity	BTU/h	384,000	
	kW	112.5	
	Input kW	36.62	

PURY-		EP384TSNU/YSNU	
		Non-Ducted	Ducted
Nominal Heating capacity	BTU/h	430,000	
	kW	126.0	
	Input kW	38.66	

PURY-EP384TSNU/YSNU-A

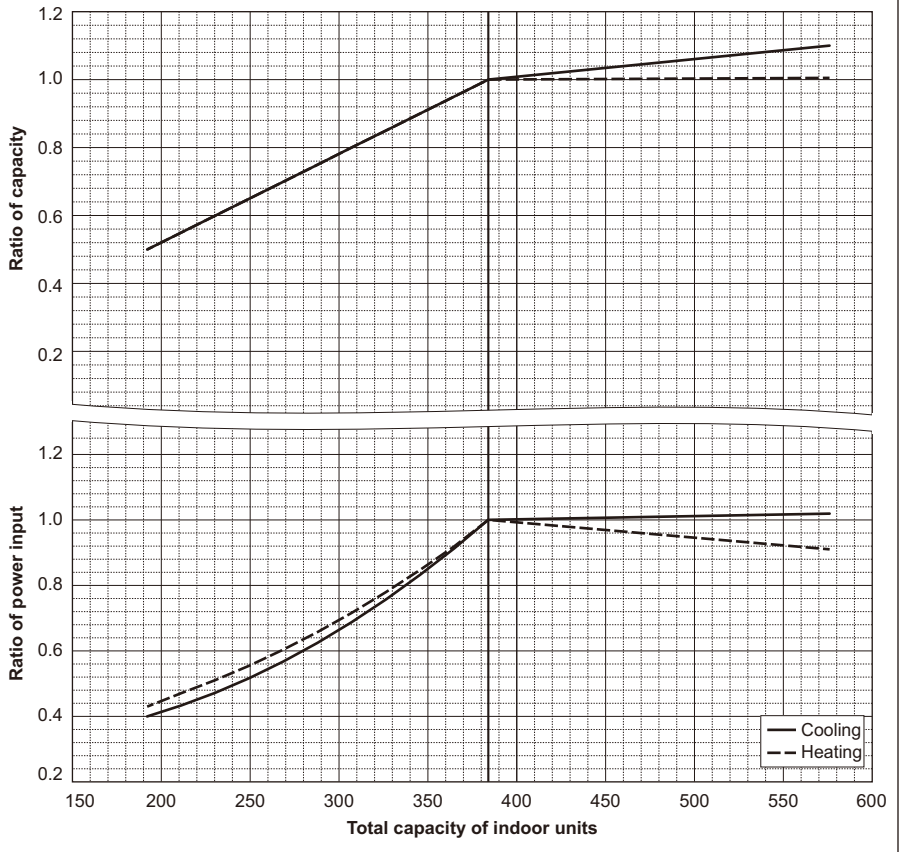

PURY-EP-T(S)NU-A, Y(S)NU-A

PURY-		EP432TSNU/YSNU	
		Non-Ducted	Ducted
Nominal cooling capacity	BTU/h	432,000	
	kW	126.6	
	Input kW	42.36	

PURY-		EP432TSNU/YSNU	
		Non-Ducted	Ducted
Nominal Heating capacity	BTU/h	480,000	
	kW	140.7	
	Input kW	43.14	

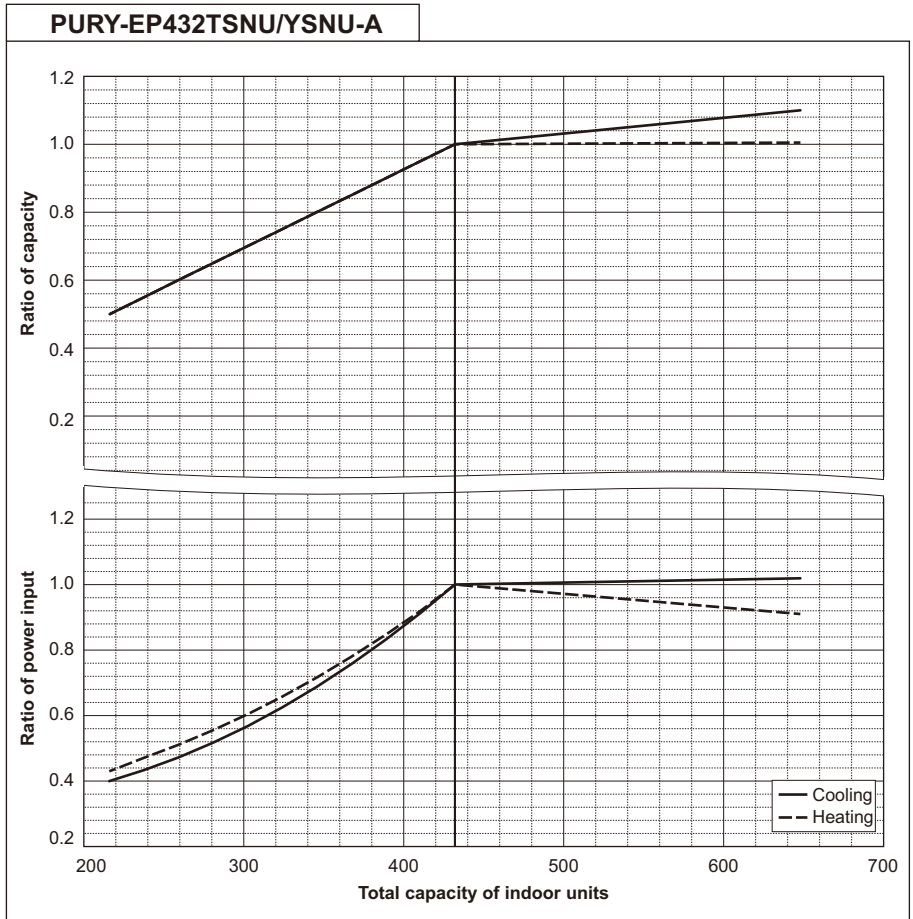

8-4. Correction by refrigerant piping length

CITY MULTI system can extend the piping flexibly within its limitation for the actual situation. However, a decrease of cooling/heating capacity could happen correspondently. Using following correction factor according to the equivalent length of the piping shown at 8-4-1 and 8-4-2, the capacity can be observed. 8-4-3 shows how to obtain the equivalent length of piping.

8-4-1. Cooling capacity correction

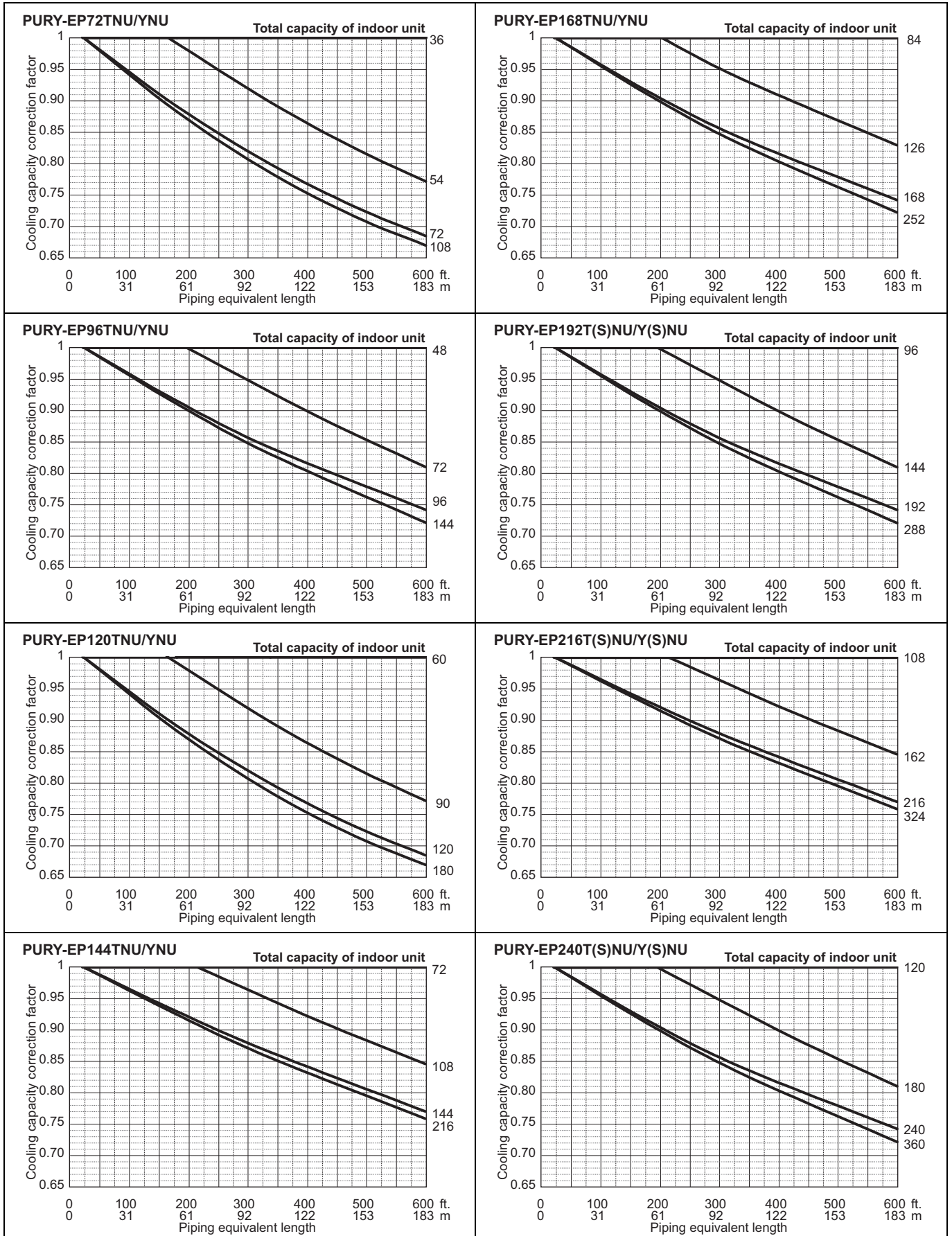

8. CAPACITY TABLES

R2-Series (High efficiency)

PURY-EP-T(S)NU-A, Y(S)NU-A

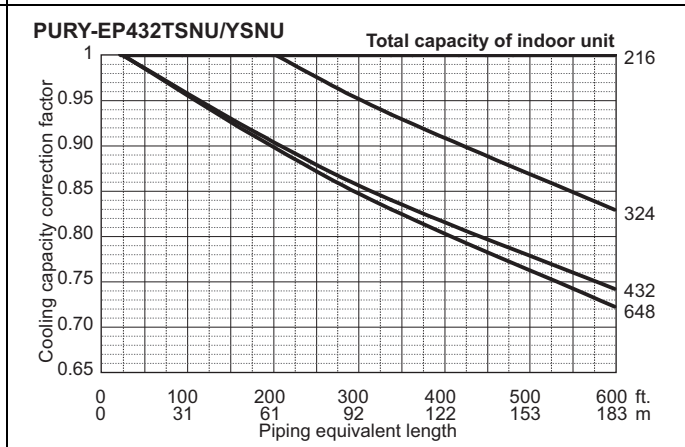
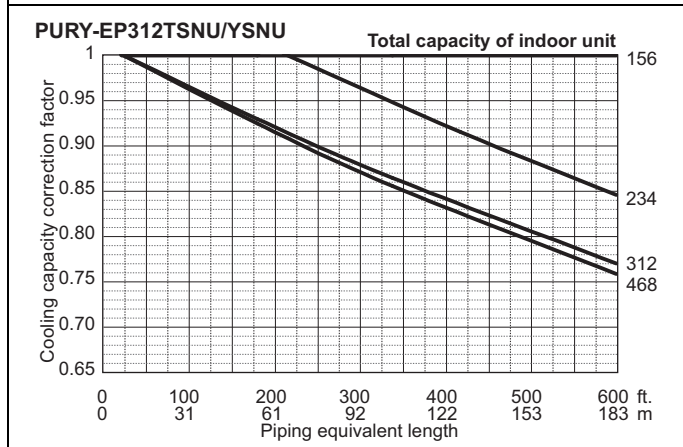
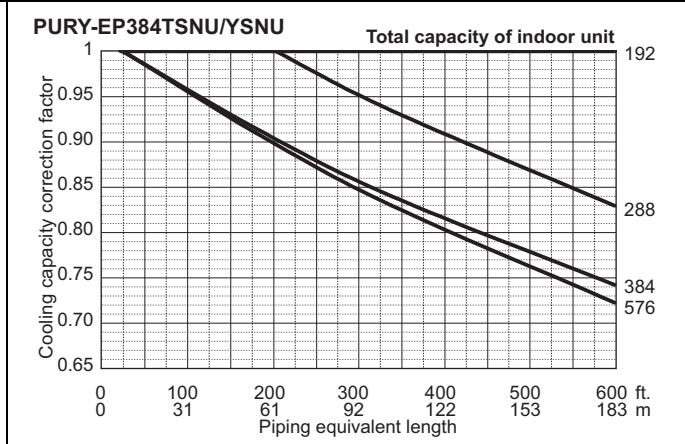
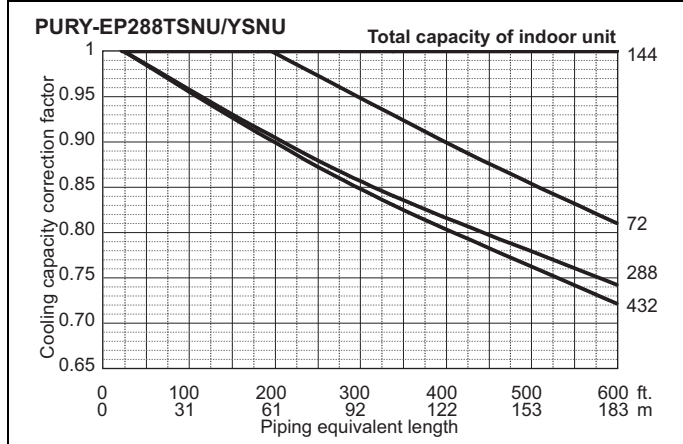
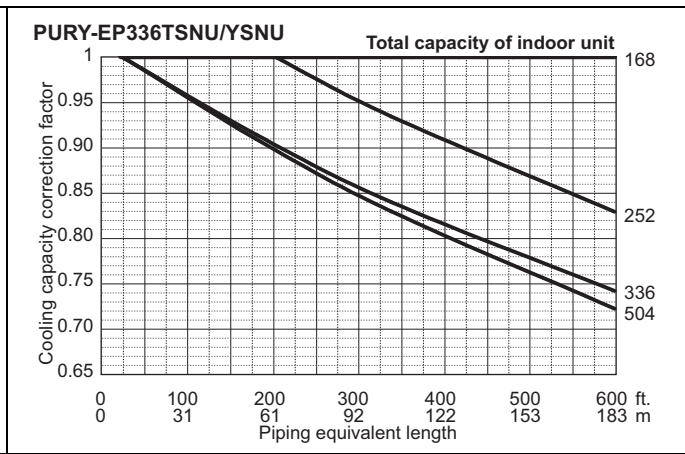
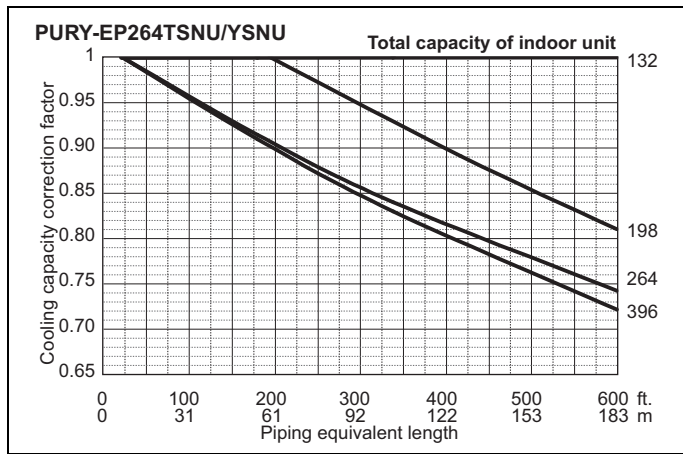

8-4-2. Heating capacity correction

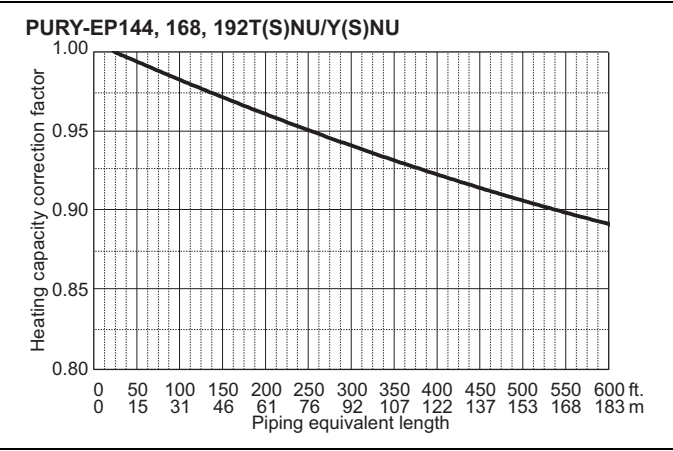
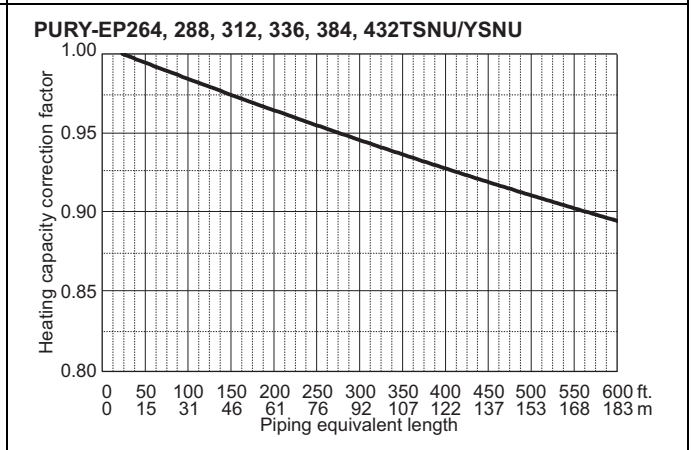
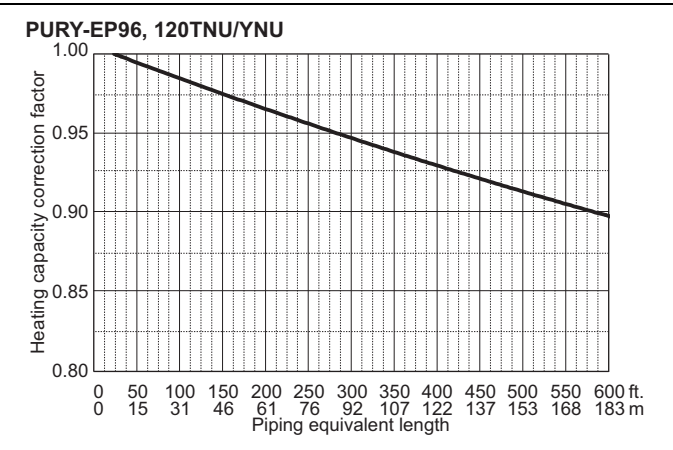
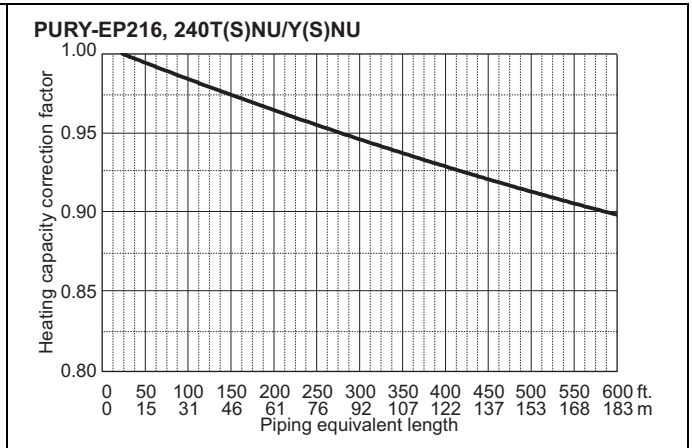
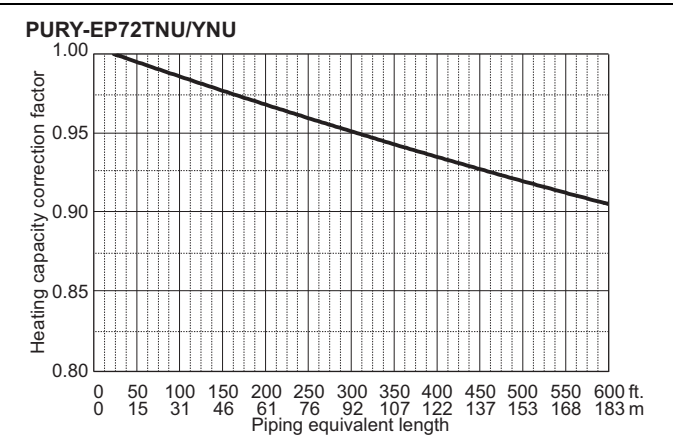

PURY-EP-T(S)NU-A, Y(S)NU-A

8-4-3. How to obtain the equivalent piping length**1. PURY-EP72TNU/YNU**

Equivalent length = (Actual piping length to the farthest indoor unit) + (1.15 x number of bent on the piping) [ft.]

Equivalent length = (Actual piping length to the farthest indoor unit) + (0.35 x number of bent on the piping) [m]

2. PURY-EP96TNU/YNU

Equivalent length = (Actual piping length to the farthest indoor unit) + (1.38 x number of bent on the piping) [ft.]

Equivalent length = (Actual piping length to the farthest indoor unit) + (0.42 x number of bent on the piping) [m]

3. PURY-EP120TNU/YNU

Equivalent length = (Actual piping length to the farthest indoor unit) + (1.64 x number of bent on the piping) [ft.]

Equivalent length = (Actual piping length to the farthest indoor unit) + (0.50 x number of bent on the piping) [m]

4. PURY-EP144TNU/YNU

Equivalent length = (Actual piping length to the farthest indoor unit) + (1.64 x number of bent on the piping) [ft.]

Equivalent length = (Actual piping length to the farthest indoor unit) + (0.50 x number of bent on the piping) [m]

5. PURY-EP168TNU/YNU

Equivalent length = (Actual piping length to the farthest indoor unit) + (1.64 x number of bent on the piping) [ft.]

Equivalent length = (Actual piping length to the farthest indoor unit) + (0.50 x number of bent on the piping) [m]

6. PURY-EP192T(S)NU/Y(S)NU

Equivalent length = (Actual piping length to the farthest indoor unit) + (1.64 x number of bent on the piping) [ft.]

Equivalent length = (Actual piping length to the farthest indoor unit) + (0.50 x number of bent on the piping) [m]

7. PURY-EP216T(S)NU/Y(S)NU

Equivalent length = (Actual piping length to the farthest indoor unit) + (2.30 x number of bent on the piping) [ft.]

Equivalent length = (Actual piping length to the farthest indoor unit) + (0.70 x number of bent on the piping) [m]

8. PURY-EP240T(S)NU/Y(S)NU

Equivalent length = (Actual piping length to the farthest indoor unit) + (2.30 x number of bent on the piping) [ft.]

Equivalent length = (Actual piping length to the farthest indoor unit) + (0.70 x number of bent on the piping) [m]

9. PURY-EP264TSNU/YSNU

Equivalent length = (Actual piping length to the farthest indoor unit) + (2.30 x number of bent on the piping) [ft.]

Equivalent length = (Actual piping length to the farthest indoor unit) + (0.70 x number of bent on the piping) [m]

10. PURY-EP288TSNU/YSNU

Equivalent length = (Actual piping length to the farthest indoor unit) + (2.30 x number of bent on the piping) [ft.]

Equivalent length = (Actual piping length to the farthest indoor unit) + (0.70 x number of bent on the piping) [m]

11. PURY-EP312, 336, 384, 432TSNU/YSNU

Equivalent length = (Actual piping length to the farthest indoor unit) + (2.63 x number of bent on the piping) [ft.]

Equivalent length = (Actual piping length to the farthest indoor unit) + (0.80 x number of bent on the piping) [m]

8-5. Correction at frost and defrost

Due to frost at the outdoor heat exchanger and the automatic defrost operation, the heating capacity of the outdoor unit can be calculated by multiplying the correction factor shown in the table below.

Table of correction factor at frost and defrost

Outdoor inlet air temp. °CWB	6	4	2	1	0	-2	-4	-6	-8	-10	-20
Outdoor inlet air temp. °FWB	43	39	36	34	32	28	25	21	18	14	-4
PURY-EP72TNU-A (-BS)	1.00	0.95	0.84	0.83	0.83	0.87	0.90	0.95	0.95	0.95	0.95
PURY-EP96TNU-A (-BS)	1.00	0.95	0.84	0.83	0.83	0.87	0.90	0.95	0.95	0.95	0.95
PURY-EP120TNU-A (-BS)	1.00	0.93	0.82	0.80	0.82	0.86	0.90	0.90	0.95	0.95	0.95
PURY-EP144TNU-A (-BS)	1.00	0.93	0.82	0.80	0.82	0.86	0.90	0.90	0.95	0.95	0.95
PURY-EP168TNU-A (-BS)	1.00	0.93	0.82	0.80	0.82	0.86	0.90	0.90	0.95	0.95	0.95
PURY-EP192TNU-A (-BS)	1.00	0.93	0.82	0.80	0.82	0.86	0.90	0.90	0.95	0.95	0.95
PURY-EP216TNU-A (-BS)	1.00	0.93	0.82	0.80	0.82	0.86	0.90	0.90	0.95	0.95	0.95
PURY-EP240TNU-A (-BS)	1.00	0.93	0.82	0.80	0.82	0.86	0.90	0.90	0.95	0.95	0.95
PURY-EP192TSNU-A (-BS)	1.00	0.98	0.89	0.86	0.89	0.90	0.92	0.95	0.95	0.95	0.95
PURY-EP216TSNU-A (-BS)	1.00	0.94	0.87	0.86	0.87	0.88	0.90	0.90	0.93	0.95	0.95
PURY-EP240TSNU-A (-BS)	1.00	0.94	0.87	0.86	0.87	0.88	0.90	0.90	0.93	0.95	0.95
PURY-EP264TSNU-A (-BS)	1.00	0.98	0.89	0.88	0.89	0.90	0.92	0.95	0.95	0.95	0.95
PURY-EP288TSNU-A (-BS)	1.00	0.98	0.89	0.88	0.89	0.90	0.92	0.95	0.95	0.95	0.95
PURY-EP312TSNU-A (-BS)	1.00	0.98	0.89	0.88	0.89	0.90	0.92	0.95	0.95	0.95	0.95
PURY-EP336TSNU-A (-BS)	1.00	0.94	0.87	0.86	0.87	0.88	0.90	0.90	0.93	0.95	0.95
PURY-EP384TSNU-A (-BS)	1.00	0.92	0.79	0.77	0.79	0.84	0.88	0.88	0.94	0.94	0.94
PURY-EP432TSNU-A (-BS)	1.00	0.92	0.79	0.77	0.79	0.84	0.88	0.88	0.94	0.94	0.94
PURY-EP72YNU-A (-BS)	1.00	0.95	0.84	0.83	0.83	0.87	0.90	0.95	0.95	0.95	0.95
PURY-EP96YNU-A (-BS)	1.00	0.95	0.84	0.83	0.83	0.87	0.90	0.95	0.95	0.95	0.95
PURY-EP120YNU-A (-BS)	1.00	0.93	0.82	0.80	0.82	0.86	0.90	0.90	0.95	0.95	0.95
PURY-EP144YNU-A (-BS)	1.00	0.93	0.82	0.80	0.82	0.86	0.90	0.90	0.95	0.95	0.95
PURY-EP168YNU-A (-BS)	1.00	0.93	0.82	0.80	0.82	0.86	0.90	0.90	0.95	0.95	0.95
PURY-EP192YNU-A (-BS)	1.00	0.93	0.82	0.80	0.82	0.86	0.90	0.90	0.95	0.95	0.95
PURY-EP216YNU-A (-BS)	1.00	0.93	0.82	0.80	0.82	0.86	0.90	0.90	0.95	0.95	0.95
PURY-EP240YNU-A (-BS)	1.00	0.93	0.82	0.80	0.82	0.86	0.90	0.90	0.95	0.95	0.95
PURY-EP192YSNU-A (-BS)	1.00	0.98	0.89	0.86	0.89	0.90	0.92	0.95	0.95	0.95	0.95
PURY-EP216YSNU-A (-BS)	1.00	0.94	0.87	0.86	0.87	0.88	0.90	0.90	0.93	0.95	0.95
PURY-EP240YSNU-A (-BS)	1.00	0.94	0.87	0.86	0.87	0.88	0.90	0.90	0.93	0.95	0.95
PURY-EP264YSNU-A (-BS)	1.00	0.98	0.89	0.88	0.89	0.90	0.92	0.95	0.95	0.95	0.95
PURY-EP288YSNU-A (-BS)	1.00	0.98	0.89	0.88	0.89	0.90	0.92	0.95	0.95	0.95	0.95
PURY-EP312YSNU-A (-BS)	1.00	0.98	0.89	0.88	0.89	0.90	0.92	0.95	0.95	0.95	0.95
PURY-EP336YSNU-A (-BS)	1.00	0.94	0.87	0.86	0.87	0.88	0.90	0.90	0.93	0.95	0.95
PURY-EP384YSNU-A (-BS)	1.00	0.92	0.79	0.77	0.79	0.84	0.88	0.88	0.94	0.94	0.94
PURY-EP432YSNU-A (-BS)	1.00	0.92	0.79	0.77	0.79	0.84	0.88	0.88	0.94	0.94	0.94

Note

- ♦ The high humidity condition (e.g., a foggy atmosphere) which causes frost forming on the heat exchanger will worsen the heating performance of the unit.
- ♦ The snow blowing to the heat exchanger will worsen the heating performance of the unit. Install a snow hood as a preventive measure.
- ♦ The correction factors in the table above are used for a full-load and above.
Use the formula below to calculate the correction factor to use for a partial load.

Correction factor for partial load: K

Correction factor for a full load and above: K_0

Partial load factor: A

$$K = 1 - (1 - K_0) \times A$$

8-6. Correction at evaporation-temperature (ET) control

When the target evaporation temperature is changed, the capacity or the power input can be calculated by multiplying the correction factor shown in the table below.

ET *1	°C	6	9	11	14
	°F	43	48	52	57
Correction factor	Capacity	0.90	0.83	0.71	0.55
	Power Input	0.90	0.72	0.54	0.36

*1 The evaporation temperature in operation may be different from the preset target evaporation temperature because it depends on such factors as the unit protection control.
The capacity and power input could also fluctuate.

*2 Use the table above which indicates the unit properties as a reference

9-1. JOINT and REDUCER

CITY MULTI units can be easily connected by using Joint sets and Reducer sets provided by Mitsubishi Electric. Refer to section "Piping Design" or the Installation Manual that comes with the Joint set or Reducer set for how to install the Joint set or Reducer set.

CMY-Y102SS-G2

For Gas pipe:

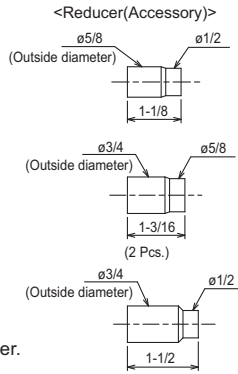
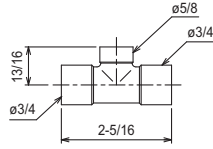

*Pipe diameter is indicated by inside diameter.

For Liquid pipe:

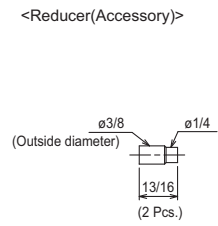
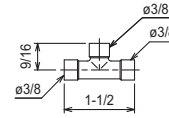

in.

CMY-Y102LS-G2

For Gas pipe:

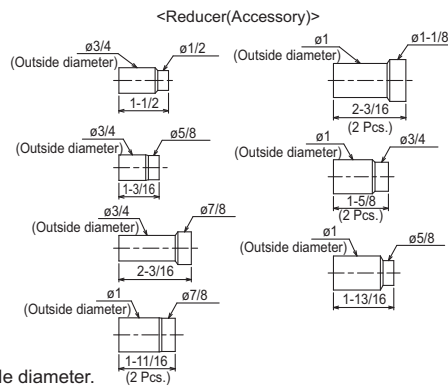
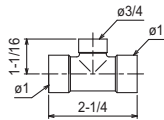

*Pipe diameter is indicated by inside diameter.

For Liquid pipe:

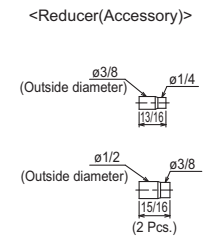
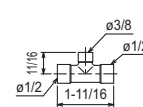

in.

CMY-R201S-G

For High pressure

For Low pressure

For Liquid line

in.

<Accessory>
• Cover3 Pcs.
Note. Pipe diameter is indicated by inside diameter.

CMY-R202S-G

For High pressure

For Low pressure

For Liquid line

in.

<Accessory>
• Cover3 Pcs.
Note. Pipe diameter is indicated by inside diameter.

CMY-R203S-G

For High pressure

For Low pressure

For Liquid line

in.

<Accessory>
• Cover3 Pcs.
Note. Pipe diameter is indicated by inside diameter.

PURV-EP-T(S)NU-A, Y(S)NU-A

CMY-R303S-G1 in.

Row 1: $\phi 1-1/8$ (Outside diameter), $\phi 7/8$ (Pipe diameter), $3-3/16$ (2 Pcs.)

Row 2: $\phi 3/4$ (Outside diameter), $\phi 5/8$ (Pipe diameter), $3-3/16$ (2 Pcs.)

Row 3: $\phi 1-3/8$ (Outside diameter), $\phi 1-1/8$ (Pipe diameter), $1-31/32$

Row 4: $\phi 7/8$ (Outside diameter), $\phi 3/4$ (Pipe diameter), $3-3/16$ (2 Pcs.)

Row 5: $\phi 3/4$ (Outside diameter), $\phi 1/2$ (Pipe diameter), $3-3/16$

Row 6: $\phi 1/2$ (Outside diameter), $\phi 3/8$ (Pipe diameter), $3-3/16$

Row 7: $\phi 1-1/2$ (Outside diameter), $\phi 1-3/8$ (Pipe diameter), $2-3/4$

Note. Pipe diameter is indicated by inside diameter.

CMY-R304S-G1 in.

Row 1: $\phi 1-3/8$ (Outside diameter), $\phi 1-1/8$ (Pipe diameter), $1-31/32$ (2 Pcs.)

Row 2: $\phi 1-1/2$ (Outside diameter), $\phi 1-5/8$ (Pipe diameter), $2-3/4$

Row 3: $\phi 1-1/2$ (Outside diameter), $\phi 1-3/8$ (Pipe diameter), $2-3/4$

Row 4: $\phi 1-1/8$ (Outside diameter), $\phi 7/8$ (Pipe diameter), $3-3/16$ (2 Pcs.)

Row 5: $\phi 7/8$ (Outside diameter), $\phi 3/4$ (Pipe diameter), $3-3/16$ (2 Pcs.)

Row 6: $\phi 3/4$ (Outside diameter), $\phi 5/8$ (Pipe diameter), $3-3/16$

Note. Pipe diameter is indicated by inside diameter.

CMY-R305S-G1 in.

Row 1: $\phi 1-1/8$ (Outside diameter), $\phi 7/8$ (Pipe diameter), $3-3/16$ (2 Pcs.)

Row 2: $\phi 7/8$ (Outside diameter), $\phi 3/4$ (Pipe diameter), $3-3/16$ (2 Pcs.)

Row 3: $\phi 1-3/8$ (Outside diameter), $\phi 1-1/8$ (Pipe diameter), $1-31/32$ (2 Pcs.)

Row 4: $\phi 3/4$ (Outside diameter), $\phi 5/8$ (Pipe diameter), $3-3/16$ (2 Pcs.)

Row 5: $\phi 3/4$ (Outside diameter), $\phi 1/2$ (Pipe diameter), $3-3/16$

Row 6: $\phi 1/2$ (Outside diameter), $\phi 3/8$ (Pipe diameter), $3-3/16$

Row 7: $\phi 1-1/2$ (Outside diameter), $\phi 1-3/8$ (Pipe diameter), $2-3/4$

Note. Pipe diameter is indicated by inside diameter.

CMY-R306S-G in.

Row 1: $\phi 3/4$ (Outside diameter), $\phi 5/8$ (Pipe diameter), $3-3/16$

Row 2: $\phi 7/8$ (Outside diameter), $\phi 7/8$ (Pipe diameter), $3-3/16$

Row 3: $\phi 7/8$ (Outside diameter), $\phi 3/4$ (Pipe diameter), $3-3/16$

Row 4: $\phi 1-1/8$ (Outside diameter), $\phi 7/8$ (Pipe diameter), $3-3/16$

Row 5: $\phi 5/8$ (Outside diameter), $\phi 1/2$ (Pipe diameter), $3-3/16$

Row 6: $\phi 5/8$ (Outside diameter), $\phi 3/8$ (Pipe diameter), $3-3/16$

Note. Pipe diameter is indicated by inside diameter.

9-3. JOINT KIT "CMY-R160-J1" FOR BC CONTROLLER

Joint kit "CMY-R160-J1" for BC controller is used to combine 2 ports of the BC controller at a PURY/PQRY system so as to enable down-stream Indoor capacity above P54 as shown in Fig. 1.

The Joint kit include following items:

① Instruction	② Joint pipe (Small)	③ Joint pipe (Large)	④ Cover 1	⑤ Cover 2	⑥ Cover 3	⑦ Band	⑧ Reducer 1	⑨ Reducer 2
This sheet 1pc	1pc	1pc	2pcs	1pc for gas side	1pc for liquid side	8pcs	OD19.05-ID22.2 1pc	OD19.05-ID15.88 1pc

Please prepare the following items in the field. ① Tape for insulation material sealing ② Extension pipe for refrigerant circuit

② Joint pipe (for liquid side)

③ Joint pipe (for gas side)

mm (in.)

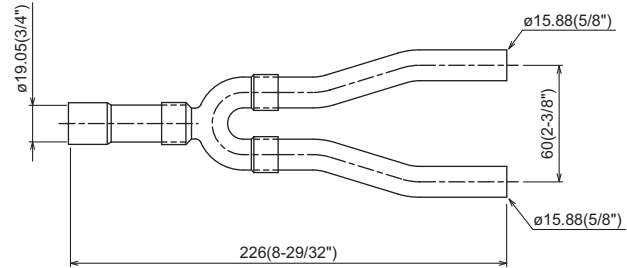
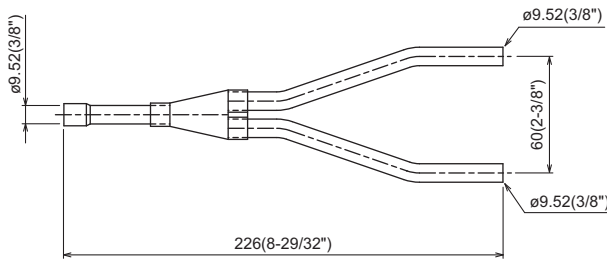

1. Designing CMY-R160-J1 to a PURY/PQRY system

The maximum down-stream Indoor capacity for 1 port of BC controller is P54. When the down-stream Indoor capacity is above P54, Joint kit CMY-R160-J1 is needed to combined 2 ports of BC controller to enlarge the capacity, like Group 2 and 3 in Fig. 1.

Maximum 3 Indoor units are allowed to connect to 1 port of BC controller or 2 combined ports of BC controller using CMY-R160-J1.

When connecting Indoor units to 1 port of BC controller or 2 combined ports of BC controller using CMY-R160-J1 or CMY-Y102SS-G2 is applicable, like Group 1 and 2 in Fig. 1

Caution: Mixed cooling and heating mode at the same time for Indoor units connecting to 1 port or 2 combined ports is not available.

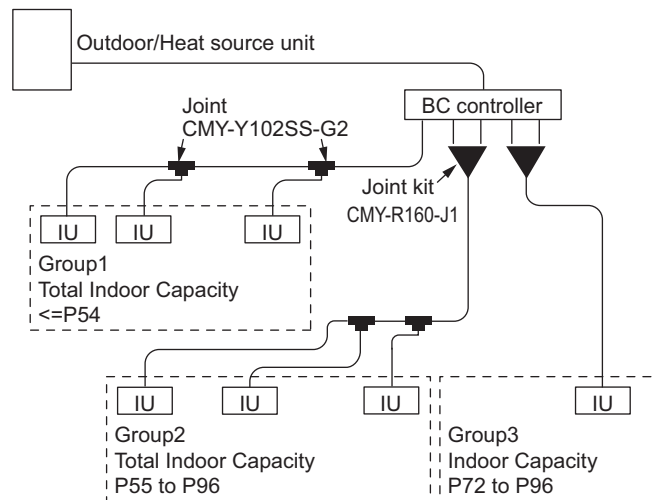

Fig.1. CMY-R160-J1 applying scheme

2. Piping at the installation site

The connection of CMY-R160-J1 to BC controller and pipe leading to Indoor units is referable to Fig. 2. Non-oxidized brazing is necessary. All piping must be careful to avoid foreign material getting inside.

After piping and air-tight testing, insulation work to the Joint and pipe should be done. Details is available at the Installation Manual.

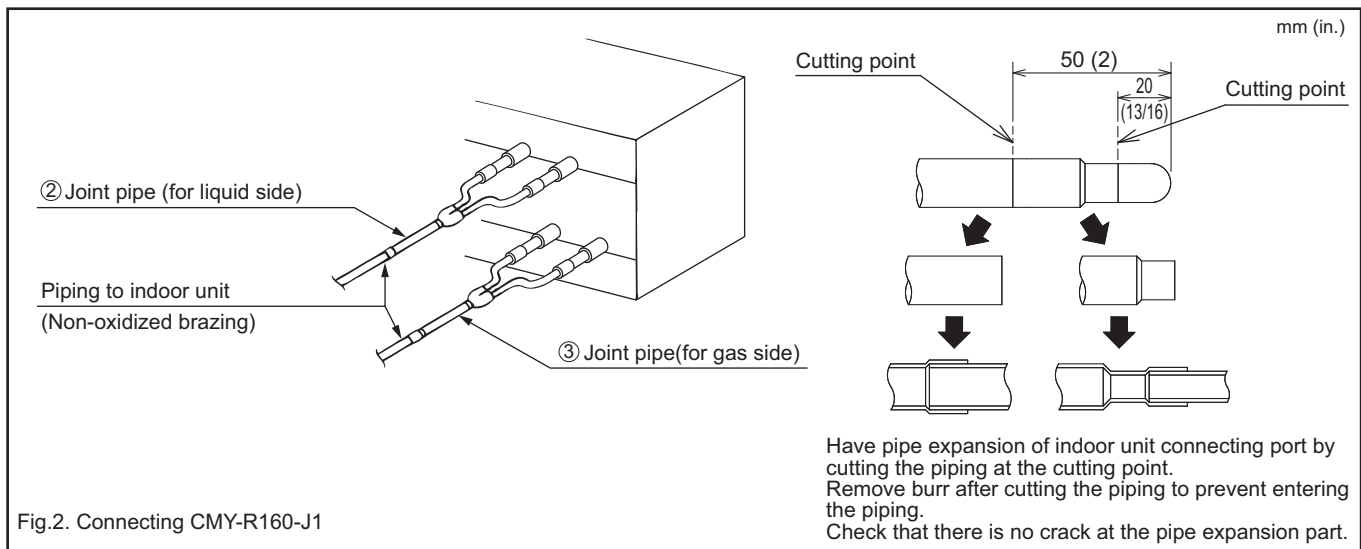
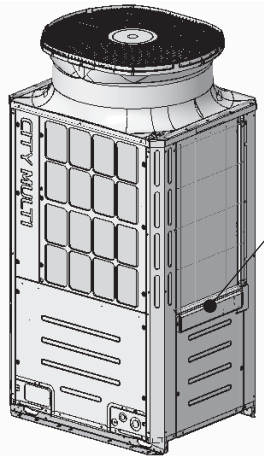

Fig.2. Connecting CMY-R160-J1

9-4. PANEL HEATER

If there is a risk that the drain water will freeze inside the outdoor unit, the installation of a panel heater is recommended. For details, refer to the panel heater Installation Manual.

PAC-PH01EHYU-E (for S module)



Front view

PANEL HEATER R

PANEL HEATER B

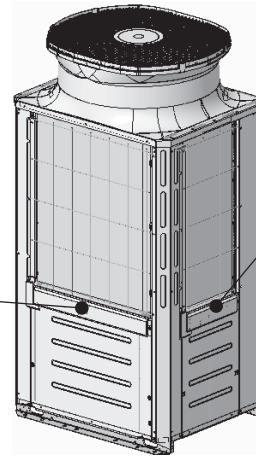

Rear view

PANEL HEATER L

PAC-PH02EHYU-E (for L module)

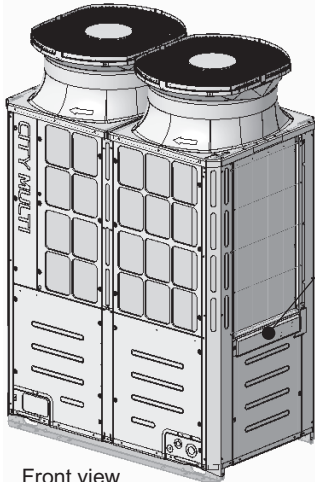

Front view

PANEL HEATER R

PANEL HEATER BR

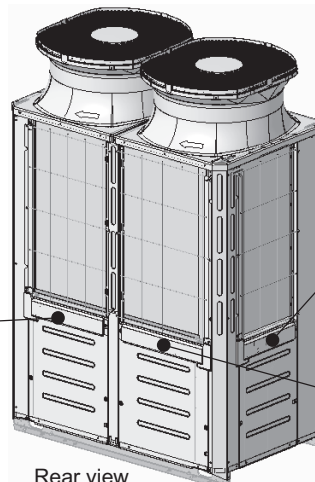

Rear view

PANEL HEATER L

PANEL HEATER BL

PAC-PH03EHYU-E1 (for XL module)

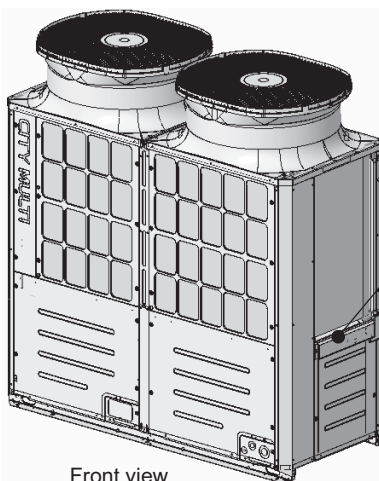

Front view

PANEL HEATER R

PANEL HEATER BR

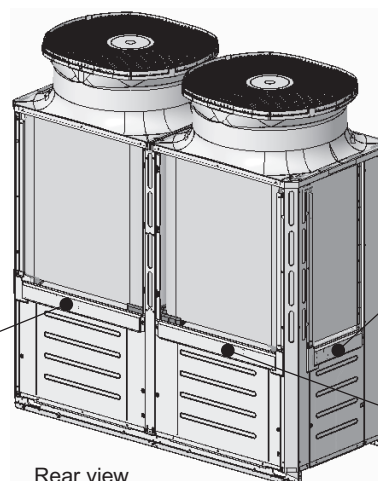

Rear view

PANEL HEATER L

PANEL HEATER BL

PAC-PH03EHYU-E1 (for EXL module)

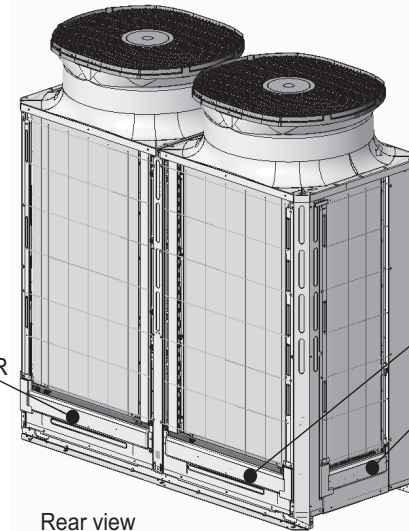
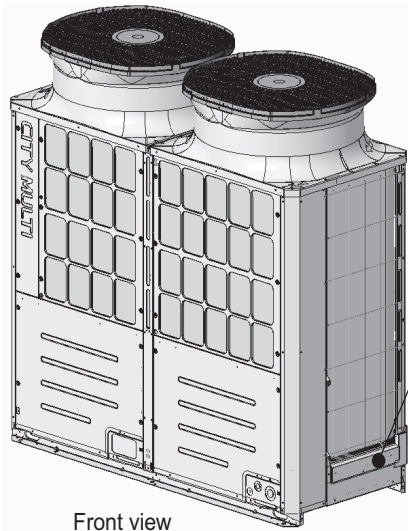

PANEL HEATER R

PANEL HEATER BR

PANEL HEATER BL

PANEL HEATER L

10-1. General cautions

- ① Follow ordinance of your governmental organization for technical standard related to electrical equipment, wiring regulations, and guidance of each electric power company.
- ② Wiring for control (hereinafter referred to as transmission cable) shall be (50mm[1-5/8in] or more) apart from power source wiring so that it is not influenced by electric noise from power source wiring. (Do not insert transmission cable and power source wire in the same conduit.)
- ③ Be sure to provide designated grounding work to outdoor unit.
- ④ Give some allowance to wiring for electrical part box of indoor and outdoor units, because the box is sometimes removed at the time of service work.
- ⑤ Never connect 100V, 208~230, 460V power source to terminal block of transmission cable. If connected, electrical parts will be damaged.
- ⑥ Use 2-core shield cable for transmission cable. If transmission cables of different systems are wired with the same multiple-core cable, the resultant poor transmitting and receiving will cause erroneous operations.
- ⑦ When extending the transmission line, make sure to extend the shield cable as well.

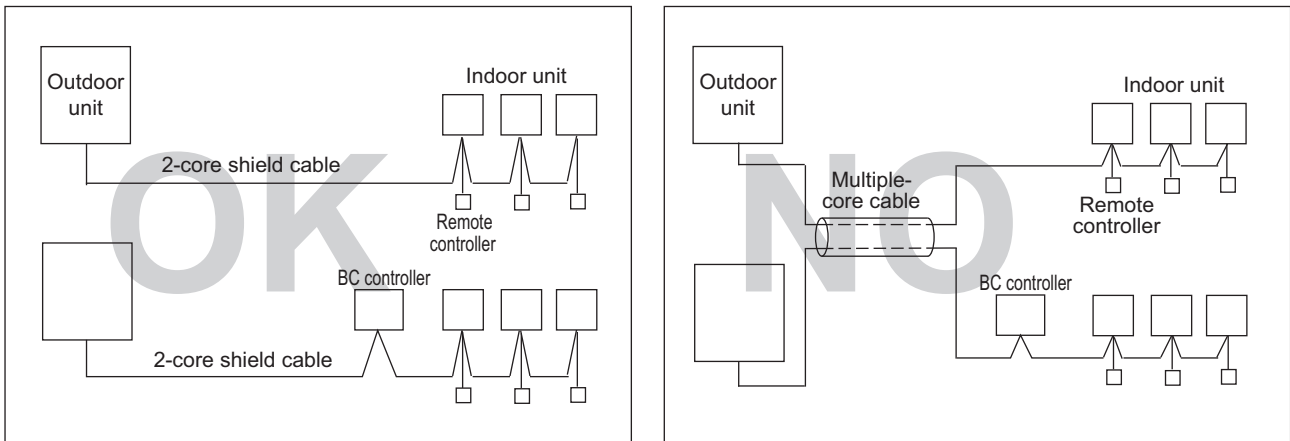

10-2. Power supply for Outdoor unit

10-2-1. Electrical characteristics of Outdoor unit at cooling mode

Symbols: MCA: Minimum Circuit Ampacity

SC: Starting Current

MOP: Maximum Overcurrent Protection

PURY-EP-T(S)NU

Model	Unit combination	Outdoor units			Compressor		Fan		
		Hz	Volts	Voltage range	MCA(A)	MOP(A)	Output (kW)	SC(A)	Output (kW)
PURY-EP72TNU-A(-BS)	-	60Hz	208/230V	188 to 253V	33/30	50/50	3.8	15	0.92
PURY-EP96TNU-A(-BS)	-				44/40	70/60	5.5	15	0.46+0.46
PURY-EP120TNU-A(-BS)	-				56/55	90/90	7.6	15	0.46+0.46
PURY-EP144TNU-A(-BS)	-				60/60	100/100	9.8	15	0.46+0.46
PURY-EP168TNU-A(-BS)	-				70/70	110/110	12.2	15	0.92+0.92
PURY-EP192TNU-A(-BS)	-				80/75	125/125	13.2	15	0.92+0.92
PURY-EP216TNU-A(-BS)	-				88/85	150/150	15.8	15	0.92+0.92
PURY-EP240TNU-A(-BS)	-				88/88	150/150	17.0	15	0.92+0.92
PURY-EP192TSNU-A(-BS)	PURY-EP96TNU-A(-BS)				44/40	70/60	5.5	15	0.46+0.46
	PURY-EP96TNU-A(-BS)				44/40	70/60	5.5	15	0.46+0.46
PURY-EP216TSNU-A(-BS)	PURY-EP120TNU-A(-BS)				56/55	90/90	7.6	15	0.46+0.46
	PURY-EP96TNU-A(-BS)				44/40	70/60	5.5	15	0.46+0.46
PURY-EP240TSNU-A(-BS)	PURY-EP120TNU-A(-BS)				56/55	90/90	7.6	15	0.46+0.46
	PURY-EP120TNU-A(-BS)				56/55	90/90	7.6	15	0.46+0.46
PURY-EP264TSNU-A(-BS)	PURY-EP144TNU-A(-BS)				60/60	100/100	9.8	15	0.46+0.46
	PURY-EP120TNU-A(-BS)				56/55	90/90	7.6	15	0.46+0.46
PURY-EP288TSNU-A(-BS)	PURY-EP144TNU-A(-BS)				60/60	100/100	9.8	15	0.46+0.46
	PURY-EP144TNU-A(-BS)				60/60	100/100	9.8	15	0.46+0.46
PURY-EP312TSNU-A(-BS)	PURY-EP168TNU-A(-BS)				70/70	110/110	12.2	15	0.92+0.92
	PURY-EP144TNU-A(-BS)				60/60	100/100	9.8	15	0.46+0.46
PURY-EP336TSNU-A(-BS)	PURY-EP168TNU-A(-BS)				70/70	110/110	12.2	15	0.92+0.92
	PURY-EP168TNU-A(-BS)				70/70	110/110	12.2	15	0.92+0.92
PURY-EP384TSNU-A(-BS)	PURY-EP192TNU-A(-BS)				80/75	125/125	13.2	15	0.92+0.92
	PURY-EP192TNU-A(-BS)				80/75	125/125	13.2	15	0.92+0.92
PURY-EP432TSNU-A(-BS)	PURY-EP216TNU-A(-BS)				88/85	150/150	15.8	15	0.92+0.92
	PURY-EP216TNU-A(-BS)				88/85	150/150	15.8	15	0.92+0.92

Symbols: MCA: Minimum Circuit Ampacity

SC: Starting Current

MOP: Maximum Overcurrent Protection

PURY-EP-Y(S)NU

Model	Unit combination	Outdoor units			Compressor		Fan		
		Hz	Volts	Voltage range	MCA(A)	MOP(A)	Output (kW)	SC(A)	Output (kW)
PURY-EP72YNU-A(-BS)	-	60Hz	460V	414 to 506V	14	20	3.8	7	0.92
PURY-EP96YNU-A(-BS)	-				20	30	5.5	7	0.46+0.46
PURY-EP120YNU-A(-BS)	-				26	40	7.6	7	0.46+0.46
PURY-EP144YNU-A(-BS)	-				34	50	9.8	7	0.46+0.46
PURY-EP168YNU-A(-BS)	-				35	50	12.2	7	0.92+0.92
PURY-EP192YNU-A(-BS)	-				38	60	13.2	7	0.92+0.92
PURY-EP216YNU-A(-BS)	-				41	70	15.8	7	0.92+0.92
PURY-EP240YNU-A(-BS)	-				41	70	17.0	7	0.92+0.92
PURY-EP192YSNU-A(-BS)	PURY-EP96YNU-A(-BS)				20	30	5.5	7	0.46+0.46
	PURY-EP96YNU-A(-BS)				20	30	5.5	7	0.46+0.46
PURY-EP216YSNU-A(-BS)	PURY-EP120YNU-A(-BS)				26	40	7.6	7	0.46+0.46
	PURY-EP96YNU-A(-BS)				20	30	5.5	7	0.46+0.46
PURY-EP240YSNU-A(-BS)	PURY-EP120YNU-A(-BS)				26	40	7.6	7	0.46+0.46
	PURY-EP120YNU-A(-BS)				26	40	7.6	7	0.46+0.46
PURY-EP264YSNU-A(-BS)	PURY-EP144YNU-A(-BS)				34	50	9.8	7	0.46+0.46
	PURY-EP120YNU-A(-BS)				26	40	7.6	7	0.46+0.46
PURY-EP288YSNU-A(-BS)	PURY-EP144YNU-A(-BS)				34	50	9.8	7	0.46+0.46
	PURY-EP144YNU-A(-BS)				34	50	9.8	7	0.46+0.46
PURY-EP312YSNU-A(-BS)	PURY-EP168YNU-A(-BS)				35	50	12.2	7	0.92+0.92
	PURY-EP144YNU-A(-BS)				34	50	9.8	7	0.46+0.46
PURY-EP336YSNU-A(-BS)	PURY-EP168YNU-A(-BS)				35	50	12.2	7	0.92+0.92
	PURY-EP168YNU-A(-BS)				35	50	12.2	7	0.92+0.92
PURY-EP384YSNU-A(-BS)	PURY-EP192YNU-A(-BS)				38	60	13.2	7	0.92+0.92
	PURY-EP192YNU-A(-BS)				38	60	13.2	7	0.92+0.92
PURY-EP432YSNU-A(-BS)	PURY-EP216YNU-A(-BS)				41	70	15.8	7	0.92+0.92
	PURY-EP216YNU-A(-BS)				41	70	15.8	7	0.92+0.92

PURY-EP-T(S)NU-A, Y(S)NU-A

10-3. Power cable specifications

Thickness of wire for main power supply, capacities of the switch and system impedance

3-phase 3-wire, 208/230V, 60Hz		Minimum cable size [mm ² (AWG)]				Breaker for current leakage	
		Main cable		Ground			
		208V	230V	208V	230V	208V	230V
PURY-EP-TNU-A	EP72	8.4 (8)	5.3 (10)	8.4 (8)	5.3 (10)	35A 30mA or 100mA 0.1sec. or less	30A 30mA or 100mA 0.1sec. or less
	EP96	13.3 (6)	13.3 (6)	13.3 (6)	13.3 (6)	45A 100mA 0.1sec. or less	45A 100mA 0.1sec. or less
	EP120	21.2 (4)	21.2 (4)	21.2 (4)	21.2 (4)	60A 100mA 0.1sec. or less	60A 100mA 0.1sec. or less
	EP144	21.2 (4)	21.2 (4)	21.2 (4)	21.2 (4)	60A 100mA 0.1sec. or less	60A 100mA 0.1sec. or less
	EP168	21.2 (4)	21.2 (4)	21.2 (4)	21.2 (4)	70A 100mA 0.1sec. or less	70A 100mA 0.1sec. or less
	EP192	33.6 (2)	33.6 (2)	33.6 (2)	33.6 (2)	80A 100mA 0.1sec. or less	80A 100mA 0.1sec. or less
	EP216	33.6 (2)	33.6 (2)	33.6 (2)	33.6 (2)	90A 100mA 0.1sec. or less	90A 100mA 0.1sec. or less
	EP240	33.6 (2)	33.6 (2)	33.6 (2)	33.6 (2)	90A 100mA 0.1sec. or less	90A 100mA 0.1sec. or less

3-phase 3-wire, 460V, 60Hz		Minimum wire thickness [mm ² (AWG)]			Breaker for current leakage 460V
		Main cable	Branch	Ground	
PURY-EP-YNU-A	EP72	2.1 (14)	-	2.1 (14)	15A 30mA or 100mA 0.1sec. or less
	EP96	3.3 (12)	-	3.3 (12)	20A 30mA or 100mA 0.1sec. or less
	EP120	5.3 (10)	-	5.3 (10)	30A 30mA or 100mA 0.1sec. or less
	EP144	8.4 (8)	-	8.4 (8)	35A 30mA or 100mA 0.1sec. or less
	EP168	8.4 (8)	-	8.4 (8)	40A 100mA 0.1sec. or less
	EP192	8.4 (8)	-	8.4 (8)	40A 100mA 0.1sec. or less
	EP216	13.3 (6)	-	13.3 (6)	50A 100mA 0.1sec. or less
	EP240	13.3 (6)	-	13.3 (6)	50A 100mA 0.1sec. or less

1. Use dedicated power supplies for the outdoor unit. Ensure OC and OS are wired individually.
2. Bear in mind ambient conditions (ambient temperature, direct sunlight, rain water, etc.) when proceeding with the wiring and connections.
3. The wire size is the minimum value for metal conduit wiring. If the voltage drops, use a wire that is one rank thicker in diameter. Make sure the power-supply voltage does not drop more than 10%. Make sure that the voltage imbalance between the phases is 2% or less.
4. Specific wiring requirements should adhere to the wiring regulations of the region.
5. Power supply cords of parts of appliances for outdoor use shall not be lighter than polychloroprene sheathed flexible cord (design 245 IEC57). For example, use wiring such as YZW.
6. A switch with at least 3 mm [1/8 in.] contact separation in each pole shall be provided by the Air Conditioner installer.
7. For details on indoor unit wiring and breaker for current leakage, refer to the indoor unit Instruction Book and Installation Manual.

⚠ WARNING

- ◆ Be sure to use specified wires for connections and ensure no external force is imparted to terminal connections. If connections are not fixed firmly, heating or fire may result.
- ◆ Be sure to use the appropriate type of overcurrent protection switch. Note that generated overcurrent may include some amount of direct current.

⚠ CAUTION

- ◆ The breakers for current leakage should support Inverter circuit. (e.g. Mitsubishi Electric's NV-C-Series or equivalent). If no earth leakage breaker is installed, it may cause an electric shock.
- ◆ Breakers for current leakage should combine using of switch.
- ◆ Do not use anything other than a breaker with the correct capacity. Using a breaker of too large capacity may cause malfunction or fire.
- ◆ If a large electric current flows due to malfunction or faulty wiring, earth-leakage breakers on the unit side and on the upstream side of the power supply system may both operate.
Depending on the importance of the system, separate the power supply system or take protective coordination of breakers.

10-4. Power supply examples

The local standards and/or regulations is applicable at a higher priority.

10-4-1. PURY-EP72, 96, 120, 144, 168, 192, 216, 240TNU/YNU

PURY-EP-T(S)NU-A, Y(S)NU-A

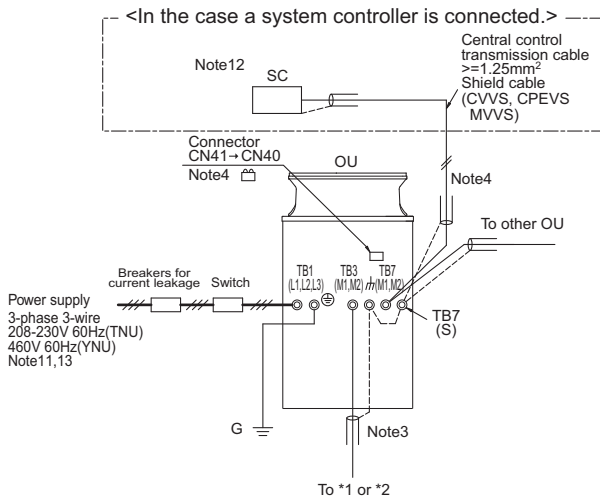

Note:

- The transmission cable is not-polarity double-wire.
- Symbol © means a screw terminal for wiring.
- The shield wire of transmission cable should be connected to the grounding terminal at Outdoor unit. All shield wire of M-Net transmission cable among Indoor units should be connected to the S terminal at Indoor unit or all shield wire should be connected together. The broken line at the scheme means shield wire.
- The connector change from CN41 to CN40 at one of the outdoor units will enable the outdoor unit to supply power to TB7. The transmission cable (above 1.25mm², shielded, CVVS/CPEVS/MVVS) among Outdoor units and system controllers is called central control transmission cable. The shield wire of the central control transmission cable must be grounded at the Outdoor unit whose CN41 is changed to CN40. When the power supply unit PAC-SC51KUA is used, connect the shielded cable to the ground terminal on the PAC-SC51KUA.
- MA R/C transmission cable (0.3-1.25mm²) must be less than 200m in length, while ME R/C transmission cable (0.3-1.25mm²) must be less than 10m in length. But transmission cable to the ME R/C can be extend using a M-NET cable (>=1.25mm²) when the length is counted in the M-Net length.
- To wire PAR-CT01MAU, PAR-40MAAU, and PAC-YT53CRAU, use a wire with a diameter of 0.3mm² [AWG 22].
- MA remote controller and ME remote controller should not be grouped together. When a PAR-CT01MAU or PAR-40MAAU is connected to a group, no other MA remote controllers can be connected to the same group.
- If using 1 or 2 (main/sub) MA remote controller to control more than 1 Indoor unit, use MA transmission cable to connect all the TB15 terminals of the Indoor units. It is called "Grouping". If using 1 or 2 (main/sub) ME remote controller control more than 1 indoor unit, set address to Indoor unit and ME remote controller. For the method, refer to 11-4. "Address setting".
- Indoor board consumes power from TB3. The power balance should be considered according to System Design 11-3. "System configuration restrictions".
- If Transmission booster is needed, be sure to connect the shield wires to the both sides to the booster.
- The critical current for choosing power source equipment is approximate 1.4 times of total rated current of the Outdoor unit(s) or Indoor unit(s).
- When System controller (SC) is connected to the system, turn the SW5-1 on.
- The phases of electricity power must be confirmed to be right used. Phase-reverse, or phase-missing could break the controllers.

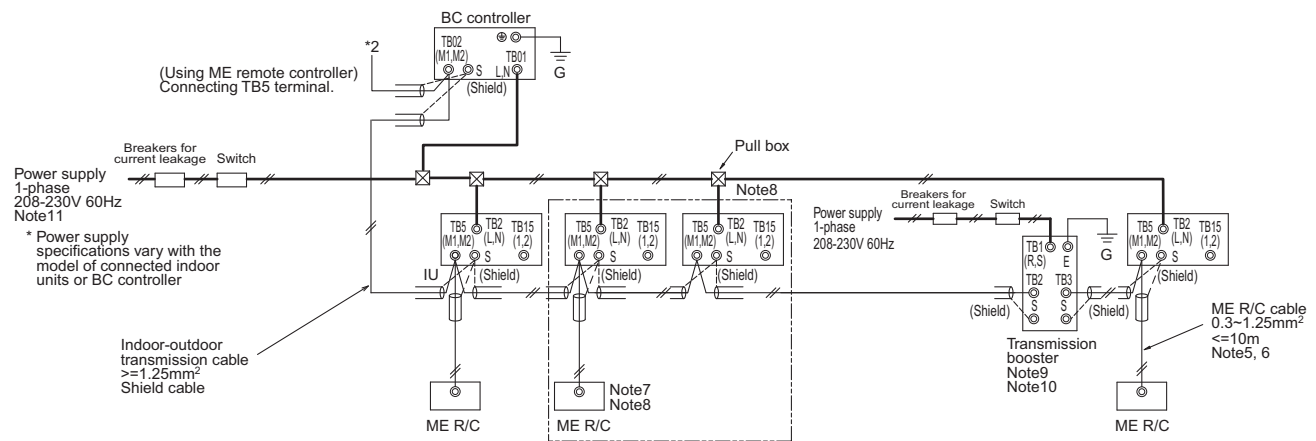
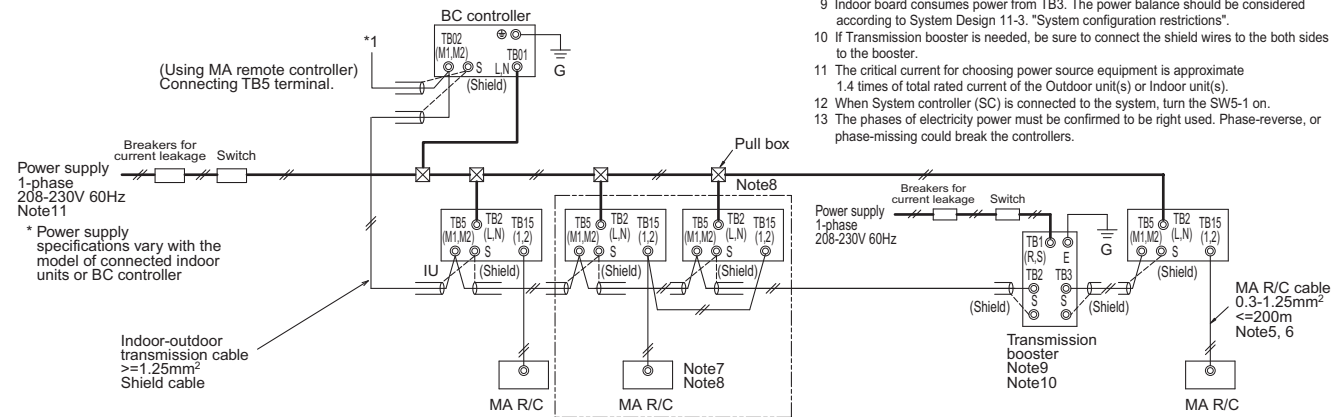

Symbol	Model	Minimum Wire thickness				Breaker for current leakage
		Power wire [mm ² (AWG)]		G wire [mm ² (AWG)]		
OU	Outdoor unit	208V	230V	208V	230V	208V
IU	Indoor unit	208V	230V	208V	230V	230V
SC	System controller					208V
MA R/C	MA remote controller					230V
ME R/C	ME remote controller					230V
				460V		460V
	PURY-EP72YNU	2.1 (14)		2.1 (14)		15A 30mA or 100mA 0.1sec. or less
	PURY-EP96YNU	3.3 (12)		3.3 (12)		20A 30mA or 100mA 0.1sec. or less
	PURY-EP120YNU	5.3 (10)		5.3 (10)		30A 30mA or 100mA 0.1sec. or less
	PURY-EP144YNU	8.4 (8)		8.4 (8)		35A 30mA or 100mA 0.1sec. or less
	PURY-EP168YNU	8.4 (8)		8.4 (8)		40A 100mA 0.1sec. or less
	PURY-EP192YNU	8.4 (8)		8.4 (8)		40A 100mA 0.1sec. or less
	PURY-EP216YNU	13.3 (6)		13.3 (6)		50A 100mA 0.1sec. or less
	PURY-EP240YNU	13.3 (6)		13.3 (6)		50A 100mA 0.1sec. or less

The local standards and/or regulations is applicable at a higher priority.
 10-4-2. PURY-EP192, 216, 240, 264, 288, 312, 336, 384, 432TSNU/YSNU

<In the case a system controller is connected.>

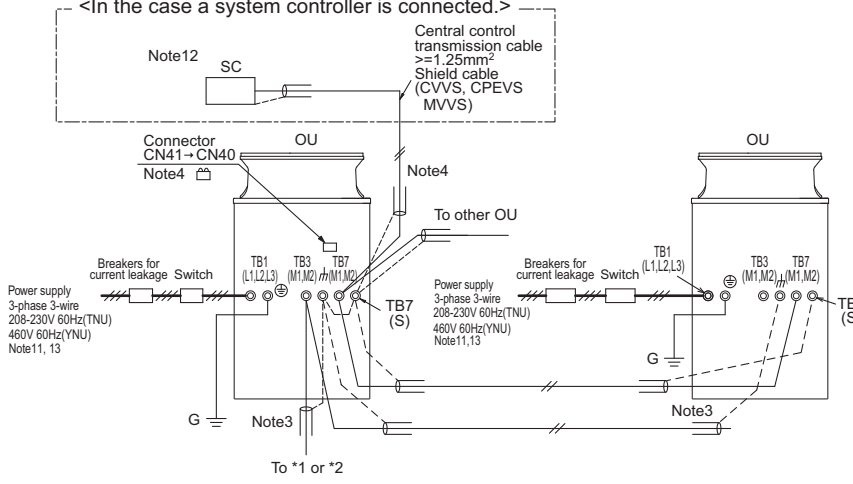

- Note:
- The transmission cable is not-polarity double-wire.
 - Symbol ⊙ means a screw terminal for wiring.
 - The shield wire of transmission cable should be connected to the grounding terminal at Outdoor unit. All shield wire of M-Net transmission cable among Indoor units should be connected to the S terminal at Indoor unit or all shield wire should be connected together.
The broken line at the scheme means shield wire.
 - The connector change from CN41 to CN40 at one of the outdoor units will enable the outdoor unit to supply power to TB7. The transmission cable (above 1.25mm², shielded, CVVS/CPEVS/MVVS) among Outdoor units and system controllers is called central control transmission cable. The shield wire of the central control transmission cable must be grounded at the Outdoor unit whose CN41 is changed to CN40. When the power supply unit PAC-SC51KUA is used, connect the shielded cable to the ground terminal on the PAC-SC51KUA.
 - MA R/C transmission cable (0.3-1.25mm²) must be less than 200m in length, while ME R/C transmission cable (0.3-1.25mm²) must be less than 10m in length. But transmission cable to the ME R/C can be extend using a M-NET cable (≥1.25mm²) when the length is counted in the M-Net length.
 - To wire PAR-CT01MAU, PAR-40MAAU, and PAC-YT53CRAU, use a wire with a diameter of 0.3mm² [AWG 22].
 - MA remote controller and ME remote controller should not be grouped together. When a PAR-CT01MAU or PAR-40MAAU is connected to a group, no other MA remote controllers can be connected to the same group.
 - If using 1 or 2 (main/sub) MA remote controller to control more than 1 Indoor unit, use MA transmission cable to connect all the TB15 terminals of the Indoor units. It is called "Grouping".
If using 1 or 2 (main/sub) ME remote controller control more than 1 indoor unit, set address to Indoor unit and ME remote controller. For the method, refer to 11-4. "Address setting".
 - Indoor board consumes power from TB3. The power balance should be considered according to System Design 11-3. "System configuration restrictions".
 - If Transmission booster is needed, be sure to connect the shield wires to the both sides to the booster.
 - The critical current for choosing power source equipment is approximate 1.4 times of total rated current of the Outdoor unit(s) or Indoor unit(s).
 - When System controller (SC) is connected to the system, turn the SW5-1 on.
 - The phases of electricity power must be confirmed to be right used. Phase-reverse, or phase-missing could break the controllers.

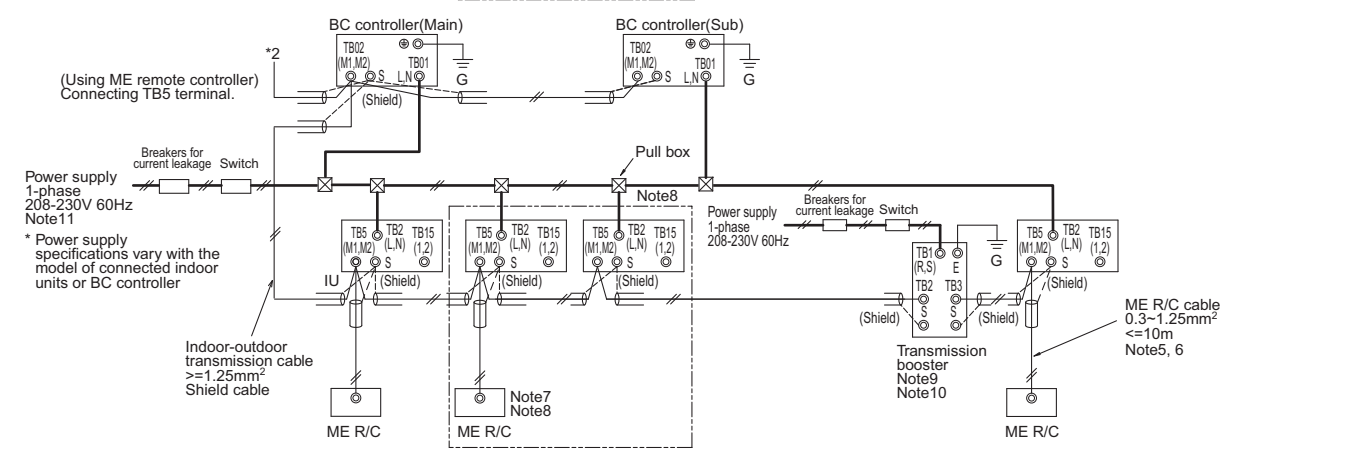
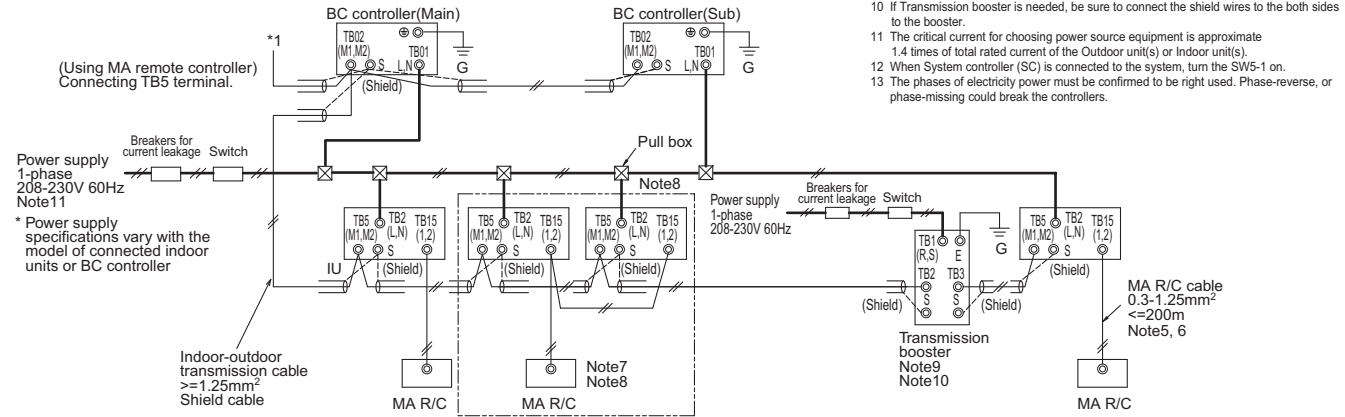

Symbol	Model	Minimum Wire thickness				Breaker for current leakage
		Power wire [mm ² (AWG)]		G wire [mm ² (AWG)]		
OU	Outdoor unit	208V	230V	208V	230V	208V
		8.4 (8)	5.3 (10)	8.4 (8)	5.3 (10)	35A 30mA or 100mA 0.1sec. or less
IU	Indoor unit	208V	230V	208V	230V	230V
		13.3 (6)	13.3 (6)	13.3 (6)	13.3 (6)	30A 30mA or 100mA 0.1sec. or less
SC	System controller	208V	230V	208V	230V	45A 100mA 0.1sec. or less
		21.2 (4)	21.2 (4)	21.2 (4)	21.2 (4)	60A 100mA 0.1sec. or less
MA R/C	MA remote controller	208V	230V	208V	230V	60A 100mA 0.1sec. or less
		21.2 (4)	21.2 (4)	21.2 (4)	21.2 (4)	70A 100mA 0.1sec. or less
ME R/C	ME remote controller	208V	230V	208V	230V	80A 100mA 0.1sec. or less
		33.6 (2)	33.6 (2)	33.6 (2)	33.6 (2)	90A 100mA 0.1sec. or less
		460V			460V	
		2.1 (14)	3.3 (12)	2.1 (14)	3.3 (12)	15A 30mA or 100mA 0.1sec. or less
		5.3 (10)	5.3 (10)	5.3 (10)	5.3 (10)	20A 30mA or 100mA 0.1sec. or less
		8.4 (8)	8.4 (8)	8.4 (8)	8.4 (8)	30A 30mA or 100mA 0.1sec. or less
		8.4 (8)	8.4 (8)	8.4 (8)	8.4 (8)	35A 30mA or 100mA 0.1sec. or less
		8.4 (8)	8.4 (8)	8.4 (8)	8.4 (8)	40A 100mA 0.1sec. or less
		8.4 (8)	8.4 (8)	8.4 (8)	8.4 (8)	40A 100mA 0.1sec. or less
		13.3 (6)	13.3 (6)	13.3 (6)	13.3 (6)	50A 100mA 0.1sec. or less
		13.3 (6)	13.3 (6)	13.3 (6)	13.3 (6)	50A 100mA 0.1sec. or less

11-1. Transmission cable length limitation

11-1-1. Using MA Remote controller

MA remote controller refers to Simple MA remote controller and wireless remote controller.

Long transmission cable causes voltage down, therefore, the length limitation should be obeyed to secure proper transmission.

Max. length via Outdoor (M-NET cable)	$L1+L2+L3, L1+L2+L4+L5, L3+L4+L5, L6+L2+L3, L6+L2+L4+L5$	$\leq 500\text{m}[1640\text{ft.}]$	1.25mm ² [AWG16] or thicker
Max. length to Outdoor (M-NET cable)	$L1+L6, L3, L2+L4+L6, L5$	$\leq 200\text{m}[656\text{ft.}]$	1.25mm ² [AWG16] or thicker
Max. length from MA to Indoor for each group	$a1+a2, a1+a2+a3+a4$	$\leq 200\text{m}[656\text{ft.}]$	0.3-1.25 mm ² [AWG22-16]
24VDC to AG-150A-A	n	$\leq 50\text{m}[164\text{ft.}]$	0.75-2.0 mm ² [AWG18-14]

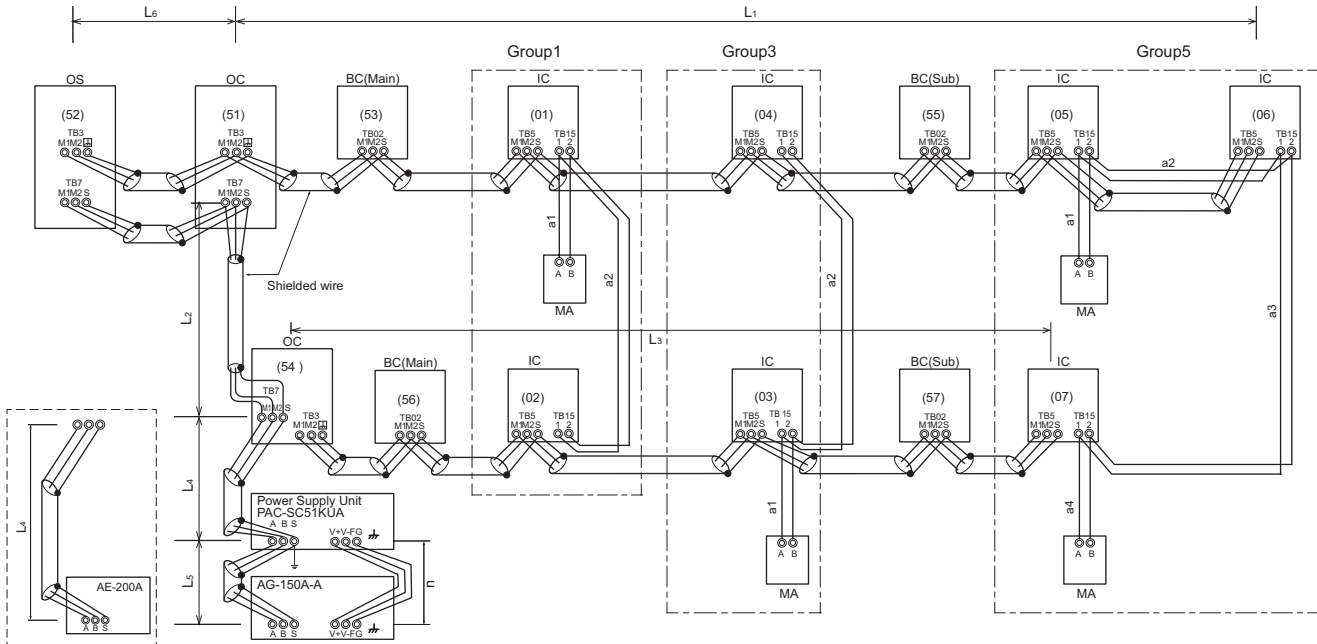

OC, OS : Outdoor unit controller; IC: Indoor unit controller; MA: MA remote controller

11-1-2. Using ME Remote controller

ME remote controller refers to Smart ME Controller.

Long transmission cable causes voltage down, therefore, the length limitation should be obeyed to secure proper transmission.

Max. length via Outdoor (M-NET cable)	$L1+L2+L3+L4, L1+L2+L5+L6, L3+L4+L5+L6$	$\leq 500\text{m}[1640\text{ft.}]$	1.25mm ² [AWG16] or thicker
	$L7+L2+L3+L4, L7+L2+L5+L6, L3+L5+L6$		
Max. length to Outdoor (M-NET cable)	$L1+L7, L3+L4, L2+L5+L7, L6$	$\leq 200\text{m}[656\text{ft.}]$	1.25mm ² [AWG16] or thicker
Max. length from ME to Indoor	$e1, e2, e3, e4$	$\leq 10\text{m}[32\text{ft.}]^*1$	0.3-1.25 mm ² [AWG22-16] *1
24VDC to AG-150A-A	n	$\leq 50\text{m}[164\text{ft.}]$	0.75-2.0 mm ² [AWG18-14]

*1. If the length from ME to Indoor exceed 10m, use 1.25 mm² [AWG16] shielded cable, but the total length should be counted into Max. length via Outdoor.

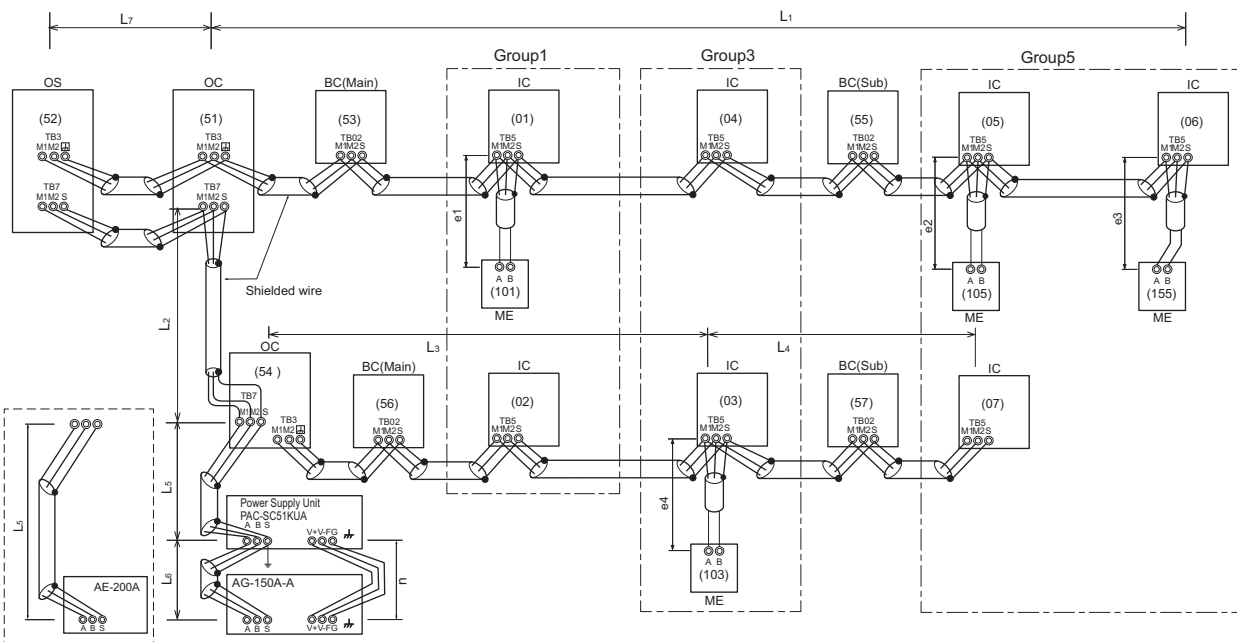

OC, OS : Outdoor unit controller; IC: Indoor unit controller; ME: ME remote controller

PURV-EP-T(S)NU-A, Y(S)NU-A

11-2. Transmission cable specifications

	Transmission cables (Li)	MA Remote controller cables	ME Remote controller cables
Type of cable	Shielded cables (2-core) CVVS, CPEVS, and MVVS	VCTF, VCTFK, CVV, VVR, VVF, VCT	Shielded cables (2-core) CVVS, CPEVS, and MVVS
Cable size	Larger than 1.25 mm ² [AWG16], or ø1.2 mm or above	0.3 to 1.25 mm ² [AWG22 to 16] *1 *5	0.3 to 1.25 mm ² [AWG22 to 16] *1 *6
Maximum overall line length	Refer to 11-1.	200 m [656 ft] *3 *4	10 m [32 ft] *2

*1 The use of cables that are smaller than 0.75 mm² (AWG18) is recommended for easy handling.

*2 The section of the cable that exceeds 10 m [32 ft] must be included in the maximum indoor-outdoor transmission line distance.

*3 Max. 70 m [229 ft] for PAR-CT01MA series

*4 Max. 150 m [492 ft] for PAR-FS01MA series

*5 To wire PAR-CT01MA series, PAR-FS01MA series, PAR-4"x"MA series, PAR-3"x"MA series ("x" represents 0 or later), or Simple MA remote controller, use a cable with a size of 0.3 mm² (AWG 22).

*6 When connected to the terminal block on the Simple remote controller, use a cable with a size of 0.75 to 1.25 mm² (AWG18 to 16).

CVVS, MVVS: PVC insulated PVC sheathed shielded control cable
CPEVS: PE insulated PVC sheathed shielded communication cable
CVV: PVC insulated PVC sheathed control cable

11-3. System configuration restrictions

11-3-1. Common restrictions for the CITY MULTI system

For each Outdoor/Heat source unit, the maximum connectable quantity of Indoor unit is specified at its Specifications table.

- A) 1 Group of Indoor units can have 1-16 Indoor units;
- B) Maximum 2 remote controllers for 1 group;
 - *MA/ME remote controllers cannot be present together in 1group.
 - *When the PAR-CT01MA series, PAR-FS01MA series, PAR-4"x"MA series, or PAR-3"x"MA series ("x" represents 0 or later) is connected to a group, no other MA remote controllers can be connected to the same group.
- C) 1 LOSSNAY unit can interlock maximum 16 Indoor units; 1 Indoor unit can interlock only 1 LOSSNAY unit.
- D) Maximum 3 System controllers are connectable when connecting to TB3 of the Outdoor/Heat source unit.
- E) A maximum of 6 system controller are connectable to TB3 and TB7 of Outdoor/Heat source unit.
- F) 4 System controllers or more are connectable when connecting to TB7 of the Outdoor/Heat source unit, if the transmission power is supplied by the power supply unit PAC-SC51KUA.
 - *System controller connected as described in D) would have a risk that the failure of connected Outdoor/Heat source unit would stop power supply to the System controller.

11-3-2. Ensuring proper communication power and the number of connected units for M-NET

In order to ensure proper communication among Outdoor/Heat source unit, Indoor unit, LOSSNAY, and Controllers, the transmission power situation for the M-NET should be observed. In some cases, Transmission booster should be used. Taking the power consumption of Indoor unit as 1, the equivalent power consumption or supply of others are listed at Table 1 and Table 2.

Both the transmission line for centralized controller and indoor-outdoor transmission line must meet the conditions listed below. (Both conditions a) and b) must be met.)

- a) [Total equivalent power consumption] ≤ [The equivalent power supply]
- b) [Total equivalent number of units (Table1)] ≤ [40]

Table 1 The equivalent power consumption and the equivalent number of units

Category	Model	The equivalent power consumption	The equivalent number of units
Indoor unit	Sized P04-P96, PEFY-AF1200CFM-E	1	1
	PEFY-AF1200CFMR-E	2	2
BC controller	CMB	2	1
PWFY *1	P36NMU-E-BU	6	1
	P36NMU-E2-AU	1	1
	P72NMU-E2-AU	5	1
MA remote controller/LOSSNAY	PAR-CT01MAU PAR-41MAAU PAC-YT53CRAU PAR-FA32MA LGH-F-RX ₅ -E1 LGH-F-RVX-E PZ-60DR-E PZ-61DR-E PZ-43SMF-E	0	0
ME remote controller	PAR-U01MEDU	0.5	1
System controller	AE-200A AE-50A EW-50A LM-AP	0	0
	AG-150A-A EB-50GU-A PAC-IF01AHC-J	0.5	1
	TC-24B	1.5	5
	PAC-YG60MCA PAC-YG66DCA PAC-YG63MCA	0.25	1
ON/OFF controller	PAC-YT40ANRA	1	1
MN converter	CMS-MNG-E	2	1
Outdoor/Heat source unit	TB7 power consumption	0	0
System control interface	MAC-333IF-E	0	0
A-M converter	PAC-IF01MNT-E	1	2

*1 PWFY cannot be connected to PUMY model.

Table 2 The equivalent power supply

Category	Model	The equivalent power supply		
Transmission Booster	PAC-SF46EPA-G	25 *1		
Power supply unit	PAC-SC51KUA	5		
Expansion controller	PAC-YG50ECA	6		
BM ADAPTER	BAC-HD150	6		
System controller	AE-200A/AE-50A	0.75		
	EW-50A	1.5		
	LM-AP	0		
Outdoor/Heat source unit		TB3 and TB7 total	TB7 only	TB3 only
	Outdoor unit other than the following units *2	32 *1	6	32*1 - equivalent power supplied to TB7
	S-Series outdoor unit	12 *1	0	12 *1
	TLMU/TKMU outdoor unit	32 *1	- *3	32 *1

*1 When one or more indoor units listed below is connected, subtract 3 from the equivalent power supply.

Table 3

Category	Model
Indoor unit	Sized P72, P96 PEFY-AF1200CFM(R)-E

*2 If PAC-SC51KUA is used to supply power at TB7 side, no power supply need from Outdoor/Heat source unit at TB7, Connector TB3 itself will therefore have 32.

With the equivalent power consumption values and the equivalent number of units in Table 1 and Table 2, PAC-SF46EPA-G can be designed into the air-conditioner system to ensure proper system communication according to (A), (B), (C).

- (A) Firstly, count from TB3 at TB3 side the total equivalent number of units of Indoor units, ME remote controller, and System controllers. If the total equivalent number of units reaches 40, a PAC-SF46EPA-G should be set.
- (B) Secondly, count from TB7 side to TB3 side the total transmission power consumption. If the total equivalent power supply reaches 32, a PAC-SF46EPA-G should be set. Yet, if a PAC-SC51KUA or another controller with a built-in power supply, such as PAC-YG50ECA, is used to supply power at TB7 side, count from TB3 side only.
- (C) Thirdly, count from TB7 at TB7 side the total transmission power consumption, If the total equivalent power supply for only TB7 reaches 6, a PAC-SF46EPA-G should be set. Also, count from TB7 at TB7 side the total equivalent number of units of System controllers, and so on. If the total equivalent number of units reaches 40, a PAC-SF46EPA-G should be set.

* The equivalent power supply of S-Series outdoor unit is 12.

* When one or more indoor units listed in Table 3 is connected, subtract 3 from the equivalent power supply.

■ System example

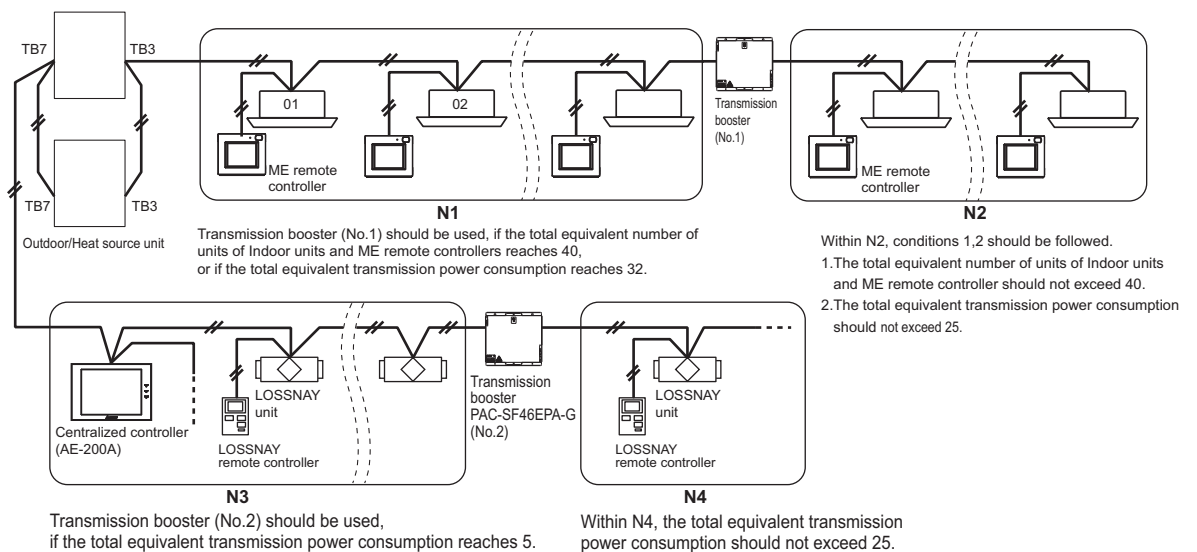

11-3-3. Ensuring proper power supply to System controller

The power to System controller (excluding AE-200A, AE-50A, EW-50A, BAC-HD150) is supplied via M-NET transmission line. M-NET transmission line at TB7 side is called Centralized control transmission line while one at TB3 side is called Indoor-Outdoor/Heat source transmission line. There are 3 ways to supply power to the System controller.

- A) Connecting to TB3 of the Outdoor/Heat source unit and receiving power from the Outdoor/Heat source unit.
- B) Connecting to TB7 of the Outdoor/Heat source unit and receiving power from the Outdoor/Heat source unit.
(Not applicable to the PUMY model)
- C) Connecting to TB7 of the Outdoor/Heat source unit but receiving power from power supply unit PAC-SC51KUA.

* System controllers (AE-200A, AE-50A, EW-50A, BAC-HD150) have a built-in function to supply power to the M-NET transmission lines, so no power needs to be supplied to the M-NET transmission lines from the Outdoor/Heat source units or from PAC-SC51KUA.

11-3-3-A. When connecting to TB3 of the Outdoor/Heat source unit and receiving power from the Outdoor/Heat source unit.

Maximum 3 System controllers can be connected to TB3.
If there is more than 1 Outdoor/Heat source unit, it is necessary to replace power supply switch connector CN41 with CN40 on one Outdoor/Heat source unit.

Fig. 11-3-3-A

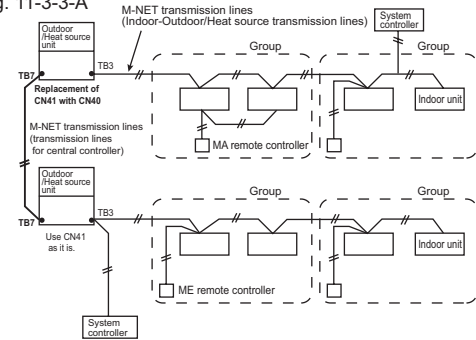

11-3-3-B. When connecting to TB7 of the Outdoor/Heat source unit and receiving power from the Outdoor/Heat source unit. (Not applicable to the PUMY model)

A maximum of 6 system controller are connectable to TB3 and TB7 of Outdoor/Heat source unit.
(Not applicable to the PUMY model)
It is necessary to replace power supply switch connector CN41 with CN40 on one Outdoor/Heat source unit.

Fig. 11-3-3-B

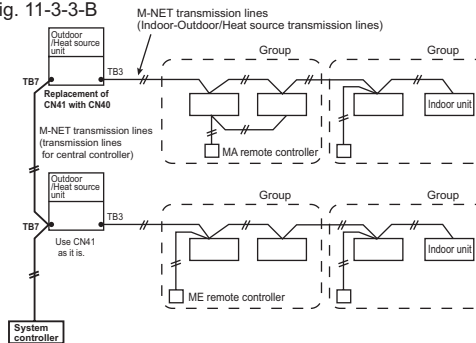

11-3-3-C. When connecting to TB7 of the Outdoor/Heat source unit but receiving power from PAC-SC51KUA.

When using PAC-SC51KUA to supply transmission power, the power supply connector CN41 on the Outdoor/Heat source units should be kept as it is. It is also a factory setting.
1 PAC-SC51KUA supports maximum 1 AG-150A-A or 1 EB-50GU-A unit due to the limited power 24VDC at its TB3.
However, 1 PAC-SC51KUA supplies transmission power at its TB2 equal to 5 Indoor units, which is referable at Table 2.
If System controller, ON/OFF controller connected to TB7 consume transmission power more than 5 (Indoor units), Transmission booster PAC-SF46EPA-G is needed. PAC-SF46EPA-G supplies transmission power equal to 25 Indoor units.

Fig. 11-3-3-C

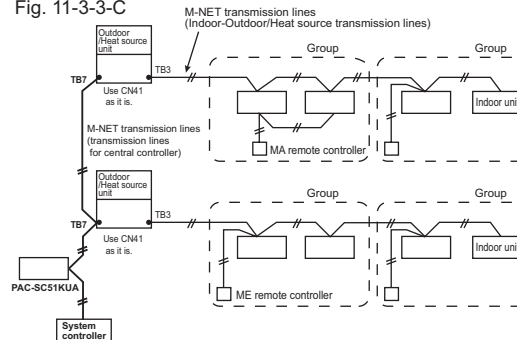

CAUTION

- How to connect system controllers (AE-200A, AE-50A, EW-50A, BAC-HD150) to a given system System controllers (AE-200A, AE-50A, EW-50A, BAC-HD150) have a built-in function to supply power to the M-NET transmission lines, so no power needs to be supplied to the M-NET transmission lines from the Outdoor/Heat source units or from PAC-SC51KUA.
Leave the power supply connector on the Outdoor/Heat source unit connected to CN41 as it is. Refer to 11-3-2 for information about the power-supply capacity of each system controller (EW-50A, BAC-HD150) to the low-level system controllers.

Fig. 11-3-3-D

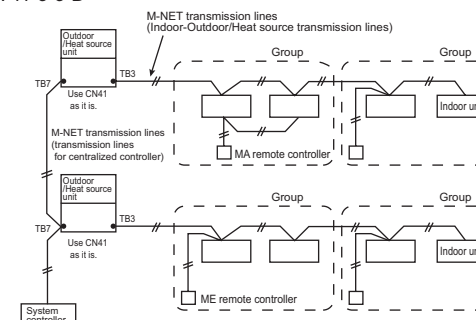

11-3-4. Power supply to expansion controller

1-phase 100-240VAC power supply is needed.

The power supply unit PAC-SC51KUA is not necessary.

The expansion controller supplies power through TB3, which equals 6 indoor units. (refer to Table 2)

11-3-5. Power supply to BM ADAPTER

1-phase 100-240VAC power supply is needed.

The power supply unit PAC-SC51KUA is not necessary when only BM ADAPTER is connected.

Yet, make sure to move the power jumper from CN41 to CN40 on the BM ADAPTER.

11-3-6. Power supply to AE-200A/AE-50A/EW-50A

1-phase 100-240VAC power supply is needed.

The power supply unit PAC-SC51KUA is not necessary when connecting only the AE-200A/AE-50A/EW-50A.

PURY-EP-T(S)NU-A, Y(S)NU-A

11-4. Address setting

11-4-1. Switch operation

In order to constitute CITY MULTI in a complete system, switch operation for setting the unit address No. and connection No. is required.

- ① Address No. of outdoor unit, indoor unit and ME remote controller.
The address No. is set at the address setting board.
In the case of R2 system, it is necessary to set the same No. at the branch No. switch of indoor unit as that of the BC controller connected. (When connecting two or more branches, use the lowest branch No.)

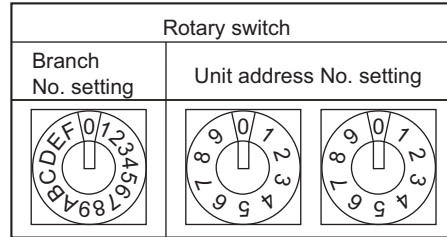

- ② Caution for switch operations

- Be sure to shut off power source before switch setting. If operated with power source on, switch can not operate properly.
- No units with identical unit address shall exist in one whole air conditioner system. If set erroneously, the system can not operate.

- ③ MA remote controller

- When connecting only one remote controller to one group, it is always the main remote controller.
When connecting two remote controllers to one group, set one remote controller as the main remote controller and the other as the sub remote controller.
- The factory setting is "Main".

PAR-4"x"MAA ("x" represents 0 or later), PAR-CT01MA
The MA remote controller does not have the switches listed above.
Refer to the installation manual for the function setting.

PAC-YT53CRAU

Setting the dip switches

There are switches on the back of the top case. Remote controller Main/Sub and other function settings are performed using these switches. Ordinarily, only change the Main/Sub setting of SW1.
(The factory settings are ON for SW1, 3, and 4 and OFF for SW2.)

SW No	SW contents Main	ON	OFF	Comment
1	Remote controller Main/Sub setting	Main	Sub	Set one of the two remote controllers at one group to "ON".
2	Temperature display units setting	Celsius	Fahrenheit	When the temperature is displayed in [Fahrenheit], set to "OFF".
3	Cooling/heating display in AUTO mode	Yes	No	When you do not want to display "Cooling" and "Heating" in the AUTO mode, set to "OFF".
4	Indoor temperature display	Yes	No	When you do not want to display the indoor temperature, set to "OFF".

11-4-2. Rule of setting address

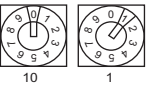
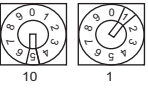
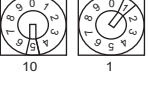
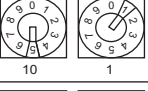
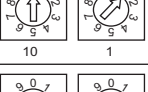
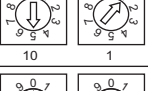
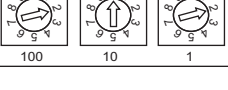
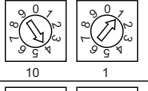
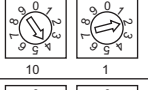
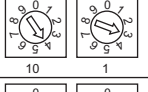
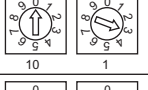
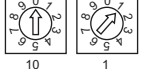
Unit	Address setting	Example	Note
Indoor unit System control interface (MAC-333IF-E) A-M converter (PAC-IF01MNT-E)	01 ~ 50		Use the most recent address within the same group of indoor units. Make the indoor units address connected to the BC controller (Sub) larger than the indoor units address connected to the BC controller (Main). If applicable, set the sub BC controllers in an PURY system in the following order: (1) Indoor unit to be connected to the BC controller (Main) (2) Indoor unit to be connected to the BC controller (No.1 Sub) (3) Indoor unit to be connected to the BC controller (No.2 Sub) Set the address so that (1)<(2)<(3)
Outdoor unit	51 ~ 99, 100 (Note1)		The smallest address of indoor unit in same refrigerant system + 50 Assign sequential address numbers to the outdoor units in one refrigerant circuit system. OC and OS are automatically detected. (Note 2) *Please reset one of them to an address between 51 and 99 when two addresses overlap. *The address automatically becomes "100" if it is set as "01~ 50"
BC controller (Main)	52 ~ 99, 100		The address of outdoor unit + 1 *Please reset one of them to an address between 51 and 99 when two addresses overlap. *The address automatically becomes "100" if it is set as "01~ 50"
BC controller (Sub)	52 ~ 99, 100		Lowest address within the indoor units connected to the BC controller (Sub) plus 50.
Local remote controller	ME, LOSSNAY Remote controller (Main)	1 Fixed 	The smallest address of indoor unit in the group + 100 *The place of "100" is fixed to "1"
	ME, LOSSNAY Remote controller (Sub)	1 Fixed 	The address of main remote controller + 50 *The address automatically becomes "200" if it is set as "00"
System controller	ON/OFF remote controller		The smallest group No. to be managed + 200 * The smallest group No. to be managed is changeable.
	AE-200A/AE-50A AG-150A-A EB-50GU-A EW-50A TC-24B	0, 2 0-5 0-9 100 10 1	* TC-24B cannot be set to "000".
	PAC-YG50ECA	0, 2 0-5 0-9 100 10 1	* Settings are made on the initial screen of AG-150A-A.
	BAC-HD150	0, 2 0-5 0-9 100 10 1	* Settings are made with setting tool of BM ADAPTER.
PI, AI, DIDO	PAC-YG60MCA		
	PAC-YG63MCA		
	PAC-YG66DCA		
LOSSNAY	01 ~ 50		After setting the addresses of all the indoor units, assign an arbitrary address.
PAC-IF01AHC-J	201 ~ 250	2 Fixed 	

Note1: To set the address to "100", set it to "50"

Note2: Outdoor units OC and OS in one refrigerant circuit system are automatically detected.

OC and OS are ranked in descending order of capacity. If units are the same capacity, they are ranked in ascending order of their address.

11-4-3. System examples

Factory setting

Original switch setting of the outdoors, indoors, controllers, and BM ADAPTER at shipment is as follows.

- Outdoor unit : Address: 00, CN41: ON (Jumper), DipSW5-1: OFF
- Indoor unit : Address: 00
- BC controller : Address: 00
- ME remote controller : Address: 101
- BM ADAPTER : Address: 000, CN41: ON (Jumper)

Setting at the site

- DipSW5-1(Outdoor) : When the System Controller is used, all the Dip SW5-1 at the outdoor units should be set to "ON".
- CN40/CN41 : Change jumper from CN41 to CN 40 at outdoor control board will activate central transmission power supply to TB7;
(Change jumper at only one outdoor unit when activating the transmission power supply without using a power supply unit.)
Power supply unit is recommended to use for a system having more than 1 outdoor unit, because the central transmission power supply from TB7 of one of outdoor units is risking that the outdoor unit failure may let down the whole central control system.

11-4-3-1. MA remote controller, Single-refrigerant-system, No System Controller

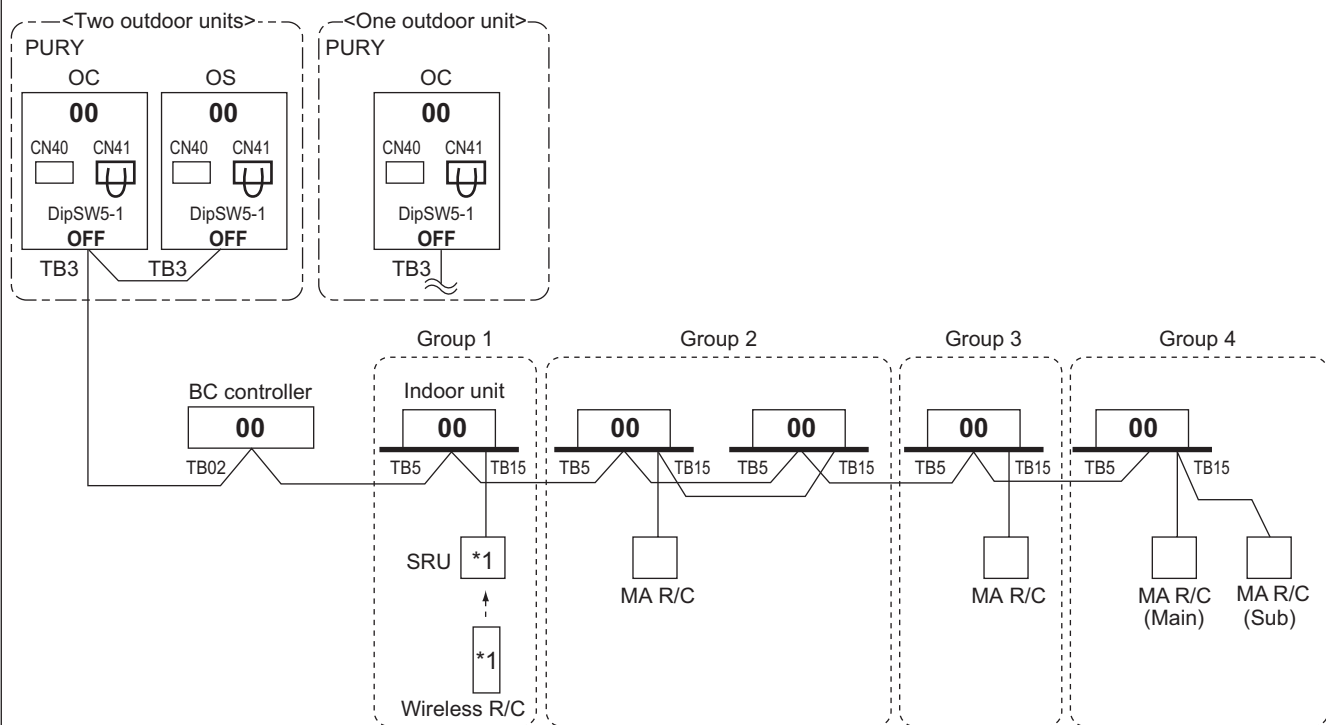

*1 For Wireless R/C and Signal receiver unit (SRU), channel 1, 2 and 3 are selectable and should be set to same channel.

NOTE:

1. Outdoor units OC and OS in one refrigerant circuit system are automatically detected.
OC and OS are ranked in descending order of capacity. If units are the same capacity, they are ranked in ascending order of their address.
2. No address setting is needed.
3. For a system having more than 32 indoor unit, confirm the need of Booster at 11-3. "System configuration restrictions".
4. Indoor units should be set with a branch number.
5. Address setting is required if a sub BC controller is connected.
6. When the PAR-CT01MA series, PAR-FS01MA series, PAR-4"x"MA series, or PAR-3"x"MA series ("x" represents 0 or later) is connected to a group, no other MA remote controllers can be connected to the same group.

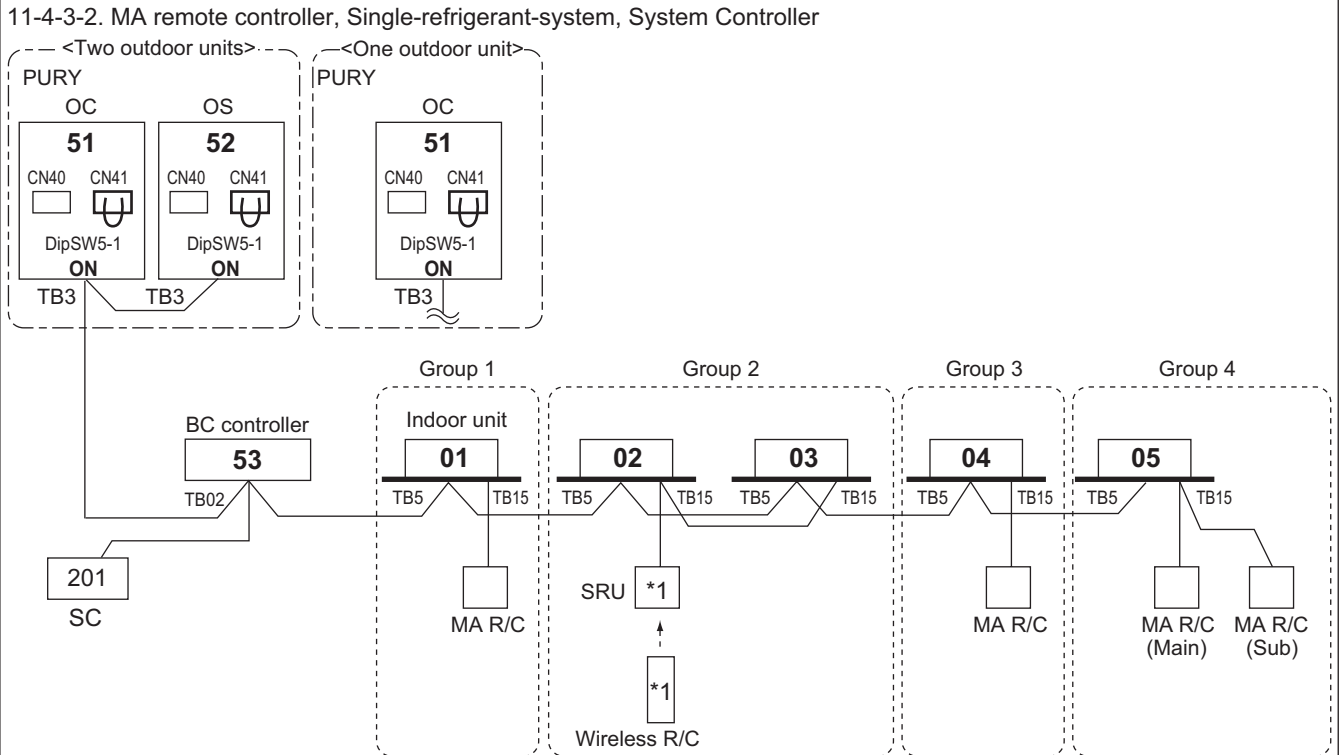

*1 For Wireless R/C and Signal receiver unit (SRU), channel 1, 2 and 3 are selectable and should be set to same channel.

*SC can be connected to TB3 side or TB7 side;

Should SC connected to TB7 side, change Jumper from CN41 to CN40 at the Outdoor unit module so as to supply power to the SC.
Up to three System controllers can be connected to TB3 side.

NOTE:

1. Outdoor units OC and OS in one refrigerant circuit system are automatically detected.
OC and OS are ranked in descending order of capacity. If units are the same capacity, they are ranked in ascending order of their address.
2. Address should be set to Indoor units and central controller.
3. For a system having more than 32 indoor unit, confirm the need of Booster at 11-3. **"System configuration restrictions"**.
4. Indoor units should be set with a branch number.
5. When the PAR-CT01MA series, PAR-FS01MA series, PAR-4"x"MA series, or PAR-3"x"MA series ("x" represents 0 or later) is connected to a group, no other MA remote controllers can be connected to the same group.

PURY-EP-T(S)NU-A, Y(S)NU-A

11-4-3-3. MA remote controller, Multi-refrigerant-system, System Controller at TB7/TB3 side, Booster for long M-NET wiring

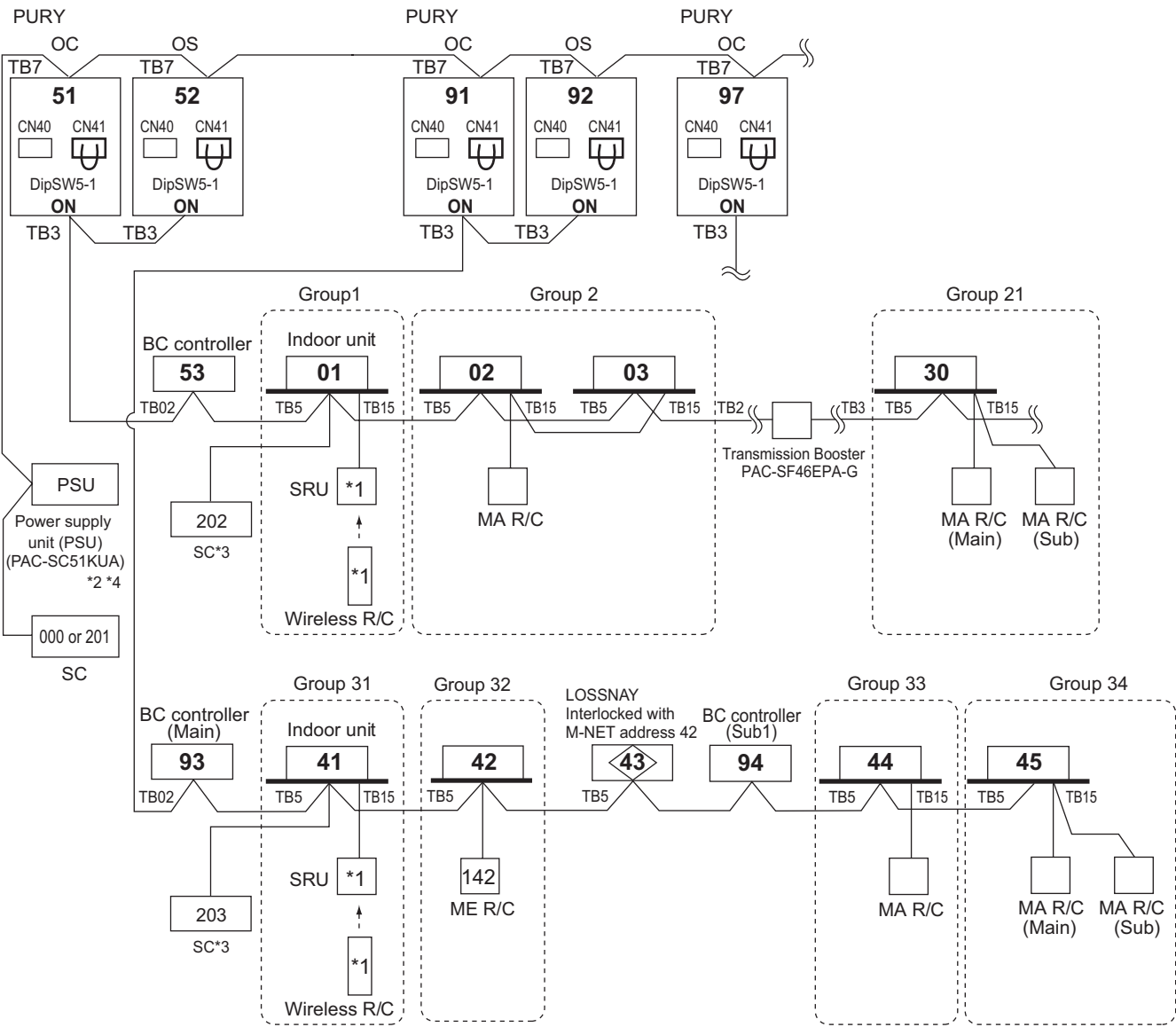

*1 For Wireless R/C and Signal receiver unit (SRU), channel 1, 2 and 3 are selectable and should be set to same channel.
 *2 System controller should connect to TB7 at Outdoor and use power supply unit together in Multi-Refrigerant-System. For AG-150A-A, 24VDC should be used with the PAC-SC51KUA. For AE-200A, AE-50A, and EW-50A the power supply unit PAC-SC51KUA is unused.
 *3 When multiple system controllers are connected in the system, set the controller with more functions than others as a "main" controller and others as "sub". AE-200A, AE-50A, EW-50A, and BAC-HD150 are for exclusive use as a "main" system controller and cannot be used as a "sub" system controller. Make the setting to only one of the system controllers for "prohibition of operation from local remote controller".
 *4 The power supply unit is not necessary for AE-200A, AE-50A, EW-50A, and BAC-HD150.

NOTE:

- Outdoor units OC and OS in one refrigerant circuit system are automatically detected. OC and OS are ranked in descending order of capacity. If units are the same capacity, they are ranked in ascending order of their address.
- Address should be set to Indoor units, LOSSNAY and system controller.
- M-NET power is supplied by the Outdoor unit at TB3, while Indoor unit and ME remote controller consume the M-NET power for transmission use. The power balance is needed to consider for long M-NET wiring. Details refer to 11-3. "System configuration restrictions".
- Indoor units should be set with a branch number.
- Assign an address to each of the sub BC controllers which equals the sum of the smallest address of the indoor units that are connected to each sub BC controller and 50.
- When the PAR-CT01MA series, PAR-FS01MA series, PAR-4"x"MA series, or PAR-3"x"MA series ("x" represents 0 or later) is connected to a group, no other MA remote controllers can be connected to the same group.

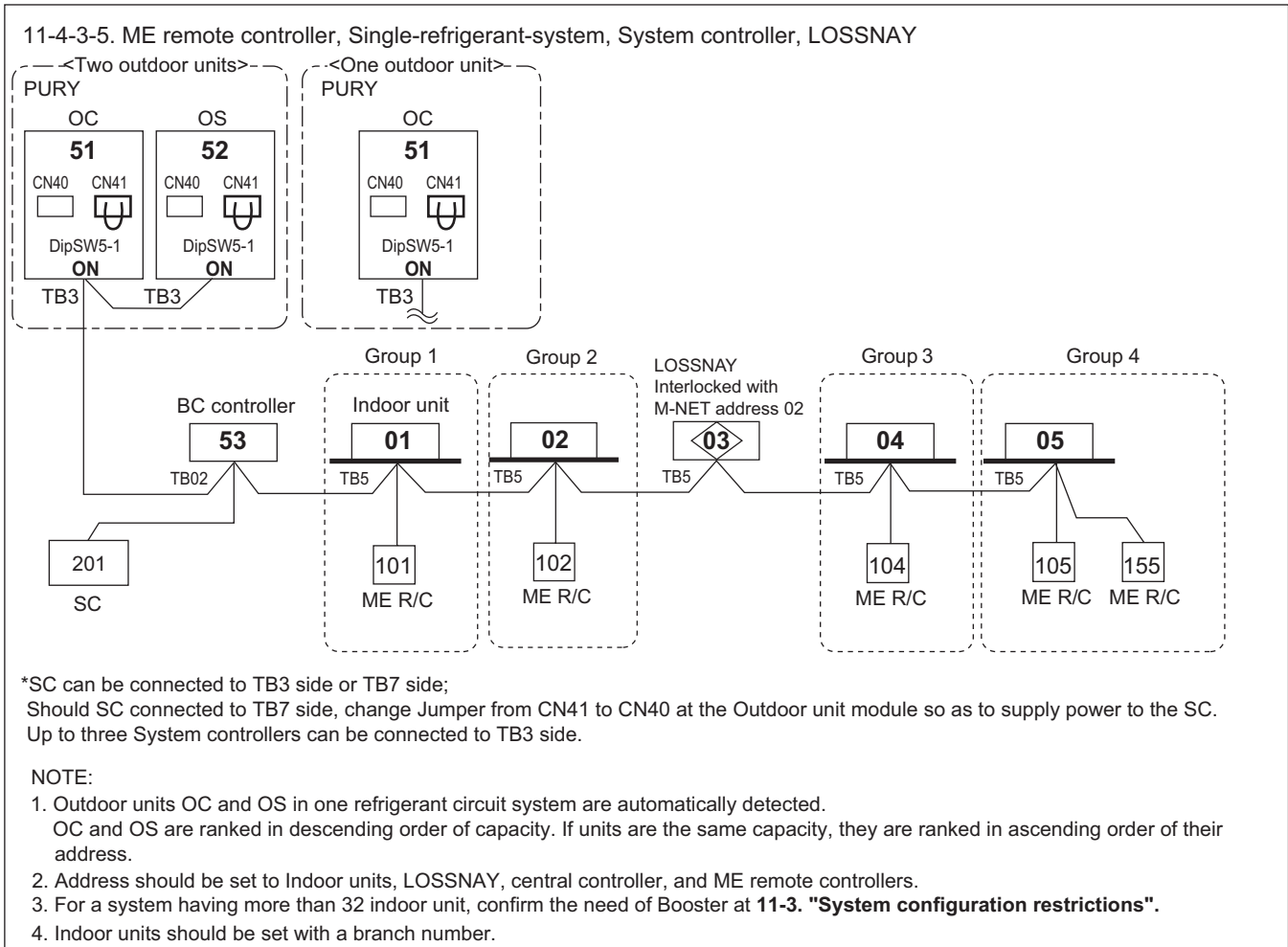
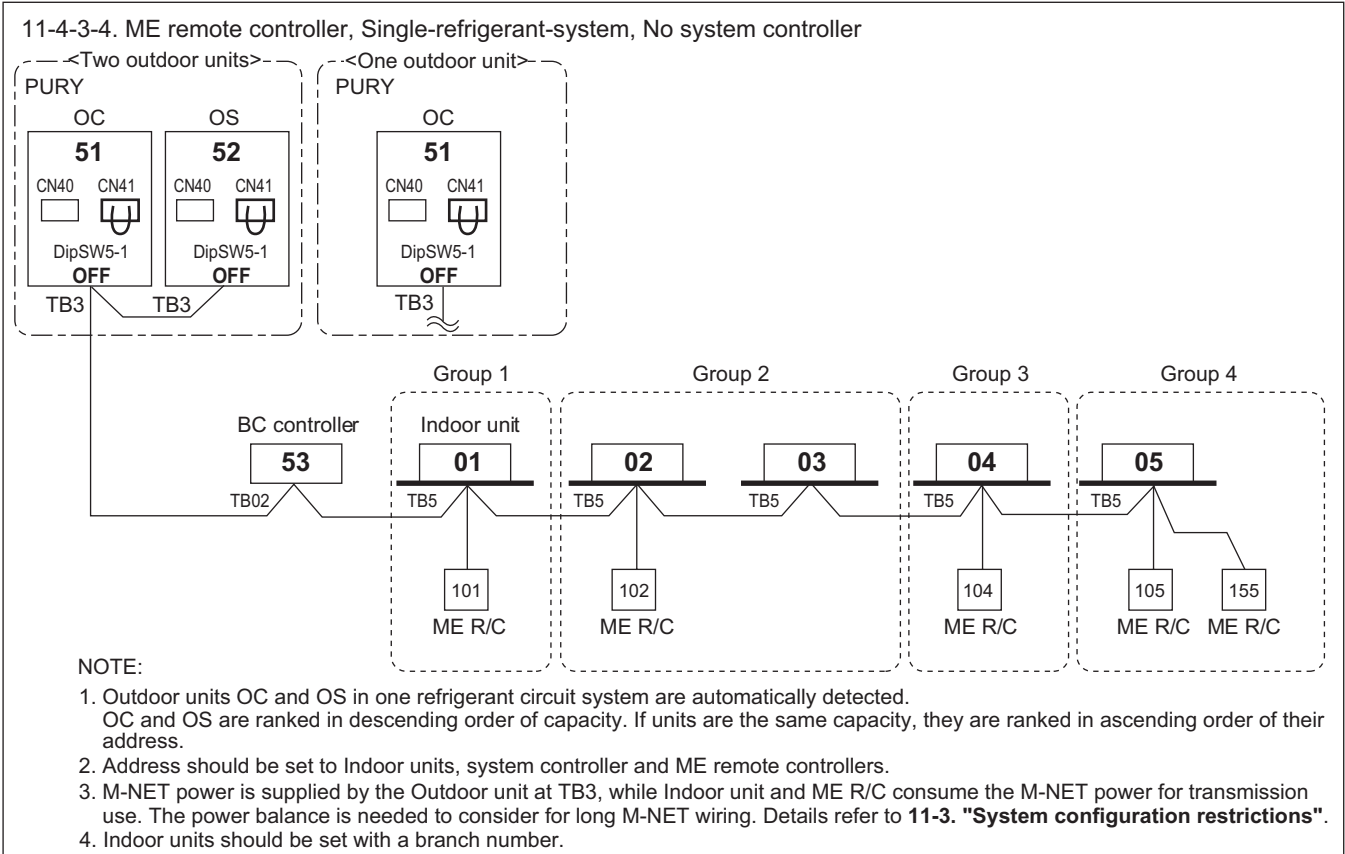

PURY-EP-T(S)NU-A, Y(S)NU-A

11-4-3-6. ME remote controller, Multi-refrigerant-system, System Controller at TB7 side, LOSSNAY, Booster for long M-NET wiring

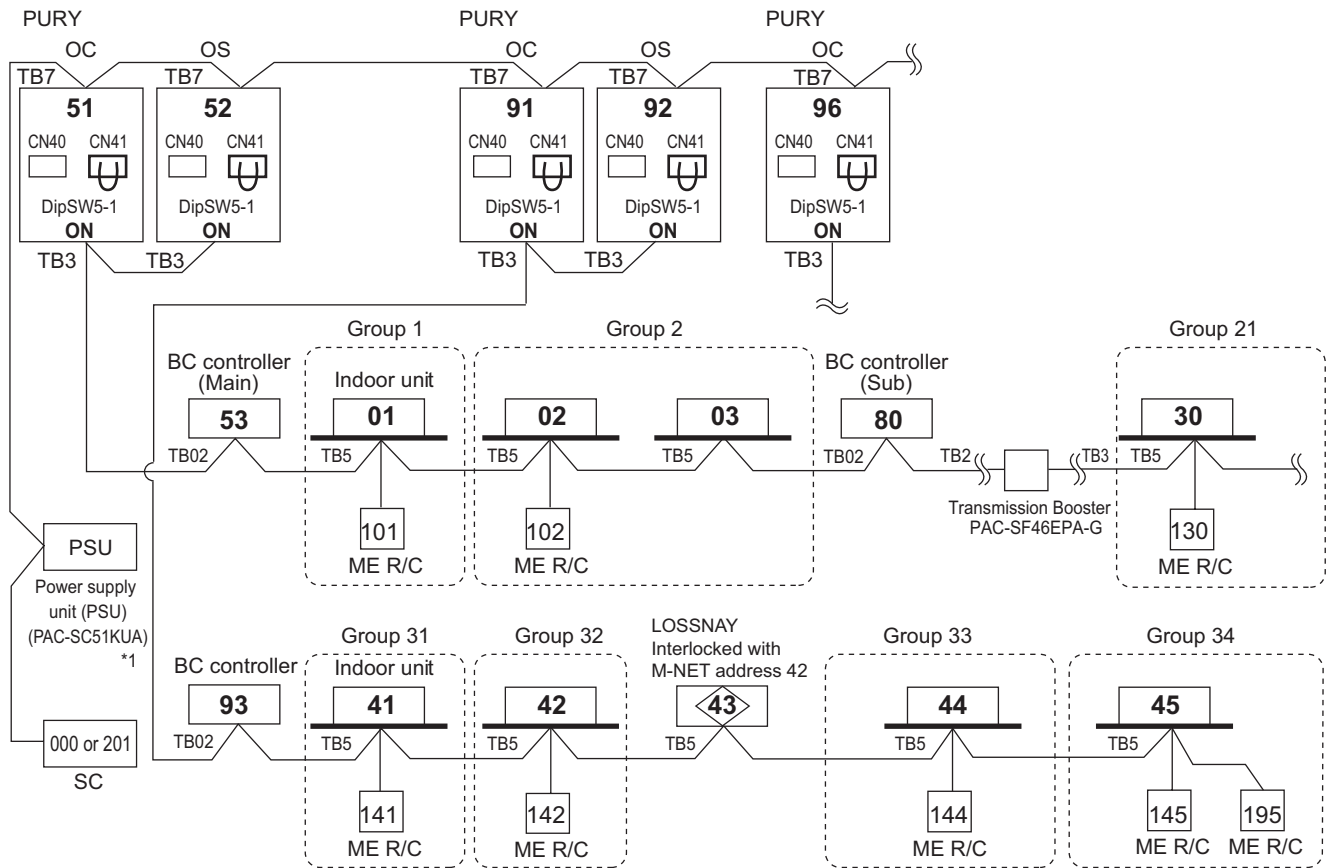

*1 System controller should connect to TB7 at Outdoor and use power supply unit together in Multi-Refrigerant-System. For AG-150A-A, 24VDC should be used with the PAC-SC51KUA. For AE-200A, AE-50A, and EW-50A the power supply unit PAC-SC51KUA is unused.

NOTE:

- Outdoor units OC and OS in one refrigerant circuit system are automatically detected. OC and OS are ranked in descending order of capacity. If units are the same capacity, they are ranked in ascending order of their address.
- M-NET power is supplied by the Outdoor unit at TB3, while Indoor unit and ME R/C consume the M-NET power for transmission use. The power balance is needed to consider for long M-NET wiring. Details refer to 11-3. "System configuration restrictions".
- Indoor units should be set with a branch number.
- Assign an address to each of the sub BC controllers which equals the sum of the smallest address of the indoor units that are connected to each sub BC controller and 50. When the address assigned to sub BC controller overlaps those of any other units including outdoor units (OC/OS) or main BC controller, sub BC controller will be given priority to have the address.

11-4-3-7. Example: BC, BC sub

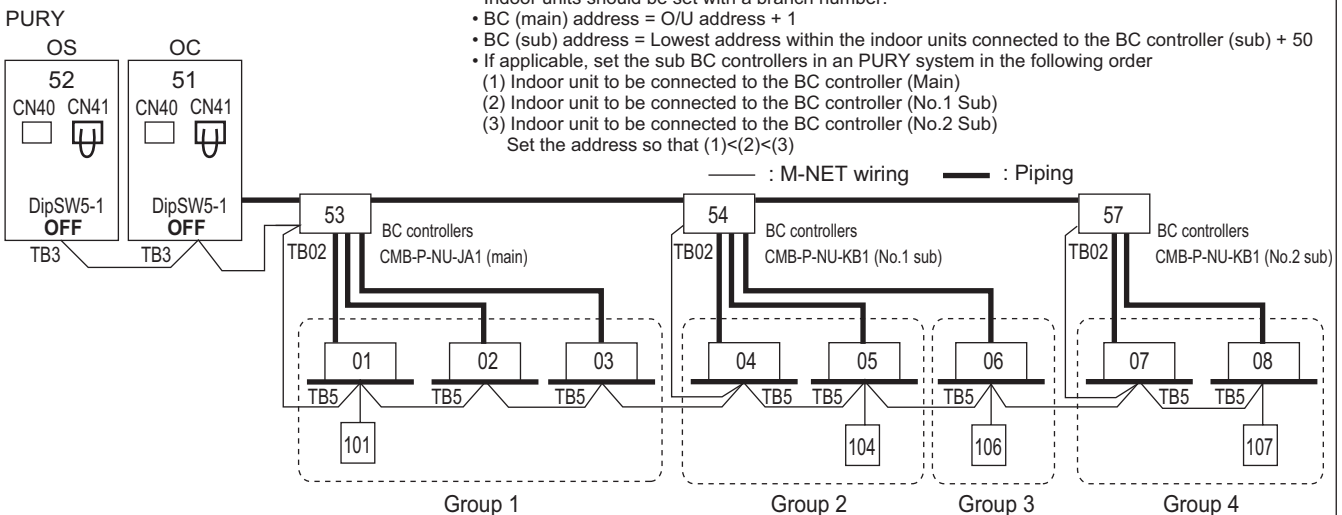

NOTE

- Indoor units should be set with a branch number.
- BC (main) address = O/U address + 1
- BC (sub) address = Lowest address within the indoor units connected to the BC controller (sub) + 50
- If applicable, set the sub BC controllers in an PURY system in the following order
 - Indoor unit to be connected to the BC controller (Main)
 - Indoor unit to be connected to the BC controller (No.1 Sub)
 - Indoor unit to be connected to the BC controller (No.2 Sub)
 Set the address so that (1)<(2)<(3)

11-4-3-8. ME remote controller, Multi-refrigerant-system, No Power supply unit

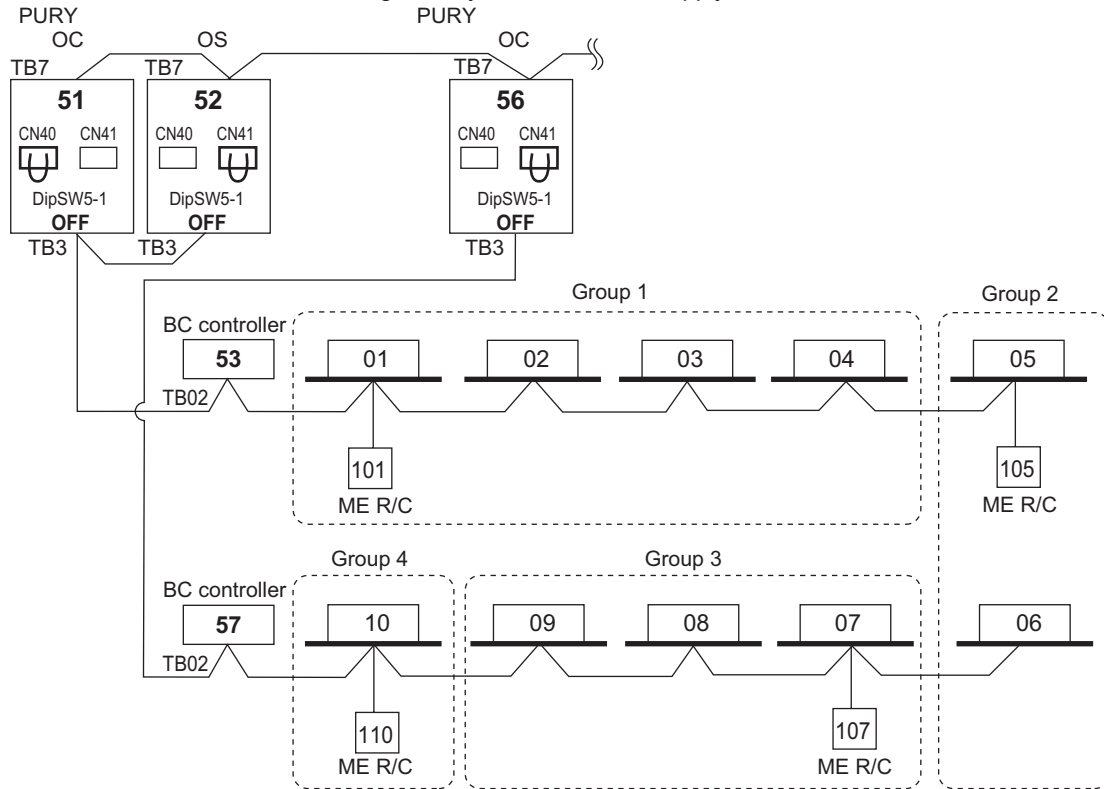

NOTE

- It is necessary to change the connector to CN40 on the outdoor unit control board (only one outdoor unit) when the group is set between other refrigerant systems.
- It is necessary to set on the remote controller by manual when group sets on the different refrigerant system. Please refer to remote controller installation manual.

11-4-3-9. ME remote controller, Multi-refrigerant-system, System Controller at TB7 side, No Power supply unit

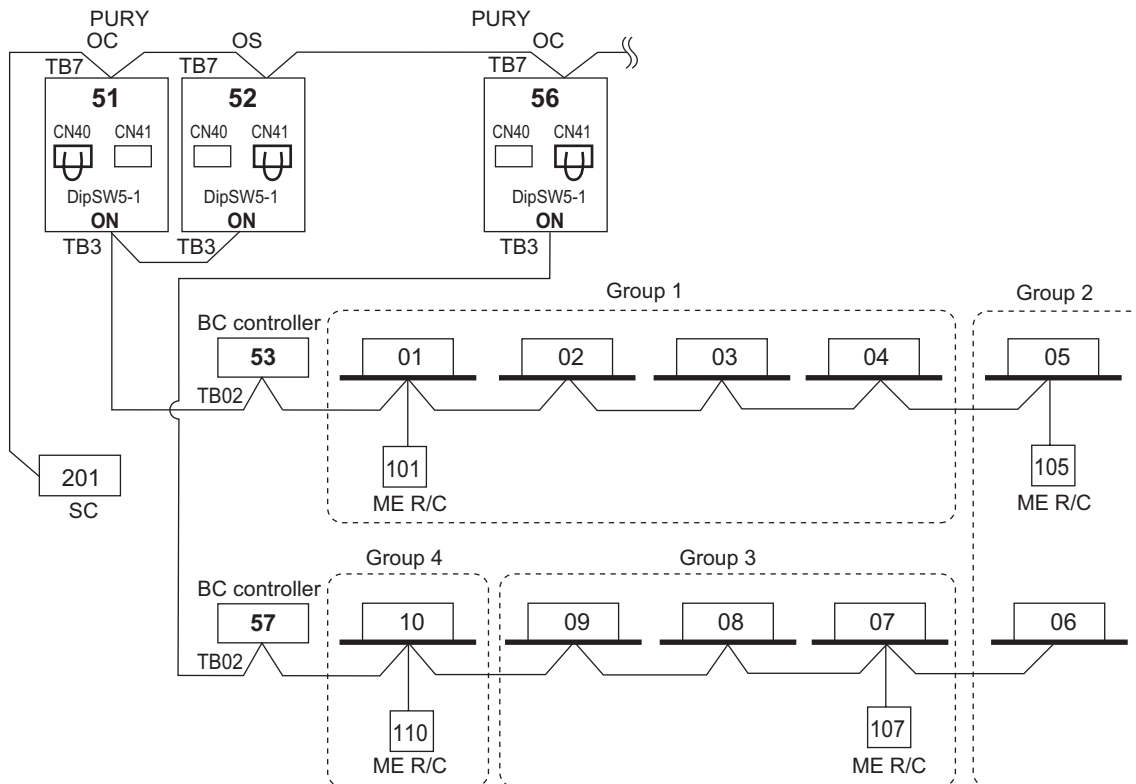

NOTE

- It is necessary to change the connector to CN40 on the outdoor unit control board (only one outdoor unit) when the group is set between other refrigerant systems.
- Up to three System controllers can be connected to TB3 side.

PURY-EP-T(S)NU-A, Y(S)NU-A

11-4-3-10. AE-200A + AE-50A/EW-50A

AE-200A can control max. 200 indoor units/via AE-50A.

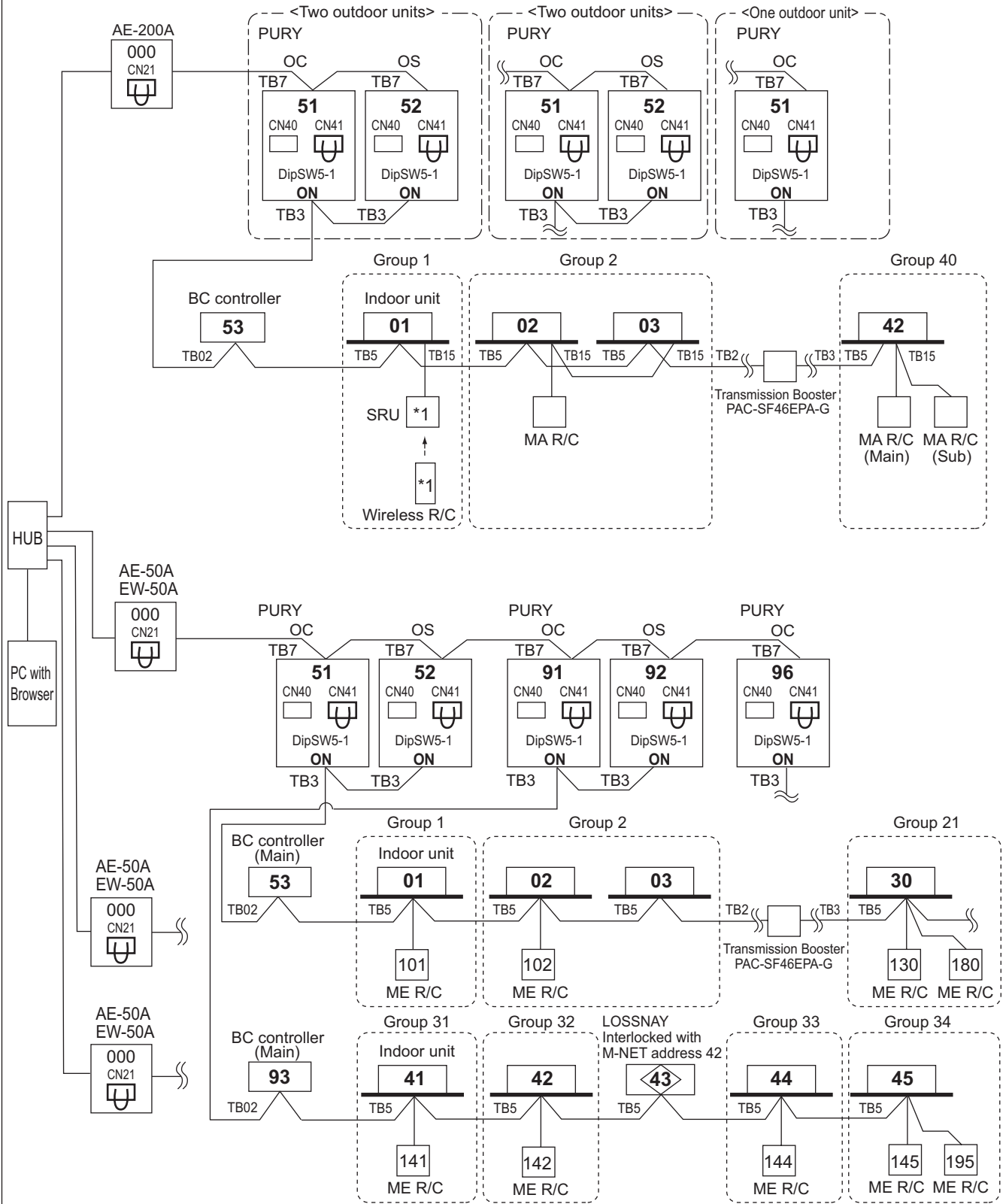

*1 For Wireless R/C and Signal receiver unit (SRU), channel 1, 2 and 3 are selectable and should be set to same channel.
 *2 When the PAR-CT01MA series, PAR-FS01MA series, PAR-4"x"MA series, or PAR-3"x"MA series ("x" represents 0 or later) is connected to a group, no other MA remote controllers can be connected to the same group.

11-4-3-11. BACnet®

EW-50A (AE-200A) can control up to 50 units/groups (including LOSSNAY).

*To use the BACnet® function on EW-50A (AE-200A), BACnet® license registration is required.

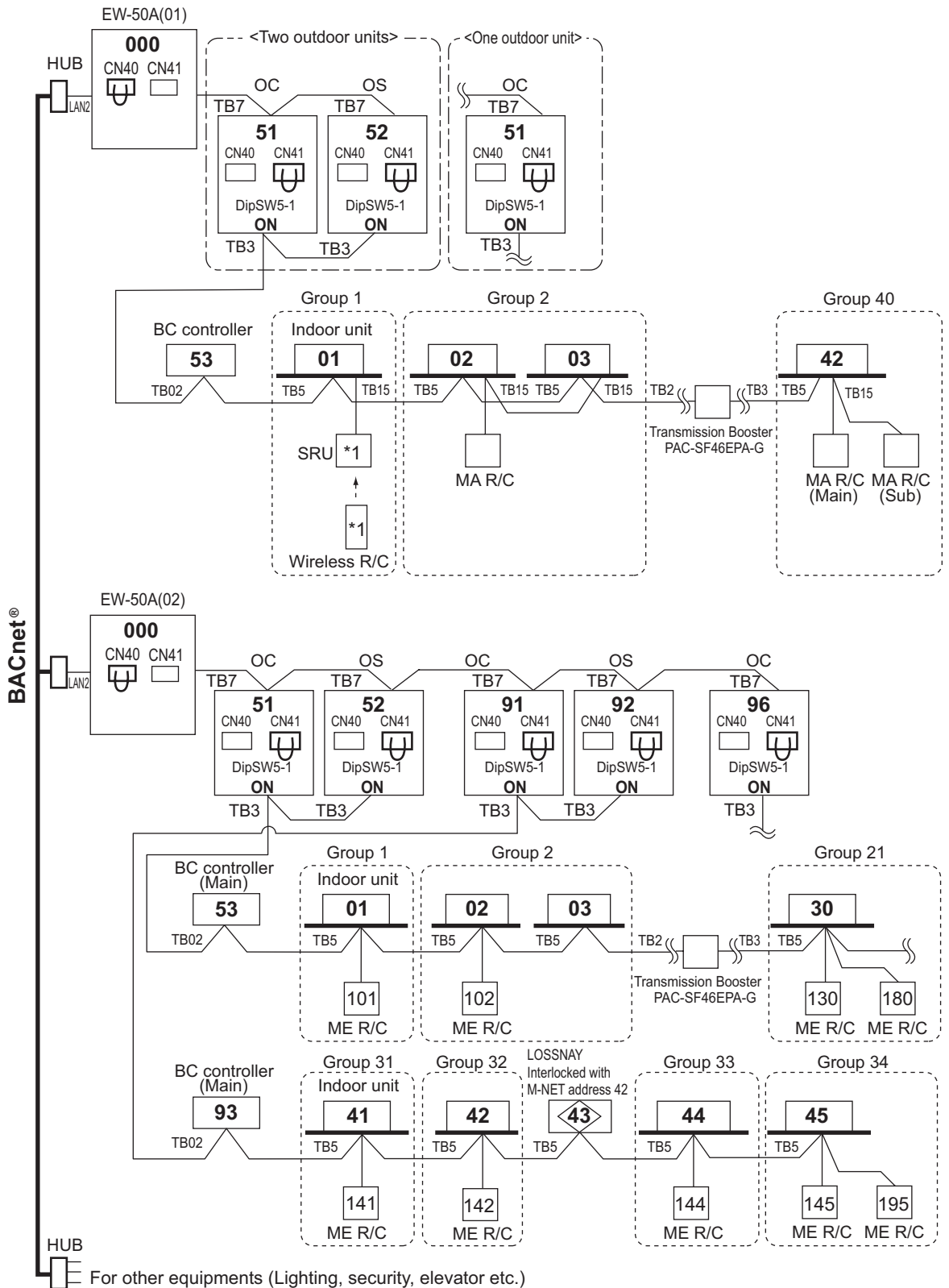

*1 For Wireless R/C and Signal receiver unit (SRU), channel 1, 2 and 3 are selectable and should be set to same channel.

*2 When the PAR-CT01MA series, PAR-FS01MA series, PAR-4"x"MA series, or PAR-3"x"MA series ("x" represents 0 or later) is connected to a group, no other MA remote controllers can be connected to the same group.

12-1. R410A Piping material

Refrigerant pipe for CITY MULTI shall be made of phosphorus deoxidized copper, and has two types.

A. Type-O: Soft copper pipe (annealed copper pipe), can be easily bent with human's hand.

B. Type-1/2H pipe: Hard copper pipe (Straight pipe), being stronger than Type-O pipe of the same radical thickness.

The maximum operation pressure of R410A air conditioner is 4.30 MPa [623psi]. The refrigerant piping should ensure the safety under the maximum operation pressure. MITSUBISHI ELECTRIC recommends pipe size as Table1, or You shall follow the local industrial standard. Pipes of radical thickness 0.7mm or less shall not be used.

Table 1. Copper pipe size and radial thickness for R410A CITY MULTI.

Size (mm)	Size (in.)	Radial thickness (mm)	Radial thickness (mil)	Pipe type
ø6.35	ø1/4"	0.8	[32]	Type-O
ø9.52	ø3/8"	0.8	[32]	Type-O
ø12.7	ø1/2"	0.8	[32]	Type-O
ø15.88	ø5/8"	1.0	[40]	Type-O
ø19.05	ø3/4"	1.2	[48]	Type-O
ø19.05	ø3/4"	1.0	[40]	Type-1/2H or H
ø22.2	ø7/8"	1.0	[40]	Type-1/2H or H
ø25.4	ø1"	1.0	[40]	Type-1/2H or H
ø28.58	ø1-1/8"	1.0	[40]	Type-1/2H or H
ø31.75	ø1-1/4"	1.1	[44]	Type-1/2H or H
ø34.93	ø1-3/8"	1.2	[48]	Type-1/2H or H
ø41.28	ø1-5/8"	1.4	[56]	Type-1/2H or H

* For pipe sized ø19.05 (3/4") for R410A air conditioner, choice of pipe type is up to you.

* The figures in the radial thickness column are based on the Japanese standards and provided only as a reference. Use pipes that meet the local standards.

Flare

Due to the relative higher operation pressure of R410A compared to R22, the flare connection should follow dimensions mentioned below so as to achieve enough the air-tightness.

Flare pipe	Pipe size	A (For R410A) (mm[in.])	Flare nut	Pipe size	B (For R410A) (mm[in.])
	ø6.35 [1/4"]	9.1		ø6.35 [1/4"]	17.0
	ø9.52 [3/8"]	13.2		ø9.52 [3/8"]	22.0
	ø12.70 [1/2"]	16.6		ø12.70 [1/2"]	26.0
	ø15.88 [5/8"]	19.7		ø15.88 [5/8"]	29.0
	ø19.05 [3/4"]	24.0		ø19.05 [3/4"]	36.0

PURY-EP-T(S)NU-A, Y(S)NU-A

Procedures for installing the branched pipes

Refer to the instructions that came with the branched pipe kit (separately sold) for details.

[1] Branches on the indoor-unit side

- Restriction on installing the branch joint between Main BC and Sub BC on the high-pressure piping, low-pressure piping, and liquid piping.

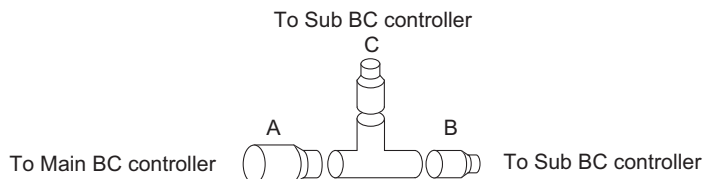

- Regarding the branch joint between Main BC and Sub BC on the high-pressure/low-pressure/liquid piping, A and B must be installed horizontally, and C must be installed upward higher than the horizontal plane of A and B.

[2] Branches on the outdoor/heat source-unit side

Note. Refer to the figure below for the installation position of the twinning pipe.

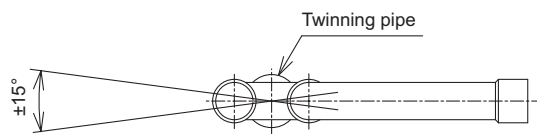

Slope of the twinning pipes are at an angle within $\pm 15^\circ$ to the horizontal plane.

- Inclination of the twinning pipes
The inclination of the twinning pipes must be $\pm 15^\circ$ or less against the horizontal plane.
Excessive inclination of the branched pipes may damage the unit.
- Minimum length of the straight section of the pipe before the branched pipes
Always use the pipes supplied in the branched pipe kit, and make sure the straight section of the pipe immediately before it connects to the branched pipe is at least 500 mm (19-11/16 in.). Failure to do so may damage the unit.

12-2. Piping Design

"BC controller," "BC controller (Main)," and "BC controller (Sub)" that appear in this section refer to the J-type, JA/KA type, and KB type.

12-2-1. IF 16 ports or less are in use, i.e., if only one BC controller is in use with no sub BC controller.

- Note1. No Header usable on PURY system.
- Note2. Indoor unit sized P72-P96 should be connected to BC controller via Y shape joint CMY-R160-J1.
- Note3. Indoor unit sized P72-P96 does NOT share BC controller ports with other Indoor units ;
- Note4. As bents cause pressure loss on transportation of refrigerant, fewer bents design is better ;
Piping length needs to consider the actual length and equivalent length which bents are counted.
Equivalent piping length (m)=Actual piping length+"M" x Number of bent.
- Note5. Set DIP-SW 4-6 to ON of BC controller, in case of connected Indoor unit sized P72-P96 with 2 ports.
- Note6. Do not connect multiple indoor units to the same port when operating each of them in different mode (cooling, heating, stop, and thermo-off). In case of connecting multiple indoor units to the same port, connecting all indoor units to one remote controller and switching SW1-1 ON in the all connected indoor units (switch to thermostat built in the remote controller) are recommended.
- Note7. Indoor capacity is described as its model size. For example, PEFY-P24NMAU-E3, its capacity is P24.
- Note8. Total down-stream Indoor capacity is the summary of the model size of Indoors down-stream. For example, PEFY-P24NMAU-E3 + PEFY-P06NMAU-E3: Total Indoor capacity = P24 + P06 = P30.
- Note9. To connect the BC controller to the main pipe, use the reducer (CMY-R301S-G, CMY-R302S-G1, or CMY-R304S-G1).
- Note10. Install the pipes correctly referring to the section titled "Procedures for installing the branched pipes."

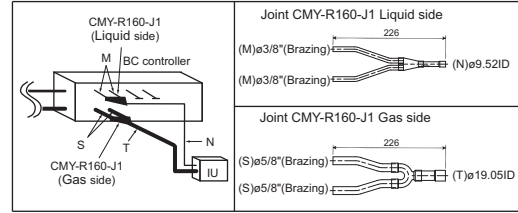

Fig. 12-2-1AA

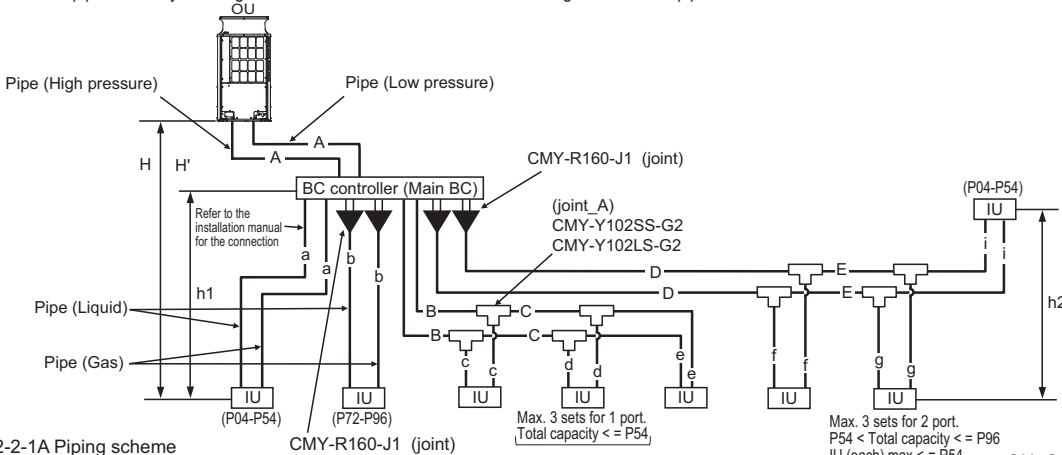

Fig. 12-2-1A Piping scheme

Piping length limitation *8

Item	Piping in the figure	Max. length	Max. equivalent length
Total piping length (Total length of high pressure and liquid pipes)	A+B+C+D+E+a+b+c+d+e+f+g+i	*1	-
Farthest IU from OU	A+D+E+i	165 [541']	190 [623']
Distance between OU and BC	A	110 [360'] *1	110 [360'] *1
Farthest IU from BC controller	D+E+i	60 [197'] *2*3	60 [197'] *2*3
Height between OU and IU (OU above IU)	H	50 [164'] *6	-
Height between OU and IU (OU under IU)	H'	40 [131'] *7	-
Height between IU and BC	h1	15 [49'] (10 [32']) *4	-
Height between IU and IU	h2	30 [98'] (20 [65']) *5	-

Bent equivalent length

Outdoor Model	M (m/bent [ft./bent])
EP72T/YNU	0.35 [1.15']
EP96T/YNU	0.42 [1.38']
EP120T/YNU	0.50 [1.64']
EP144T/YNU	0.50 [1.64']
EP168T/YNU	0.50 [1.64']
EP192T/YNU	0.50 [1.64']
EP216T/YNU	0.50 [1.64']
EP240T/YNU	0.50 [1.64']

OU: Outdoor Unit; IU: Indoor Unit; BC: BC controller

*1. Refer to the section 12-2-4.

*2. Details refer to Fig. 1.

*3. When the P72 or P96 model of indoor units are connected to the system, the maximum distance from the BC controller to the farthest indoor unit (indicated as "D + E + i" in the figure is 40 meters.)

*4. Distance of Indoor sized P72, P96 from BC must be less than 10 m, if any.

*5. Distance of Indoor sized P72, P96 from IU must be less than 20 m, if any.

*6. 90 m is available depending on the model and installation conditions. For more detailed information, contact your local distributor.

*7. 60 m is available depending on the model and installation conditions. For more detailed information, contact your local distributor.

*8. Total length of high-pressure pipes and liquid pipes

*9. When the high pressure piping length is 65 m or less, use ø22.2 (ø7/8) pipe.

When the high pressure piping length exceeds 65 m, use ø28.58 (ø1-1/8) pipe until 65 m, use ø28.58 (ø1-1/8) pipe for the part that exceeds 65 m.

Fig. 1 Piping length and height between IU and BC controller

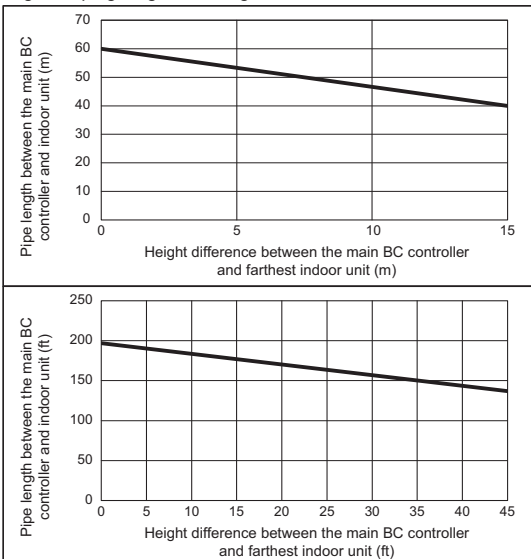

Piping "A" size selection rule

Outdoor Model	Pipe(High pressure)	Pipe(Low pressure)
EP72T/YNU	ø15.88 [5/8"]	ø19.05 [3/4"]
EP96T/YNU	ø19.05 [3/4"]	ø22.20 [7/8"]
EP120T/YNU	ø19.05 [3/4"]	ø28.58 [1-1/8"]
EP144T/YNU	ø22.20 [7/8"]	ø28.58 [1-1/8"]
EP168T/YNU	ø22.20 [7/8"]	ø28.58 [1-1/8"]
EP192T/YNU	ø22.20 [7/8"]	ø28.58 [1-1/8"]
EP216T/YNU	ø22.20 [7/8"]*9	ø34.93 [1-3/8"]
EP240T/YNU	ø22.20 [7/8"]*9	ø34.93 [1-3/8"]

Piping "B", "C", "D", "E" size selection rule

Total down-stream Indoor capacity	Pipe(Liquid)	Pipe(Gas)
P54 or less	ø9.52 [3/8"]	ø15.88 [5/8"]
P55-P72	ø9.52 [3/8"]	ø19.05 [3/4"]
P73-P96	ø9.52 [3/8"]	ø22.20 [7/8"]

Piping "a", "b", "c", "d", "e", "f", "g", "i" size selection rule

Indoor Unit size	Pipe(Liquid)	Pipe(Gas)
P04-P18	ø6.35 [1/4"]	ø12.70 [1/2"]
P24-P54	ø9.52 [3/8"]	ø15.88 [5/8"]
P72	ø9.52 [3/8"]	ø19.05 [3/4"]
P96	ø9.52 [3/8"]	ø22.20 [7/8"]

Selection criteria for joints_A

Total down-stream Indoor capacity	Joint
-P72	CMY-Y102SS-G2
P73-P96	CMY-Y102LS-G2

PURY-EP-T(S)NU-A, Y(S)NU-A

12-2-2. IF more than 16 ports are in use, or if there is more than one BC controller in use for one outdoor unit

- Note1. No Header usable on PURY system.
- Note2. Indoor unit sized P72-P96 should be connected to BC controller via Y shape joint CMY-R160-J1.
- Note3. Indoor unit sized P72-P96 does NOT share BC controller ports with other Indoor units ;
- Note4. As bents cause pressure loss on transportation of refrigerant, fewer bents design is better ;
Piping length needs to consider the actual length and equivalent length which bents are counted.
Equivalent piping length (m)=Actual piping length+“M” x Number of bent.
- Note5. Set DIP-SW 4-6 to ON of BC controller, in case of connected Indoor unit sized P72-P96 with 2 ports.
- Note6. Do not connect multiple indoor units to the same port when operating each of them in different mode (cooling, heating, stop, and thermo-off). In case of connecting multiple indoor units to the same port, connecting all indoor units to one remote controller and switching SW1-1 ON in the all connected indoor units (switch to thermostat built in the remote controller) are recommended.
- Note7. The maximum total capacity of indoor units that can be connected to each sub BC controller CMB-P*NU-KB1 is 126.
- Note8. Indoor capacity is described as its model size. For example, PEFY-P24NMAU-E3, its capacity is P24.
- Note9. Total down-stream Indoor capacity is the summary of the model size of Indoors down-stream. For example, PEFY-P24NMAU-E3 + PEFY-P06NMAU-E3 : Total Indoor capacity = P24 + P06 = P30.
- Note10. To connect the BC controller to the main pipe, use the reducer (CMY-R301S-G, CMY-R302S-G1, or CMY-R304S-G1).
- Note11. To connect the sub BC controller to the main BC controller, use the reducer (CMY-R303S-G1, CMY-R305S-G1, or CMY-R306S-G).
- Note12. Install the pipes correctly referring to the section titled "Procedures for installing the branched pipes."
- Note13. Up to 11 sub BC controllers can be connected.

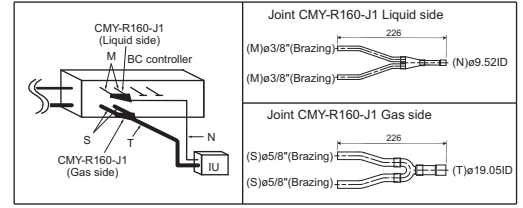

Fig. 12-2-2AA

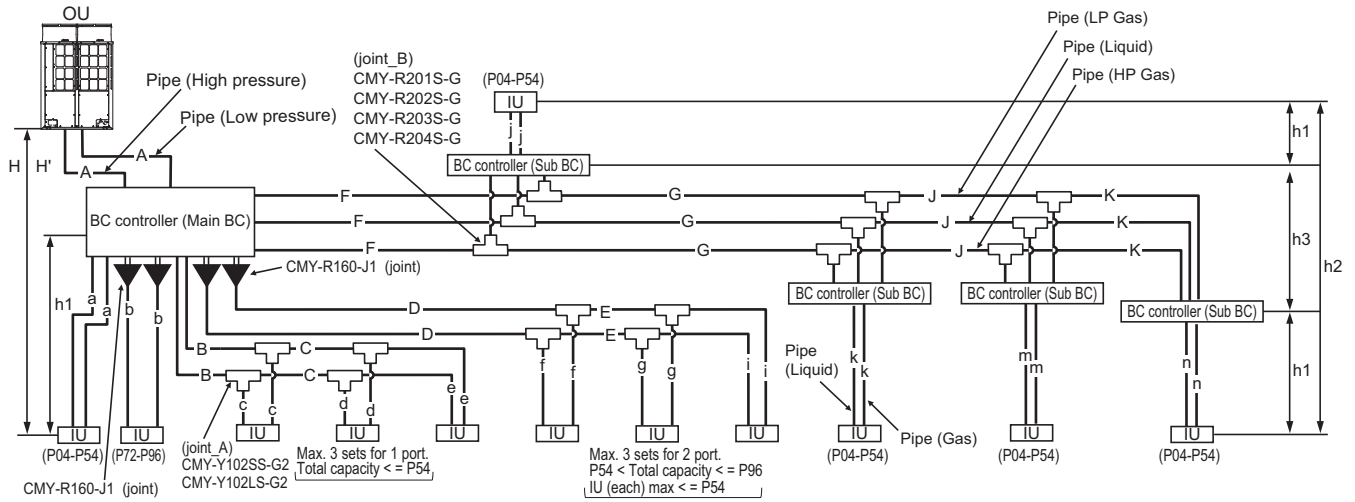

Fig. 12-2-2A Piping scheme

OU: Outdoor unit, IU: Indoor unit

Piping length limitation *11

Item	Piping in the figure	Max. length	Max. equivalent length
Total piping length (Total length of high pressure and liquid pipes)	A+B+C+D+E+F+G+J+K+a+b+c+d+e+f+g+i+j+k+m+n	*1	-
Farthest IU from OU	A+F+G+J+K+n	165 [541']	190 [623']
Distance between OU and BC	A	110 [360'] *1	110 [360'] *1
Farthest IU from BC controller	D+E+i	60 [197'] *2*3	60 [197'] *2*3
Farthest IU from BC controller via Sub BC controller	F+G+J+K+n	90 [295'] *9	90 [295'] *9
Height between OU and IU (OU above IU)	H	50 [164'] *7	-
Height between OU and IU (OU under IU)	H'	40 [131'] *8	-
Height between IU and BC	h1	15 [49'] (10 [32']) *4	-
Height between IU and IU	h2	30 [98'] (20 [65']) *5	-
Height between BC(Main or Sub) and BC(Sub)	h3	15 [49'] (10 [32']) *6	-

OU: Outdoor Unit; IU: Indoor Unit; BC: BC controller

- *1. Refer to the section 12-2-4.
- *2. Details refer to Fig. 2.
- *3. When the P72 or P96 model of indoor units are connected to the system, the maximum distance from the BC controller to the farthest indoor unit (indicated as "D + E + i" in the figure is 40 meters.)
- *4. Distance of Indoor sized P72, P96 from BC must be less than 10 m, if any.
- *5. Distance of Indoor sized P72, P96 from IU must be less than 20 m, if any.
- *6. When using 2 or more Sub BC controllers, max. height "h3" should be considered.
- *7. 90 m is available depending on the model and installation conditions. For more detailed information, contact your local distributor.
- *8. 60 m is available depending on the model and installation conditions. For more detailed information, contact your local distributor.
- *9. When the piping length or the vertical separation exceeds the limit specified in Fig. 2, connect a sub BC to the system. The restriction for a system with a sub BC connection is shown in Fig. 3. When a given system configuration falls within the shaded area in Fig. 3, increase the size of the high-pressure pipe and the liquid pipe between the main BC and sub BC by one size. When using P12, P15, P18, P36, or P48 model of indoor units, increase the size of the liquid branch pipe between the sub BC and indoor unit by one size. When using indoor models P54 or larger, the restrictions shown in Fig. 2 cannot be exceeded.
- *10. When the high pressure piping length is 65 m or less, use ø22.2 (ø7/8) pipe.
- When the high pressure piping length exceeds 65 m, use ø22.2 (ø7/8) pipe until 65 m, use ø28.58 (ø1-1/8) pipe for the part that exceeds 65 m.
- *11. Total length of high-pressure pipes and liquid pipes

Bent equivalent length

Outdoor Model	M(m/bent [ft./bent])
EP72T/YNU	0.35 [1.15']
EP96T/YNU	0.42 [1.38']
EP120T/YNU	0.50 [1.64']
EP144T/YNU	0.50 [1.64']
EP168T/YNU	0.50 [1.64']
EP192T/YNU	0.50 [1.64']
EP216T/YNU	0.50 [1.64']
EP240T/YNU	0.50 [1.64']

Piping length and height between IU and BC controller

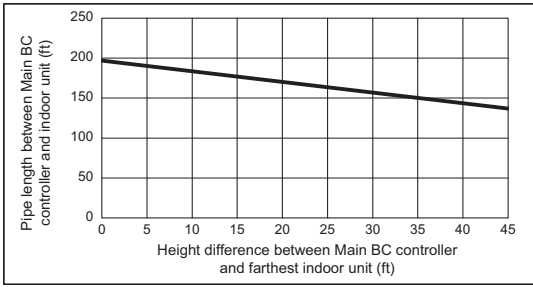

Fig. 2

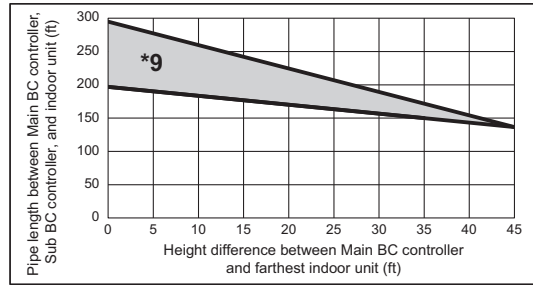
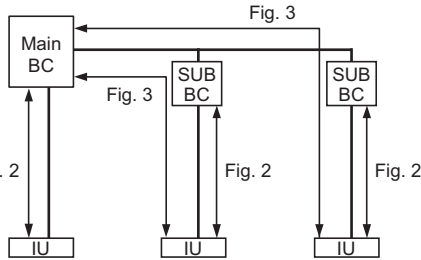

Fig. 3



*9. When the piping length or the vertical separation exceeds the limit specified in Fig. 2, connect a sub BC to the system.

The restriction for a system with a sub BC connection is shown in Fig. 3.

When a given system configuration falls within the shaded area in Fig. 3, increase the size of the high-pressure pipe and the liquid pipe between the main BC and sub BC by one size.

The maximum liquid branch pipe diameter is $\phi 19.05$. If a given system already has a $\phi 19.05$ -pipe between the main BC and sub BC, there is no need to increase the pipe size.

When using P12, P15, P18, P36, or P48 model of indoor units, increase the size of the liquid branch pipe between the sub BC and indoor unit by one size.

When using indoor models P54 or larger, the restrictions shown in Fig. 2 cannot be exceeded.

Piping "A" size selection rule

Outdoor Model	Pipe(High pressure)	Pipe(Low pressure)
EP72T/YNU	$\phi 15.88$ [5/8"]	$\phi 19.05$ [3/4"]
EP96T/YNU	$\phi 19.05$ [3/4"]	$\phi 22.20$ [7/8"]
EP120T/YNU	$\phi 19.05$ [3/4"]	$\phi 28.58$ [1-1/8"]
EP144T/YNU	$\phi 22.20$ [7/8"]	$\phi 28.58$ [1-1/8"]
EP168T/YNU	$\phi 22.20$ [7/8"]	$\phi 28.58$ [1-1/8"]
EP192T/YNU	$\phi 22.20$ [7/8"]	$\phi 28.58$ [1-1/8"]
EP216T/YNU	$\phi 22.20$ [7/8"]*10	$\phi 34.93$ [1-3/8"]
EP240T/YNU	$\phi 22.20$ [7/8"]*10	$\phi 34.93$ [1-3/8"]

Selection criteria for joints_A

Total down-stream Indoor capacity	Joint
-P72	CMY-Y102SS-G2
P73-P96	CMY-Y102LS-G2

Piping "B", "C", "D", "E" size selection rule

Total down-stream Indoor capacity	Pipe(Liquid)	Pipe(Gas)
P54 or less	$\phi 9.52$ [3/8"]	$\phi 15.88$ [5/8"]
P55-P72	$\phi 9.52$ [3/8"]	$\phi 19.05$ [3/4"]
P73-P96	$\phi 9.52$ [3/8"]	$\phi 22.20$ [7/8"]

Selection criteria for joints_B

Total down-stream Indoor capacity	Joint
-P126	CMY-R201S-G
P127-P216	CMY-R202S-G
P217-P234	CMY-R203S-G
P235-P360	CMY-R204S-G

Piping "a", "b", "c", "d", "e", "f", "g", "i", "j", "k", "m", "n" size selection rule (mm [in.])

Indoor Unit size	Pipe(Liquid)	Pipe(Gas)
P04-P18	$\phi 6.35$ [1/4"]	$\phi 12.70$ [1/2"]
P24-P54	$\phi 9.52$ [3/8"]	$\phi 15.88$ [5/8"]
P72	$\phi 9.52$ [3/8"]	$\phi 19.05$ [3/4"]
P96	$\phi 9.52$ [3/8"]	$\phi 22.20$ [7/8"]

Piping "F", "G", "J", "K" size selection rule

Total down-stream Indoor capacity	Pipe(Liquid)	Pipe(HP Gas)	Pipe(LP Gas)
P72 or less	$\phi 9.52$ [3/8"]	$\phi 15.88$ [5/8"]	$\phi 19.05$ [3/4"]
P73 to P108	$\phi 9.52$ [3/8"]	$\phi 19.05$ [3/4"]	$\phi 22.20$ [7/8"]
P109 to P126	$\phi 12.70$ [1/2"]	$\phi 19.05$ [3/4"]	$\phi 28.58$ [1-1/8"]
P127 to P144	$\phi 12.70$ [1/2"]	$\phi 22.20$ [7/8"]	$\phi 28.58$ [1-1/8"]
P145 to P216	$\phi 15.88$ [5/8"]	$\phi 22.20$ [7/8"]	$\phi 28.58$ [1-1/8"]
P217 to P234	$\phi 15.88$ [5/8"]	$\phi 28.58$ [1-1/8"]	$\phi 28.58$ [1-1/8"]
P235 to P288	$\phi 19.05$ [3/4"]	$\phi 28.58$ [1-1/8"]	$\phi 34.93$ [1-3/8"]
P289 or above	$\phi 19.05$ [3/4"]	$\phi 28.58$ [1-1/8"]	$\phi 41.28$ [1-5/8"]

HP: High pressure, LP: Low pressure

PURY-EP-T(S)NU-A, Y(S)NU-A

12-2-3. IF more than 16 ports are in use, or if there is more than one BC controller in use for two outdoor units

- Note1. No Header usable on PURY system.
- Note2. Indoor unit sized P72-P96 should be connected to BC controller via Y shape joint CMY-R160-J1.
- Note3. Indoor unit sized P72-P96 does NOT share BC controller ports with other Indoor units ;
- Note4. As bents cause pressure loss on transportation of refrigerant, fewer bents design is better ;
Piping length needs to consider the actual length and equivalent length which bents are counted.
Equivalent piping length (m)=Actual piping length+"M" x Number of bent.
- Note5. Set DIP-SW 4-6 to ON of BC controller, in case of connected Indoor unit sized P72-P96 with 2 ports.
- Note6. Do not connect multiple indoor units to the same port when operating each of them in different mode (cooling, heating, stop, and thermo-off). In case of connecting multiple indoor units to the same port, connecting all indoor units to one remote controller and switching SW1-1 ON in the all connected indoor units (switch to thermostat built in the remote controller) are recommended.
- Note7. The maximum total capacity of indoor units that can be connected to each sub BC controller CMB-P*NU-KB1 is P126.
- Note8. Indoor capacity is described as its model size. For example, PEFY-P24NMAU-E3, its capacity is P24.
- Note9. Total down-stream Indoor capacity is the summary of the model size of Indoors down-stream. For example, PEFY-P24NMAU-E3 + PEFY-P06NMAU-E3 : Total Indoor capacity = P24 + P06 = P30.
- Note10. To connect the BC controller to the main pipe, use the reducer (CMY-R301S-G, CMY-R302S-G1, or CMY-R304S-G1).
- Note11. To connect the sub BC controller to the main BC controller, use the reducer (CMY-R303S-G1, CMY-R305S-G1, or CMY-R306S-G).
- Note12. Install the pipes correctly referring to the section titled "Procedures for installing the branched pipes."
- Note13. Up to 11 sub BC controllers can be connected.

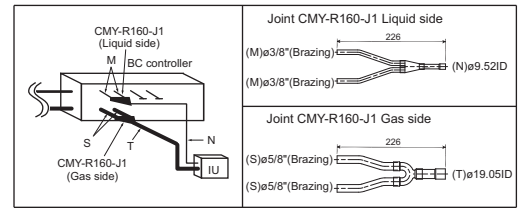

Fig. 12-2-3AA

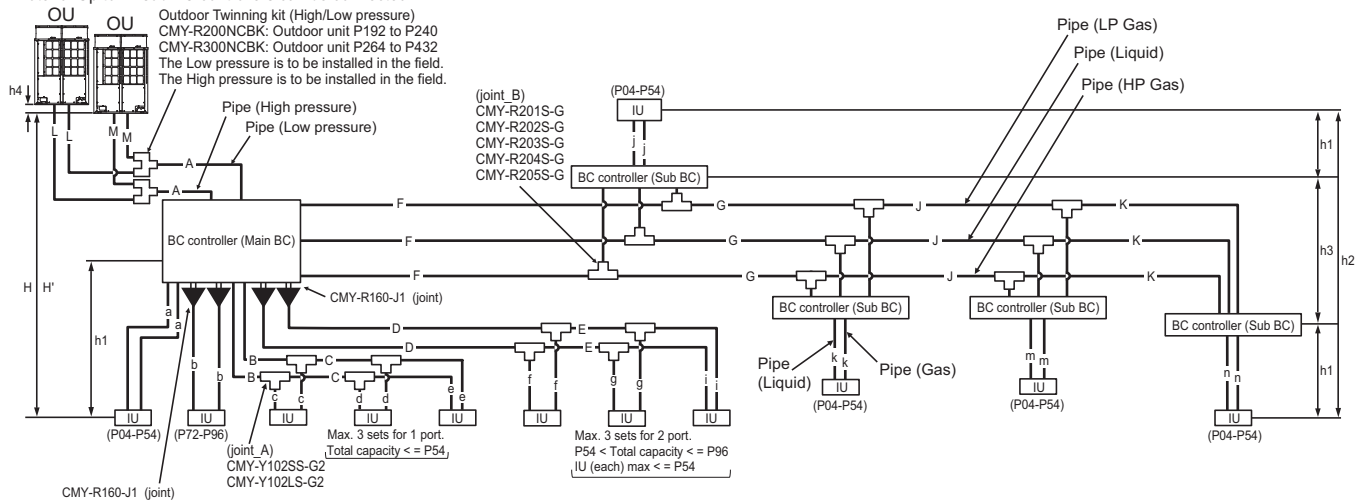

Fig. 12-2-3A Piping scheme

OU: Outdoor unit, IU: Indoor unit

Piping length limitation *11

Item	Piping in the figure	Max. length	Max. equivalent length
Total piping length (Total length of high pressure and liquid pipes)	L+M+A+B+C+D+E+F+G+J+K+a+b+c+d+e+f+g+i+j+k+m+n	*1	-
Farthest IU from OU	L(M)+A+F+G+J+K+n	165 [541']	190 [623']
Distance between OU and BC	L(M)+A	110 [360'] *1	110 [360'] *1
Farthest IU from BC controller	D+E+i	60 [197'] *2 *3	60 [197'] *2*3
Farthest IU from BC controller via Sub BC controller	F+G+J+K+n	90 [295'] *9	90 [295'] *9
Height between OU and IU (OU above IU)	H	50 [164'] *7	-
Height between OU and IU (OU under IU)	H'	40 [131'] *8	-
Height between IU and BC	h1	15 [49'] (10 [32']) *4	-
Height between IU and IU	h2	30 [98'] (20 [65']) *5	-
Height between BC(Main or Sub) and BC(Sub)	h3	15 [49'] (10 [32']) *6	-
Distance between Main unit and Sub unit	L+M	5 [16']	-
Height between Main unit and Sub unit	h4	0.1 [0.3']	-

OU: Outdoor Unit; IU: Indoor Unit; BC: BC controller

*1. Refer to the section 12-2-4.

*2. Details refer to Fig. 2.

*3. When the P72 or P96 model of indoor units are connected to the system, the maximum distance from the BC controller to the farthest indoor unit (indicated as "D + E + i" in the figure is 40 meters.)

*4. Distance of Indoor sized P72, P96 from BC must be less than 10 m, if any.

*5. Distance of Indoor sized P72, P96 from IU must be less than 20 m, if any.

*6. When using 2 or more Sub BC controllers, max. height "h3" should be considered.

*7. 90 m is available depending on the model and installation conditions. For more detailed information, contact your local distributor.

*8. 60 m is available depending on the model and installation conditions. For more detailed information, contact your local distributor.

*9. When the piping length or the vertical separation exceeds the limit specified in Fig. 2, connect a sub BC to the system.

The restriction for a system with a sub BC connection is shown in Fig. 3.

When a given system configuration falls within the shaded area in Fig. 3, increase the size of the high-pressure pipe and the liquid pipe between the main BC and sub BC by one size.

When using P12, P15, P18, P36, or P48 model of indoor units, increase the size of the liquid branch pipe between the sub BC and indoor unit by one size.

When using indoor models P54 or larger, the restrictions shown in Fig. 2 cannot be exceeded.

*10. When the high pressure piping length is 65 m or less, use ø22.2 (ø7/8) pipe.

When the high pressure piping length exceeds 65 m, use ø22.2 (ø7/8) pipe until 65 m, use ø28.58 (ø1-1/8) pipe for the part that exceeds 65 m.

*11. Total length of high-pressure pipes and liquid pipes

Bent equivalent length

Outdoor Model	M(m/bent [ft./bent])
EP192T/YGNU	0.50 [1.64']
EP216T/YGNU	0.50 [1.64']
EP240T/YGNU	0.50 [1.64']
EP264T/YGNU	0.70 [2.29']
EP288T/YGNU	0.70 [2.29']
EP312T/YGNU	0.70 [2.29']
EP336T/YGNU	0.80 [2.62']
EP384T/YGNU	0.80 [2.62']
EP432T/YGNU	0.80 [2.62']

Piping length and height between IU and BC controller

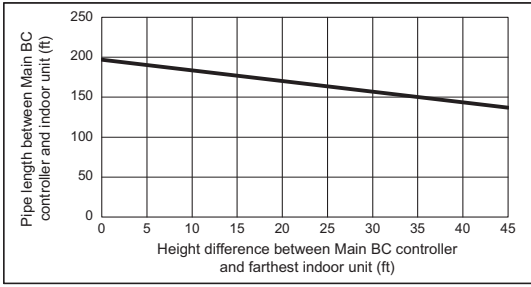

Fig. 2

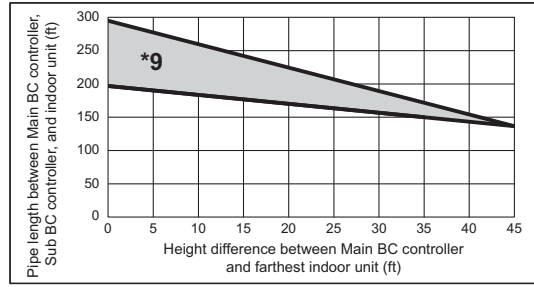
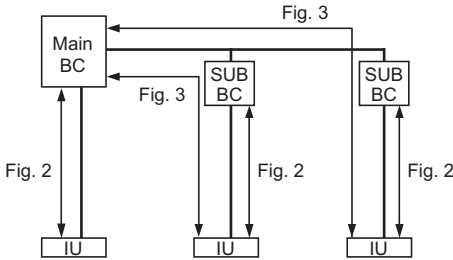

Fig. 3



*9. When the piping length or the vertical separation exceeds the limit specified in Fig. 2, connect a sub BC to the system.

The restriction for a system with a sub BC connection is shown in Fig. 3.

When a given system configuration falls within the shaded area in Fig. 3, increase the size of the high-pressure pipe and the liquid pipe between the main BC and sub BC by one size.

The maximum liquid branch pipe diameter is $\phi 19.05$. If a given system already has a $\phi 19.05$ -pipe between the main BC and sub BC, there is no need to increase the pipe size.

When using P12, P15, P18, P36, or P48 model of indoor units, increase the size of the liquid branch pipe between the sub BC and indoor unit by one size.

When using indoor models P54 or larger, the restrictions shown in Fig. 2 cannot be exceeded.

Piping "A" size selection rule (mm [in.])

Outdoor Model	Pipe(High pressure)	Pipe(Low pressure)
EP192T/YSNU	$\phi 22.20$ [7/8"]	$\phi 28.58$ [1-1/8"]
EP216T/YSNU	$\phi 22.20$ [7/8"] *10	$\phi 34.93$ [1-3/8"]
EP240T/YSNU	$\phi 22.20$ [7/8"] *10	$\phi 34.93$ [1-3/8"]
EP264T/YSNU	$\phi 28.58$ [1-1/8"]	$\phi 34.93$ [1-3/8"]
EP288T/YSNU	$\phi 28.58$ [1-1/8"]	$\phi 34.93$ [1-3/8"]
EP312T/YSNU	$\phi 28.58$ [1-1/8"]	$\phi 41.28$ [1-5/8"]
EP336T/YSNU	$\phi 28.58$ [1-1/8"]	$\phi 41.28$ [1-5/8"]
EP384T/YSNU	$\phi 28.58$ [1-1/8"]	$\phi 41.28$ [1-5/8"]
EP432T/YSNU	$\phi 28.58$ [1-1/8"]	$\phi 41.28$ [1-5/8"]

Piping "L", "M" size selection rule (mm [in.])

Outdoor Model	Pipe(High pressure)	Pipe(Low pressure)
EP72T/YNU	$\phi 15.88$ [5/8"]	$\phi 19.05$ [3/4"]
EP96T/YNU	$\phi 19.05$ [3/4"]	$\phi 22.20$ [7/8"]
EP120T/YNU	$\phi 19.05$ [3/4"]	$\phi 28.58$ [1-1/8"]
EP144T/YNU	$\phi 22.20$ [7/8"]	$\phi 28.58$ [1-1/8"]
EP168T/YNU	$\phi 22.20$ [7/8"]	$\phi 28.58$ [1-1/8"]
EP192T/YNU	$\phi 22.20$ [7/8"]	$\phi 28.58$ [1-1/8"]
EP216T/YNU	$\phi 22.20$ [7/8"]	$\phi 28.58$ [1-1/8"]

Piping "B", "C", "D", "E" size selection rule (mm [in.])

Total down-stream Indoor capacity	Pipe(Liquid)	Pipe(Gas)
P54 or less	$\phi 9.52$ [3/8"]	$\phi 15.88$ [5/8"]
P55-P72	$\phi 9.52$ [3/8"]	$\phi 19.05$ [3/4"]
P73-P96	$\phi 9.52$ [3/8"]	$\phi 22.20$ [7/8"]

Selection criteria for joints_A

Total down-stream Indoor capacity	Joint
-P72	CMY-Y102SS-G2
P73-P96	CMY-Y102LS-G2

Piping "a", "b", "c", "d", "e", "f", "g", "i", "j", "k", "m", "n" size selection rule (mm [in.])

Indoor Unit size	Pipe(Liquid)	Pipe(Gas)
P04-P18	$\phi 6.35$ [1/4"]	$\phi 12.70$ [1/2"]
P24-P54	$\phi 9.52$ [3/8"]	$\phi 15.88$ [5/8"]
P72	$\phi 9.52$ [3/8"]	$\phi 19.05$ [3/4"]
P96	$\phi 9.52$ [3/8"]	$\phi 22.20$ [7/8"]

Selection criteria for joints_B

Total down-stream Indoor capacity	Joint
-P126	CMY-R201S-G
P127-P216	CMY-R202S-G
P217-P234	CMY-R203S-G
P235-P360	CMY-R204S-G
P361-	CMY-R205S-G

Piping "F", "G", "J", "K" size selection rule (mm [in.])

Total down-stream Indoor capacity	Pipe(Liquid)	Pipe(HP Gas)	Pipe(LP Gas)
P72 or less	$\phi 9.52$ [3/8"]	$\phi 15.88$ [5/8"]	$\phi 19.05$ [3/4"]
P73 to P108	$\phi 9.52$ [3/8"]	$\phi 19.05$ [3/4"]	$\phi 22.20$ [7/8"]
P109 to P126	$\phi 12.70$ [1/2"]	$\phi 19.05$ [3/4"]	$\phi 28.58$ [1-1/8"]
P127 to P144	$\phi 12.70$ [1/2"]	$\phi 22.20$ [7/8"]	$\phi 28.58$ [1-1/8"]
P145 to P216	$\phi 15.88$ [5/8"]	$\phi 22.20$ [7/8"]	$\phi 28.58$ [1-1/8"]
P217 to P234	$\phi 15.88$ [5/8"]	$\phi 28.58$ [1-1/8"]	$\phi 28.58$ [1-1/8"]
P235 to P288	$\phi 19.05$ [3/4"]	$\phi 28.58$ [1-1/8"]	$\phi 34.93$ [1-3/8"]
P289 or above	$\phi 19.05$ [3/4"]	$\phi 28.58$ [1-1/8"]	$\phi 41.28$ [1-5/8"]

HP: High pressure, LP: Low pressure

PURY-EP-T(S)NU-A, Y(S)NU-A

12-2-4. Total piping length restrictions (m)

[PURY-EP72, 96TNU-A, PURY-EP72, 96YNU-A]

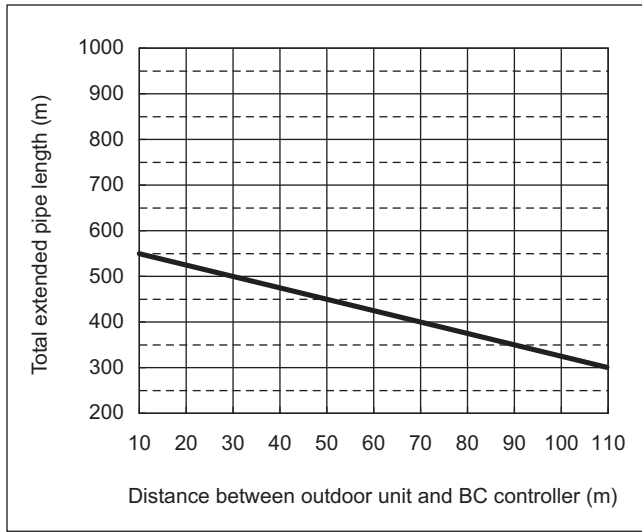

[PURY-EP192TSNU-A, PURY-EP192YSNU-A]

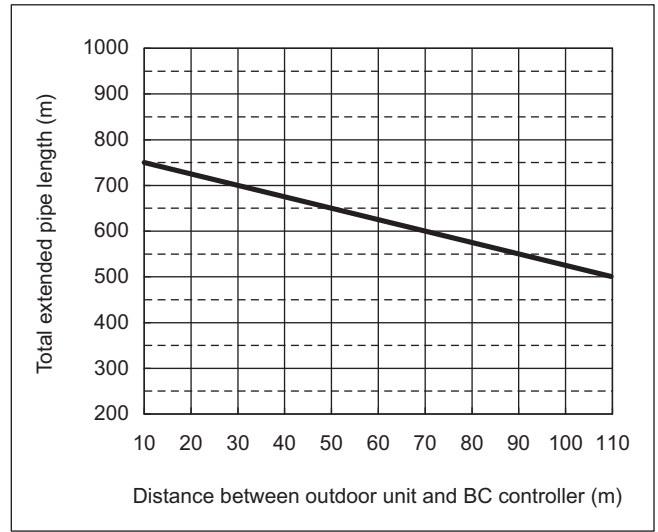

[PURY-EP120, 144, 168TNU-A, PURY-EP120, 144, 168YNU-A]

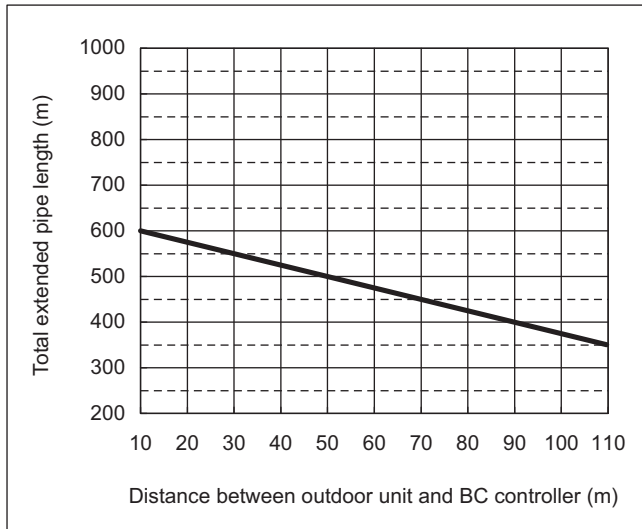

[PURY-EP216, 240TSNU-A, PURY-EP216, 240YSNU-A]

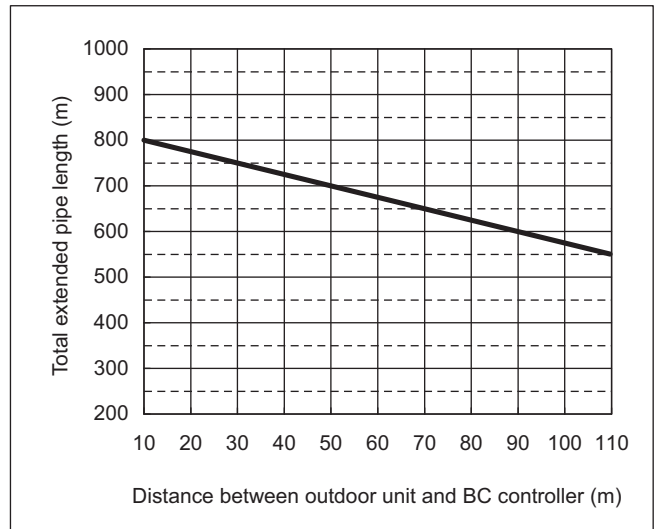

[PURY-EP192, 216, 240TNU-A, PURY-EP192, 216, 240YNU-A]

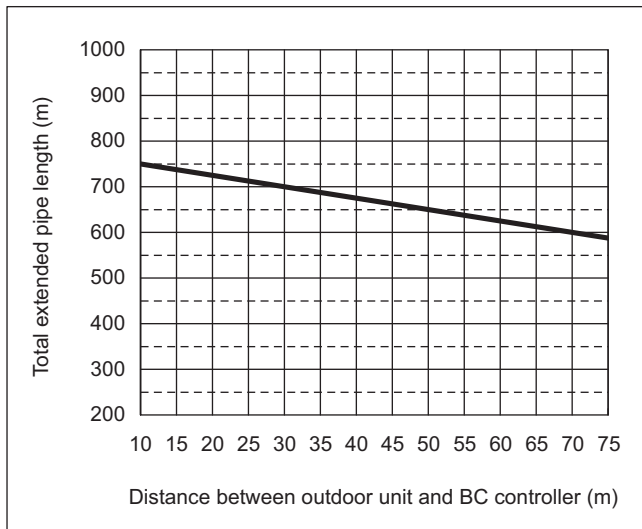

[PURY-EP264, 288, 312, 336TSNU-A, PURY-EP264, 288, 312, 336YSNU-A]

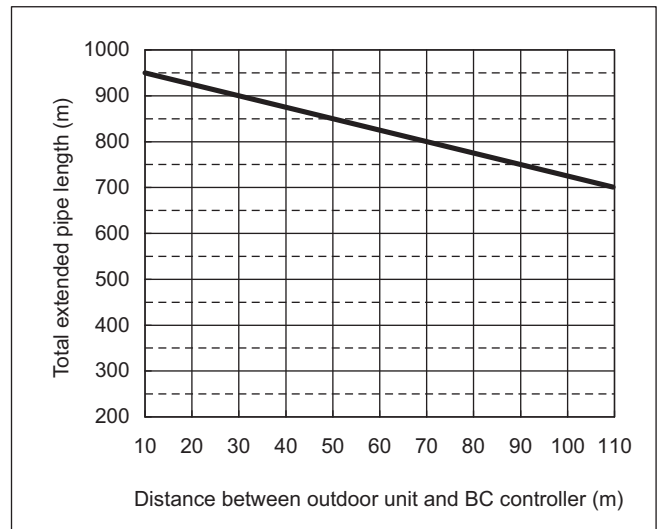

*110m is available depending on the model and installation condition. For more detailed information, please contact your local distributor.

[PURY-EP384, 432TSNU-A, PURY-EP384, 432YSNU-A]

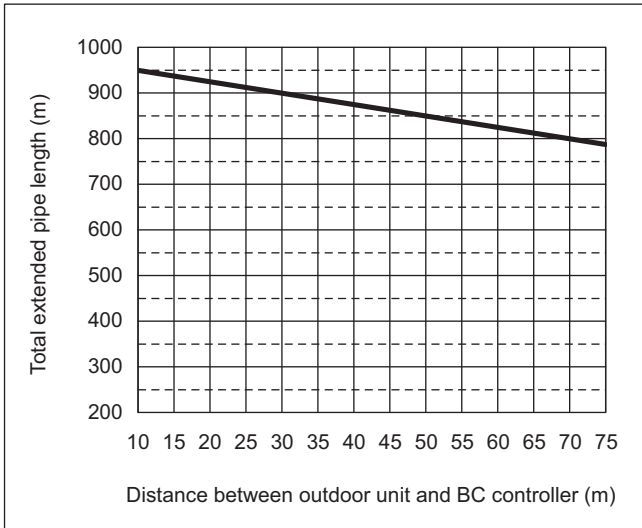

*110m is available depending on the model and installation condition.
For more detailed information, please contact your local distributor.

Total piping length restrictions(ft.)

[PURY-EP72, 96TNU-A, PURY-EP72, 96YNU-A]

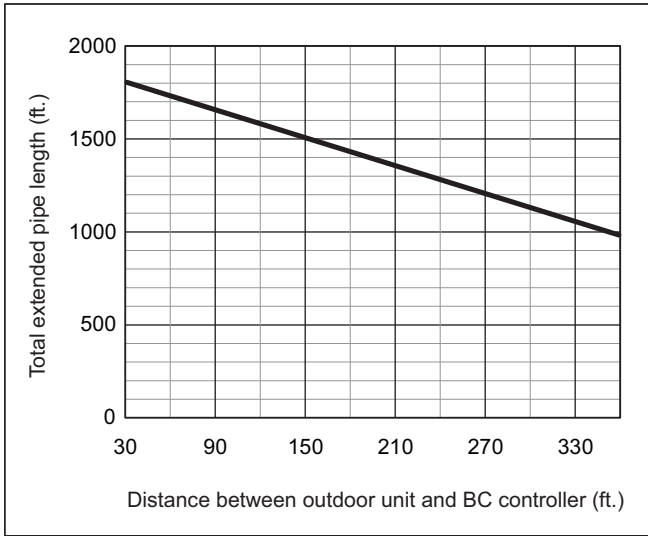

[PURY-EP192TSNU-A, PURY-EP192YSNU-A]

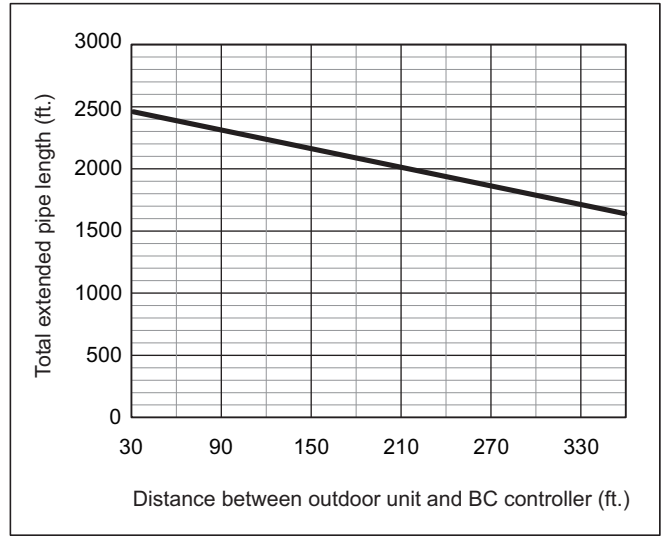

[PURY-EP120, 144, 168TNU-A, PURY-EP120, 144, 168YNU-A]

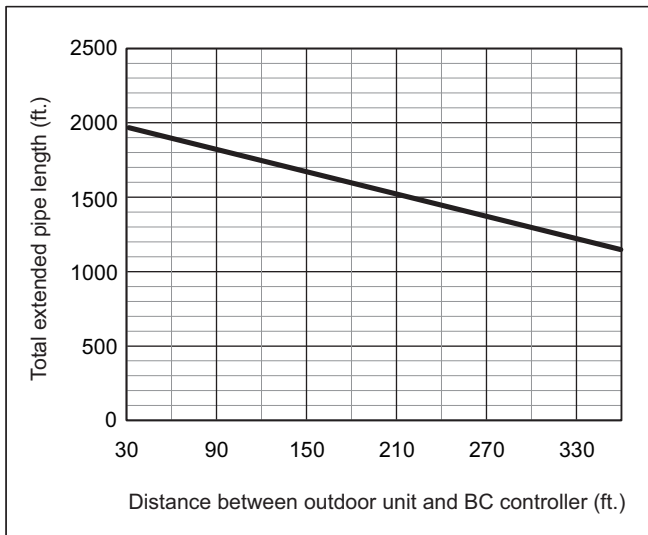

[PURY-EP216, 240TSNU-A, PURY-EP216, 240YSNU-A]

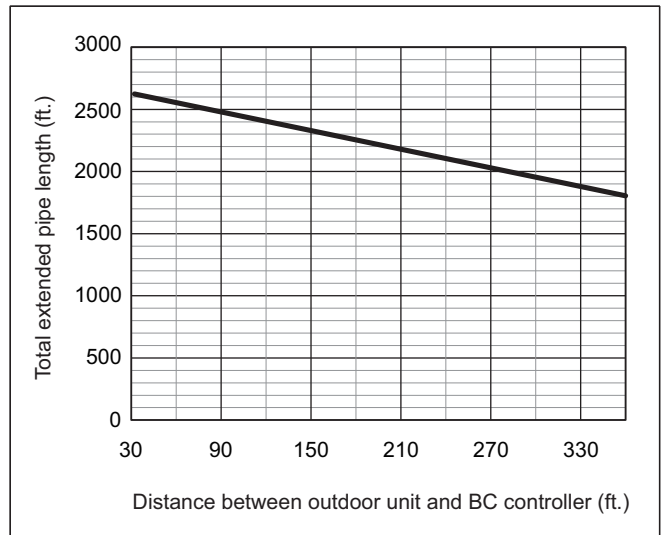

[PURY-EP192, 216, 240TNU-A, PURY-EP192, 216, 240YNU-A]

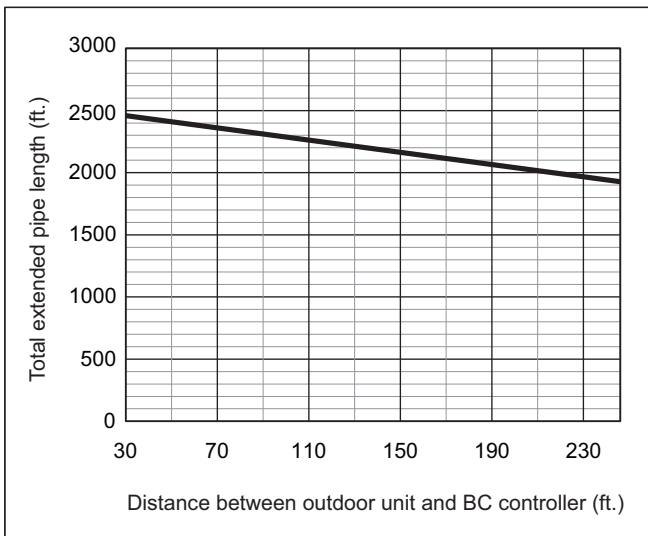

[PURY-EP264, 288, 312, 336TSNU-A, PURY-EP264, 288, 312, 336YSNU-A]

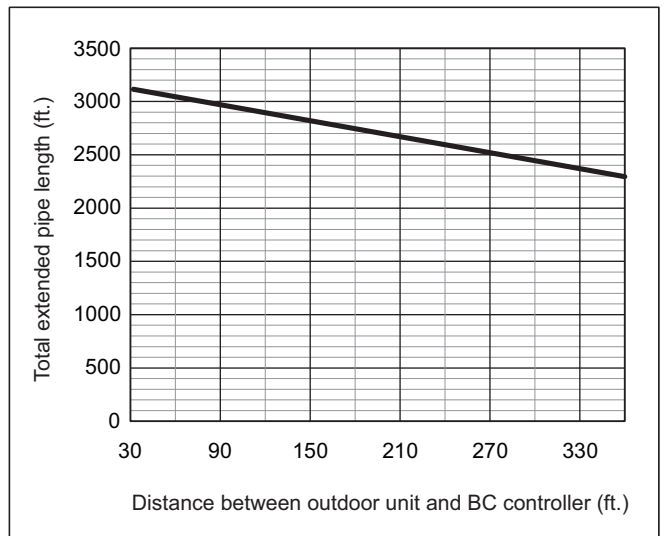

*360 ft. is available depending on the model and installation condition. For more detailed information, please contact your local distributor.

[PURY-EP384, 432TSNU-A, PURY-EP384, 432YSNU-A]

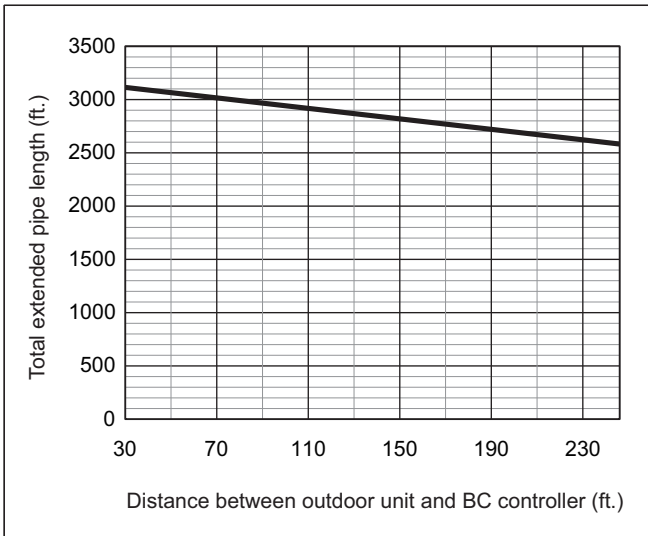

*360 ft. is available depending on the model and installation condition.
For more detailed information, please contact your local distributor.

12-3. Refrigerant charging calculation

Sample connection (with 5 BC controllers and 8 indoor units) (PURY-EP240YSNU-A)

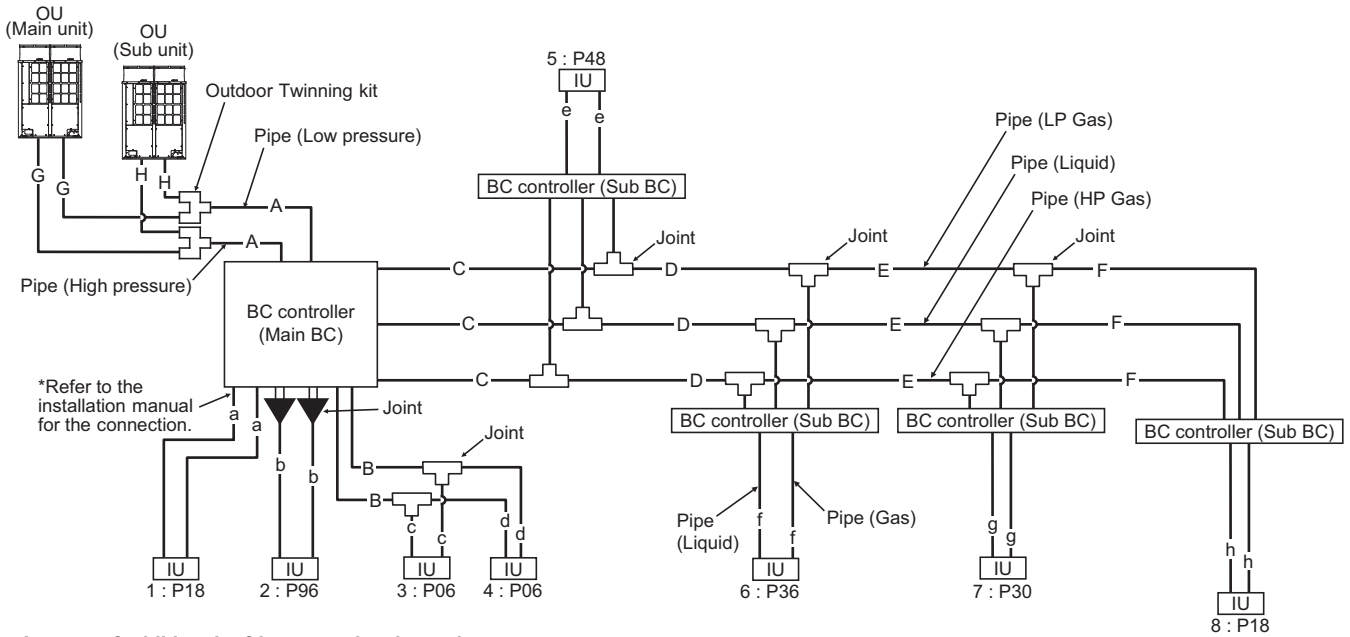

■ Amount of additional refrigerant to be charged

Refrigerant for extended pipes (field piping) is not factory-charged to the outdoor unit. Add an appropriate amount of refrigerant for each pipes on site. Record the size of each high pressure pipe and liquid pipe, and the amount of refrigerant that was charged on the outdoor unit for future reference.

■ Calculating the amount of additional refrigerant to be charged

The amount of refrigerant to be charged is calculated with the size of the on-site-installed high pressure pipes and liquid pipes, and their length. Calculate the amount of refrigerant to be charged according to the formula below. Round up the calculation result to the nearest 0.1kg. (i.e., 16.03 kg = 16.1 kg)

<Amount of additional refrigerant to be charged>

■ Calculating the amount of additional refrigerant to be charged

Units "m" and "kg" (In an R2 system)

<Formula>

• When the piping length from the outdoor unit to the farthest indoor unit is 30.5 m (100 ft) or shorter

Amount of additional charge (kg)	=	High-pressure pipe ø28.58 total length × 0.36 (kg/m)	+	High-pressure pipe ø22.2 total length × 0.23 (kg/m)	+	High-pressure pipe ø19.05 total length × 0.16 (kg/m)	+	High-puressure pipe ø15.88 total length × 0.11(kg/m)
		Liquid pipe ø19.05 total length × 0.29 (kg/m)	+	Liquid pipe ø15.88 total length × 0.2 (kg/m)	+	Liquid pipe ø12.7 total length × 0.12 (kg/m)	+	Liquid pipe ø9.52 total length × 0.06 (kg/m)

Main or Sub BC controller	Amount (kg/unit)	Total capacity of connected indoor units	Amount (kg) (to be added for indoor unit)	Total capacity of outdoor units	Amount (kg) (to be added for outdoor unit)	Total capacity of outdoor units	Amount (kg)
J-type	1.5	27 or below	2.0	72	0	72	1.5
JA-type	3.0	28 to 54	2.5	96	0	96	1.5
KA-type	4.7	55 to 126	3.0	120	0	120	3.0
KB-type	0.4	127 to 144	3.5	144	0	144	2.5
		145 to 180	4.5	168	0	168	4.0
		181 to 234	5.0	192 (single)	4.4	192 (single)	3.5
		235 to 273	6.0	216 (single)	4.4	216 (single)	4.0
		274 to 307	8.0	240 (single)	4.4	240 (single)	4.5
		308 to 342	9.0	192 (combination)	0	192 (combination)	4.0
		343 to 411	10.0	216 (combination)	0	216 (combination)	4.5
		412 to 450	12.0	240 (combination)	0	240 (combination)	5.0
		451 or above	14.0	264	0	264	2.5
				288	0	288	1.5
				312	0	312	2.0
				336	0	336	2.0
				384	8.8	384	0
				432	8.8	432	0

Table <A>

* In the case all connected indoor unit models are Case 1 or Case 2, do NOT add the refrigerant listed in table <A>. Instead, add the following amount of refrigerant.

Case 1: PLFY-EP06/18/36NEMU-E**

→ Add 0.67 kg per PLFY-EP06/18/36NEMU-E**.

Case 2: PEFY-P06/24/36NMAU-E**

→ Add 0.55 kg per PEFY-P06/24/36NMAU-E**.

* High-pressure pipe: Main high-pressure pipe between outdoor unit and BC controller

* Liquid pipe: Liquid pipe between BC controller and indoor unit or between main BC controller and sub BC controller

* When connecting the CMB-P**-NU-G1, CMB-P**-NU-GA1, CMB-P**-NU-HA1, CMB-P**-NU-GB1, or CMB-P**-NU-HB1 to a given system, do NOT add the refrigerant listed in table <A>. Instead, add the amount of refrigerant as indicated in the table below.

BC controller	Amount (kg/unit)	+	Total capacity of outdoor units		Amount (To be added for G1/GA1/HA1-type BC controller)	
G1/GA1-type	0		P72		3.0 kg	
HA1-type	2.0		P96		4.5 kg	
GB1/HB1-type	1.0		P120		4.5 kg	
			P144-P432		6.0 kg	

• When the piping length from the outdoor unit to the farthest indoor unit is longer than 30.5 m (100 ft)

Amount of additional charge (kg)	=	High-pressure pipe ø28.58 total length × 0.33 (kg/m)	+	High-pressure pipe ø22.2 total length × 0.21 (kg/m)	+	High-pressure pipe ø19.05 total length × 0.14 (kg/m)	+	High-puressure pipe ø15.88 total length × 0.1(kg/m)	+	Liquid pipe ø6.35 total length × 0.021 (kg/m)			
		Liquid pipe ø19.05 total length × 0.26 (kg/m)	+	Liquid pipe ø15.88 total length × 0.18 (kg/m)	+	Liquid pipe ø12.7 total length × 0.11 (kg/m)	+	Liquid pipe ø9.52 total length × 0.054 (kg/m)					
		Main or Sub BC controller	Amount (kg/unit)	Total capacity of connected indoor units		Amount (kg) (to be added for indoor unit)		Total capacity of outdoor units			Amount (kg) (to be added for outdoor unit)		
		J-type	1.5	27 or below	2.0	72	0						
		JA-type	3.0	28 to 54	2.5	96	0						
KA-type	4.7	55 to 126	3.0	120	0								
KB-type	0.4	127 to 144	3.5	144	0								
		145 to 180	4.5	168	0								
		181 to 234	5.0	192 (single)	4.4								
		235 to 273	6.0	216 (single)	4.4								
		274 to 307	8.0	240 (single)	4.4								
		308 to 342	9.0	192 (combination)	0								
		343 to 411	10.0	216 (combination)	0								
		412 to 450	12.0	240 (combination)	0								
		451 or above	14.0	264	0								
				288	0								
				312	0								
				336	0								
				384	5.0								
				432	5.0								

* When connecting PEFY-P06NMAU-E**, PEFY-P24NMAU-E**, or PEFY-P36NMAU-E**, add 0.55 kg [20 oz] of refrigerant per indoor unit.
 * When connecting PLFY-EP06NEMU-E**, PLFY-EP18NEMU-E**, or PLFY-EP36NEMU-E**, add 0.67 kg [24 oz] of refrigerant per indoor unit.
 * High-pressure pipe: Main high-pressure pipe between outdoor unit and BC controller
 * Liquid pipe: Liquid pipe between BC controller and indoor unit or between main BC controller and sub BC controller
 * When connecting the CMB-P**-NU-G1, CMB-P**-NU-GA1, CMB-P**-NU-HA1, CMB-P**-NU-GB1, or CMB-P**-NU-HB1 to a given system, add the amount of refrigerant as indicated in the table below.

BC controller	Amount (kg/unit)	+	Total capacity of outdoor units		Amount (To be added for G1/GA1/HA1-type BC controller)	
G1/GA1-type	0		P72		3.0 kg	
HA1-type	2.0		P96		4.5 kg	
GB1/HB1-type	1.0		P120		4.5 kg	
			P144-P432		6.0 kg	

Units "ft" and "oz" (In an R2 system)
 <Formula>

• When the piping length from the outdoor unit to the farthest indoor unit is 30.5 m (100 ft) or shorter

Amount of additional charge (oz)	=	High-pressure pipe ø1-1/8 total length × 3.88 (oz/ft)	+	High-pressure pipe ø7/8 total length × 2.48 (oz/ft)	+	High-pressure pipe ø3/4 total length × 1.73 (oz/ft)	+	High-pressure pipe ø5/8 total length × 1.19 (oz/ft)	+	Liquid pipe ø1/4 total length × 0.26 (oz/ft)			
		Liquid pipe ø3/4 total length × 3.13 (oz/ft)	+	Liquid pipe ø5/8 total length × 2.16 (oz/ft)	+	Liquid pipe ø1/2 total length × 1.30 (oz/ft)	+	Liquid pipe ø3/8 total length × 0.65 (oz/ft)					
		Main or Sub BC controller	Amount (oz/unit)	Total capacity of connected indoor units		Amount (oz) (to be added for indoor unit)		Total capacity of outdoor units			Amount (oz) (to be added for outdoor unit)		
		J-type	53	27 or below	71	72	0	72			53		
		JA-type	106	28 to 54	89	96	0	96			53		
KA-type	166	55 to 126	106	120	0	120	106						
KB-type	15	127 to 144	124	144	0	144	89						
		145 to 180	159	168	0	168	142						
		181 to 234	177	192 (single)	156	192 (single)	124						
		235 to 273	212	216 (single)	156	216 (single)	142						
		274 to 307	283	240 (single)	156	240 (single)	159						
		308 to 342	318	192 (combination)	0	192 (combination)	142						
		343 to 411	353	216 (combination)	0	216 (combination)	159						
		412 to 450	424	240 (combination)	0	240 (combination)	177						
		451 or above	494	264	0	264	89						
				288	0	288	53						
				312	0	312	71						
				336	0	336	71						
				384	311	384	0						
				432	311	432	0						

Table

* In the case all connected indoor unit models are Case 1 or Case 2, do NOT add the refrigerant listed in table . Instead, add the following amount of refrigerant.
 Case 1: PLFY-EP06/18/36NEMU-E**
 → Add 24 oz per PLFY-EP06/18/36NEMU-E**.
 Case 2: PEFY-P06/24/36NMAU-E**
 → Add 20 oz per PEFY-P06/24/36NMAU-E**.
 * High-pressure pipe: Main high-pressure pipe between outdoor unit and BC controller
 * Liquid pipe: Liquid pipe between BC controller and indoor unit or between main BC controller and sub BC controller

PURY-EP-T(S)NU-A, Y(S)NU-A

* When connecting the CMB-P**-NU-G1, CMB-P**-NU-GA1, CMB-P**-NU-HA1, CMB-P**-NU-GB1, or CMB-P**-NU-HB1 to a given system, do NOT add the refrigerant listed in table . Instead, add the amount of refrigerant as indicated in the table below.

BC controller	Amount (oz/unit)	+	Total capacity of outdoor units		Amount (To be added for G1/GA1/HA1-type BC controller)	
G1/GA1-type	0		P72		106 oz	
HA1-type	71		P96		159 oz	
GB1/HB1-type	36		P120		159 oz	
			P144-P432		212 oz	

• When the piping length from the outdoor unit to the farthest indoor unit is longer than 30.5 m (100 ft)

Amount of additional charge (oz)	=	High-pressure pipe ø1-1/8 total length × 3.54 (oz/ft)	+	High-pressure pipe ø7/8 total length × 2.26 (oz/ft)	+	High-pressure pipe ø3/4 total length × 1.51 (oz/ft)	+	High-pressure pipe ø5/8 total length × 1.08 (oz/ft)	
	+	Liquid pipe ø3/4 total length × 2.81 (oz/ft)	+	Liquid pipe ø5/8 total length × 1.94 (oz/ft)	+	Liquid pipe ø1/2 total length × 1.19 (oz/ft)	+	Liquid pipe ø3/8 total length × 0.59 (oz/ft)	+

+	Main or Sub BC controller	Amount (oz/unit)	+	Total capacity of connected indoor units	Amount (oz) (to be added for indoor unit)	+	Total capacity of outdoor units	Amount (oz) (to be added for outdoor unit)
	J-type	53		27 or below	71		72	0
	JA-type	106		28 to 54	89		96	0
	KA-type	166		55 to 126	106		120	0
	KB-type	15		127 to 144	124		144	0
		145 to 180	159	168	0			
		181 to 234	177	192 (single)	156			
		235 to 273	212	216 (single)	156			
		274 to 307	283	240 (single)	156			
		308 to 342	318	192 (combination)	0			
		343 to 411	353	216 (combination)	0			
		412 to 450	424	240 (combination)	0			
		451 or above	494	264	0			
				288	0			
				312	0			
				336	0			
				384	177			
				432	177			

- * When connecting PEFY-P06NMAU-E**, PEFY-P24NMAU-E**, or PEFY-P36NMAU-E**, add 0.55 kg [20 oz] of refrigerant per indoor unit.
- * When connecting PLFY-EP06NEMU-E**, PLFY-EP18NEMU-E**, or PLFY-EP36NEMU-E**, add 0.67 kg [24 oz] of refrigerant per indoor unit.
- * High-pressure pipe: Main high-pressure pipe between outdoor unit and BC controller
- * Liquid pipe: Liquid pipe between BC controller and indoor unit or between main BC controller and sub BC controller
- * When connecting the CMB-P**-NU-G1, CMB-P**-NU-GA1, CMB-P**-NU-HA1, CMB-P**-NU-GB1, or CMB-P**-NU-HB1 to a given system, add the amount of refrigerant as indicated in the table below.

BC controller	Amount (oz/unit)	+	Total capacity of outdoor units		Amount (To be added for G1/GA1/HA1-type BC controller)	
G1/GA1-type	0		P72		106 oz	
HA1-type	71		P96		159 oz	
GB1/HB1-type	36		P120		159 oz	
			P144-P432		212 oz	

■ Amount of factory charged refrigerant

Outdoor unit Model	Charged amount
EP72	5.2 kg [184 oz]
EP96	8.0 kg [283 oz]
EP120	
EP144	10.8 kg [381 oz]
EP168	
EP192	11.8 kg [417 oz]
EP216	
EP240	

■ Sample calculation

Units "m" and "kg"

Indoor	1: 18	A: ø22.2	40m	a: ø6.35	10m
	2: 96	B: ø9.52	10m	b: ø9.52	10m
	3: 06	C: ø12.7	20m	c: ø6.35	5m
	4: 06	D: ø9.52	5m	d: ø6.35	5m
	5: 48	E: ø9.52	5m	e: ø9.52	5m
	6: 36	F: ø9.52	5m	f: ø9.52	5m
	7: 30	G: ø19.05	3m	g: ø9.52	5m
	8: 18	H: ø19.05	1m	h: ø6.35	10m

Outdoor P240

Main BC controller CMB-P108NU-JA1
Sub BC controller CMB-P104NU-KB1 × 4

The total length of each liquid line as follows:
ø22.2: A = 40 m
ø19.05: G + H = 4 m
ø12.70: C = 20 m
ø9.52: B + D + E + F + b + e + f + g = 50 m
ø6.35: a + c + d + h = 30 m
<Calculation example>
Additional refrigerant charge
= 40 × 0.21 + 4 × 0.14 + 20 × 0.11 + 50 × 0.054
+ 30 × 0.021 + 3 + 0.4 × 4 + 6
= 25.1 (25.09)kg

Units "ft" and "oz"

Indoor	1: 18	A: ø7/8	131ft	a: ø1/4	32ft
	2: 96	B: ø3/8	32ft	b: ø3/8	32ft
	3: 06	C: ø1/2	65ft	c: ø1/4	16ft
	4: 06	D: ø3/8	16ft	d: ø1/4	16ft
	5: 48	E: ø3/8	16ft	e: ø3/8	16ft
	6: 36	F: ø3/8	16ft	f: ø3/8	16ft
	7: 30	G: ø3/4	9ft	g: ø3/8	16ft
	8: 18	H: ø3/4	3ft	h: ø1/4	32ft

Outdoor P240

Main BC controller CMB-P108NU-JA1
Sub BC controller CMB-P104NU-KB1 × 4

The total length of each liquid line as follows:
ø7/8: A = 131 ft
ø3/4: G + H = 12 ft
ø1/2: C = 65 ft
ø3/8: B + D + E + F + b + e + f + g = 160 ft
ø1/4: a + c + d + h = 96 ft
<Calculation example>
Additional refrigerant charge
= 131 × 2.26 + 12 × 1.51 + 65 × 1.19 + 160 × 0.59
+ 96 × 0.23 + 106 + 15 × 4 + 212
= 886.1 (886.01)oz

■ Limitation of the amount of refrigerant to be charged

The above calculation result of the amount of refrigerant to be charged must become below the value in the table below.

Total index of the outdoor units		EP72 T/YNU	EP96 T/YNU	EP120 T/YNU	EP144 T/YNU	EP168 T/YNU	EP192 T/YNU	EP216 T/YNU	EP240 T/YNU	EP192 T/YSNU	EP216 T/YSNU
Maximum refrigerant charge	Factory charged	5.2kg	8.0kg	8.0kg	10.8kg	10.8kg	11.8kg	11.8kg	11.8kg	16.0kg	16.0kg
	Charged on site	28.3kg	33.5kg	39.5kg	38.5kg	39.5kg	38.5kg	38.5kg	38.5kg	58.0kg	74.0kg
	Total for system	33.5kg	41.5kg	47.5kg	49.3kg	50.3kg	50.3kg	50.3kg	50.3kg	74.0kg	90.0kg
	Factory charged	11 lbs 7 oz	17 lbs 10 oz	17 lbs 10 oz	23 lbs 12 oz	23 lbs 12 oz	26 lbs 1 oz	26 lbs 1 oz	26 lbs 1 oz	35 lbs 5 oz	35 lbs 5 oz
	Charged on site	62 lbs 7 oz	73 lbs 14 oz	87 lbs 2 oz	84 lbs 15 oz	87 lbs 2 oz	84 lbs 15 oz	84 lbs 15 oz	84 lbs 15 oz	127 lbs 14 oz	163 lbs 3 oz
	Total for system	73 lbs 14 oz	91 lbs 8 oz	104 lbs 12 oz	108 lbs 12 oz	110 lbs 15 oz	110 lbs 15 oz	110 lbs 15 oz	110 lbs 15 oz	163 lbs 3 oz	198 lbs 7 oz

Total index of the outdoor units		EP240 T/YSNU	EP264 T/YSNU	EP288 T/YSNU	EP312 T/YSNU	EP336 T/YSNU	EP384 T/YSNU	EP432 T/YSNU
Maximum refrigerant charge	Factory charged	16.0kg	18.8kg	21.6kg	21.6kg	21.6kg	23.6kg	23.6kg
	Charged on site	74.0kg	71.2kg	68.4kg	68.4kg	68.4kg	54.4kg	54.4kg
	Total for system	90.0kg	90.0kg	90.0kg	90.0kg	90.0kg	78.0kg	78.0kg
	Factory charged	35 lbs 5 oz	41 lbs 8 oz	47 lbs 10 oz	47 lbs 10 oz	47 lbs 10 oz	52 lbs 1 oz	52 lbs 1 oz
	Charged on site	163 lbs 3 oz	157 lbs 0 oz	150 lbs 13 oz	150 lbs 13 oz	150 lbs 13 oz	119 lbs 15 oz	119 lbs 15 oz
	Total for system	198 lbs 7 oz	198 lbs 7 oz	198 lbs 7 oz	198 lbs 7 oz	198 lbs 7 oz	171 lbs 16 oz	171 lbs 16 oz

PUR-EP-T(S)NU-A, Y(S)NU-A

12-4. Compatibility

Outdoor/Heat source unit	BC controller	Compatibility
PURY-(E)P-T/Y(S)NU	J1 type	Compatible
PURY-(E)P-T/Y(S)NU	G1 type	Compatible
PURY-(E)P-T/Y(S)NU	G type	Compatible

Outdoor/Heat source unit	BC controller			Compatibility
	Main	Sub		
PURY-(E)P-T/Y(S)NU	JA1/KA1 type	GB1/HB1 type	GB1/HB1 type	Compatible
	JA1/KA1 type	KB1 type	GB1/HB1 type	Not compatible
	JA1/KA1 type	GB1/HB1 type	GB/HB type	Compatible
	JA1/KA1 type	GB/HB type	GB/HB type	Compatible
	JA1/KA1 type	KB1 type	GB/HB type	Not compatible
	JA1/KA1 type	GB1/HB1 type	-	Compatible
	JA1/KA1 type	GB/HB type	-	Compatible
	GA1/HA1 type	KB1 type	KB1 type	Compatible
	GA1/HA1 type	KB1 type	GB1/HB1 type	Not compatible
	GA1/HA1 type	KB1 type	GB/HB type	Not compatible
	GA1/HA1 type	KB1 type	-	Compatible
	GA/HA type	KB1 type	KB1 type	Compatible
	GA/HA type	KB1 type	GB1/HB1 type	Not compatible
	GA/HA type	KB1 type	GB/HB type	Not compatible
	GA/HA type	KB1 type	-	Compatible

Outdoor/Heat source unit	BC controller		Compatibility
	Main	Sub	
PURY-(E)P-T/Y(S)NU	JA1/KA1 type	KB1 type	Compatible(*)

*Up to 11 Sub BC controllers can be connected (KB1 type only).

GA(1)/HA(1)/GB(1)/HB(1) type and JA1/KA1/KB1 type can be mixed.

The only combination that is not available is mix of GB(1)/HB(1) type and KB1 type.

When mixing GA(1)/HA(1)/GB(1)/HB(1) type and JA1/KA1/KB1 type, specifications and restrictions are according to GA(1)/HA(1)/GB(1)/HB(1) type. (piping length, connectable number of Sub BC)

13-1. General requirements for installation

1. If possible, locate the unit to reduce the direct thermal radiation to the unit.
2. Consider the amount of noise the unit produces when choosing an installation location.
Valves and refrigerant flow on the outdoor/heat source unit may generate noise.
3. Avoid sites that may encounter strong winds.
4. Ensure the installation site can bear the weight of the unit.
5. Condensation should be moved away from the unit, particularly in heating mode.
6. Provide enough space for installation and service as shown in section 13-2. Spacing.
7. Avoid sites where acidic solutions or chemical sprays (such as sulfur sprays) are used frequently.
8. The unit should be provided from combustible gas, oil, steam, chemical gas like acidic solution, sulfur gas and so on.

13-2. Spacing

In case of single installation

(1) When all walls are within their height limits*.

[mm (in)]

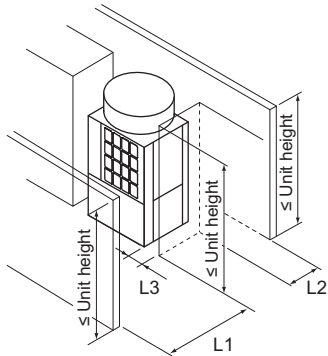

* Height limit

Front/Right/Left/Rear	Same height or lower than the overall height of the unit
-----------------------	--

	Required minimum distance [mm (in)]		
	L1 (Front)	L2 (Rear)	L3 (Right/Left)
When the distance behind the unit (L2) needs to be small	450 (17-3/4)	100 (3-15/16)	50 (2)
When the distance to the right or left (L3) needs to be small	450 (17-3/4)	300 (11-13/16)	15 (5/8)

(2) When one or more walls exceed their height limits*.

When the wall(s) at the front and/or the right/left exceed(s) their height limits

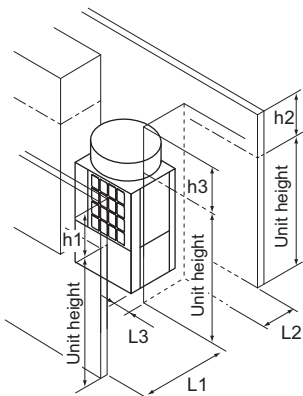

When the wall at the rear exceeds its height limit

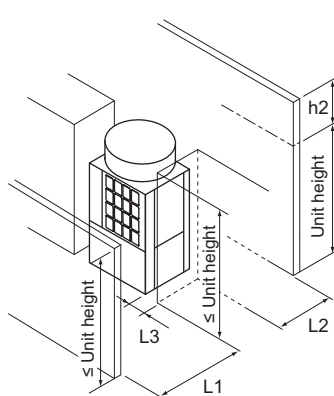

When all walls exceed their height limits

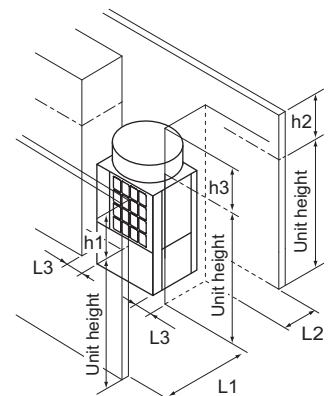

Add the dimension that exceeds the height limit (shown as "h1" through "h3" in the figures) to L1, L2, and L3 as shown in the table below.

	Required minimum distance [mm (in)]		
	L1 (Front)	L2 (Rear)	L3 (Right/Left)
When the distance behind the unit (L2) needs to be small	450 (17-3/4) + h1	100 (3-15/16) + h2	50 (2) + h3
When the distance to the right or left (L3) needs to be small	450 (17-3/4) + h1	300 (11-13/16) + h2	15 (5/8) + h3

(3) When there are overhead obstacles

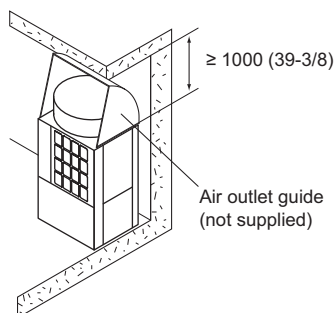
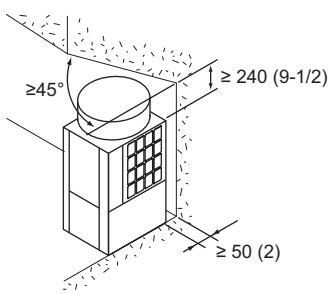

PURY-EP-T(S)NU-A, Y(S)NU-A

In case of collective installation and continuous installation

- When installing multiple units, make sure to take into consideration factors such as providing enough space for people to pass through, ample space between blocks of units, and sufficient space for airflow. (The areas marked with [A] in the figures below must be left open.)
- In the same way as with the single unit installation, add the dimension that exceeds the height limit (shown as "h1" through "h3" in the figures) to L1, L2, and L3 as shown in the tables below.
- If there are walls in the front and rear of the block of units, up to six units (three units for units EP168, EP192, EP216, and EP240) can be installed consecutively side by side, and a space of 1000 mm (39-3/8 in) or more must be left between each block of six units (three units for units EP168, EP192, EP216, and EP240).

(1) Side-by-side installation

When the distances between the units (L4) need to be small

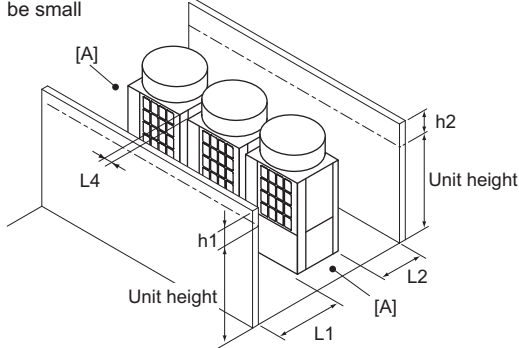

Required minimum distance [mm (in)]		
L1 (Front)	L2 (Rear)	L4 (Between)
450 (17-3/4) + h1	300 (11-13/16) + h2	30 (1-3/16)

When the distance behind the block of units (L2) needs [mm (in)] to be small

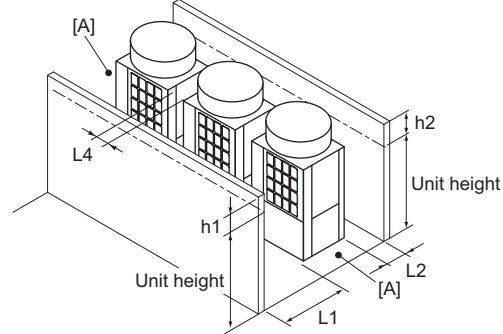

Required minimum distance [mm (in)]		
L1 (Front)	L2 (Rear)	L4 (Between)
450 (17-3/4) + h1	100 (3-15/16) + h2	100 (3-15/16)

(2) Face-to-face installation

When there are walls in the front and rear of the block of units

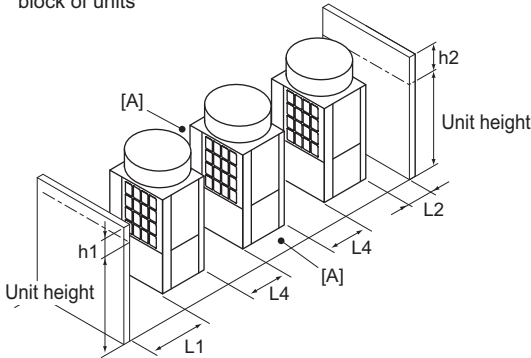

Required minimum distance [mm (in)]		
L1 (Front)	L2 (Rear)	L4 (Between)
450 (17-3/4) + h1	100 (3-15/16) + h2	450 (17-3/4)

When there is a wall on either the right or left side of the block of units

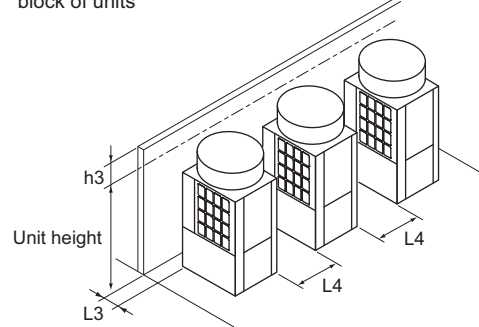

Required minimum distance [mm (in)]	
L3 (Right/Left)	L4 (Between)
15 (5/8) + h3	450 (17-3/4)

(3) Combination of face-to-face and side-by-side installations

When there are walls in the front and rear of the block of units

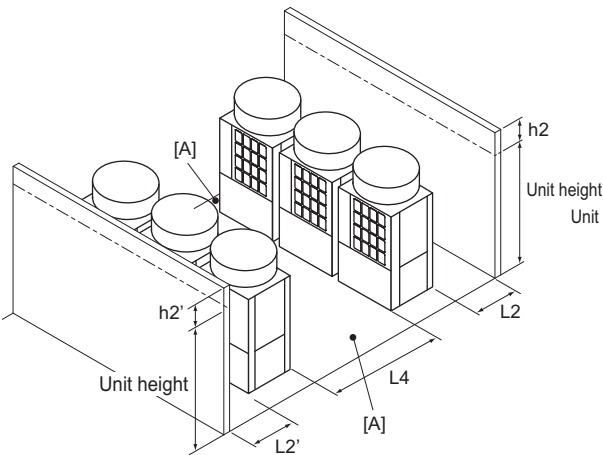

Required minimum distance [mm (in)]		
L2 (Rear)	L2' (Rear)	L4 (Between)
300 (11-13/16) + h2	300 (11-13/16) + h2'	900 (35-7/16)

When there are two walls in an L-shape

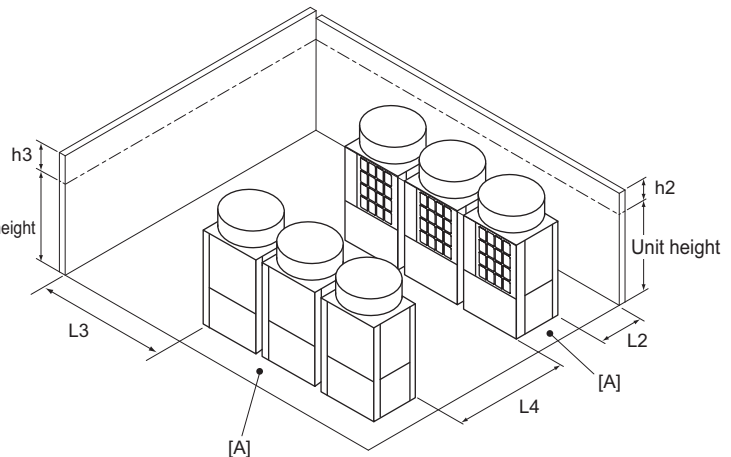

Required minimum distance [mm (in)]		
L2 (Rear)	L3 (Right/Left)	L4 (Between)
300 (11-13/16) + h2	1000 (39-3/8) + h3	900 (35-7/16)

[A]: Leave open in two directions.

13-3. Piping direction

13-3-1. Lifting method

- Always use two slings to lift up the unit. Each sling must be at least 8 m (26 ft) long and must be able to support the weight of the unit.
- Put protective pads between slings and the unit where the slings touch the unit at the base to protect the unit from being scratched.
- Put 50 mm (2 in) or thicker protective pads between slings and the unit where the slings touch the unit at the top of the unit to protect the unit from being scratched and to avoid contact with the slings and the fan guard.
- Make sure that the angles between slings at the top are less than 40 degrees

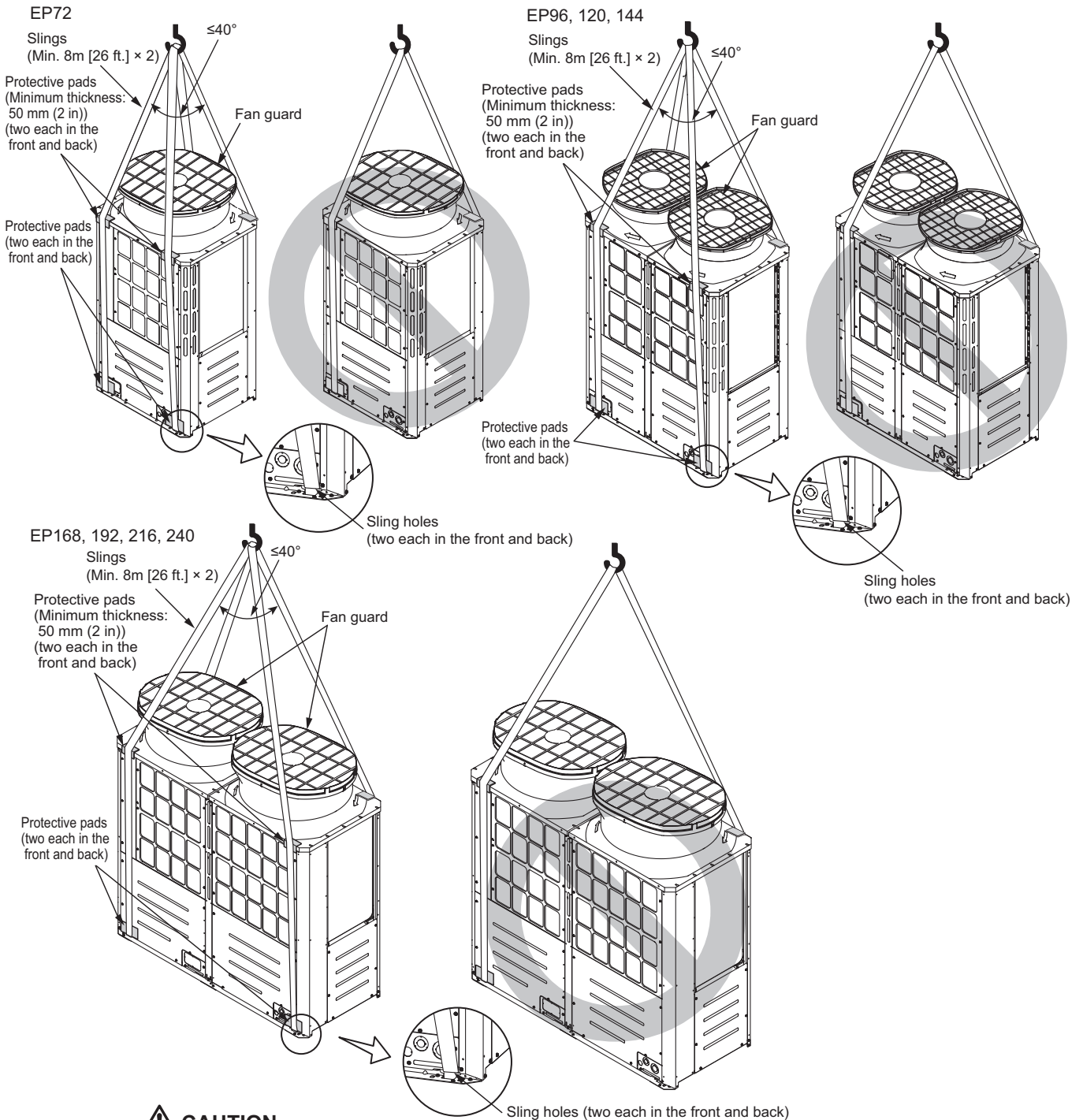

CAUTION

Exercise caution when transporting products.

- Products weighing more than 20 kg [45 LBS] should not be carried alone.
- Do not carry the product by the PPbands.
- To avoid the risk of injury, do not touch the heat exchanger fins.
- Plastic bags may pose a risk of choking hazard to children. Tear plastic bags into pieces before disposing of them.
- When lifting and transporting outdoor units with ropes, run the ropes through lifting hole at the unit base. Securely fix the unit so that the ropes will not slide off, and always lift the unit at four points to prevent the unit from falling.

PURY-EP-T(S)NU-A, Y(S)NU-A

13-3-2. Installation

- Secure the unit with anchor bolts as shown in the figure below so that the unit will not topple over with strong wind or during an earthquake.
- Install the unit on a durable base made of such materials as concrete or angle steel.
- Take appropriate anti-vibration measures (e.g., vibration damper pad, vibration isolation base) to keep vibrations and noise from being transmitted from the unit through walls and floors.
When installing a unit on a base, place an anti-vibration pad between the base and the unit.
- When using an anti-vibration rubber pad, install it so that the pad covers the entire width of the unit leg.
- All the bottom corners of the unit must still be supported by both the anti-vibration rubber pads and the base.
- Install the unit in such a way that the corner of the angle bracket at the base of the unit shown in the figure below is securely supported.
- Install the anchor bolt in such a way that the top end of the anchor bolt do not stick out more than 30 mm [1-3/16 in.].
- This unit is not designed to be anchored with post-installation-type anchor bolts, although by adding fixing brackets anchoring with such type of anchor bolts becomes possible.

(A) M10 anchor bolt* procured at the site

*Required specification for M10 anchor bolt: Tensile load of 5.6 kN or more to withstand the short-term load caused by earthquakes or strong winds

(B) (Incorrect installation) The corner section is not securely received.

(C) Fixing bracket for M12 hole-in anchor bolt* procured at the site (3 locations to fix with M5 self-tapping screws)

*Required specification for M12 hole-in anchor bolt:
Tensile load of 6.7 kN or more to withstand the short-term load caused by earthquakes or strong winds
Use the fixing bracket with sufficient strength.

(D) Anti-vibration rubber pad
(The pad needs to be large enough to cover the entire width of each unit leg.)

WARNING

Properly install the unit on a surface that can withstand the weight of the unit. Unit installed on an unstable surface may fall and cause injury.

WARNING

Take adequate measures against natural disasters including earthquakes and windstorms so that the unit will not fall or tip over. Consult your local specialist for safety measures to be taken.

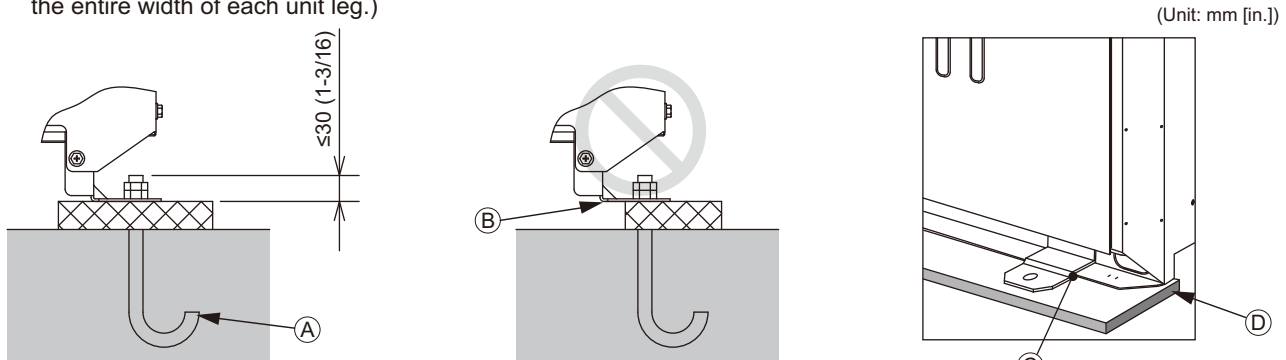

Take into consideration the durability of the base, water drainage route (Drain water is discharged from outdoor units during operation.), piping route, and wiring route when performing foundation work.

13-3-3. Anchor bolt positions

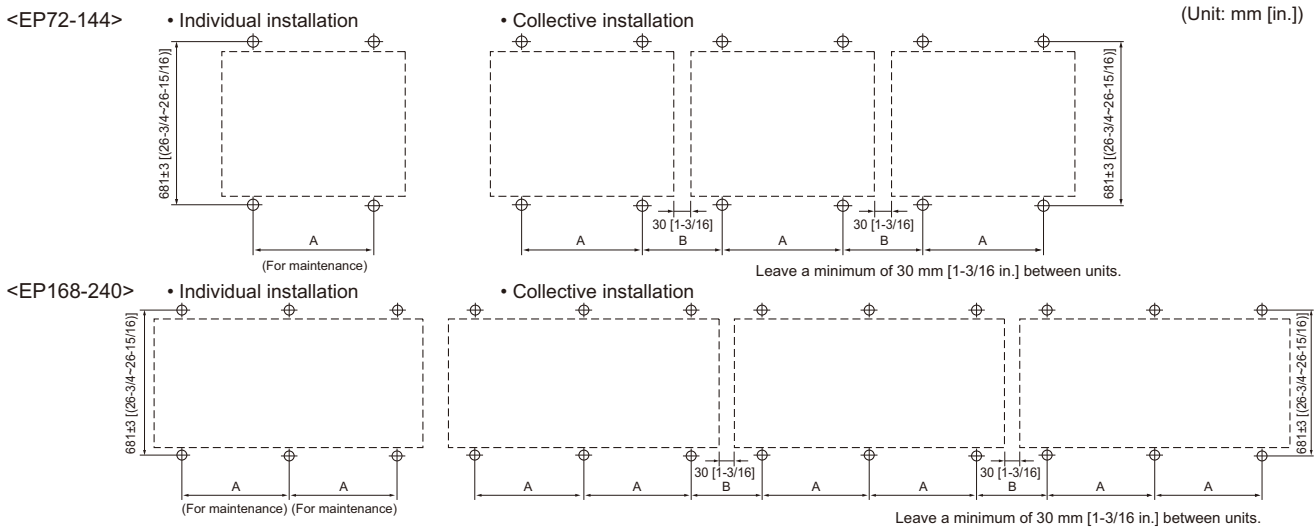

PURY	EP72	EP96, 120, 144	EP168, 192, 216, 240
A	760±2 [29-15/16(29-7/8-30)]	1060±2 [41-3/4(41-11/16-41-13/16)]	795±2 [31-5/16(31-1/4-31-7/16)]
B	190 [7-1/2]	210 [8-5/16]	190 [7-1/2]

13-3-4. Installation

When the pipes and/or cables are routed at the bottom of the unit, make sure that the through hole at the base of the unit does not get blocked with the installation base.
 When the pipes are routed at the bottom of the unit, the base should be at least 100 mm [3-15/16 in.] in height.

(Unit: mm[in.])

EP72

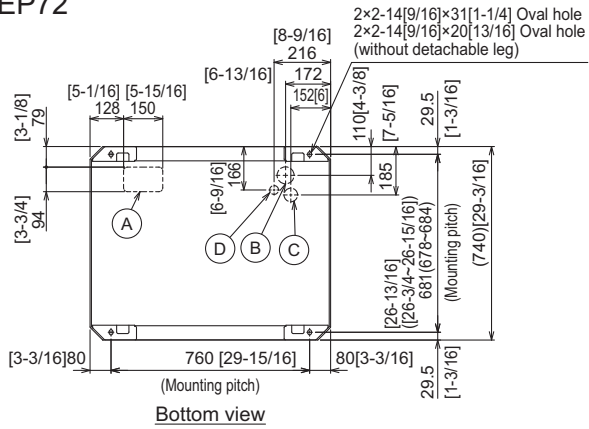

EP96, 120, 144

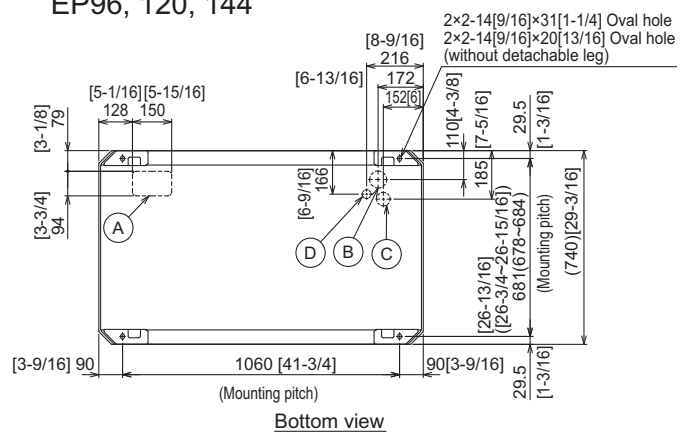

EP168, 192, 216, 240

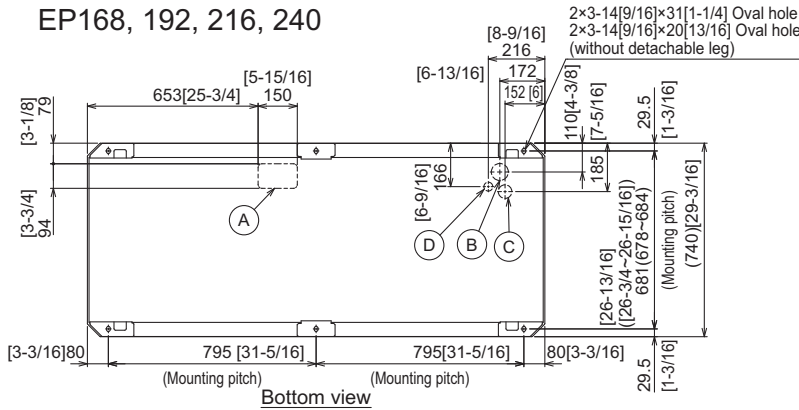

NO.	Usage	Specifications
(A)	For pipes	Bottom through hole 150 × 94 Knockout hole [5-15/16] [3-3/4]
(B)	For wires	Bottom through hole ø65 Knockout hole [2-9/16]
(C)		Bottom through hole ø52 Knockout hole [2-1/16]
(D)	For transmission cables	Bottom through hole ø34 Knockout hole [1-3/8]

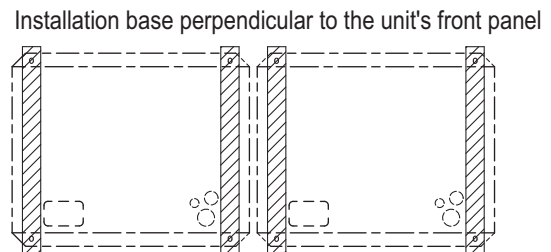
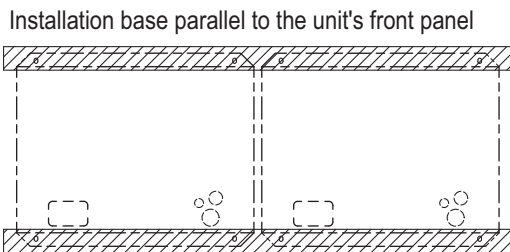

13-3-5. Refrigerant pipe routing

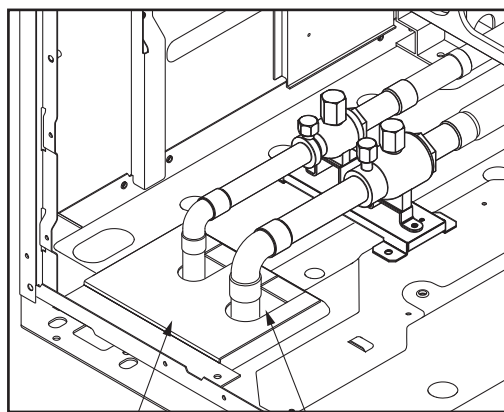

Example of closure materials (field supply) Fill the gap at the site

The gaps around the edges of through holes for pipes and wires on the unit allow water or mice to enter the unit and damage its parts. Close these gaps with filler plates.

This unit allows two types of pipe routing:

- Bottom piping
- Front piping

CAUTION

To prevent small animals, water and snow from entering the unit and damage its parts, close the gap around the edges of through holes for pipes and wires with filler plates.

PUR-EP-T(S)NU-A, Y(S)NU-A

13-3-6. Twinning on the outdoor unit side

- The pipe from multiple outdoor units must be installed so that oil will not accumulate in the pipe under certain conditions. Refer to the figures below for details.

* Small dots in the figures indicate branching points.

Ⓐ To a BC controller

- The pipe from the outdoor units must be inclined downward to the indoor unit side. In the figure on the right, because the pipe is inclined upward, the oil in the pipe accumulates when Unit 1 is in operation and Unit 2 is stopped.



- The distance between the unit bottom and the pipe (H) must be 0.2 m (7-7/8 in) or below. In the figure on the right, because the distance is more than 0.2 m (7-7/8 in), the oil accumulates in Unit 1 when Unit 2 is in operation and Unit 1 is stopped.

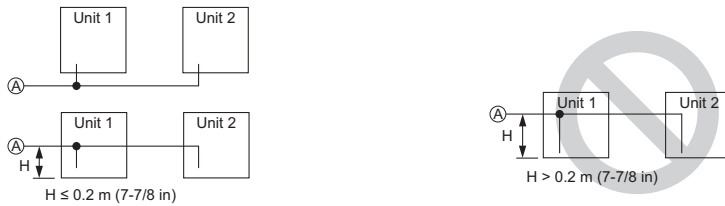

- The vertical separation between units (H) must be 0.1 m (3-15/16 in) or below. In the figure on the right, because the distance is more than 0.1 m (3-15/16 in), the oil accumulates in Unit 1 when Unit 2 is in operation and Unit 1 is stopped.



- The vertical separation between units (H) must be 0.1 m (3-15/16 in) or below. In the figure on the right, because the distance is more than 0.1 m (3-15/16 in), the oil accumulates in Unit 2 when Unit 1 is in operation and Unit 2 is stopped.



- Make sure that the inclination tolerance of the Twinning pipe is $\pm 15^\circ$ to the ground to avoid unit damage.

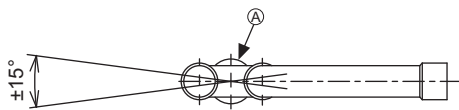

Ⓐ Twinning pipe

- If the length of the pipe between the branching point and the outdoor unit exceeds 2 m (6 ft), provide a trap within 2 m (6 ft) from the branching point. The trap must be at least 200 mm (7-7/8 in) in height. (high-pressure pipe only) If there is no trap, oil can accumulate inside the pipe, causing a shortage of oil and may damage the compressor.

* Small dots in the figures indicate branching points.



Ⓐ To indoor units
 Ⓑ Trap (high-pressure pipe only)
 Ⓒ High-pressure pipe

Caution:

- Do not install traps other than the ones between outdoor units described on a separate sheet to prevent oil backflow and compressor start-up failure.
- Do not install solenoid valves to prevent oil backflow and compressor start-up failure.
- Do not install a sight glass because it may show improper refrigerant flow.
- If a sight glass is installed, inexperienced technicians that use the glass may overcharge the refrigerant.
- Refrigerant pipes may expand or shrink due to temperature fluctuations of the refrigerant inside the pipes. When installing long straight pipes, provide traps to absorb the thermal expansions of the pipes.

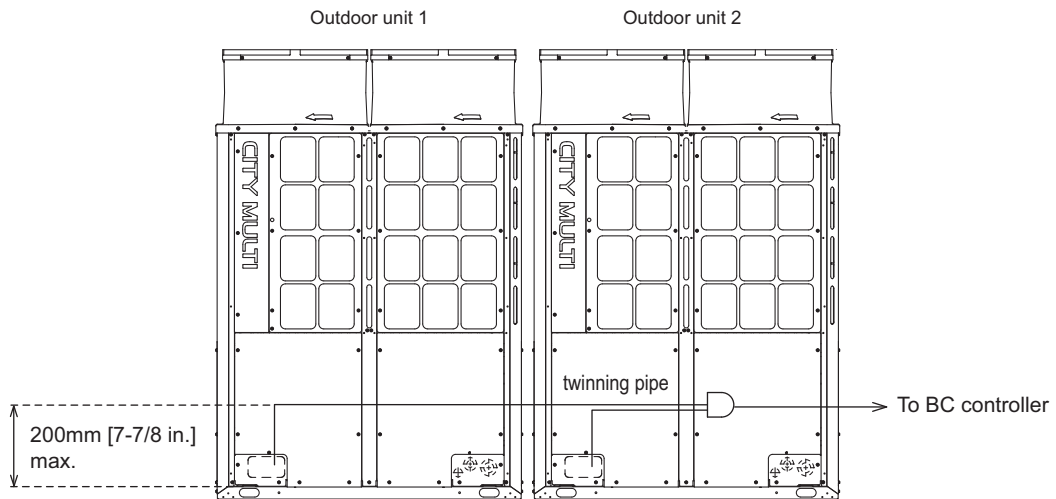

13-3-7. Twinning on the outdoor unit side

See the following drawing for connecting the pipes between the outdoor units.

<In case of 2units combination>

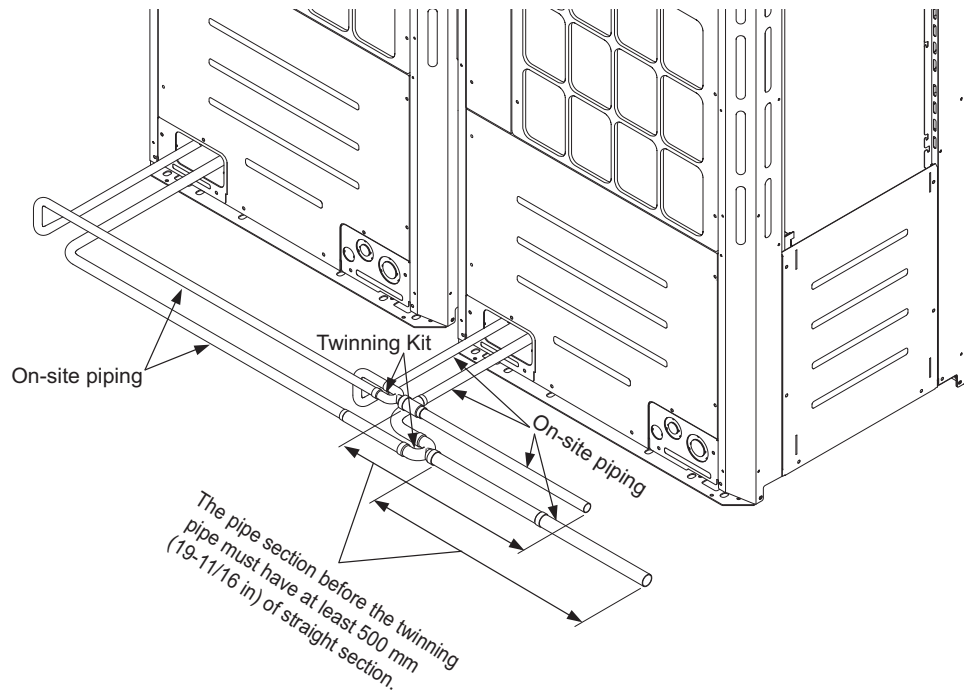

PURY-EP-T(S)NU-A, Y(S)NU-A

13-4. Weather countermeasure

In cold and/or snowy areas, sufficient countermeasures to wind and snow damages should be taken for operating unit in normal and good condition in winter time. Surround the units with snow nets or fences to protect them from snow. Even in the other areas, full consideration is required for installation of unit in order to prevent abnormal operations caused by wind or snow. **When rain and snow directly fall on unit in the case of air-conditioning operations in 10 or less degrees centigrade outdoor air (50 or less degrees fahrenheit outdoor air), mount inlet and outlet ducts on unit for assuring stable operations. It is recommended to install a duct to fully make use of the advantages of the panel heater.**

Countermeasure to snow and wind

Prevention the Outdoor unit from wind and snow damages in cold or snowy areas, snow hood shown below is recommended and helpful.

*Do not use a snow hood made of stainless steel, which may cause the unit to rust. If the use of a stainless snow hood is the only option, contact the sales office before installing it.

*When installing a snow hood, take pressure loss into consideration to prevent airflow from decreasing.

- Snow hood

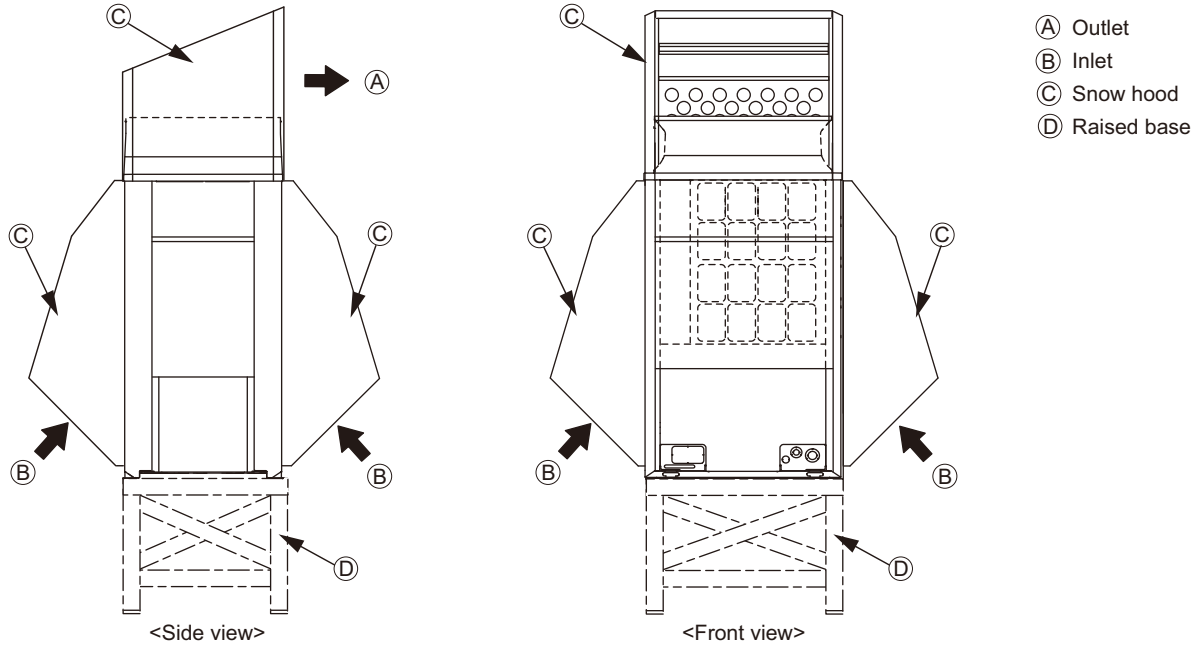

13-5. Countermeasure to wind

Referring to the figure shown below, take appropriate measures which will suit the actual situation of the place for installation. A unit installed alone is vulnerable to strong winds. Select the installation site carefully to minimize the effect of winds.

To install a unit in a place where the wind always blows from the same direction, install the unit so that the outlet faces away from the direction of the wind.

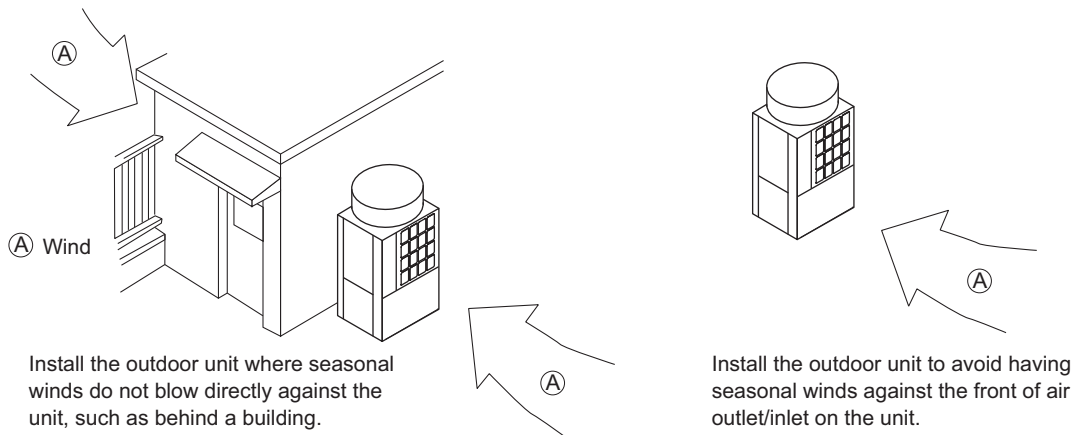

13-6. Precautions for installing a panel heater

If there is a risk that the drain water will freeze inside the outdoor unit, the installation of a panel heater is recommended.

When installing a panel heater, provide sufficient space for maintenance accordingly.

For details, refer to the installation manual for the panel heater.

Installation information

1. Installation information	2
1-1. General precautions	2
1-2. Precautions for Indoor unit and BC controller	4
1-3. Precautions for outdoor unit/heat source unit	5
1-4. Precautions for control-related items	6

* Refer to the enclosed Installation Manual for details on installation. Arrange to have an expert install the system correctly.

1-1. General precautions

1-1-1. Usage

- ♦The air-conditioning system described in this DATA BOOK is designed for human comfort.
- ♦This product is not designed to assist in the preservation of food, provide conditions to maintain plants or animals, or stabilize environments for the preservation of precision equipment or art objects. To prevent loss of quality, do not use the product for purposes other than those it is designed for.
- ♦To reduce the risk of water leakage and electric shock, do not use the product for air-conditioning vehicles or vessels.

1-1-2. Installation environment

- ♦Do not install any unit other than the dedicated unit in an area where the voltage changes significantly, large amounts of mineral oil (e.g., cutting oil) are present, cooking oil may splash, or a large quantity of steam can be generated, such as a kitchen.
- ♦Do not install the unit in acidic or alkaline environments.
- ♦Installation should not be performed in locations exposed to chlorine or other corrosive gases. Avoid installation near sewers.
- ♦To reduce the risk of fire, do not install the unit in an area where flammable gas may leak or flammable material is present.
- ♦This air-conditioning unit has a built-in microcomputer. The effects of noise should be taken into consideration when deciding on the installation position. It is recommended that the air-conditioning unit be installed in a position away from antennas or electronic devices.
- ♦Install the unit on a solid foundation in accordance with local safety measures against typhoons, wind gusts, and earthquakes to prevent the unit from being damaged, toppling over, or falling.

1-1-3. Backup system

- ♦In regions in which the malfunctioning of the air conditioner may have a critical effect, it is recommended to have two or more systems made up of single outdoor/heat source units and multiple indoor units.

1-1-4. Unit characteristics

- ♦The heat pump efficiency of the outdoor unit depends on the outdoor temperature. In heating mode, performance drops as the outside air temperature drops. In cold climates, performance can be poor. Warm air will continue to be trapped near the ceiling and the floor level will remain cold. In such cases, heat pumps require a supplemental heating system or air circulator. Before purchasing, consult your local distributor for assistance in selecting the unit and system.
- ♦When the outdoor temperature is low and the humidity is high, the heat exchanger on the outdoor/heat source unit side tends to collect frost, which reduces its heating performance. The Auto-defrost function will be activated in order to remove the frost, and the heating mode will temporarily stop for 3-10 minutes. Heating mode will automatically resume upon completion of the defrost process.
- ♦An air conditioner with a heat pump requires time to warm up the whole room after the heating operation begins, because the system circulates warm air in order to warm up the whole room.
- ♦Sound levels were obtained in an anechoic room. Sound levels during actual operation are usually higher than the simulated values due to ambient noise and echoes. Refer to the section on "SOUND LEVELS" in the DATA BOOK for the measurement location.
- ♦Depending on the operating conditions, the unit generates noise caused by valve actuation, refrigerant flow, and pressure changes even when operating normally. Try to avoid positioning the air conditioner in locations where quietness is required. With regard to the BC/HBC controller, it is recommended that the unit be installed in areas such as corridor ceilings, restrooms and plant rooms.
- ♦The total capacity of the connected indoor units can be greater than the capacity of the outdoor/heat source unit. However, when the connected indoor units operate simultaneously, each unit's capacity may become smaller than the rated capacity.
- ♦When the unit is started up for the first time within 12 hours after the power comes on, i.e. after a power failure, it performs initial startup operation (capacity control operation) to prevent damage to the compressor. The initial startup operation requires a maximum of 90 minutes to complete, depending on the operating load.

1-1-5. Related equipment

- ♦Use an earth leakage breaker (ELB) with medium sensitivity, and an activation speed of 0.1 second or less.
- ♦Consult your local distributor or a qualified technician when installing an earth leakage breaker.
- ♦If the unit is an inverter type, select an earth leakage breaker able to respond to high harmonic waves and surges.
- ♦Leakage current is generated not only through the air-conditioning unit but also through the power wires. The leakage current of the main power supply is therefore greater than the total leakage current of each unit. Take the capacity of the earth leakage breaker or leakage alarm into consideration when installing one at the main power supply. To measure the leakage current simply on site, use a measurement tool equipped with a filter, and clamp all the four power wires together. The leakage current measured on the ground wire may not be accurate because the leakage current from other systems may be included in the measurement value.
- ♦Do not install a phase-advancing capacitor on a unit connected to the same power system as an inverter-type unit and its related equipment.
- ♦If a large current flows due to the malfunctioning of the product or faulty wiring, both the earth leakage breaker on the product side and the upstream overcurrent breaker may trip almost at the same time. Separate the power system or coordinate all the breakers depending on the system's priority level.

1-1-6. Unit installation

- ♦Your local distributor or a qualified technician must read the Installation Manual that is provided with each unit carefully before performing installation work.
- ♦Consult your local distributor or a qualified technician when installing the unit. Improper installation by an unqualified person may result in water leakage, electric shock, or fire.
- ♦Ensure that there is enough space around each unit.

1-1-7. Optional accessories

- ♦Only use accessories recommended by Mitsubishi Electric. Consult your local distributor or a qualified technician when installing them. Improper installation by an unqualified person may result in water leakage, power leakage, system breakdown, or fire.
- ♦Some optional accessories may not be compatible for use with the air-conditioning unit or may not be suitable for the installation conditions. Check the compatibility when considering any accessories.
- ♦Note that some optional accessories may affect the air conditioner's external form, appearance, weight, operating sound, and other characteristics.

1-1-8. Operation/Maintenance

- ♦Read the Instruction Book that is provided with each unit carefully prior to use.
- ♦Maintenance or cleaning of each unit may be risky and require expertise. Read the Instruction Book to ensure safety. Consult your local distributor or a qualified technician when special expertise is required, such as when the indoor unit needs to be cleaned.

1-2. Precautions for Indoor unit and BC controller

1-2-1. Operating environment

- The refrigerant (R410A) used in the air conditioner is non-toxic and nonflammable. However, if the refrigerant leaks, the oxygen level may drop to harmful levels. If the air conditioner is installed in a small room, measures must be taken to prevent the refrigerant concentration from exceeding the safety limit even if the refrigerant leaks.
- If the units operate in cooling mode at a humidity above 80%, condensation may collect and drip from the indoor units.
- Regular checking and cleaning of the drain drainage paths, such as the drain pan or the drain pump, is recommended to prevent clogging. The neglect of a clogged drain pump may trigger the water-leakage protection function which stops operation of the entire system.

1-2-2. Unit characteristics

- The return air temperature display on the remote controller may differ from the displays on the other thermometers.
- The clock on the remote controller may be displayed with a time lag of approximately one minute every month.
- The temperature measured by the built-in temperature sensor on the remote controller may differ from the actual room temperature due to the effect of the wall temperature.
- Use the built-in thermostat on the remote controller or a separately-sold thermostat when indoor units installed on or in the ceiling operate the automatic cooling/heating switchover.
- The room temperature may rise drastically due to Thermo OFF in areas where the air-conditioning load is large, such as computer rooms.
- Be sure to use a regular filter. If an irregular filter is installed, the unit may not operate properly, and operating noise may increase.
- The room temperature may increase above the preset temperature in environments in which the heating or air-conditioning load is small.

1-2-3. Unit installation

- The insulation for the low-pressure pipe between the BC controller and the outdoor/heat source unit must be at least 20 mm (13/16 in.) thick. If the unit is installed on the top floor or in a high-temperature, high-humidity environment, thicker insulation may be necessary.
- Do not have any branching points on the downstream of the refrigerant pipe header.
- When a field-supplied external thermistor is installed or when a device for demand control is used, the unit may stop abnormally or damage may occur to the electromagnetic contactor. Consult your local distributor for details.
- When indoor units employ fresh air intake, install a filter in the duct (locally procured) to remove dust from the air.
- The 4-way Cassette Type units that have an outside air inlet can be connected to the duct, but need a booster fan to be installed at site. Refer to the chapter "Indoor Unit" for the available range for fresh air intake volume.
- Employing fresh air intake for the indoor unit may increase the sound pressure level.
- Do not install the unit above the cooking or food processing area.

1-2-4. Noise level (Sound pressure level)

- The sound pressure level is a value measured in an anechoic room in accordance with the conventional method in JIS standard. The sound pressure level actually measured at the installation site is usually higher than the value indicated in this DATA BOOK due to the influence of ambient noise and echoes.

1-3. Precautions for outdoor unit/heat source unit

1-3-1. Installation environment

- ♦The outdoor unit with the salt-resistant specification is recommended for use in an area in which it will be exposed to salt air.
 - ♦Even when the unit with the salt-resistant specification is used, it is not completely protected against corrosion. Be sure to follow the directions or precautions described in the Instruction Book and Installation Manual for installation and maintenance. The salt-resistant specification is referred to in the guidelines published by JRAIA (JRA9002).
 - ♦Install the unit in an area where the flow of discharge air is not obstructed. If the flow of discharge air is obstructed, short-cycling of discharge air may occur.
 - ♦Provide proper drainage around the base of the units; condensation may collect and drip from outdoor units. Provide water-proofing protection to the floor when installing the unit on the rooftop.
 - ♦In regions where snowfall can be expected, install the unit so that the outlet faces away from the direction of the wind, and install a snow guard to protect the unit from snow. Install the unit on a base approximately 50 cm (19-11/16 in.) higher than the expected snowfall. Close the openings for pipes and wiring, because the ingress of water and small animals may cause equipment damage. If a SUS snow guard is used, refer to the Installation Manual that comes with the snow guard and be careful with the installation to avoid the risk of corrosion.
 - ♦When the unit is expected to operate continuously for a long period of time at outside air temperatures of below 0°C (32°F), take appropriate measures, such as the use of a unit base heater, to prevent ice forming on the unit base. (Not applicable to the PUMY-Series)
 - ♦Install the snow guard so that the outlet/inlet faces away from the direction of the wind.
 - ♦When approximately 50 cm (19-11/16 in.) or more of snow accumulates on the snow guard, remove the snow from the guard. Install a roof that is strong enough to withstand loads caused by snow in areas where snow accumulates.
 - ♦Provide proper protection around the outdoor units in places such as schools to avoid the risk of injury.
 - ♦A cooling tower and heat source water circuit should be a closed circuit so that water is not exposed to the atmosphere. When a tank is installed to ensure that the circuit has enough water, minimize the contact with outside air to ensure that the oxygen dissolved in the water is 1 mg/L or less.
 - ♦Install a strainer (50 mesh or more recommended) on the water pipe inlet on the heat source unit.
 - ♦Interlock the heat source unit and water circuit pump.
 - ♦Note the following to prevent the freezing and bursting of pipes when the heat source unit is installed in an area where the ambient temperature can be 0°C (32°F) or below.
 - ♦Keep the water circulating to prevent it from freezing when the ambient temperature is 0°C (32°F) or below.
 - ♦Before a long period of non-use, be sure to purge the water from the unit.
 - ♦The salt-resistant unit is resistant to salt corrosion, but not salt-proof.
- Please note the following when installing and maintaining outdoor units in a marine environment.
1. Install the salt-resistant unit in an area in which it is not directly exposed to sea breezes, and minimize exposure to salt water mist.
 2. Avoid installing a sun shade over the outdoor unit, so that rain will wash away salt deposits off the unit.
 3. Install the unit horizontally to ensure proper water drainage from the base of the unit. Accumulation of water in the base of the outdoor unit will significantly accelerate corrosion.
 4. Periodically wash salt deposits off the unit, especially when the unit is installed in a coastal area.
 5. Repair all noticeable scratches after installation and during maintenance.
 6. Periodically check the unit, and apply an anti-rust agent and replace corroded parts as necessary.

1-3-2. Circulating water

- ♦Regularly check the quality of the water in the heat source unit, following the guidelines published by JRAIA (JRA-GL02-1994).
- ♦A cooling tower and heat source water circuit should be a closed circuit so that water is not exposed to the atmosphere. When a tank is installed to ensure that the circuit has enough water, minimize the contact with outside air to ensure that the oxygen dissolved in the water is 1 mg/L or less.

1-3-3. Unit characteristics

- ♦When the Thermo ON and OFF is frequently repeated on the indoor unit, the operating status of outdoor/heat source units may become unstable.

1-3-4. Related equipment

- ♦Provide grounding in accordance with the local regulations.

1-3-5. Noise level (Sound pressure level)

- ♦The sound pressure level is a value measured in an anechoic room in accordance with the conventional method in JIS standard. The sound pressure level actually measured at the installation site is usually higher than the value indicated in this DATA BOOK due to the influence of ambient noise and echoes.
- ♦Valve operation noise and refrigerant flow noise may occur from inside the outdoor unit/heat-source unit.

1-4. Precautions for control-related items

1-4-1. Product specification

- ♦To introduce the MELANS system, a consultation with us is required in advance. Especially to introduce the electricity charge-apportioning function or energy save function, further detailed consultation is required. Consult your local distributor for details.
- ♦Billing calculation for AE-200A/AE-50A/EW-50A, or the billing calculation unit is unique and based on our original method. (Backup operation is included.) It is not based on the metering method, and do not use it for official business purposes. It is not the method that the amount of electric power consumption (input) by air conditioner is calculated. Note that the electric power consumption by air conditioner is apportioned by using the ratio corresponding to the operation status (output) for each air conditioner (indoor unit) in this method.
- ♦In the apportioned billing function for AE-200A/AE-50A and EW-50A, separate watt-hour meters should be used for A-control units, K-control units, and CITY MULTI packaged air conditioners. It is recommended that an individual watt-hour meter should be used for large-capacity indoor units (with two or more addresses).
- ♦When using the peak cut function on the AE-200A/AE-50A or EW-50A, note that the control is performed once every minute and it takes time to obtain the effect of the control. Take appropriate measures such as lowering the criterion value. Power consumption may exceed the limits if the AE-200A/AE-50A or EW-50A malfunctions or stops. Provide a back-up remedy as necessary.
- ♦The controllers cannot operate while the indoor unit is OFF. (No error)
Turn ON the power to the indoor unit when operating the controllers.
- ♦When using the interlocked control function on the AE-200A/AE-50A/EW-50A/PAC-YG66DCA or PAC-YG63MCA, do not use the control for fire prevention or security. (This function should never be used in a way that would put people's lives at risk.) Employ any methods or circuits that allow ON/OFF operation using an external switch in case of failure.

1-4-2. Installation environment

- ♦Surge protection may be required for the transmission line in areas where lightning strikes occur frequently.
- ♦The receiver for a wireless remote controller may not work properly due to the effect of general lighting. Leave a space of at least 1 m between the general lighting and the receiver.
- ♦When the auto-elevating panel is used and the system is operated using a wired remote controller, install the wired remote controller in a place where all the air conditioners being controlled (at least the bottom part of them) can be seen from the wired remote controller. If not, the descending panel may cause damage or injury; be sure to use a wireless remote controller designed for use with the elevating panel (sold separately).
- ♦Install the wired remote controller (switch box) in a place where the following conditions are met.
 - ♦Where the installation surface is flat
 - ♦Where the remote controller can detect an accurate room temperature
The temperature sensors that detect the room temperature are installed both in the remote controller and in the indoor unit.
When the room temperature is detected using the sensor in the remote controller, the main remote controller is used to detect the room temperature. In this case, follow the instructions below.
 - ♦ Install the controller in a place where it is not affected by a heat source.
(If the remote controller faces direct sunlight or the direction of the supply air flow, the remote controller cannot detect the accurate room temperature.)
 - ♦ Install the controller in a place where the average room temperature can be detected.
 - ♦ Install the controller in a place where no other wires are present around the temperature sensor.
(If other wires are present, the remote controller cannot detect an accurate room temperature.)
- ♦To prevent unauthorized access, always use a security device such as a VPN router when connecting the AE-200A/AE-50A or EW-50A to the Internet.

CAUTION FOR REFRIGERANT LEAKAGE

1. Caution for refrigerant leakage	Ub-1-2
1-1. Refrigerant property	Ub-1-2
1-2. Confirm the Critical concentration and take countermeasure	Ub-1-2

1. Caution for refrigerant leakage

The installer and/or air conditioning system specialist shall secure safety against refrigerant leakage according to local regulations or standards. The following standard may be applicable if no local regulation or standard is available.

1-1. Refrigerant property

R410A refrigerant is harmless and incombustible. The R410A is heavier than the indoor air in density. Leakage of the refrigerant in a room has possibility to lead to a hypoxia situation. Therefore, the critical concentration specified below shall not be exceeded even if the leakage happens.

• Critical concentration

Critical concentration hereby is the refrigerant concentration in which no human body would be hurt if immediate measures can be taken when refrigerant leakage happens.

Critical concentration of R410A: 0.44kg/m³
(The weight of refrigeration gas per 1 m³ air conditioning space.);

* The Critical concentration is subject to ISO5149, EN378-1.

For the CITY MULTI system, the concentration of refrigerant leaked should not have a chance to exceed the critical concentration in any situation.

1-2. Confirm the Critical concentration and take countermeasure

The maximum refrigerant leakage concentration (Rmax) is defined as the result of the possible maximum refrigerant weight (Wmax) leaked into a room divided by its room capacity (V). It is referable to Fig.1-1. The refrigerant of Outdoor/Heat source unit here includes its original charge and additional charge at the site.

The additional charge is calculated according to the refrigerant charging calculation of each kind of Outdoor/Heat source unit, and shall not be over charged at the site. Procedure 1-2-1~3 tells how to confirm maximum refrigerant leakage concentration (Rmax) and how to take countermeasures against a possible leakage.

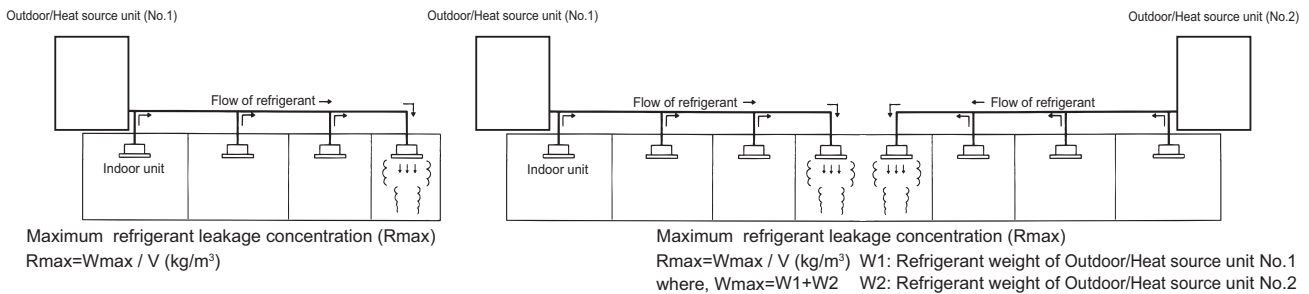

Fig. 1-1 The maximum refrigerant leakage concentration

1-2-1. Find the room capacity (V),

If a room having total opening area more than 0.15% of the floor area at a low position with another room/space, the two rooms/space are considered as one. The total space shall be added up.

1-2-2. Find the possible maximum leakage (Wmax) in the room. If a room has Indoor unit(s) from more than 1 Outdoor/Heat source unit, add up the refrigerant of the Outdoor/Heat source units.

1-2-3. Divide (Wmax) by (V) to get the maximum refrigerant leakage concentration (Rmax).

1-2-4. Find if there is any room in which the maximum refrigerant leakage concentration (Rmax) is over 0.44kg/m³.

If no, then the CITY MULTI is safe against refrigerant leakage.

If yes, following countermeasure is recommended to do at site.

Countermeasure 1: Let-out (making V bigger)

Design an opening of more than 0.15% of the floor area at a low position of the wall to let out the refrigerant whenever leaked. e.g. make the upper and lower seams of door big enough.

Countermeasure 2: Smaller total charge (making Wmax smaller)

e.g. Avoid connecting more than 1 Outdoor/Heat source unit to one room.
 e.g. Using smaller model size but more Outdoor/Heat source units.
 e.g. Shorten the refrigerant piping as much as possible.

Countermeasure 3: Fresh air in from the ceiling (Ventilation)

As the density of the refrigerant is bigger than that of the air. Fresh air supply from the ceiling is better than air exhausting from the ceiling. Fresh air supply solution refers to Fig. 1-2~4.

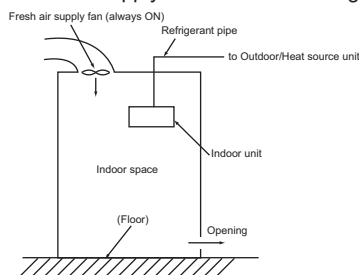

Fig. 1-2. Fresh air supply always ON

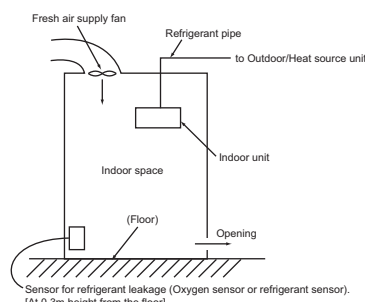

Fig. 1-3. Fresh air supply upon sensor action

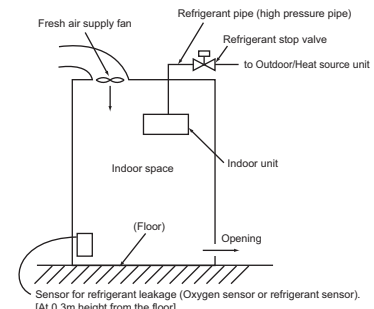

Fig. 1-4. Fresh air supply and refrigerant shut-off upon sensor action

Note 1. Countermeasure 3 should be done in a proper way in which the fresh air supply shall be on whenever the leakage happens.

Note 2. In principle, MITSUBISHI ELECTRIC requires proper piping design, installation and air-tight testing after installation to avoid leakage happening.

In the area should earthquake happen, anti-vibration measures should be fully considered.

The piping should consider the extension due to the temperature variation.

⚠ Warning

- Do not use refrigerant other than the type indicated in the manuals provided with the unit and on the nameplate.
 - Doing so may cause the unit or pipes to burst, or result in explosion or fire during use, repair, or at the time of disposal of the unit.
 - It may also be in violation of applicable laws.
 - MITSUBISHI ELECTRIC CORPORATION cannot be held responsible for malfunctions or accidents resulting from the use of the wrong type of refrigerant.
- Our air conditioning equipment and heat pumps contain a fluorinated greenhouse gas, R410A.

MITSUBISHI ELECTRIC CORPORATION

www.MitsubishiElectric.com