

Technical & Service Manual R32

[Model Name]
WUZ-SA24NMZ
WUZ-SA36NMZ
WUZ-SA48NMZ

[Service Reference]
WUZ-SA24NMZ-U1
WUZ-SA36NMZ-U1
WUZ-SA48NMZ-U1

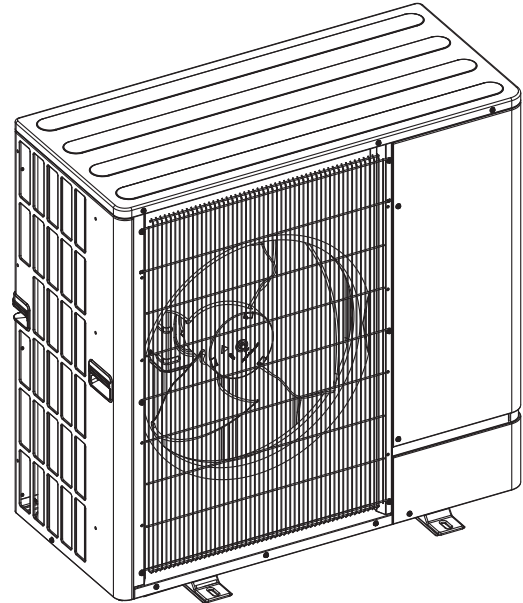

Contents

Service manual

1. REFERENCE MANUAL	2
2. SAFETY PRECAUTION	3
3. SPECIFICATIONS	10
4. DATA	11
5. OUTLINES AND DIMENSIONS	13
6. WIRING DIAGRAM	14
7. WIRING SPECIFICATIONS	16
8. REFRIGERANT SYSTEM DIAGRAM	17
9. TROUBLESHOOTING	19
10. MONITORING THE OPERATION DATA BY THE REMOTE CONTROLLER	60
11. DISASSEMBLY PROCEDURE	65

Technical data

T1. INTRODUCTION	72
T2. MAXIMUM OUTLET WATER TEMPERATURE	72
T3. AVAILABLE WATER FLOW RANGE	73
T4. PERFORMANCE DATA	75
T5. PERFORMANCE CHART	79
T6. CAPACITY DROP BY PIPE LENGTH	82
T7. NOISE CRITERION CURVE	83
T8. REFRIGERANT CIRCUIT DIAGRAM	83
T9. OPTIONAL PARTS	83

**INDOOR UNIT SERVICE MANUAL
1-1. FOR AIR TO WATER SYSTEM**

Model name	Service ref.	Service manual No.
ERSF-NM6E	ERSF-NM6E-U1	OCH892 OCB892

2-1. ALWAYS OBSERVE FOR SAFETY

Before obtaining access to terminal, all supply circuits must be disconnected.

Preparation before the repair service.

- Prepare the proper tools.
- Prepare the proper protectors.
- Provide adequate ventilation.
- After stopping the operation of the heat pump units, turn off the power-supply breaker.
- Discharge the condenser before the work involving the electric parts.

Precautions during the repair service.

- Do not perform the work involving the electric parts with wet hands.
- Do not pour water into the electric parts.
- Do not touch the refrigerant.
- Do not touch the hot or cold areas in the refrigerating cycle.
- When the repair or the inspection of the circuit needs to be done without turning off the power, exercise great caution not to touch the live parts.

2-2. CAUTIONS RELATED TO NEW REFRIGERANT

Cautions for units utilizing refrigerant R32

Use new refrigerant pipes.

In the case of using the existing pipes for R22, be careful with the following:

- Be sure to clean the pipes and make sure that the insides of the pipes are clean.
- Change flare nut to the one provided with this product. Use a newly flared pipe.
- Avoid using thin pipes.

Make sure that the inside and outside of refrigerant piping is clean and it has no contaminants such as sulfur, oxides, dirt, shaving particles, etc., which are hazard to refrigerant cycle. In addition, use pipes with specified thickness.

Contamination inside refrigerant piping can cause deterioration of refrigerant oil, etc.

Store the piping indoors, and both ends of the piping sealed until just before brazing. (Leave elbow joints, etc. in their packaging.)

If dirt, dust or moisture enters into refrigerant cycle, that can cause deterioration of refrigerant oil or malfunction of compressor.

The refrigerant oil applied to flare and flange connections must be ester oil, ether oil or alkylbenzene oil in a small amount.

If large amount of mineral oil enters, that can cause deterioration of refrigerant oil, etc.

Do not use refrigerant other than R32.

If other refrigerant (R22, etc.) is used, chlorine in refrigerant can cause deterioration of refrigerant oil, etc.

Use a vacuum pump with a reverse flow check valve.

Vacuum pump oil may flow back into refrigerant cycle and that can cause deterioration of refrigerant oil, etc.

Use the following tools specifically designed for use with R32 refrigerant.

The following tools are necessary to use R32 refrigerant.

Tools for R32	
Gauge manifold	Flare tool
Charge hose	Size adjustment gauge
Gas leak detector	Vacuum pump adaptor
Torque wrench	Electronic refrigerant charging scale

Handle tools with care.

If dirt, dust or moisture enters into refrigerant cycle, that can cause deterioration of refrigerant oil or malfunction of compressor.

Use the specified refrigerant only.

Never use any refrigerant other than that specified. Doing so may cause a burst, an explosion, or fire when the unit is being used, serviced, or disposed of. Correct refrigerant is specified in the manuals and on the spec labels provided with our products. We will not be held responsible for mechanical failure, system malfunction, unit breakdown or accidents caused by failure to follow the instructions.

Ventilate the room if refrigerant leaks during operation. If refrigerant comes into contact with a flame, poisonous gases will be released.

[1] WARNING for service

- (1) Do not alter the unit.
- (2) For installation and relocation work, follow the instructions in the Installation Manual and use tools and pipe components specifically made for use with refrigerant specified in the outdoor unit installation manual.
- (3) Ask a dealer or an authorized technician to install, relocate and repair the unit.
For appliances not accessible to the general public.
- (4) Refrigerant pipes connection shall be accessible for maintenance purposes.
- (5) If the heat pump unit is installed in a small room or closed room, measures must be taken to prevent the refrigerant concentration in the room from exceeding the safety limit in the event of refrigerant leakage. Should the refrigerant leak and cause the concentration limit to be exceeded, hazards due to lack of oxygen in the room may result.
- (6) Keep gas-burning appliances, electric heaters, and other fire sources (ignition sources) away from the location where installation, repair, and other heat pump unit work will be performed.
If refrigerant comes into contact with a flame, poisonous gases will be released.
- (7) When installing or relocating, or servicing the heat pump unit, use only the specified refrigerant (R32) to charge the refrigerant lines.
Do not mix it with any other refrigerant and do not allow air to remain in the lines.
If air is mixed with the refrigerant, then it can be the cause of abnormal high pressure in the refrigerant line, and may result in an explosion and other hazards.
- (8) After installation has been completed, check for refrigerant leaks. If refrigerant leaks into the room and comes into contact with the flame of a heater or portable cooking range, poisonous gases will be released.
- (9) Do not use low temperature solder alloy in the case of brazing the refrigerant pipes.
- (10) When performing brazing work, be sure to ventilate the room sufficiently. Make sure that there are no hazardous or flammable materials nearby.
When performing the work in a closed room, small room, or similar location, make sure that there are no refrigerant leaks before performing the work.
If refrigerant leaks and accumulates, it may ignite or poisonous gases may be released.
- (11) Do not install the unit in places where refrigerant may build-up or places with poor ventilation such as a semi-basement or a sunken place in outdoor: Refrigerant is heavier than air, and inclined to fall away from the leak source.
- (12) Do not use means to accelerate the defrosting process or to clean, other than those recommended by the manufacturer.
- (13) The appliance shall be stored in a room without continuously operating ignition sources (for example: open flames, an operating gas appliance or an operating electric heater).
- (14) Do not pierce or burn.
- (15) Be aware that refrigerants may not contain an odor.
- (16) Pipe-work shall be protected from physical damage.
- (17) The installation of pipe-work shall be kept to a minimum.
- (18) Compliance with national gas regulations shall be observed.
- (19) Keep any required ventilation openings clear of obstruction.
- (20) Servicing shall be performed only as recommended by the manufacturer.
- (21) The appliance shall be stored in a well-ventilated area where the room size corresponds to the room area as specified for operation.
- (22) Maintenance, service and repair operations shall be performed by authorized technician with required qualification.
- (23) Be sure to have appropriate ventilation in order to prevent ignition. Furthermore, be sure to carry out fire prevention measures that there are no dangerous or flammable objects in the surrounding area.

[2] Cautions for service

- (1) Perform service after recovering the refrigerant left in unit completely.
- (2) Do not release refrigerant in the air.
- (3) After completing service, charge the cycle with specified amount of refrigerant.
- (4) When performing service, install a filter drier simultaneously.

Be sure to use a filter drier for new refrigerant.

[3] Additional refrigerant charge

When charging directly from cylinder

R32 is a single refrigerant and its composition does not change. Therefore, both liquid charging and gas charging are possible. Liquid charging of refrigerant all at once from the low pressure side may cause the compressor malfunction. Accordingly, make sure that charging is gradual.

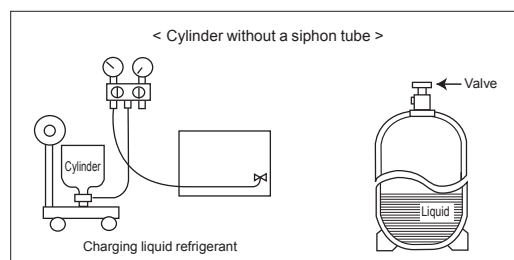
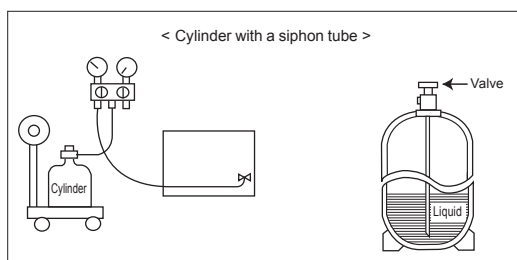

[4] Cautions for unit using R32 refrigerant

Basic work procedures are the same as those for conventional units using refrigerant R410A. However, pay careful attention to the following points.

(1) Information on servicing

(1-1) Checks on the Area

Prior to beginning work on systems containing flammable refrigerants, safety checks are necessary to ensure that the risk of ignition is minimized.

For repair to the refrigerating systems, (1-3) to (1-7) shall be completed prior to conducting work on the systems.

(1-2) Work Procedure

Work shall be undertaken under a controlled procedure so as to minimize the risk of a flammable gas or vapor being present while the work is being performed.

(1-3) General Work Area

All maintenance staff and others working in the local area shall be instructed on the nature of work being carried out.

Work in confined spaces shall be avoided. The area around the workspace shall be sectioned off. Ensure that the conditions within the area have been made safe by control of flammable material.

(1-4) Checking for Presence of Refrigerant

The area shall be checked with an appropriate refrigerant detector prior to and during work, to ensure the technician is aware of potentially toxic or flammable atmospheres. Ensure that the leak detection equipment being used is suitable for use with all applicable refrigerants, i.e. non-sparking, adequately sealed or intrinsically safe.

(1-5) Presence of Fire Extinguisher

If any hot work is to be conducted on the refrigeration equipment or any associated parts, appropriate fire extinguishing equipment shall be available to hand.

Have a dry powder or CO₂ fire extinguisher adjacent to the charging area.

(1-6) No Ignition Sources

No person carrying out work in relation to a refrigeration system which involves exposing any pipe work shall use any sources of ignition in such a manner that it may lead to the risk of fire or explosion. All possible ignition sources, including cigarette smoking, should be kept sufficiently far away from the site of installation, repairing, removing and disposal, during which refrigerant can possibly be released to the surrounding space. Prior to work taking place, the area around the equipment is to be surveyed to make sure that there are no flammable hazards or ignition risks. "No Smoking" signs shall be displayed.

(1-7) Ventilated Area

Ensure that the area is in the open or that it is adequately ventilated before breaking into the system or conducting any hot work. A degree of ventilation shall continue during the period that the work is carried out. The ventilation should safely disperse any released refrigerant and preferably expel it externally into the atmosphere.

(1-8) Checks on the Refrigeration Equipment

Where electrical components are being changed, they shall be fit for the purpose and to the correct specification. At all times the manufacturer's maintenance and service guidelines shall be followed. If in doubt, consult the manufacturer's technical department for assistance.

The following checks shall be applied to installations using flammable refrigerants:

- The charge size is in accordance with the room size within which the refrigerant containing parts are installed.
- The ventilation machinery and outlets are operating adequately and are not obstructed.
- Marking to the equipment continues to be visible and legible. Markings and signs that are illegible shall be corrected.
- Refrigeration pipe or components are installed in a position where they are unlikely to be exposed to any substance which may corrode refrigerant containing components, unless the components are constructed of materials which are inherently resistant to being corroded or are suitably protected against being corroded.

(1-9) Checks on Electrical Devices

Repair and maintenance to electrical components shall include initial safety checks and component inspection procedures. If a fault exists that could compromise safety, then no electrical supply shall be connected to the circuit until it is satisfactorily dealt with. If the fault cannot be corrected immediately but it is necessary to continue operation, an adequate temporary solution shall be used. This shall be reported to the owner of the equipment so all parties are advised. Initial safety checks shall include that:

- capacitors are discharged: this shall be done in a safe manner to avoid possibility of sparking;
- no live electrical components and wiring are exposed while charging, recovering or purging the system;
- there is continuity of earth bonding

(2) Repairs to Sealed Components

(2-1) During repairs to sealed components, all electrical supplies shall be disconnected from the equipment being worked upon prior to any removal of sealed covers, etc. If it is absolutely necessary to have an electrical supply to equipment during servicing, then a permanently operating form of leak detection shall be located at the most critical point to warn of a potentially hazardous situation.

(2-2) Particular attention shall be paid to the following to ensure that by working on electrical components, the casing is not altered in such a way that the level of protection is affected. This shall include damage to cables, excessive number of connections, terminals not made to original specification, damage to seals, incorrect fitting of glands, etc.

Ensure that the apparatus is mounted securely.

Ensure that seals or sealing materials have not degraded to the point that they no longer serve the purpose of preventing the ingress of flammable atmospheres.

Replacement parts shall be in accordance with the manufacturer's specifications.

(3) Repair to intrinsically Safe Components

Do not apply any permanent inductive or capacitance loads to the circuit without ensuring that this will not exceed the permissible voltage and current permitted for the equipment in use.

Intrinsically safe components are the only types that can be worked on while live in the presence of a flammable atmosphere. The test apparatus shall be at the correct rating.

Replace components only with parts specified by the manufacturer. Other parts may result in the ignition of refrigerant in the atmosphere from a leak.

(4) Cabling

Check that cabling will not be subject to wear, corrosion, excessive pressure, vibration, sharp edges or any other adverse environmental effects. The check shall also take into account the effects of aging or continual vibration from sources such as compressors or pumps.

(5) Detection of Flammable Refrigerants

Under no circumstances shall potential sources of ignition be used in the searching for or detection of refrigerant leaks. A halide torch (or any other detector using a naked flame) shall not be used.

(6) Leak Detection Methods

Electronic leak detectors may be used to detect refrigerant leaks but, in the case of flammable refrigerants, the sensitivity may not be adequate, or may need re-calibration. (Detection equipment shall be calibrated in a refrigerant-free area.)

Ensure that the detector is not a potential source of ignition and is suitable for the refrigerant used. Leak detection equipment shall be set at a percentage of the LFL of the refrigerant and shall be calibrated to the refrigerant employed, and the appropriate percentage of gas (25% maximum) is confirmed.

Leak detection fluids are suitable for use with most refrigerants but the use of detergents containing chlorine shall be avoided as the chlorine may react with the refrigerant and corrode the copper pipe-work.

If a leak is suspected, all naked flames shall be removed/extinguished.

If a leakage of refrigerant is found which requires brazing, all of the refrigerant shall be recovered from the system, or isolated (by means of shut off valves) in a part of the system remote from the leak. For appliances containing flammable refrigerants, oxygen free nitrogen (OFN) shall then be purged through the system both before and during the brazing process.

(7) Removal and Evacuation

When breaking into the refrigerant circuit to make repairs – or for any other purpose conventional procedures shall be used. However, for flammable refrigerants it is important that best practice is followed since flammability is a consideration. The following procedure shall be adhered to:

- remove refrigerant
- purge the circuit with inert gas
- evacuate
- purge again with inert gas
- open the circuit by cutting or brazing.

The refrigerant charge shall be recovered into the correct recovery cylinders. For appliances containing flammable refrigerants, the system shall be “flushed” with OFN to render the unit safe. This process may need to be repeated several times.

Compressed air or oxygen shall not be used for purging refrigerant systems.

For appliances containing flammable refrigerants, flushing shall be achieved by breaking the vacuum in the system with OFN and continuing to fill until the working pressure is achieved, then venting to atmosphere, and finally pulling down to a vacuum. This process shall be repeated until no refrigerant is within the system. When the final OFN charge is used, the system shall be vented down to atmospheric pressure to enable work to take place. This operation is absolutely vital if brazing operations on the pipe-work are to take place.

Ensure that the outlet for the vacuum pump is not close to any ignition sources and that ventilation is available.

(8) Charging Procedures

In addition to conventional charging procedures, the following requirements shall be followed:

- Ensure that contamination of different refrigerants does not occur when using charging equipment. Hoses or lines shall be as short as possible to minimize the amount of refrigerant contained in them.
- Cylinders shall be kept upright.
- Ensure that the refrigeration system is earthed prior to charging the system with refrigerant.
- Label the system when charging is complete (if not already).
- Extreme care shall be taken not to overfill the refrigeration system.

Prior to recharging the system, it shall be pressure-tested with the appropriate purging gas. The system shall be leak-tested on completion of charging but prior to commissioning. A follow up leak test shall be carried out prior to leaving the site.

(9) Decommissioning

Before carrying out this procedure, it is essential that the technician is completely familiar with the equipment and all its detail. It is recommended good practice that all refrigerants are recovered safely. Prior to the task being carried out, an oil and refrigerant sample shall be taken in case analysis is required prior to re-use of reclaimed refrigerant. It is essential that electrical power is available before the task is commenced.

- a) Become familiar with the equipment and its operation.

- b) Isolate system electrically.
- c) Before attempting the procedure, ensure that:
 - mechanical handling equipment is available, if required, for handling refrigerant cylinders;
 - all personal protective equipment is available and being used correctly;
 - the recovery process is supervised at all times by a competent person;
 - recovery equipment and cylinders conform to the appropriate standards.
- d) If a vacuum is not possible, make a manifold so that refrigerant can be removed from various parts of the system.
- e) Make sure that cylinder is situated on the scales before recovery takes place.
- f) Start the recovery machine and operate in accordance with manufacturer's instructions.
- g) Do not overfill cylinders. (No more than 80 % volume liquid charge).
- h) Do not exceed the maximum working pressure of the cylinder, even temporarily.
- i) When the cylinders have been filled correctly and the process completed, make sure that the cylinders and the equipment are removed from site promptly and all isolation valves on the equipment are closed off.
- j) Recovered refrigerant shall not be charged into another refrigeration system unless it has been cleaned and checked.

(10) Labelling

Equipment shall be labelled stating that it has been de-commissioned and emptied of refrigerant. The label shall be dated and signed. For appliances containing flammable refrigerants, ensure that there are labels on the equipment stating the equipment contains flammable refrigerant.

(11) Recovery

When removing refrigerant from a system, either for servicing or decommissioning, it is recommended good practice that all refrigerants are removed safely. When transferring refrigerant into cylinders, ensure that only appropriate refrigerant recovery cylinders are employed. Ensure that the correct number of cylinders for holding the total system charge are available. All cylinders to be used are designated for the recovered refrigerant and labelled for that refrigerant (i.e. special cylinders for the recovery of refrigerant). Cylinders shall be complete with pressure-relief valve and associated shut-off valves in good working order. Empty recovery cylinders are evacuated and, if possible, cooled before recovery occurs.

The recovery equipment shall be in good working order with a set of instructions concerning the equipment that is at hand and shall be suitable for the recovery of all appropriate refrigerants including, when applicable, flammable refrigerants. In addition, a set of calibrated weighing scales shall be available and in good working order. Hoses shall be complete with leak-free disconnect couplings and in good condition. Before using the recovery machine, check that it is in satisfactory working order, has been properly maintained and that any associated electrical components are sealed to prevent ignition in the event of a refrigerant release. Consult manufacturer if in doubt.

The recovered refrigerant shall be returned to the refrigerant supplier in the correct recovery cylinder, and the relevant waste transfer note arranged. Do not mix refrigerants in recovery units and especially not in cylinders. If compressors or compressor oils are to be removed, ensure that they have been evacuated to an acceptable level to make certain that flammable refrigerant does not remain within the lubricant. The evacuation process shall be carried out prior to returning the compressor to the suppliers. Only electric heating to the compressor body shall be employed to accelerate this process. When oil is drained from a system, it shall be carried out safely.

[5] Service tools

Use the below service tools as exclusive tools for R32 refrigerant.

No.	Tool name	Specifications
①	Gauge manifold	• Only for R32
		• Use the existing fitting specifications. (UNF7/16)
		• Use high-tension side pressure of 5.3 MPa·G or over.
②	Charge hose	• Only for R32
		• Use pressure performance of 5.09 MPa·G or over.
③	Electronic weighing scale	—
④	Gas leak detector	• Use the detector for R134A, R407C, R410A or R32.
⑤	Adaptor for reverse flow check	• Attach on vacuum pump.
⑥	Refrigerant charge base	—
⑦	Refrigerant cylinder	• Only for R32
		• Cylinder with syphon
⑧	Refrigerant recovery equipment	—

2-3. PRECAUTIONS WHEN REUSING EXISTING R22/R410A REFRIGERANT PIPES

(1) Flowchart

- Refer to the flowchart below to determine if the existing pipes can be used and if it is necessary to use a filter drier.
- If the diameter of the existing pipes is different from the specified diameter, refer to technical data materials to confirm if the pipes can be used.

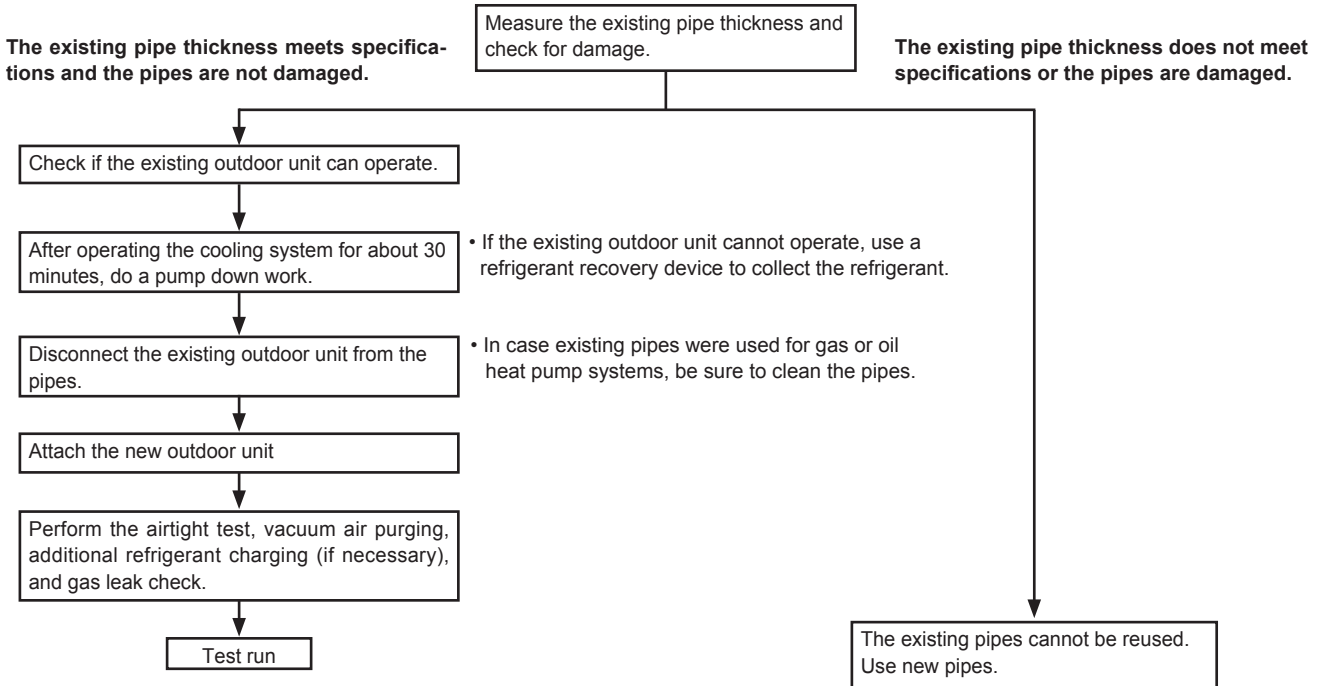

(2) Cautions for refrigerant piping work

New refrigerant R32 is adopted for replacement inverter series. Although the refrigerant piping work for R32 is same as for R22, exclusive tools are required to avoid mixing with different types of refrigerant. Furthermore as the working pressure of R32 is 1.6 times higher than that of R22, their sizes of flared sections and flare nuts are different.

① Thickness of pipes

Because the working pressure of R32 is higher compared to R22, be sure to use refrigerant piping with thickness shown below. (Never use pipes of 1/32 inch [0.7 mm] or below.)

Diagram below: Piping diameter and thickness

Nominal dimensions (inch)	Outside diameter (mm)	Thickness (inch [mm])	
		R32/R410A	R22
1/4	6.35	1/32 [0.8]	1/32 [0.8]
3/8	9.52	1/32 [0.8]	1/32 [0.8]
1/2	12.70	1/32 [0.8]	1/32 [0.8]
5/8	15.88	3/64 [1.0]	3/64 [1.0]
3/4	19.05	—	3/64 [1.0]

② Dimensions of flare cutting and flare nut

The component molecules in HFC refrigerant are smaller compared to the conventional refrigerants. In addition, R32 is a refrigerant, which has higher risk of leakage because its working pressure is higher than that of other refrigerants.

Therefore, to enhance airtightness and strength, flare cutting dimension of copper pipe for R32 has been specified separately from the dimensions for other refrigerants as shown below. The dimension B of the flare nut for R32 also has partly been changed to increase strength as shown below. Set copper pipe correctly referring to copper pipe flaring dimensions for R32 below. For 1/2 and 5/8 inch pipes, the dimension B changes.

Use torque wrench corresponding to each dimension.

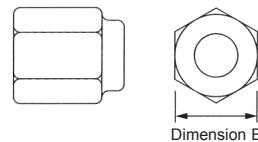
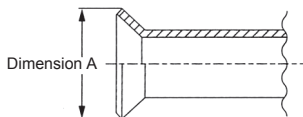

Flare cutting dimensions

Nominal dimensions (inch)	Outside diameter (mm)	Dimension A ($\pm \frac{0}{164}$) (inch [mm])	
		R32	R22
1/4	6.35	23/64 [9.1]	23/64 [9.0]
3/8	9.52	33/64 [13.2]	33/64 [13.0]
1/2	12.70	21/32 [16.6]	41/64 [16.2]
5/8	15.88	25/32 [19.7]	49/64 [19.4]
3/4	19.05	—	59/64 [23.3]

Flare nut dimensions

Nominal dimensions (inch)	Outside diameter (mm)	Dimension B (inch [mm])	
		R32	R22
1/4	6.35	43/64 [17.0]	43/64 [17.0]
3/8	9.52	55/64 [22.0]	55/64 [22.0]
1/2	12.70	1-1/32 [26.0]	15/16 [24.0]
5/8	15.88	1-9/64 [29.0]	1-1/16 [27.0]
3/4	19.05	—	1-27/64 [36.0]

③ Tools for R32 (The following table shows whether conventional tools can be used or not.)

Tools and materials	Use	R32 tools	Can R22 tools be used?	Can R407C tools be used?	Can R410A tools be used?
Gauge manifold	Air purge, refrigerant charge and operation check	Tool exclusive for R32	×	×	○
Charge hose	Air purge, refrigerant charge and operation check	Tool exclusive for R32	×	×	○
Gas leak detector	Gas leak check	Tool for HFC refrigerant	×	○	○
Refrigerant recovery equipment	Refrigerant recovery	Tool exclusive for R32	×	×	○
Refrigerant cylinder	Refrigerant charge	Tool exclusive for R32	×	×	×
Safety charger	Prevent compressor malfunction when charging refrigerant by spraying liquid refrigerant	Tool exclusive for R32	×	×	○
Charge valve	Prevent gas from blowing out when detaching charge hose	Tool exclusive for R32	×	×	○
Vacuum pump	Vacuum drying and air purge	Tools for other refrigerants can be used if equipped with adapter for reverse flow check	△(Usable if equipped with adapter for reverse flow)	△(Usable if equipped with adapter for reverse flow)	△(Usable if equipped with adapter for reverse flow)
Flaring tool	Flaring work of piping	Tools for other refrigerants can be used by adjusting flaring dimension	△(Usable by adjusting flaring dimension)	△(Usable by adjusting flaring dimension)	△(Usable by adjusting flaring dimension)
Bender	Bend the pipes	Tools for other refrigerants can be used	○	○	○
Pipe cutter	Cut the pipes	Tools for other refrigerants can be used	○	○	○
Welder and nitrogen gas cylinder	Weld the pipes	Tools for other refrigerants can be used	○	○	○
Refrigerant charging scale	Refrigerant charge	Tools for other refrigerants can be used	○	○	○
Vacuum gauge or thermistor vacuum gauge and vacuum valve	Check the degree of vacuum. (Vacuum valve prevents back flow of oil and refrigerant to thermistor vacuum gauge)	Tools for other refrigerants can be used	○	○	○
Charging cylinder	Refrigerant charge	Tool exclusive for R32	×	—	×

×: Prepare a new tool. (Use the new tool as the tool exclusive for R32.)

△: Tools for other refrigerants can be used under certain conditions.

○: Tools for other refrigerants can be used.

2-4. Choosing the outdoor unit installation location

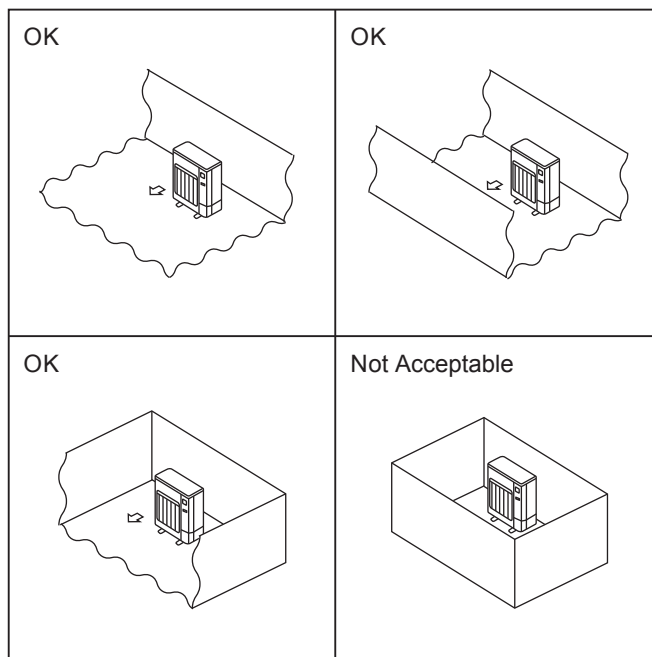

R32 is heavier than air—as well as other refrigerants—so tends to accumulate at the base (in the vicinity of the floor). If R32 accumulates around base, it may reach a flammable concentration in case room is small. To avoid ignition, maintaining a safe work environment is required by ensuring appropriate ventilation. If a refrigerant leak is confirmed in a room or an area where there is insufficient ventilation, refrain from using of flames until the work environment can be improved by ensuring appropriate ventilation.

Install outdoor units in a place where at least one of the four sides is open, and in a sufficiently large space without depressions.

3

SPECIFICATIONS

			WUZ-SA24NMZ	WUZ-SA36NMZ	WUZ-SA48NMZ
Power supply	Phase	-	Single		
	Voltage	V	208 / 230		
	Frequency	Hz	60		
	MCA	A	27	32	37
	MOP	A	43	52	61
	Braker size	A	30	35	40
Unit Dimensions		W : In. [mm]	41 11/32 [1050]		
		D : In. [mm]	18 29/32 [480]		
		H : In. [mm]	40 30/32 [1040]		
Weight		lbs. [kg]	236 [107]	236 [107]	252 [114]
Refrigerant(GWP)		-	R32(675)		
Ref. amount	Charge less	lbs. oz. [kg]	3, 15.5[1.8]		
	Max.	lbs. oz. [kg]	5, 4.6[2.4]		
Design Pressure(High side_Cooling/ Heating)		PSIG [MPa]	581[4.00] / 708[4.88]		
Pipe size O.D	Liquid	in	1/4[ø6.35]		
	Gas	in	5/8[ø15.88]		
Connection type		-	Flared		
Distance between IDU and ODU	Hight difference (Max.)	ft [m]	100[30]		
	Charge less pipe length (reversible)	ft [m]	50[15]	Additional charged is needed	
	Charge less pipe length (Heating only)	ft [m]	114[35]	100[30]	
	Max available pipe length (reversible)	ft [m]	164[50]	100[30]	
	Max available pipe length (Heating Only)	ft [m]	164[50]		
Guaranteed Operating temperature	Heating	°F [°C]	-22 ~ 75[-30 ~ 24]		
	Cooling	°F [°C]	50 ~ 114[10 ~ 46]		
	DHW	°F [°C]	-22 ~ 107[-30 ~ 42]		
	Outlet water temp (Heating/ DHW)	-	Refer to graph		
Water flow rate range		gallon/min [L/min]	1.9 to 6.0 [7.2 to 22.9]	2.6 to 7.5 [10.0 to 28.6]	2.6 to 9.0 [10.0 to 34.4]
Power Level	PWL (Heating A7W55)	dBA	56	60	60
Sound Pressure Level	SPL (Heating A7W55)	dBA	41	45	45
Performance *1	A7W35	Kbtu [kW]	20.00[5.90]	27.00[7.90]	40.00[11.70]
		COP	5.05	5.05	4.85
	A2W35	Kbtu [kW]	24.00[7.03]	36.00[10.55]	48.00[14.07]
		COP	3.60	3.40	3.30
	A-15W43	Kbtu [kW]	24.00[7.03]	36.00[10.55]	48.00[14.07]
		COP	2.00	2.05	2.05
	A35W7	Kbtu [kW]	24.00[7.03]	30.00[9.00]	42.00[12.50]
		COP	3.30	3.00	2.60
A35W18	Kbtu [kW]	27.00[7.90]	34.00[10.00]	48.00[14.07]	
	COP	4.95	4.50	3.75	

4-1. REFILLING REFRIGERANT CHARGE (R32: kg [lbs oz])

Heating only		Initial amount	Chargeless piping length	Permitted piping length	Permitted vertical difference	Additional charge amount per length when piping length > chargeless length	Max. allowable amount *2
WUZ-	SA24/36NMZ	1.80 kg [3 lbs 15.5 oz]	35 m [114 ft]	50 m [164 ft]	30 m [100 ft]	+43 g/1.524 m +1.5 oz/5 ft	2.20 kg [4 lbs 13.6 oz]
	SA48NMZ	1.80 kg [3 lbs 15.5 oz]	30 m [100 ft]	50 m [164 ft]	30 m [100 ft]	+43 g/1.524 m +1.5 oz/5 ft	2.40 kg [5 lbs 4.6 oz]
Reversible (Cooling and Heating)		Initial amount	Chargeless piping length	Permitted piping length	Permitted vertical difference	Additional charge amount per length when piping length > chargeless length	Max. allowable amount *2
WUZ-	SA24/36NMZ	1.80 kg [3 lbs 15.5 oz]	15 m [50 ft]	50 m [164 ft]	30 m [100 ft]	+28 g/1.524 m +1 oz/5 ft	2.40 kg [5 lbs 4.6 oz]
	SA48NMZ	1.80 kg [3 lbs 15.5 oz]	+0.4 kg (less than 3 m) *3 +14 oz (less than 9.8 ft)	30 m [100 ft]	30 m [100 ft]	+28 g/1.524 m +1 oz/5 ft	2.40 kg [5 lbs 4.6 oz]

*1 When setting the water temperature to 60°C, 140°F or higher, add the refrigerant amount for the "reversible" even when using the "heating only". Otherwise, the system may not operate due to the refrigerant shortage.

*2 The total amount of refrigerant must not exceed the Max. allowable amount. Even if the refrigerant amount which is calculated by extended piping exceeds the Max. allowable amount, please do not charge refrigerant over the Max. allowable amount.

*3 The piping length of 5 m, 16 ft is usable without additional refrigerant charging, if the cases below are allowable.

- The maximum cooling capacity may drop over 20 percent. In this case, the cooling efficiency will be less and the input increases as well.
- Running noise may occur from the extended piping or the indoor unit.

4-2. COMPRESSOR TECHNICAL DATA

(Winding temperature at 68°F)

Service Ref.		WUZ-SA24NMZ WUZ-SA36NMZ	WUZ-SA48NMZ
Compressor model		DVK28FEJMT	DVK36FEGMT
Winding Resistance (Ω)	U-V	0.943	0.315
	U-W	0.943	0.315
	W-V	0.943	0.315

4-3. NOISE CRITERION CURVES

WUZ-SA24NMZ-U1

MODE	SPL(dBA)	LINE
HEATING	41	

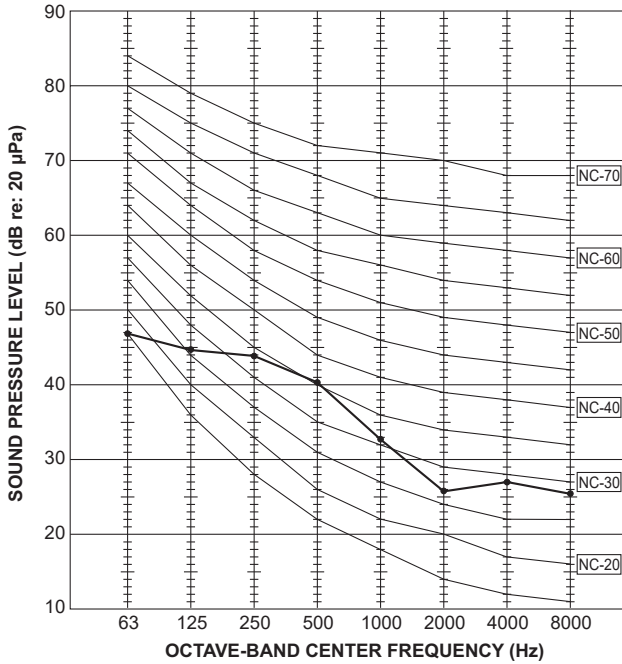

WUZ-SA36NMZ-U1

MODE	SPL(dBA)	LINE
HEATING	45	

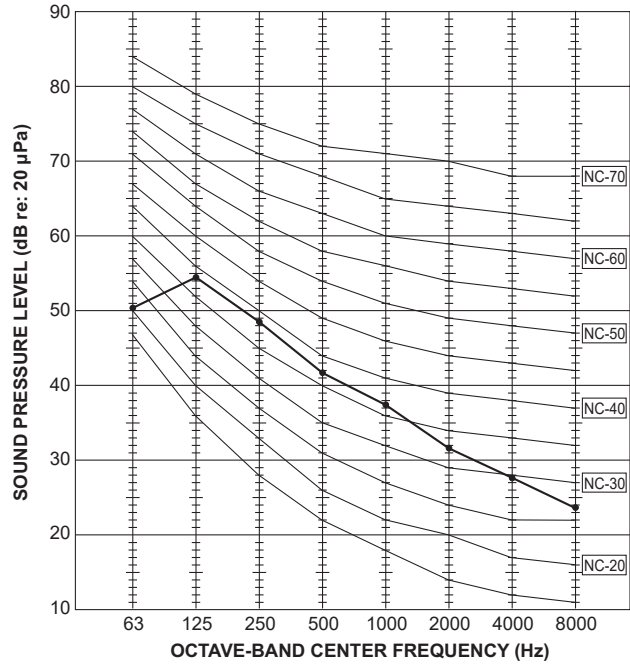

WUZ-SA48NMZ-U1

MODE	SPL(dBA)	LINE
HEATING	45	

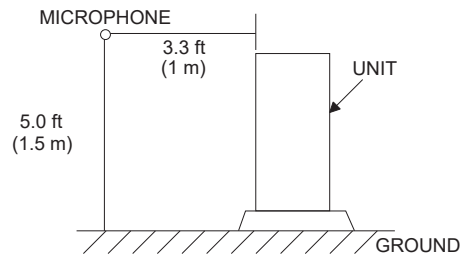
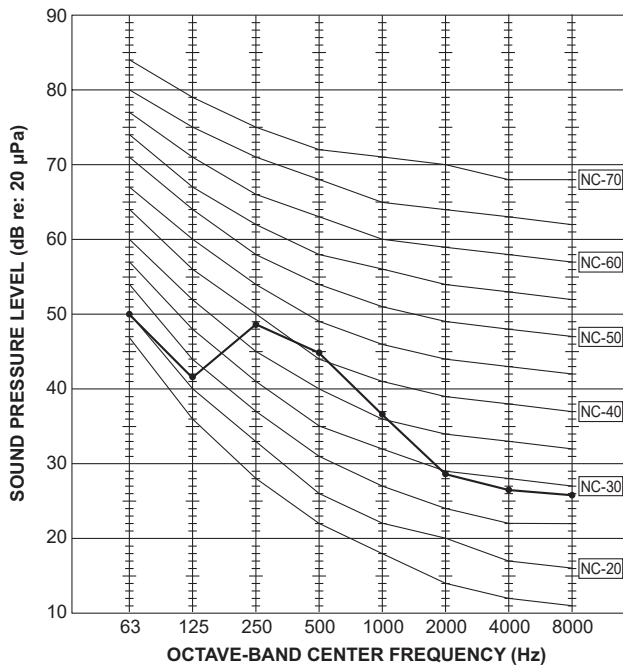

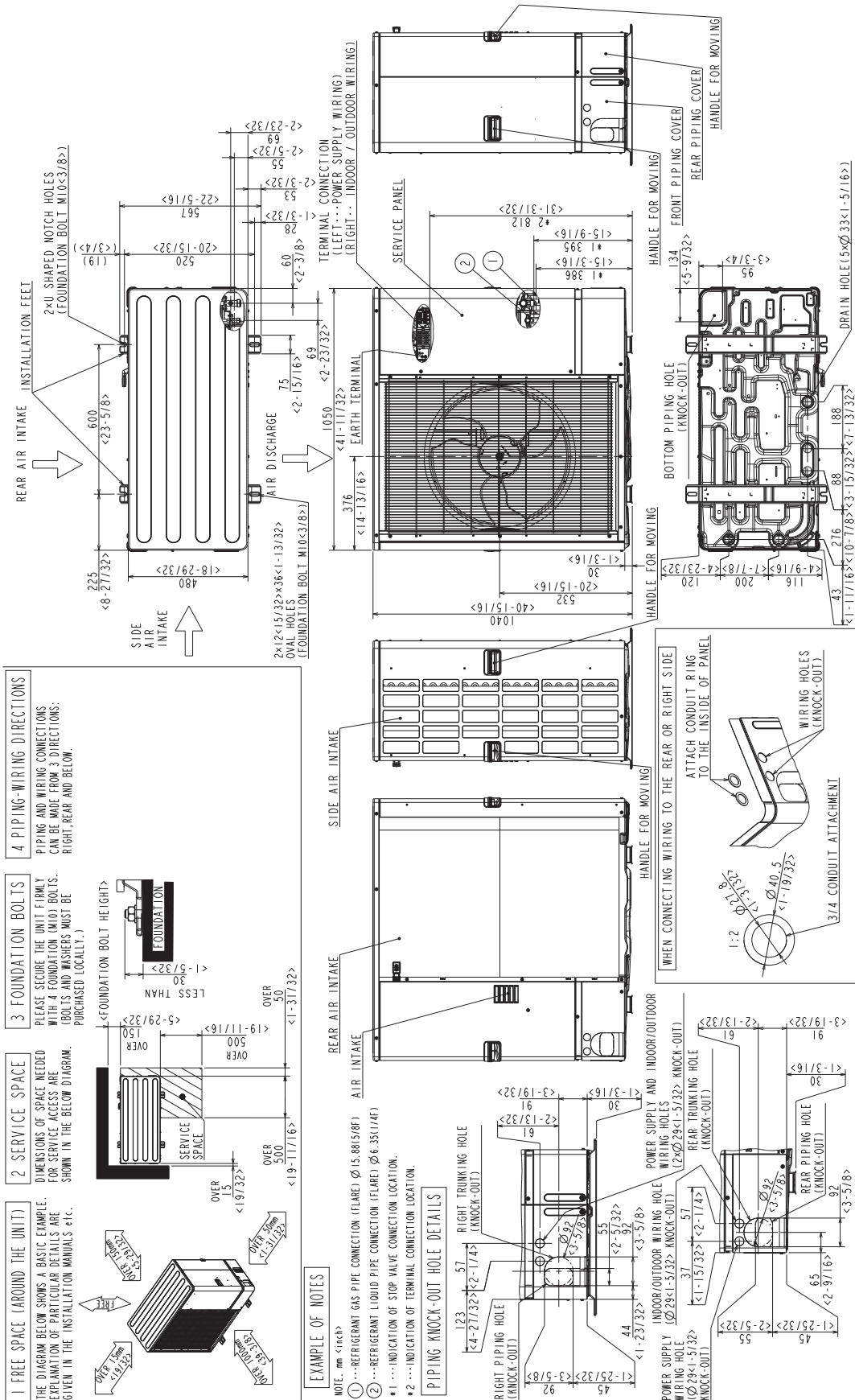

FIELD ELECTRICAL WIRING (power wiring specifications)

Outdoor unit model		WUZ-SA24NMZ	WUZ-SA36NMZ	WUZ-SA48NMZ
Outdoor unit power supply		~ (single), 60 Hz, 208/230 V	~ (single), 60 Hz, 208/230 V	~ (single), 60 Hz, 208/230 V
Outdoor unit input capacity Main switch (Breaker) *1		30 A	35 A	40 A
Wiring Wire No. × size	Outdoor unit power supply	3 × Min. AWG 11	3 × Min. AWG 11	3 × Min. AWG 9
	Indoor unit-Outdoor unit	3 × AWG 16 (Polar)	3 × AWG 16 (Polar)	3 × AWG 16 (Polar)
	Indoor unit-Outdoor unit ground	1 × Min. AWG 16	1 × Min. AWG 16	1 × Min. AWG 16
	Remote controller-Indoor unit	2 × AWG 22 (Non-polar)	2 × AWG 22 (Non-polar)	2 × AWG 22 (Non-polar)
Circuit rating	Outdoor unit L1-L2 (single)	230 VAC	230 VAC	230 VAC
	Indoor unit-Outdoor unit S1-S2	230 VAC	230 VAC	230 VAC
	Indoor unit-Outdoor unit S2-S3	28 VDC	28 VDC	28 VDC
	Remote controller-Indoor unit	12 VDC	12 VDC	12 VDC

*1. A breaker with at least 3.0 mm, 1/8 inches contact separation in each poles shall be provided. Use earth leakage breaker (NV).

Make sure that the ground fault circuit interrupter is one compatible with higher harmonics.

Always use a ground fault circuit interrupter that is compatible with higher harmonics as this unit is equipped with an inverter.

The use of an inadequate breaker can cause the incorrect operation of inverter.

*2. Max. 45 m, 147 ft

If 2.5 mm², AWG 13 used, Max. 50 m, 164 ft

If 2.5 mm², AWG 13 used and S3 separated, Max. 80 m, 262 ft

*3. The 10 m, 32 ft wire is attached in the remote controller accessory.

*4. The figures are NOT always against the ground.

S3 terminal has 28 VDC against S2 terminal. However between S3 and S1, these terminals are NOT electrically insulated by the transformer or other device.

Notes: 1. Field-installed wiring must comply with the applicable local and national codes.

2. Power supply cables and the cables between Interface unit/Flow temp. controller and outdoor unit shall not be lighter than polychloroprene sheathed flexible cables. (Design 60245 IEC 57)

3. Be sure to connect the cables between Interface unit/Flow temp. controller and outdoor unit directly to the units (no intermediate connections are allowed).

Intermediate connections may result in communication errors. If water enters at the intermediate connection point, it may cause insufficient insulation to ground or a poor electrical contact.

(If an intermediate connection is necessary, be sure to take measures to prevent water from entering the cables.)

4. Install an earth longer than other cables.

5. Do not construct a system with a power supply that is turned ON and OFF frequently.

6. Use self-extinguishing distribution cables for power supply wiring.

7. Properly route wiring so as not to contact the sheet metal edge or a screw tip.

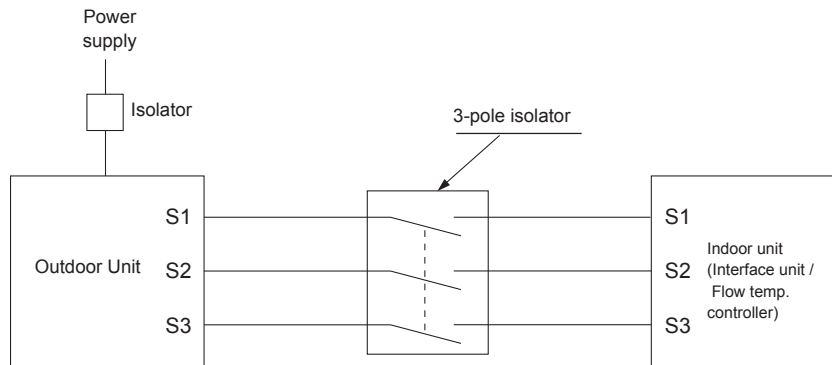

⚠ WARNING:

- In case of A-control wiring, there is high voltage potential on the S3 terminal caused by electrical circuit design that has no electrical insulation between power supply wire and communication signal line. Therefore, please turn off the main power supply when servicing. And do not touch the S1, S2, S3 terminals when the power is energized. If isolator should be used between indoor unit and outdoor unit, please use 3 pole type.

Never splice the power cable or the indoor-outdoor connection cable, otherwise it may result in a smoke, a fire or communication failure.

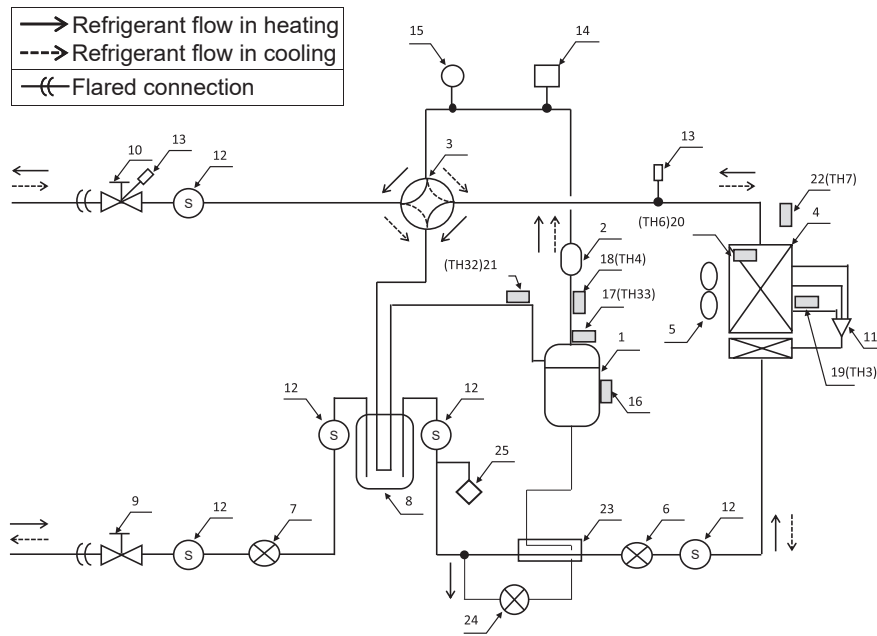

No.	Parts name
1	Compressor
2	Muffler
3	4-Way Valve Heating: Coil ON/ Cooling: Coil OFF
4	Air Heat Exchanger
5	Fan Motor
6	Linear Expansion Valve - A
7	Linear Expansion Valve - B
8	Power Receiver
9	Liquid Stop Valve - 1/4"
10	Gas Stop Valve - 5/8"
11	Distributor
12	Strainer
13	Service Port - 7/16"
14	High Pressure Switch
15	High Pressure Sensor
16	Thermal Protector
17	Thermistor - Comp surface temp.
18	Thermistor - Discharge temp.
19	Thermistor - Liquid temp.
20	Thermistor - Two phase pipe temp.
21	Thermistor - Suction temp.
22	Thermistor - Ambient temp.
23	Heat Inter Changer
24	Linear Expansion Valve - C
25	Fusible plug

REFRIGERANT COLLECTING (PUMP DOWN)

When relocating or disposing of the indoor/outdoor unit, pump down the system following the procedure below so that no refrigerant is released into the atmosphere.

- ① Turn off the power supply (circuit breaker).
- ② Connect the low pressure valve on the gauge manifold to the service port of the gas stop valve on the outdoor unit.
- ③ Close the liquid stop valve completely.
- ④ Supply power (circuit breaker).
 - Startup of the indoor-outdoor communication takes about 3 minutes after the power (circuit breaker) is turned on. Start the pump-down operation 3 to 4 minutes after the power (circuit breaker) is turned on.
- ⑤ Perform the refrigerant collecting operation (cooling test run).
 - Push the pump-down SWP switch (push-button type) on the control board of the outdoor unit. The compressor and ventilators (outdoor unit) start operating (refrigerant collecting operation begins). (LED1 and LED2 on the control board of the outdoor unit are lit.)
 - Only push the pump-down SWP switch if the unit is stopped. However, even if the unit is stopped and the pump-down SWP switch is pushed less than 3 minutes after the compressor stops, the refrigerant collecting operation cannot be performed. Wait until the compressor has been stopped for 3 minutes and then push the pump-down SWP switch again.
- ⑥ Fully close the gas stop valve on the gas pipe side of the outdoor unit when the pressure gauge on the gauge manifold shows 0.05 to 0 MPa [Gauge] (approx. 0.5 to 0 kgf/cm²) and quickly stop the outdoor unit.
 - Because the unit automatically stops in about 3 minutes when the refrigerant collecting operation is completed (LED1 off, LED2 lit), be sure to quickly close the gas stop valve. However, if LED1 is lit, LED2 is off, and the unit is stopped, open the liquid stop valve completely, close the valve completely after 3 minutes or more have passed, and then repeat step ⑤. (Open the gas stop valve completely.)
 - If the refrigerant collecting operation has been completed normally (LED1 off, LED2 lit), the unit will remain stopped until the power supply is turned off.
 - Note that if the extension piping is very long with a large refrigerant amount, it may not be possible to perform a pump-down operation. In this case, use refrigerant recovery equipment to collect all of the refrigerant in the system.
- ⑦ Turn off the power supply (circuit breaker), remove the gauge manifold, and then disconnect the refrigerant pipes.

⚠ WARNING:

When the refrigeration circuit has a leak, DO NOT execute pump down with the compressor.

When pumping down the refrigerant, stop the compressor before disconnecting the refrigerant pipes.

- **If the refrigerant pipes are disconnected while the compressor is operating and the stop valve (ball valve) is open, the pressure in the refrigeration cycle become extremely high if air is drawn in, causing the pipes to burst, personal injury, etc.**

9-1. TROUBLESHOOTING

<Error code displayed by self-diagnosis and actions required for service (summary)>

Present and past error codes are logged, and they can be displayed on the control board of outdoor unit. Actions to be taken for service, which depends on whether or not the trouble is reoccurring in the field, are summarized in the table below. Check the contents below before investigating details.

Unit conditions at service	Error code	Actions required for service (summary)
The trouble is reoccurring.	Displayed	Judge what is wrong and take a corrective action according to "9-2. SELF-DIAGNOSIS ACTION TABLE".
	Not displayed	Conduct troubleshooting to identify the cause of the trouble according to "9-3. TROUBLESHOOTING OF PROBLEMS".
The trouble is not reoccurring.	Logged	① Consider the temporary defects such as the work of protection devices in the refrigerant circuit including compressor, poor connection of wiring, noise, etc. Re-check the symptom, and check the installation environment, refrigerant amount, weather when the trouble occurred, matters related to wiring, etc. ② Reset error code logs and restart the unit after finishing service. ③ There is no abnormality in electrical component, controller board, remote controller, etc.
	Not logged	① Re-check the abnormal symptom. ② Conduct troubleshooting to identify the cause of the trouble according to "9-3. TROUBLESHOOTING OF PROBLEMS". ③ Continue to operate unit for the time being if the cause is not ascertained. ④ There is no abnormality concerning of parts such as electrical component, controller board, remote controller, etc.

9-2. SELF-DIAGNOSIS ACTION TABLE

<Abnormalities detected when the power is turned on> Note: Refer to indoor unit section for code P, code E, and Code L.

Error code	Abnormal point and detection method	Cause	Judgment and action
None	—	① No voltage is supplied to terminal block (TB1) of outdoor unit. a) Power supply breaker is turned off. b) Contact failure or disconnection of power supply terminal c) Open phase (L1 or L2 phase) ② Electric power is not supplied to power supply terminal of outdoor power circuit board. a) Contact failure of power supply terminal b) Open phase on the outdoor power circuit board (Disconnection of terminal on outdoor power circuit board) ③ Electric power is not supplied to outdoor controller circuit board. a) Disconnection of connector (CNDC) ④ Disconnection of reactor (DCL) ⑤ Disconnection of outdoor noise filter circuit board or parts failure in outdoor noise filter circuit board (SA48NMZ) ⑥ Defective outdoor power circuit board ⑦ Defective outdoor noise filter circuit board (SA48NMZ) ⑧ Defective outdoor controller circuit board	① Check following items. a) Power supply breaker b) Connection of power supply terminal block (TB1) c) Connection of power supply terminal block (TB1) ② Check following items. a) Connection of power supply terminal block (TB1) b) Connection of terminal on outdoor power circuit board ③ Check connection of the connector (CNDC) on the outdoor controller circuit board. Check connection of the connector, CNDC on the noise filter. Refer to "9-6.TEST POINT DIAGRAM". ④ Check connection of reactor. (DCL) Refer to "9-6.TEST POINT DIAGRAM". ⑤ a) Check connection of outdoor noise filter circuit board. b) Replace outdoor noise filter circuit board. Refer to "9-6.TEST POINT DIAGRAM". ⑥ Replace outdoor power circuit board. ⑦ Replace outdoor noise filter circuit board (SA48NMZ). ⑧ Replace controller board (When items above are checked but the units cannot be repaired).

Error code	Abnormal point and detection method	Cause	Judgment and action
F5 (5201)	63H connector open Abnormal if 63H connector circuit is open for 3 minutes continuously after power supply. 63H: High pressure switch	<ul style="list-style-type: none"> ① Disconnection or contact failure of 63H connector on outdoor controller circuit board ② Disconnection or contact failure of 63H ③ 63H is working due to defective parts. ④ Defective outdoor controller circuit board 	<ul style="list-style-type: none"> ① Check connection of 63H connector on outdoor controller circuit board. Refer to "9-6.TEST POINT DIAGRAM". ② Check the 63H side of connecting wire. ③ Check continuity by multimeter. Replace the parts if the parts are defective. ④ Replace outdoor controller circuit board.
EA (6844)	Indoor/outdoor unit connector miswiring, excessive number of units (2 units or more) <ul style="list-style-type: none"> • Outdoor controller circuit board can automatically check the number of connected indoor units. Abnormal if the number cannot be checked automatically due to miswiring of indoor/outdoor unit connecting wire and etc. after power is turned on for 4 minutes. • Abnormal if outdoor controller circuit board recognizes the number of connected indoor units as "2 units or more". 	<ul style="list-style-type: none"> ① Contact failure or miswiring of indoor/outdoor unit connecting wire ② Diameter or length of indoor/outdoor unit connecting wire is out of specified capacity. ③ 2 or more indoor units are connected to one outdoor unit. ④ Defective transmitting receiving circuit of outdoor controller circuit board ⑤ Defective transmitting receiving circuit of indoor controller board ⑥ Defective indoor power board ⑦ Do NOT use refrigerant address 0, as 0 is used for FTC (Master). The address range is 1 to 6. (In the case of multiple outdoor units control.) ⑧ Noise has entered into power supply or indoor/outdoor unit connecting wire. 	<ul style="list-style-type: none"> ① Check disconnection or looseness or polarity of indoor/outdoor unit connecting wire of indoor and outdoor units. ② Check diameter and length of indoor/outdoor unit connecting wire. Total wiring length: 262.5 ft (80 m) (including wiring connecting each indoor unit and between indoor and outdoor unit) Also check if the connection order of flat cable is S1, S2, S3. ③ Check the number of indoor units that are connected to one outdoor unit. (If EA is detected) ④-⑥ Turn the power off once, and on again to check. Replace outdoor controller circuit board, indoor controller board or indoor power board if abnormality occurs again. ⑦ Check if refrigerant addresses (SW1-3 to SW1-6 on outdoor controller circuit board) are overlapping in the case of multiple outdoor units control.
Eb (6845)	Miswiring of indoor/outdoor unit connecting wire (converse wiring or disconnection) Outdoor controller circuit board can automatically set the unit number of indoor units. Abnormal if the indoor unit number cannot be set within 4 minutes after power on because of miswiring (converse wiring or disconnection) of indoor/outdoor unit connecting wire.	<ul style="list-style-type: none"> ① Contact failure or miswiring of indoor/outdoor unit connecting wire ② Diameter or length of indoor/outdoor unit connecting wire is out of specified capacity. ④ Defective transmitting receiving circuit of outdoor controller circuit board ⑤ Defective transmitting receiving circuit of indoor controller board ⑥ Defective indoor power board ⑦ Do NOT use refrigerant address 0, as 0 is used for FTC (Master). The address range is 1 to 6. (In the case of multiple outdoor units control.) ⑧ Noise has entered into power supply or indoor/outdoor unit connecting wire. 	<ul style="list-style-type: none"> ⑧ Check transmission path, and remove the cause. <p>Note: The descriptions above, ①-⑧, are for EA, Eb and EC.</p>
EC (6846)	Startup time over The unit cannot finish startup process within 4 minutes after power on.	<ul style="list-style-type: none"> ① Contact failure of indoor/outdoor unit connecting wire ② Diameter or length of indoor/outdoor unit connecting wire is out of specified capacity. ③ Do NOT use refrigerant address 0, as 0 is used for FTC (Master). The address range is 1 to 6. (In the case of multiple outdoor units control.) ④ Noise has entered into power supply or indoor/outdoor unit connecting wire. 	
EE (7130)	Incorrect connection The outdoor unit does not receive the signals of I/F or FTC.	<ul style="list-style-type: none"> ① A device other than Interface unit or Flow temp. controller unit is connected to the unit. 	<ul style="list-style-type: none"> ① Connect I/F or FTC to the unit.

<Abnormalities detected while unit is operating>

Error code	Abnormal point and detection method	Cause	Judgment and action
U1 (1302)	<p>High pressure (High pressure switch 63H operated) Abnormal if high pressure switch 63H operated (4.80 MPa) during compressor operation.</p> <p>63H: High pressure switch</p>	<p>① Short cycle of indoor unit ② Clogged filter of indoor unit ③ Decreased airflow caused by dirt of indoor fan ④ Dirt of indoor heat exchanger ⑤ Locked indoor fan motor ⑥ Malfunction of indoor fan motor ⑦ Defective operation of stop valve (Not fully open) ⑧ Clogged or broken pipe ⑨ Locked outdoor fan motor ⑩ Malfunction of outdoor fan motor ⑪ Short cycle of outdoor unit ⑫ Dirt of outdoor heat exchanger ⑬ Decreased airflow caused by defective inspection of outside temperature thermistor (It detects lower temperature than actual temperature.) ⑭ Disconnection or contact failure of connector (63H) on outdoor controller board ⑮ Disconnection or contact failure of 63H connection ⑯ Defective outdoor controller board ⑰ Defective action of linear expansion valve ⑱ Malfunction of fan driving circuit</p>	<p>①-⑥ Check indoor unit and repair defect. ⑦ Check if stop valve is fully open. ⑧ Check outdoor unit and repair defect. ⑨-⑫ Check outdoor unit and repair defect. ⑬ Check the detected temperature of outside temperature thermistor on LED display. (SW2 on A-Control Service Tool: Refer to "9-7. FUNCTION OF SWITCHES, CONNECTORS AND JUMPERS".) ⑭-⑯ Turn the power off and check F5 is displayed when the power is turned again. When F5 is displayed, refer to "Judgment and action" for F5. ⑰ Check linear expansion valve. Refer to "9-4. HOW TO CHECK THE PARTS". ⑱ Replace outdoor controller board.</p>
U2 (TH4:1102) (TH33:1132)	<p>High discharge temperature • Abnormal if TH4 exceeds 257°F (125°C) or 230°F (110°C) continuously for 5 minutes. Abnormal if TH4 exceeds 230°F (110°C) or more continuously for 30 seconds after 90 seconds have passed since the defrosting operation started. • Abnormal if discharge superheat (Heating: TH4-T63HS) exceeds 158°F (70°C) continuously for 10 minutes.</p> <p>TH4: Thermistor <Discharge></p> <p>High comp. surface temperature Abnormal if TH33 exceeds 257°F (125°C). In the case of high comp. surface temperature error, compressor does not restart unless the thermistor (TH33) becomes less than 203°F (95°C).</p> <p>TH33: Thermistor <Comp. surface></p>	<p>① Overheated compressor operation caused by shortage of refrigerant ② Defective operation of stop valve ③ Defective thermistor ④ Defective outdoor controller board ⑤ Defective action of linear expansion valve ⑥ Clogging with foreign objects in refrigerant circuit Note: Clogging occur in the parts which become below freezing point when water enters in refrigerant circuit. ⑦ In the case of the unit does not restart: Detection temp. of thermistor (TH33) ≥ 203°F (95°C)</p>	<p>① Check intake superheat. Check leakage of refrigerant. Charge additional refrigerant. ② Check if stop valve is fully open. ③④ Turn the power off and check if U3 is displayed when the power is turned on again. When U3 is displayed, refer to "Judgment and action" for U3. ⑤ Check linear expansion valve. Refer to "9-4. HOW TO CHECK THE PARTS". ⑥ After recovering refrigerant, remove water from entire refrigerant circuit under vacuum more than 1 hour.</p>
U3 (TH4:5104) (TH33:5132)	<p>Open/short circuit of outdoor unit temperature thermistor (TH4, TH33) Abnormal if open (-4°F [-20°C] or less) or short (422.6°F [217°C] or more) is detected during compressor operation. (Detection is inoperative for 10 minutes of compressor starting process and for 10 minutes after and during defrosting.)</p> <p>TH4: Thermistor <Discharge> TH33: Thermistor <Comp. surface></p>	<p>① Disconnection or contact failure of connectors (TH4, TH33) on the outdoor controller circuit board ② Defective thermistor ③ Defective outdoor controller circuit board</p>	<p>① Check connection of connector (TH4, TH33) on the outdoor controller circuit board. Check breaking of the lead wire for TH4, TH33. Refer to "9-6. TEST POINT DIAGRAM". ② Check resistance value of TH4, TH33 or temperature by microprocessor. (Thermistor/TH4, TH33: Refer to "9-4. HOW TO CHECK THE PARTS".) (SW2 on A-Control Service Tool: Refer to "9-7. FUNCTION OF SWITCHES, CONNECTORS AND JUMPERS".) ③ Replace outdoor controller board.</p>

Error code	Abnormal point and detection method	Cause	Judgment and action	
U4 (TH3:5105) (TH6:5107) (TH7:5106) (TH8:5110) (TH32:5105)	Open/short of outdoor unit thermistors (TH3, TH32, TH6, TH7, and TH8) Abnormal if open or short is detected during compressor operation. Open detection of TH3, TH32 and TH6 is inoperative for 10 seconds to 10 minutes after compressor starting and 10 minutes after and during defrosting. Note: Check which unit has abnormality in its thermistor by switching the mode of SW2. (PAC-SK52ST) (Refer to "9-7. FUNCTION OF SWITCHES, CONNECTORS AND JUMPERS".)	① Disconnection or contact failure of connectors (Outdoor controller circuit board: TH3, TH32, TH7/6 Outdoor power circuit board: CN6) ② Defective thermistor ③ Defective outdoor controller circuit board	① Check connection of connector (TH3, TH32, TH7/6) on the outdoor controller circuit board. Check connection of connector (CN3) on the outdoor power circuit board. Check breaking of the lead wire for TH3, TH32, TH6, TH7, TH8. Refer to "9-6. TEST POINT DIAGRAM". ② Check resistance value of TH3, TH32, TH6, TH7, TH8 or check temperature by microprocessor. (TH3, TH32, TH6, TH7, TH8: Refer to "9-4. HOW TO CHECK THE PARTS".) (SW2 on A-Control Service Tool: Refer to "9-7. FUNCTION OF SWITCHES, CONNECTORS AND JUMPERS".) ③ Replace outdoor controller circuit board. Note: Emergency operation is available in the case of abnormalities of TH3, TH32, TH6 and TH7.	
	Thermistors			
	Symbol		Name	
	TH3, TH32		Thermistor <Liquid>, <Suction>	
	TH6		Thermistor <2-phase pipe>	
TH7		Thermistor <Ambient>		
TH8		Thermistor <Heat sink>		
		Open detection	Short detection	
		-40°F (-40°C) or below	194°F (90°C) or above	
		-40°F (-40°C) or below	194°F (90°C) or above	
		-40°F (-40°C) or below	194°F (90°C) or above	
		-54.4°F (-48°C) or below	215.6°F (102°C) or above	
U5 (4230)	Temperature of heat sink Abnormal if TH8 detects temperature indicated 172.4°F (78°C). TH8: Thermistor <Heat sink>	① The outdoor fan motor is locked. ② Failure of outdoor fan motor ③ Airflow path is clogged. ④ Rise of ambient temperature ⑤ Defective thermistor ⑥ Defective input circuit of outdoor power circuit board ⑦ Failure of outdoor fan drive circuit	①② Check outdoor fan. ③ Check airflow path for cooling. ④ Check if there is something which causes temperature rise around outdoor unit. (Upper limit of ambient temperature is 114.8°F (46°C).) Turn off power and on again to check if U5 is displayed within 30 minutes. If U4 is displayed instead of U5, follow the action to be taken for U4. ⑤ Check resistance value of TH8 or temperature by microprocessor. (TH8: Refer to "9-4. HOW TO CHECK THE PARTS".) (SW2 on A-Control Service Tool: Refer to "9-7. FUNCTION OF SWITCHES, CONNECTORS AND JUMPERS".) ⑥ Replace outdoor power circuit board. ⑦ Replace outdoor controller circuit board.	
	Power module Check abnormality by driving power module if overcurrent is detected. (UF or UP error condition)	① Outdoor stop valve is closed. ② Decrease of power supply voltage ③ Looseness, disconnection or converse of compressor wiring connection ④ Defective compressor ⑤ Defective outdoor power circuit board	① Open stop valve. ② Check facility of power supply. ③ Correct the wiring (U-V-W phase) to compressor. Refer to "9-6. TEST POINT DIAGRAM" (Outdoor power circuit board). ④ Check compressor referring to "9-4. HOW TO CHECK THE PARTS". ⑤ Replace outdoor power circuit board.	
U8 (4400)	Outdoor fan motor Abnormal if rotational frequency of the fan motor is not detected during DC fan motor operation. Fan motor rotational frequency is abnormal if; <ul style="list-style-type: none"> • 100 rpm or below detected continuously for 15 seconds at 68°F (20°C) or more outside air temperature. • 50 rpm or below or 1,500 rpm or more detected continuously for 1 minute. 	① Failure in the operation of the DC fan motor ②③ Failure in the outdoor circuit controller board	① Check or replace the DC fan motor. ② Check the voltage of the outdoor circuit controller board during operation. ③ Replace the outdoor circuit controller board. (When the failure is still indicated even after performing the action ① above.)	

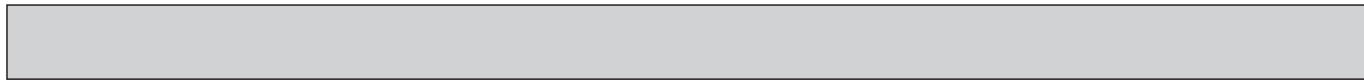

Error code	Abnormal point and detection method	Cause	Judgment and action	
U9 (4220)	Detailed codes	To find out the detail history (latest) about U9 error, turn ON SW2-1, 2-2 and 2-6. Refer to "9-7. FUNCTION OF SWITCHES, CONNECTORS AND JUMPERS".		
	01	Overvoltage error • Increase in DC bus voltage to 760V	① Abnormal increase in power source voltage ② Disconnection of compressor wiring ③ Defective outdoor power circuit board ④ Compressor has a ground fault.	① Check the field facility for the power supply. ② Correct the wiring (U·V·W phase) to compressor. Refer to "9-7. FUNCTION OF SWITCHES, CONNECTORS AND JUMPERS". (Outdoor power circuit board). ③ Replace outdoor power circuit board. ④ Check compressor for electrical insulation. Replace compressor.
	02	Undervoltage error • Instantaneous decrease in DC bus voltage to 350V	① Decrease in power source voltage, instantaneous stop ② Defective 52C drive circuit in outdoor power circuit board ③ Defective outdoor converter circuit board ④ Disconnection or loose connection of rush current protect resistor RS ⑤ Defective rush current protect resistor RS	① Check the field facility for the power supply. ② Replace outdoor power circuit board. ③ Replace outdoor converter circuit board. ④ Check RS wiring. ⑤ Replace RS.
	04	Input current sensor error/ L1-phase open error • Decrease in input current through outdoor unit to 0.1 A only if operation frequency is more than or equal to 40 Hz or compressor current is more than or equal to 6 A.	① Defective input current detection circuit in outdoor power circuit board ② Defective outdoor controller circuit board	① Replace outdoor power circuit board. ② Replace outdoor controller circuit board.
	08	Abnormal power synchronous signal • No input of power synchronous signal to power circuit board • Power synchronous signal of 44 Hz or less, or 65 Hz or more is detected on power circuit board.	① Distortion of power source voltage, noise superimposition. ② Disconnection or loose connection of ground wiring ③ Disconnection or loose connection of CN2 on the outdoor power circuit board /controller circuit board ④ Defective power synchronous signal circuit in outdoor controller circuit board ⑤ Defective power synchronous signal circuit in outdoor power circuit board	① Check the field facility for the power supply. ② Check ground wiring. ③ Check CN2 wiring. ④ Replace outdoor controller circuit board. ⑤ Replace outdoor power circuit board.
	10	PFC error (Overvoltage/ Undervoltage/Overcurrent) • PFC detected any of the following: a) Increase of DC bus voltage as follows: 430 V b) Decrease in PFC control voltage to 13 VDC or lower c) Increase in input current as follows: SA24/36: 62 A peak SA48: 74 A peak	① Abnormal increase in power source voltage ② Decrease in power source voltage, instantaneous stop ③ Disconnection of compressor wiring ④ Misconnection of reactor (DCL) ⑤ Defective outdoor power circuit board ⑥ Defective reactor (DCL) ⑦ Disconnection or loose connection of CN2 on the outdoor power circuit board/controller circuit board	①② Check the field facility for the power supply. ③ Correct the wiring (U·V·W phase) to compressor. Refer to "9-6. TEST POINT DIAGRAM". ④ Correct the wiring (U·V·W phase) or reactor (DCL). ⑤ Replace outdoor power circuit board. ⑥ Replace reactor (DCL). ⑦ Check CN2 wiring.
	80	Input voltage sensor error a) Increase in input voltage to 290 V or higher b) Decrease in input voltage to 162 V or lower c) A short or open circuit is detected in the input voltage detection circuit	① Distortion of power source voltage, noise superimposition ② Disconnection or loose connection of ground wiring ③ Disconnection or loose connection of power supply wiring on the outdoor power circuit board ④ Defective input voltage signal circuit in outdoor power circuit board judgement and action	① Check the field facility for the power supply. ② Check ground wiring. ③ Check power supply wiring. ④ Replace outdoor controller circuit board.

Error code	Abnormal point and detection method	Cause	Judgment and action
Ud (1504)	Overheat protection Abnormal if TH3, condensing temperature T63HS detects 158°F (70°C) or more during compressor operation. TH3: Thermistor <Liquid>	① Defective outdoor fan (fan motor) or short cycle of outdoor unit during cooling operation ② Defective TH3, condensing temperature T63HS ③ Defective outdoor controller board	① Check outdoor unit air passage. ②③ Turn the power off and on again to check the error code. If U4 is displayed, follow the U4 processing direction.
UE (1509)	Abnormal pressure of 63HS Abnormal if 63HS detects 0.1 MPa or less. Detection is inoperative for 3 minutes after compressor starting and 3 minutes after and during defrosting. 63HS: High pressure sensor	① Disconnection or contact failure of connector (63HS) on the outdoor controller circuit board ② Defective pressure sensor ③ Defective outdoor controller circuit board	① Check connection of connector (63HS) on the outdoor controller circuit board. Check breaking of the lead wire for 63HS. ② Check pressure by microprocessor. (Pressure sensor/ 63HS) (SW2: Refer to "9-7. FUNCTION OF SWITCHES, CONNECTORS AND JUMPERS".) ③ Replace outdoor controller board.
UF (4100)	Compressor overcurrent interruption (When compressor is locked) Abnormal if overcurrent of DC bus or compressor is detected within 30 seconds after compressor starts operating.	① Stop valve is closed. ② Decrease of power supply voltage ③ Looseness, disconnection or converse of compressor wiring connection ④ Defective compressor ⑤ Defective outdoor power board ⑥ DIP switch setting difference of outdoor controller circuit board	① Open stop valve. ② Check facility of power supply. ③ Correct the wiring (U·V·W phase) to compressor. Refer to "9-6.TEST POINT DIAGRAM". (Outdoor power circuit board). ④ Check compressor. Refer to "9-4. HOW TO CHECK THE PARTS". ⑤ Replace outdoor power circuit board. ⑥ Check the DIP switch setting of outdoor controller circuit board.
UH (5300)	Current sensor error or input current error • Abnormal if current sensor detects -1.0A to 1.0A during compressor operation. (This error is ignored in the case of test run mode.) • Abnormal if the detected input current or the detected continuous current for 10 second is more than the limit value.	① Disconnection of compressor wiring ② Defective circuit of current sensor on outdoor power circuit board ③ Decrease of power supply voltage ④ Leakage or shortage of refrigerant	① Correct the wiring (U·V·W phase) to compressor. Refer to "9-6.TEST POINT DIAGRAM" (Outdoor power circuit board). ② Replace outdoor power circuit board. ③ Check the facility of power supply. ④ Check leakage of refrigerant.
UP (4210)	Compressor overcurrent interruption Abnormal if overcurrent DC bus or compressor is detected after compressor starts operating for 30 seconds.	① Stop valve of outdoor unit is closed. ② Decrease of power supply voltage ③ Looseness, disconnection or converse of compressor wiring connection ④ Defective fan of indoor/outdoor units ⑤ Short cycle of indoor/outdoor units ⑥ Defective input circuit of outdoor controller board ⑦ Defective compressor ⑧ Defective outdoor power circuit board ⑨ DIP switch setting difference of outdoor controller circuit board	① Open stop valve. ② Check facility of power supply. ③ Correct the wiring (U·V·W phase) to compressor. Refer to "9-6.TEST POINT DIAGRAM" (Outdoor power circuit board). ④ Check indoor/outdoor fan. ⑤ Resolve short cycle. ⑥ Replace outdoor controller circuit board. Note: Before the replacement of the outdoor controller circuit board, disconnect the wiring to compressor from the outdoor power circuit board and check the output voltage among phases, U, V, W, during test run. No defect on board if voltage among phases (U-V, V-W and W-U) is same. Make sure to perform the voltage check with same performing frequency. ⑦ Check compressor. Refer to "9-4. HOW TO CHECK THE PARTS". ⑧ Replace outdoor power circuit board. ⑨ Check the DIP switch setting of outdoor controller circuit board.

Error code	Abnormal point and detection method	Cause	Judgment and action
E0 or E4 (6831 or 6834)	<p>Remote controller transmission error (E0)/signal receiving error (E4)</p> <ul style="list-style-type: none"> Abnormal if main remote controller cannot receive any transmission normally from indoor unit of refrigerant address "0" for 3 minutes. (Error code: E0) Abnormal if indoor controller board cannot receive any data normally from remote controller board or from other indoor controller board for 3 minutes. (Error code: E4) Indoor controller board cannot receive any signal from remote controller for 2 minutes. (Error code: E4) 	<p>① Contact failure at transmission wire of remote controller</p> <p>② Miswiring of remote controller</p> <p>③ Defective transmitting receiving circuit of remote controller</p> <p>④ Defective transmitting receiving circuit of indoor controller board of refrigerant address "0"</p> <p>⑤ Noise has entered into the transmission wire of remote controller.</p>	<p>① Check disconnection or looseness of indoor unit or transmission wire of remote controller.</p> <p>② Check wiring of remote controller.</p> <ul style="list-style-type: none"> Total wiring length: Max. 1640.4 ft (500 m) (Do not use cable with 3 or more cores.) The number of connecting indoor units: Max. 6 units The number of connecting remote controller: Max. 1 unit <p>If the cause of trouble is not in above ①–②,</p> <p>③ Diagnose remote controller (PAC-IF011B-E only).</p> <p>a) When "OK" is displayed, remote controllers have no problem. Turn the power off, and on again to check. If abnormality occurs again, replace indoor controller board.</p> <p>b) When "NG" is displayed, replace remote controller.</p> <p>c) When "E3" or "00-66" is displayed, noise may be causing abnormality.</p> <p>Note: If the unit is not normal after replacing indoor controller board in group control, indoor controller board of address "0" may be abnormal. For the controllers other than PAC-IF011B-E, refer to Installation Manual or Service Handbook of the indoor unit.</p>
E1 or E2 (6201 or 6202)	<p>Remote controller control board</p> <ul style="list-style-type: none"> Abnormal if data cannot be normally read from the nonvolatile memory of the remote controller control board. (Error code: E1) Abnormal if the clock function of remote controller cannot be normally operated. (Error code: E2) 	<p>① Defective remote controller</p>	<p>① Replace remote controller.</p>
E3 or E5 (6832 or 6833)	<p>Remote controller transmission error (E3)/signal receiving error (E5)</p> <ul style="list-style-type: none"> Abnormal if remote controller could not find blank of transmission path for 6 seconds and could not transmit. (Error code: E3) Remote controller receives transmitted data at the same time, compares the data, and when detecting it, judges different data to be abnormal 30 continuous times. (Error code: E3) Abnormal if indoor controller board could not find blank of transmission path.(Error code: E5) Indoor controller board receives transmitted data at the same time, compares the data, and when detecting it, judges different data to be abnormal 30 continuous times. (Error code: E5) 	<p>① Duplication of refrigerant address</p> <p>② Defective transmitting receiving circuit of remote controller</p> <p>③ Defective transmitting receiving circuit of indoor controller board</p> <p>④ Noise has entered into transmission wire of remote controller.</p>	<p>① The address changes to a separate setting.</p> <p>②–④ Diagnose remote controller (PAC-IF011B-E only).</p> <p>a) When "OK" is displayed, remote controllers have no problem. Turn the power off, and on again to check. When becoming abnormal again, replace indoor controller board.</p> <p>b) When "NG" is displayed, replace remote controller.</p> <p>c) When "E3" or "00-66" is displayed, noise may be causing abnormality.</p> <p>Note: For the controllers other than PAC-IF011B-E, refer to Installation Manual or Service Handbook of the indoor unit.</p>

Error code	Abnormal point and detection method	Cause	Judgment and action
E6 (6840)	Indoor/outdoor unit communication error (Signal receiving error) <ul style="list-style-type: none"> Abnormal if indoor controller board could not receive any signal normally for 6 minutes after turning the power on. Abnormal if indoor controller board could not receive any signal normally for 3 minutes. Consider the unit as abnormal under the following condition. When 2 or more indoor units are connected to an outdoor unit, indoor controller board could not receive a signal for 3 minutes from outdoor controller circuit board, a signal which allows outdoor controller circuit board to transmit signals. 	<ul style="list-style-type: none"> ① Contact failure, short circuit or miswiring (reversed wiring) of indoor/outdoor unit connecting wire. ② Defective transmitting receiving circuit of outdoor controller circuit board. ③ Defective transmitting receiving circuit of indoor controller circuit board. ④ Noise has entered into indoor/outdoor unit connecting wire. ⑤ High pressure (High pressure switch 63H operated) or High compressor temperature (Thermal protector TRS operated) ⑥ Defective fan motor ⑦ Defective rush current resistor of outdoor power circuit board 	<p>Check LED display on outdoor controller circuit board. (Connect A-Control service tool (PAC-SK52ST)) Refer to EA-EC item if LED displays EA-AC.</p> <ul style="list-style-type: none"> ① Check disconnecting or looseness of indoor/outdoor unit connecting wire of indoor unit or outdoor unit. Check all the units in the case of twin/triple/quadruple indoor unit. ②-⑤ Turn the power off, wait 10 minutes and on again to check. If abnormality occurs again, replace indoor controller board or outdoor controller circuit board. <p>Note: Other indoor controller board may have defect in the case of twin/triple/quadruple indoor unit system.</p> <ul style="list-style-type: none"> ⑥ Turn the power off, and detach fan motor from connector (CNF1, 2). Then turn the power on again. If abnormality is not displayed, replace fan motor. If abnormality is displayed, replace outdoor controller circuit board. ⑦ Check the rush current resistor on outdoor power circuit board with tester. If open is detected, replace the power circuit board.
E7 (6842)	Indoor/outdoor unit communication error (Transmitting error) Abnormal if "1" receiving is detected 30 times continuously though indoor controller board has transmitted "0".	<ul style="list-style-type: none"> ① Defective transmitting receiving circuit of indoor controller board ② Noise has entered into power supply ③ Noise has entered into outdoor control wire 	<ul style="list-style-type: none"> ①-③ Turn the power off, and on again to check. If abnormality occurs again, replace indoor controller board.
E8 (6840)	Indoor/outdoor unit communication error (Signal receiving error) (Outdoor unit) Abnormal if outdoor controller circuit board could not receive anything normally for 3 minutes.	<ul style="list-style-type: none"> ① Contact failure of indoor/outdoor unit connecting wire ② Defective communication circuit of outdoor controller circuit board ③ Defective communication circuit of indoor controller board ④ Noise has entered into indoor/outdoor unit connecting wire. 	<ul style="list-style-type: none"> ① Check disconnection or looseness of indoor/outdoor unit connecting wire of indoor or outdoor units. ②-④ Turn the power off, and on again to check. Replace indoor controller board or outdoor controller circuit board if abnormality is displayed again.
E9 (6841)	Indoor/outdoor unit communication error (Transmitting error) (Outdoor unit) <ul style="list-style-type: none"> Abnormal if "0" receiving is detected 30 times continuously though outdoor controller circuit board has transmitted "1". Abnormal if outdoor controller circuit board could not find blank of transmission path for 3 minutes. 	<ul style="list-style-type: none"> ① Indoor/outdoor unit connecting wire has contact failure. ② Defective communication circuit of outdoor controller circuit board ③ Noise has entered power supply. ④ Noise has entered indoor/outdoor unit connecting wire. 	<ul style="list-style-type: none"> ① Check disconnection or looseness of indoor/outdoor unit connecting wire. ②-④ Turn the power off, and on again to check. Replace outdoor controller circuit board if abnormality is displayed again.
EF	Non defined error code This code is displayed when non defined error code is received.	<ul style="list-style-type: none"> ① Noise has entered transmission wire of remote controller. ② Noise has entered indoor/outdoor unit connecting wire. ③ Outdoor unit is not inverter models. 	<ul style="list-style-type: none"> ①② Turn the power off, and on again to check. Replace indoor controller board or outdoor controller circuit board if abnormality is displayed again. ③ Replace outdoor unit with inverter type outdoor unit.

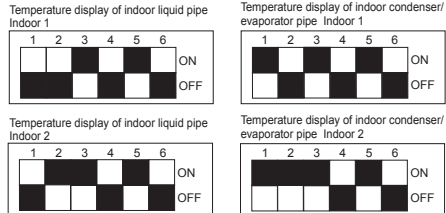



Error code	Abnormal point and detection method	Cause	Judgment and action
Ed (0403)	Serial communication error <ul style="list-style-type: none"> Abnormal if serial communication between outdoor controller circuit board and outdoor power circuit board is defective. 	① Breaking of wire or contact failure of connector CN2 between the outdoor controller circuit board and the outdoor power circuit board ② Breaking of wire or contact failure of connector CN4 between the outdoor controller circuit board and the outdoor power circuit board ③ Defective communication circuit of outdoor power circuit board ④ Defective communication circuit of outdoor controller circuit board for outdoor power circuit board	①② Check connection of each connector CN2 and CN4 between the outdoor controller circuit board and the outdoor power circuit board. ③ Replace outdoor power circuit board. ④ Replace outdoor controller circuit board.
P8 (1110)	Pipe temperature <Heating mode> When 10 seconds have passed after the compressor starts operation and the hot adjustment mode has finished, the unit is detected as abnormal when condenser/ evaporator pipe temperature is not in heating range within 20 minutes. Note 3: It takes at least 27 minutes to detect abnormality. Note 4: It excludes the period of defrosting (Detection restarts when defrosting mode is over) Heating range : 37.4°F (3°C) ≤ (Condenser/ Evaporator temperature (T63HS)- room temperature(TH1))	① Slight temperature difference between indoor room temperature and pipe <liquid or condenser/ evaporator> temperature thermistor <ul style="list-style-type: none"> Shortage of refrigerant Disconnected holder of pipe <liquid or condenser/ evaporator> thermistor Defective refrigerant circuit ② Converse connection of extension pipe (on plural unit connection) ③ Converse wiring of indoor/outdoor unit connecting wire (on plural unit connection) ④ Defective detection of indoor room temperature and pipe <condenser/evaporator> temperature thermistor ⑤ Stop valve is not opened completely.	①-④ Check pipe <liquid or condenser/evaporator> temperature with room temperature display on remote controller and outdoor controller circuit board. Pipe <liquid or condenser/ evaporator> temperature display is indicated by setting SW2 of outdoor controller circuit board as follows. (Conduct temperature check with outdoor controller circuit board after connecting 'A-Control Service Tool (PAC-SK52ST)')  A-Control Service Tool SW2 setting ②③ Check converse connection of extension pipe or converse wiring of indoor/outdoor unit connecting wire. ⑤ Check the stop valve is opened completely.

9-3. TROUBLESHOOTING OF PROBLEMS

Phenomena	Factor	Countermeasure
1. Remote controller display does not work.	① 12 VDC is not supplied to remote controller. ② 12-15 VDC is supplied to remote controller, however, no display is indicated. <ul style="list-style-type: none"> "Please Wait" is not displayed. "Please Wait" is displayed. 	① Check LED2 on indoor controller board. <ol style="list-style-type: none"> When LED2 is lit: Check the remote controller wiring for breaking or contact failure. When LED2 is blinking: Check short circuit of remote controller wiring. When LED2 is not lit: Refer to No.3 below. ② Check the following. <ul style="list-style-type: none"> Failure of remote controller if "Please Wait" is not displayed Refer to No.2 below if "Please Wait" is displayed.



Phenomena	Factor	Countermeasure
2. "Please Wait" display is remained on the remote controller.	① At longest 2 minutes after the power supply "Please Wait" is displayed to start up. ② Communication error between the remote controller and indoor unit ③ Communication error between the indoor and outdoor unit ④ Outdoor unit protection device connector is open.	① Normal operation ② Self-diagnosis of remote controller ③ "Please Wait" is displayed for 6 minutes at most in the case of indoor/outdoor unit communication error. Check LED3 on indoor controller board. (1) When LED3 is not blinking. Check indoor/outdoor connecting wire for miswiring. (Converse wiring of S1 and S2, or break of S3 wiring.) (2) When LED3 is blinking. Indoor/outdoor connecting wire is normal. ④ Check LED display on outdoor controller circuit board. Refer to "9-6.TEST POINT DIAGRAM". Check protection device connector (63H) for contact failure.
3. When pressing the remote controller operation switch, the OPERATION display is appeared but it will be turned off soon.	① After cancelling to select function from the remote controller, the remote controller operation switch will not be accepted for approx. 30 seconds.	① Normal operation
4. Remote controller display works normally and the unit performs cooling operation, however, the capacity cannot be fully obtained.	① Refrigerant shortage ② Filter clogging	① If refrigerant leaks, discharge temperature rises and LEV opening increases. Inspect leakage by checking the temperature and opening. Check pipe connections for gas leakage. ② Clean the filter of water piping.
5. Remote controller display works normally and the unit performs heating operation, however, the capacity cannot be fully obtained.	① Linear expansion valve fault Opening cannot be adjusted well due to linear expansion valve fault. ② Refrigerant shortage ③ Lack of insulation for refrigerant piping ④ Filter clogging ⑤ Bypass circuit of outdoor unit fault	① Discharge temperature and indoor heat exchanger temperature does not rise. Inspect the failure by checking discharging pressure. Replace linear expansion valve. ② If refrigerant leaks, discharge temperature rises and LEV opening increases. Inspect leakage by checking the temperature and opening. Check pipe connections for gas leakage. ③ Check the insulation. ④ Clean the filter of water piping. ⑤ Check refrigerant system during operation.
6. ① For 3 minutes after temperature adjuster turns off, the compressor will not start operating even if temperature adjuster is turned on. ② For 3 minutes after temperature adjuster turns on, the compressor will not stop operating even if temperature adjuster is turned off. (Compressor stops operating immediately when turning off by the remote controller.)	①② Normal operation (For protection of compressor)	①② Normal operation
7. The compressor does not work after breaker switched on.	① Normal operation (For protection of compressor) The unit might not run, in order to protect the compressor, when the following two conditions holds: 1.The unit was not supplied power for a while, e.g. at the first use of the unit; 2. Ambient and compressor surface are below freezing temperature. It may last up to 12 hours until the unit runs.	① Start operating after 12 hours of power-on.

Phenomena	Countermeasure
A flowing water sound or occasional hissing sound is heard.	<ul style="list-style-type: none"> These sounds can be heard when refrigerant and/or water is (are) flowing in the indoor unit or refrigerant pipe, or when the refrigerant and/or water is (are) chugging.
Water does not heat or cool well.	<ul style="list-style-type: none"> Clean the filter of water piping. (Flow is reduced when the filter is dirty or clogged.) Check the temperature adjustment and adjust the set temperature. Make sure that there is plenty of space around the outdoor unit.
Water is dripping or vapor is emitted from the outdoor unit.	<ul style="list-style-type: none"> During cooling mode, water may form and drip from the cool pipes and joints. During heating mode, water may form and drip from the heat exchanger of outdoor unit. During defrosting mode, water on the heat exchanger of outdoor unit evaporates and water vapor may be emitted.
The operation indicator does not appear in the remote controller display.	<ul style="list-style-type: none"> Turn on the power switch. "●" will appear in the remote controller display*.
"  " appears in the remote controller display.*	<ul style="list-style-type: none"> During external signal control, "" appears in the remote controller display and FTC operation cannot be started or stopped using the remote controller.
When restarting the outdoor unit soon after stopping it, it does not operate even though the ON/OFF button is pressed.*	<ul style="list-style-type: none"> Wait approximately 3 minutes. (Operation has stopped to protect the outdoor unit.)
FTC operates without the ON/OFF button being pressed.*	<ul style="list-style-type: none"> Is the on timer set? Press the ON/OFF button to stop operation. Is the FTC connected to a external signal? Consult the concerned people who control the FTC. Does "" appear in the remote controller display? Consult the concerned people who control the FTC. Has the auto recovery feature from power failures been set? Press the ON/OFF button to stop operation.
FTC stops without the ON/OFF button being pressed.*	<ul style="list-style-type: none"> Is the off timer set? Press the ON/OFF button to restart operation. Is the FTC connected to a central remote controller? Consult the concerned people who control the FTC. Does "" appear in the remote controller display? Consult the concerned people who control the FTC.
Remote controller timer operation cannot be set.*	<ul style="list-style-type: none"> Are timer settings invalid? If the timer can be set, (WEEKLY) , (SIMPLE) , or (AUTO OFF) appears in the remote controller display.
"Please Wait" appears in the remote controller display.	<ul style="list-style-type: none"> The initial settings are being performed. Wait approximately 3 minutes. If the remote controller is not only for FTC, change it.
A error code appears in the remote controller display.	<ul style="list-style-type: none"> The protection devices have operated to protect the FTC and outdoor unit. Do not attempt to repair this equipment by yourself. Turn off the power switch immediately and consult your dealer. Be sure to provide the dealer with the model name and information that appeared in the remote controller display.

*PAC-IF011B-E only

- If the unit cannot be operated properly after test run, refer to the following table to find the cause.

Symptom		Cause
Wired remote controller	LED 1, 2 (PCB in outdoor unit)	
Please Wait	For about 2 minutes after power-on After LED 1, 2 are lit, LED 2 is turned off, then only LED 1 is lit. (Correct operation)	<ul style="list-style-type: none"> For about 2 minutes following power-on, operation of the remote controller is not possible due to system startup. (Correct operation)
Please Wait → Check code	Subsequent to about 2 minutes after power-on	<ul style="list-style-type: none"> Connector for the outdoor unit's protection device is not connected. Reverse or open phase wiring for the outdoor unit's power terminal block (L1, L2)
Display messages do not appear even when operation switch is turned ON (operation lamp does not light up).		
	<ul style="list-style-type: none"> Only LED 1 is lit. → LED 1 blinks twice, LED 2 blinks once. 	<ul style="list-style-type: none"> Incorrect wiring between FTC and outdoor (incorrect polarity of S1, S2, S3) Remote controller wire short

Note: Operation is not possible for about 30 seconds after cancellation of function selection. (Correct operation)

For description of each LED (LED1, 2, 3) provided on the FTC, refer to the following table.

LED1 (power for microprocessor)	Indicates whether control power is supplied. Make sure that this LED is always lit.
LED2 (power for remote controller)	Indicates whether power is supplied to the remote controller. This LED lights only in the case of the FTC which is connected to the outdoor unit refrigerant addresses "0".
LED3 (communication between FTC and outdoor units)	Indicates state of communication between the FTC and outdoor units. Make sure that this LED is always blinking.

Symptoms: “Please Wait” is kept being displayed on the remote controller.





Diagnosis flow	Cause	Inspection method and troubleshooting
<pre> graph TD Start[Check the display time of "Please Wait" after turning on the main power.] --> D1{How long is "Please Wait" kept being displayed on the remote controller?} D1 -- "2 minutes or less" --> C1[• "Please Wait" will be displayed during the startup diagnosis after turning on the main power.] D1 -- "2 to 6 minutes" --> D2{Are any check codes displayed on the remote controller?} D2 -- NO --> C1 D2 -- YES --> S2[Check the LED display of the outdoor controller circuit board.] S2 --> D3{Are any check codes displayed on the LED?} D3 -- YES --> C2[• Miswiring of indoor/outdoor connecting wire • Breaking of indoor/outdoor connecting wire (S3) • Defective indoor controller board • Defective outdoor controller circuit board] D3 -- NO --> C3[• Defective indoor controller board • Defective remote controller] </pre>	<ul style="list-style-type: none"> • “Please Wait” will be displayed during the startup diagnosis after turning on the main power. • Miswiring of indoor/outdoor connecting wire • Breaking of indoor/outdoor connecting wire (S3) • Defective indoor controller board • Defective outdoor controller circuit board • Defective indoor controller board • Defective remote controller 	<ul style="list-style-type: none"> • Normal. The startup diagnosis will be over in around 2 minutes. • Refer to “Self-diagnosis action table” in order to solve the trouble. • In the case of communication errors, the display of remote controller may not match the LED display of the outdoor unit.

Symptoms: Nothing is displayed on the remote controller. ①

LED display of the indoor controller board
 LED1: ○
 LED2: ○
 LED3: ○



Diagnosis flow	Cause	Inspection method and troubleshooting
<pre> graph TD A[Check the voltage between S1 and S2 on the terminal block of the indoor unit which is used to connect the indoor unit and the outdoor unit.] --> B{198 to 253 VAC?} B -- YES --> C[Check the fuses on the indoor controller circuit board.] B -- NO --> D[Check the voltage among L1 and L2 on the terminal block (TB1) of the outdoor power circuit board.] D --> E{198 to 253 VAC?} E -- NO --> F[• Troubles concerning power supply] E -- YES --> G[Check the voltage between S1 and S2 on the terminal block (TB1) of the outdoor unit which is used to connect the indoor unit and the outdoor unit.] G --> H{198 to 253 VAC?} H -- NO --> I[• Bad wiring of the outdoor controller board • The fuses on the outdoor controller circuit board are blown.] H -- YES --> J[• Bad wiring of the outdoor controller board • The fuses on the outdoor controller circuit board are blown.] C --> K[• The fuses on the indoor controller circuit board are blown. • Defective indoor controller board] I --> L[• Check the wiring of the outdoor unit. • Check if the wiring is bad. Check if the fuses are blown. The fuses on the outdoor controller circuit board will be blown when the indoor/outdoor connecting wire short-circuits.] J --> M[• Check if miswiring, breaking or poor contact is causing this problem. Indoor/outdoor connecting wire is polarized 3-core type. Connect the indoor unit and the outdoor unit by wiring each pair of S1, S2 and S3 on the both side of indoor/outdoor terminal blocks.] K --> N[• Check if the fuses are blown. • Replace the indoor controller board.] </pre>	<ul style="list-style-type: none"> • Troubles concerning power supply • Bad wiring of the outdoor controller board • The fuses on the outdoor controller circuit board are blown. • Bad wiring of the outdoor controller board • The fuses on the outdoor controller circuit board are blown. • The fuses on the indoor controller circuit board are blown. • Defective indoor controller board 	<ul style="list-style-type: none"> • Check the power wiring to the outdoor unit. • Check the breaker. • Check the wiring of the outdoor unit. • Check if the wiring is bad. Check if the fuses are blown. The fuses on the outdoor controller circuit board will be blown when the indoor/outdoor connecting wire short-circuits. • Check if miswiring, breaking or poor contact is causing this problem. Indoor/outdoor connecting wire is polarized 3-core type. Connect the indoor unit and the outdoor unit by wiring each pair of S1, S2 and S3 on the both side of indoor/outdoor terminal blocks. • Check if the fuses are blown. • Replace the indoor controller board.

Symptoms: Nothing is displayed on the remote controller. ②

LED display of the indoor controller board
 LED1: 
 LED2: 
 LED3:  or 

Diagnosis flow	Cause	Inspection method and troubleshooting
<p>Check the voltage between S1 and S2 on the terminal block of the indoor unit which is used to connect the indoor unit and the outdoor unit.</p> <p>198 to 253 VAC?</p> <p>NO → Check the looseness or disconnection of the indoor/outdoor connecting wire.</p> <p>YES → Check the status of the indoor controller board LED3 display.</p> <p>Not lighting. → Check the looseness or disconnection of the indoor/outdoor connecting wire.</p> <p>Blinking. → Are there looseness or disconnection of the indoor/outdoor connecting wire?</p> <p>NO → Check the refrigerant address of the outdoor unit. (SW1-3 to 1-6)</p> <p>Is the refrigerant address "0"?</p> <p>NO → Normal Only the unit which has the refrigerant address "0" supplies power to the remote controller</p> <p>YES → Check the LED display of the outdoor unit after turning on the main power again.</p> <p>Is anything displayed?</p> <p>NO → Defective outdoor controller circuit board</p> <p>YES → Is "EA" or "Eb" displayed?</p> <p>NO → Defective outdoor controller circuit board</p> <p>YES → Is "E8" displayed?</p> <p>YES → Defective outdoor controller circuit board</p> <p>NO → Can the unit be restarted?</p> <p>Can all the indoor unit be operated?</p> <p>NO → Defective indoor controller board</p> <p>YES → Influence of electromagnetic noise</p> <p>Check the voltage between S2 and S3 on the terminal block of the outdoor unit.</p> <p>17 to 28 VDC?</p> <p>NO → Defective outdoor power circuit board</p> <p>YES → Defective indoor power board</p>	<ul style="list-style-type: none"> • Breaking or poor contact of the indoor/outdoor connecting wire • Normal Only the unit which has the refrigerant address "0" supplies power to the remote controller • Defective outdoor controller circuit board • Defective outdoor controller circuit board • Defective indoor controller board • Influence of electromagnetic noise • Defective outdoor power circuit board • Defective indoor power board 	<ul style="list-style-type: none"> • Fix the breaking or poor contact of the indoor/outdoor connecting wire. • Set the refrigerant address to "0". In the case of the multiple outdoor units control, recheck the refrigerant address again. • Replace the outdoor controller circuit board. • Replace the outdoor controller circuit board. • Replace the indoor controller board of the indoor unit which does not operate. • Not abnormal. There may be the influence of electromagnetic noise. Check the transmission wire and get rid of the causes. • Replace the outdoor power circuit board. • Replace the indoor power board.

Symptoms: Nothing is displayed on the remote controller. ③

LED display of the indoor controller board
 LED1: 
 LED2:  or 
 LED3: —

Diagnosis flow	Cause	Inspection method and troubleshooting
<p>Check the voltage of the terminal block (TB6) of the remote controller.</p> <p>10 to 16 VDC?</p> <p>YES</p> <p>NO</p> <p>Check the status of the LED2.</p> <p>Lighting</p> <p>Blinking</p> <p>Check the status of the LED2 after disconnecting the remote controller wire from the indoor unit.</p> <p>Check the status of the LED2.</p> <p>Lighting</p> <p>Blinking</p>	<ul style="list-style-type: none"> • Defective remote controller • Breaking or poor contact of the remote controller wire • The remote controller wire short-circuits • Defective indoor controller board 	<ul style="list-style-type: none"> • Replace the remote controller. • Check if there is breaking or poor contact of the remote controller wire. Check the voltage of the remote controller wire. If it is not between 10 and 16 VDC, the indoor controller board must be defective. • Check if the remote controller wire is short-circuited. • Replace the indoor controller board.

9-4. HOW TO CHECK THE PARTS

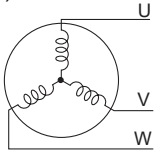
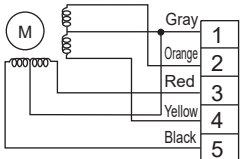
Parts name	Checkpoints														
Thermistor (TH3) <Liquid> Thermistor (TH4) <Discharge> Thermistor (TH6) <2-phase pipe> Thermistor (TH7) <Ambient> Thermistor (TH8) <Heat sink> Thermistor (TH32) <Suction> Thermistor (TH33) <Comp. surface>	Disconnect the connector then measure the resistance with a multimeter. (At the ambient temperature 50°F to 86°F (10°C to 30°C)) <table border="1" style="margin-top: 10px;"> <thead> <tr> <th></th> <th>Normal</th> <th>Abnormal</th> </tr> </thead> <tbody> <tr> <td>TH4 TH33</td> <td>160 to 410 kΩ</td> <td rowspan="3">Open or short</td> </tr> <tr> <td>TH3 TH6 TH7 TH32</td> <td>4.3 to 9.6 kΩ</td> </tr> <tr> <td>TH8</td> <td>39 to 105 kΩ</td> </tr> </tbody> </table>		Normal	Abnormal	TH4 TH33	160 to 410 kΩ	Open or short	TH3 TH6 TH7 TH32	4.3 to 9.6 kΩ	TH8	39 to 105 kΩ				
	Normal	Abnormal													
TH4 TH33	160 to 410 kΩ	Open or short													
TH3 TH6 TH7 TH32	4.3 to 9.6 kΩ														
TH8	39 to 105 kΩ														
Fan motor (MF1)	Refer to the next page.														
Solenoid valve coil <4-way valve> (21S4)	Measure the resistance between the terminals with a multimeter. (At the ambient temperature 68°F (20°C)) <table border="1" style="margin-top: 10px;"> <thead> <tr> <th>Normal</th> <th>Abnormal</th> </tr> </thead> <tbody> <tr> <td>1435 ± 150 Ω</td> <td>Open or short</td> </tr> </tbody> </table>	Normal	Abnormal	1435 ± 150 Ω	Open or short										
Normal	Abnormal														
1435 ± 150 Ω	Open or short														
Motor for compressor (MC) 	Measure the resistance between the terminals with a multimeter. (Winding temperature 68°F (20°C)) <table border="1" style="margin-top: 10px;"> <tbody> <tr> <td>WUZ-SA24/36NMZ-U1</td> <td>Abnormal</td> </tr> <tr> <td>0.943 Ω</td> <td>Open or short</td> </tr> <tr> <td>WUZ-SA48NMZ-U1</td> <td>Abnormal</td> </tr> <tr> <td>0.315 Ω</td> <td>Open or short</td> </tr> </tbody> </table>	WUZ-SA24/36NMZ-U1	Abnormal	0.943 Ω	Open or short	WUZ-SA48NMZ-U1	Abnormal	0.315 Ω	Open or short						
WUZ-SA24/36NMZ-U1	Abnormal														
0.943 Ω	Open or short														
WUZ-SA48NMZ-U1	Abnormal														
0.315 Ω	Open or short														
Linear expansion valve (LEV-A/LEV-B/LEV-C) 	Disconnect the connector then measure the resistance with a multimeter. (Winding temperature 68°F (20°C)) <table border="1" style="margin-top: 10px;"> <thead> <tr> <th colspan="4">Normal</th> <th>Abnormal</th> </tr> </thead> <tbody> <tr> <td>Gray - Black</td> <td>Gray - Red</td> <td>Gray - Yellow</td> <td>Gray - Orange</td> <td rowspan="2">Open or short</td> </tr> <tr> <td colspan="4" style="text-align: center;">46 ± 3 Ω</td> </tr> </tbody> </table>	Normal				Abnormal	Gray - Black	Gray - Red	Gray - Yellow	Gray - Orange	Open or short	46 ± 3 Ω			
Normal				Abnormal											
Gray - Black	Gray - Red	Gray - Yellow	Gray - Orange	Open or short											
46 ± 3 Ω															

Check method of DC fan motor (fan motor/outdoor controller circuit board)

① Notes

- High voltage is applied to the connector (CNF1) for the fan motor. Pay attention to the service.
- Do not pull out the connector (CNF1) for the motor with the power supply on.
(It causes trouble of the outdoor controller circuit board and fan motor.)

② Self check

Symptom: The outdoor fan cannot rotate.

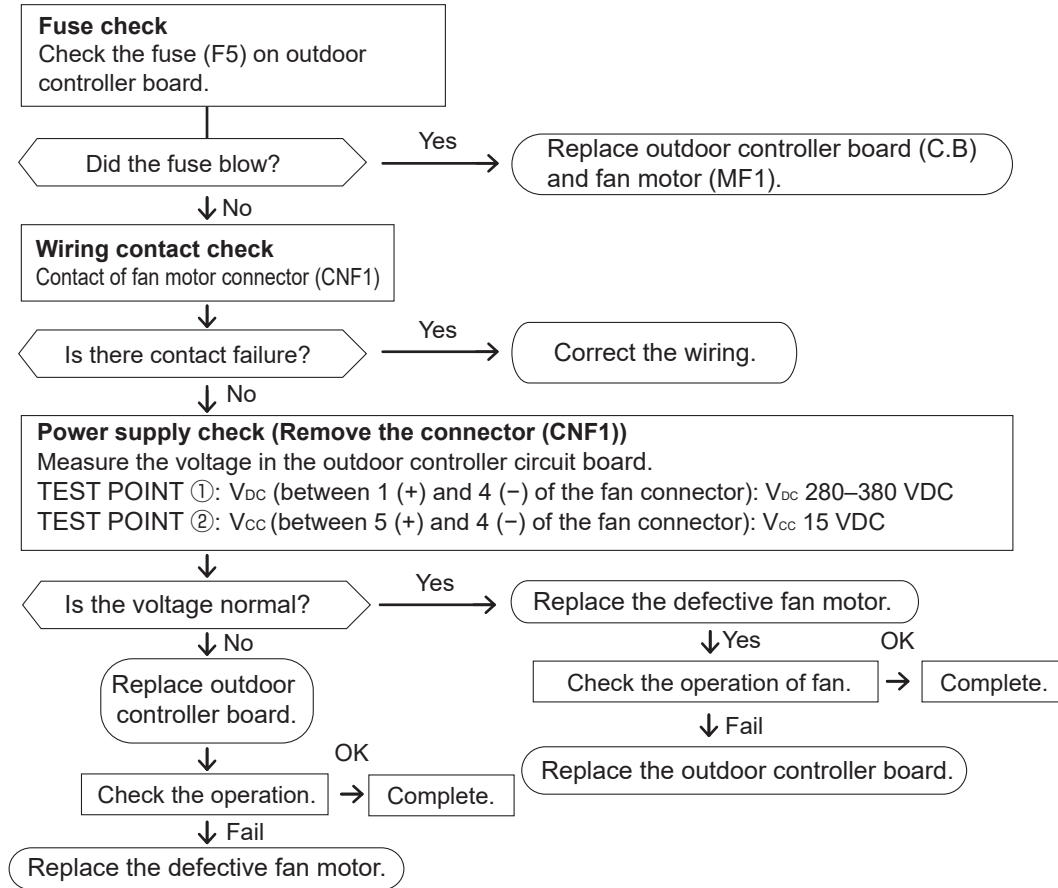

9-5. HOW TO CHECK THE COMPONENTS

<HIGH PRESSURE SENSOR>

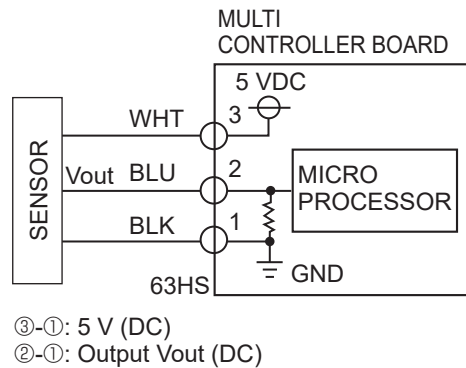
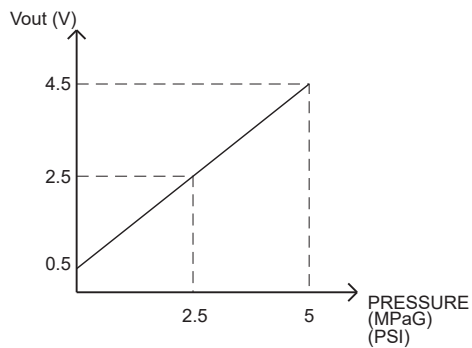

<Thermistor feature chart>

Low temperature thermistors

- Thermistor <Liquid> (TH3)
- Thermistor <2-phase pipe> (TH6)
- Thermistor <Ambient> (TH7)
- Thermistor <Suction> (TH32)

Thermistor R0 = 15 kΩ ± 3 %
 B constant = 3480 ± 1 %

$$t (^{\circ}\text{C}): R_t = 15 \exp\left\{3480 \left(\frac{1}{273+t} - \frac{1}{273}\right)\right\}$$

$$T (^{\circ}\text{F}): R_T = 15 \exp\left\{3480 \left(\frac{1}{273+(T-32)/1.8} - \frac{1}{273}\right)\right\}$$

32°F [0°C]	15 kΩ	86°F [30°C]	4.3 kΩ
50°F [10°C]	9.6 kΩ	104°F [40°C]	3.0 kΩ
68°F [20°C]	6.3 kΩ		
77°F [25°C]	5.2 kΩ		

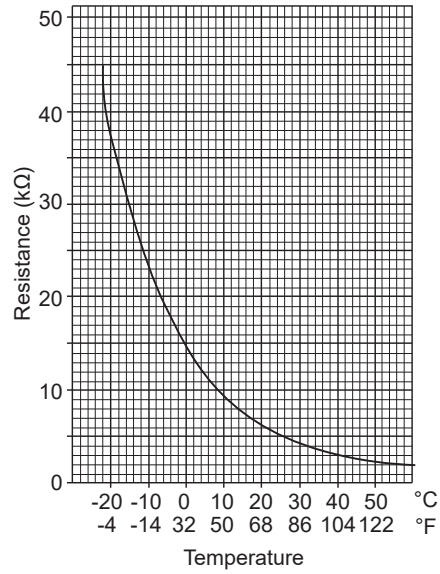

Medium temperature thermistor

- Thermistor <Heat sink> (TH8)

Thermistor R50 = 17 kΩ ± 2 %
 B constant = 4150 ± 3 %

$$t (^{\circ}\text{C}): R_t = 17 \exp\left\{4150 \left(\frac{1}{273+t} - \frac{1}{323}\right)\right\}$$

$$T (^{\circ}\text{F}): R_T = 17 \exp\left\{4150 \left(\frac{1}{273+(T-32)/1.8} - \frac{1}{323}\right)\right\}$$

32°F [0 °C]	180 kΩ
77°F [25 °C]	50 kΩ
122°F [50 °C]	17 kΩ
158°F [70 °C]	8 kΩ
194°F [90 °C]	4 kΩ

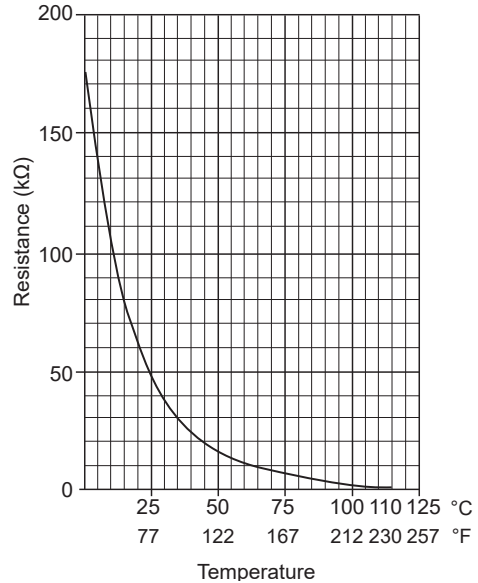

High temperature thermistors

- Thermistor <Discharge> (TH4)
- Thermistor <Comp. surface> (TH33)

Thermistor R120 = 7.465 kΩ ± 2 %
 B constant = 4057 ± 2 %

$$t (^{\circ}\text{C}): R_t = 7.465 \exp\left\{4057 \left(\frac{1}{273+t} - \frac{1}{393}\right)\right\}$$

$$T (^{\circ}\text{F}): R_T = 7.465 \exp\left\{4057 \left(\frac{1}{273+(T-32)/1.8} - \frac{1}{393}\right)\right\}$$

68°F [20°C]	250 kΩ	158°F [70°C]	34 kΩ
86°F [30°C]	160 kΩ	176°F [80°C]	24 kΩ
104°F [40°C]	104 kΩ	194°F [90°C]	17.5 kΩ
122°F [50°C]	70 kΩ	212°F [100°C]	13.0 kΩ
140°F [60°C]	48 kΩ	230°F [110°C]	9.8 kΩ

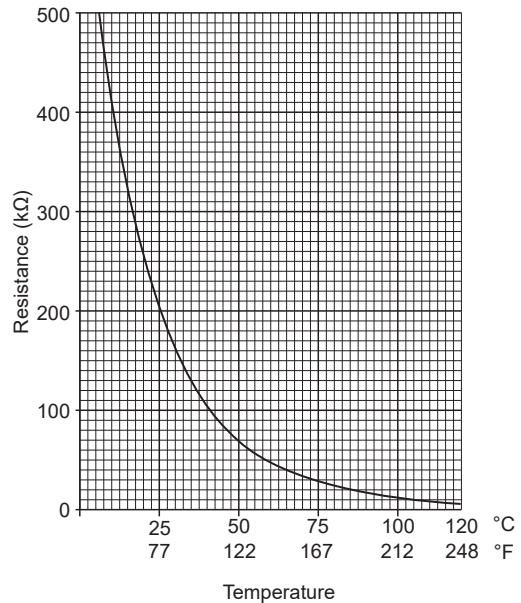

Linear expansion valve

(1) Operation summary of the linear expansion valve

- The linear expansion valve opens/closes through stepping motor after receiving the pulse signal from the outdoor controller board.
 - The valve position can be changed in proportion to the number of the pulse signal.
- <Connection between the outdoor controller board and the linear expansion valve>

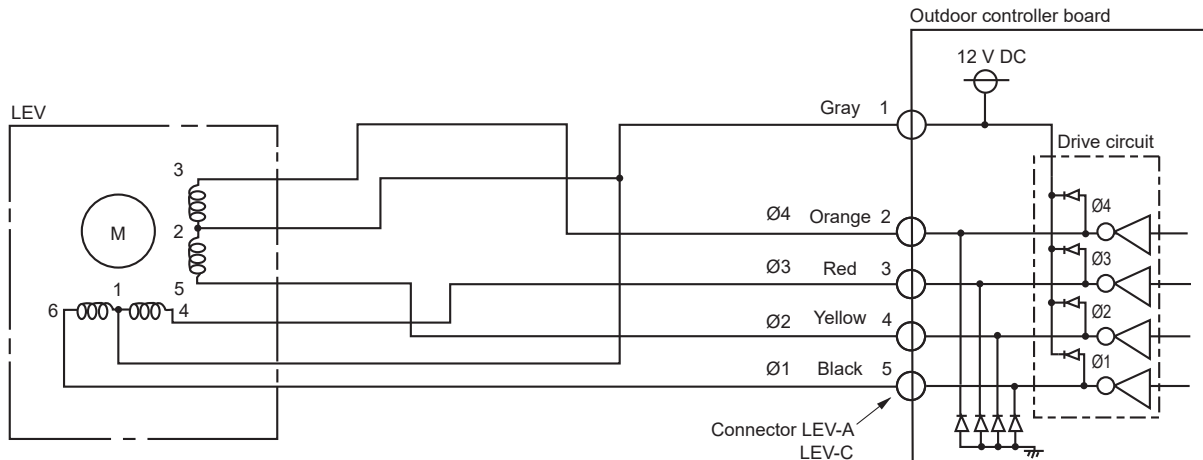

<Output pulse signal and the valve operation>

Output (Phase)	Output							
	1	2	3	4	5	6	7	8
Ø1	ON	ON	OFF	OFF	OFF	OFF	OFF	ON
Ø2	OFF	ON	ON	ON	OFF	OFF	OFF	OFF
Ø3	OFF	OFF	OFF	ON	ON	ON	OFF	OFF
Ø4	OFF	OFF	OFF	OFF	OFF	ON	ON	ON

The output pulse shifts in the following order.

Opening a valve : 8 → 7 → 6 → 5 → 4 → 3 → 2 → 1 → 8

Closing a valve : 1 → 2 → 3 → 4 → 5 → 6 → 7 → 8 → 1

- When the linear expansion valve operation stops, all output phases become OFF.

(2) Linear expansion valve operation

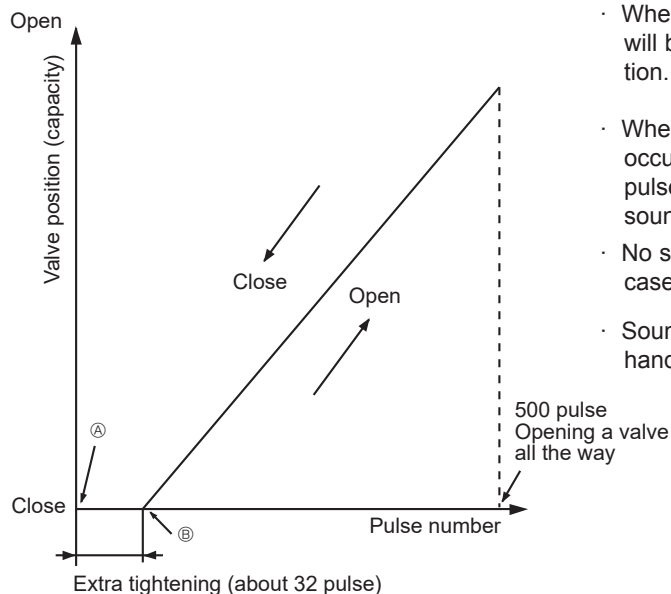

- When the power is turned on, 700 pulse closing the valve signal will be sent till it goes to ① point in order to define the valve position. (The pulse signal is being sent for about 20 seconds.)
- When the valve moves smoothly, there is no sound or vibration occurring from the linear expansion valve : however, when the pulse number moves from ② to ① or when the valve is locked, sound can be heard.
- No sound is heard when the pulse number moves from ② to ① in case coil is burnt out or motor is locked by the open-phase.
- Sound can be detected by placing the ear against the screw driver handle while putting the screw driver to the linear expansion valve.

(3) How to attach and detach the coil of linear expansion valve

<Composition>

The linear expansion valve is separable into the main body and the coil as shown in the diagram below.

LEV Type 1.

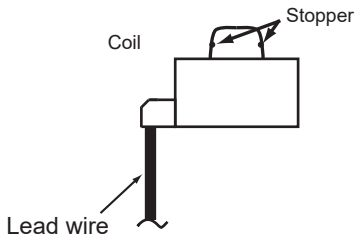

LEV Type 2.

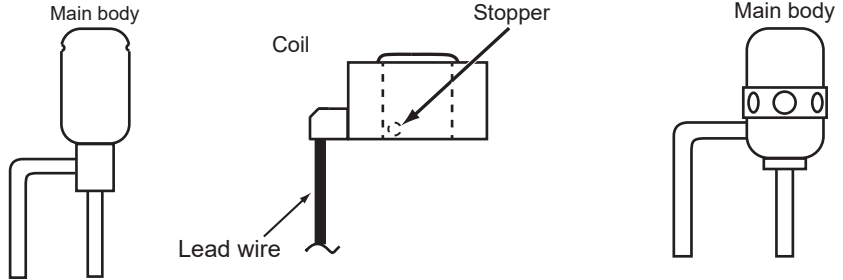

<How to detach the coil>

Hold the lower part of the main body (shown as A) firmly so that the main body does not move and detach the coil by pulling it upward.

Be sure to detach the coil holding main body firmly. Otherwise pipes can bend due to stress.

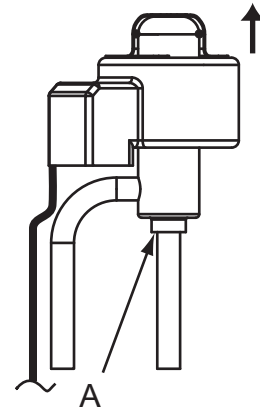

<How to attach the coil>

Hold the lower part of the main body (shown as A) firmly so that the main body does not move and attach the coil by inserting it downward into the main body. Then securely attach the coil stopper to main body. (At this time, be careful that stress is not added to lead wire and main body is not wound by lead wire.) If the stopper is not firmly attached to main body, coil may be detached from the main body and that can cause defective operation of linear expansion valve.

To prevent piping stress, be sure to attach the coil holding the main body of linear expansion valve firmly. Otherwise pipe may break.

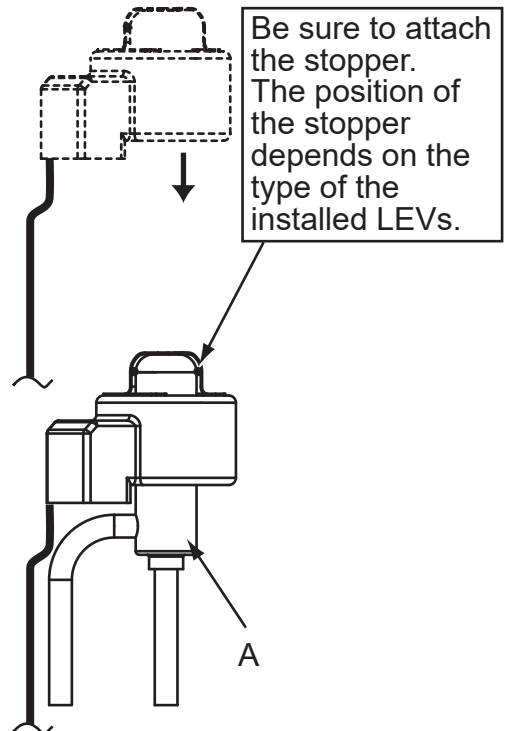

9-6. TEST POINT DIAGRAM Outdoor controller circuit board

<CAUTION> TEST POINT① is high voltage.

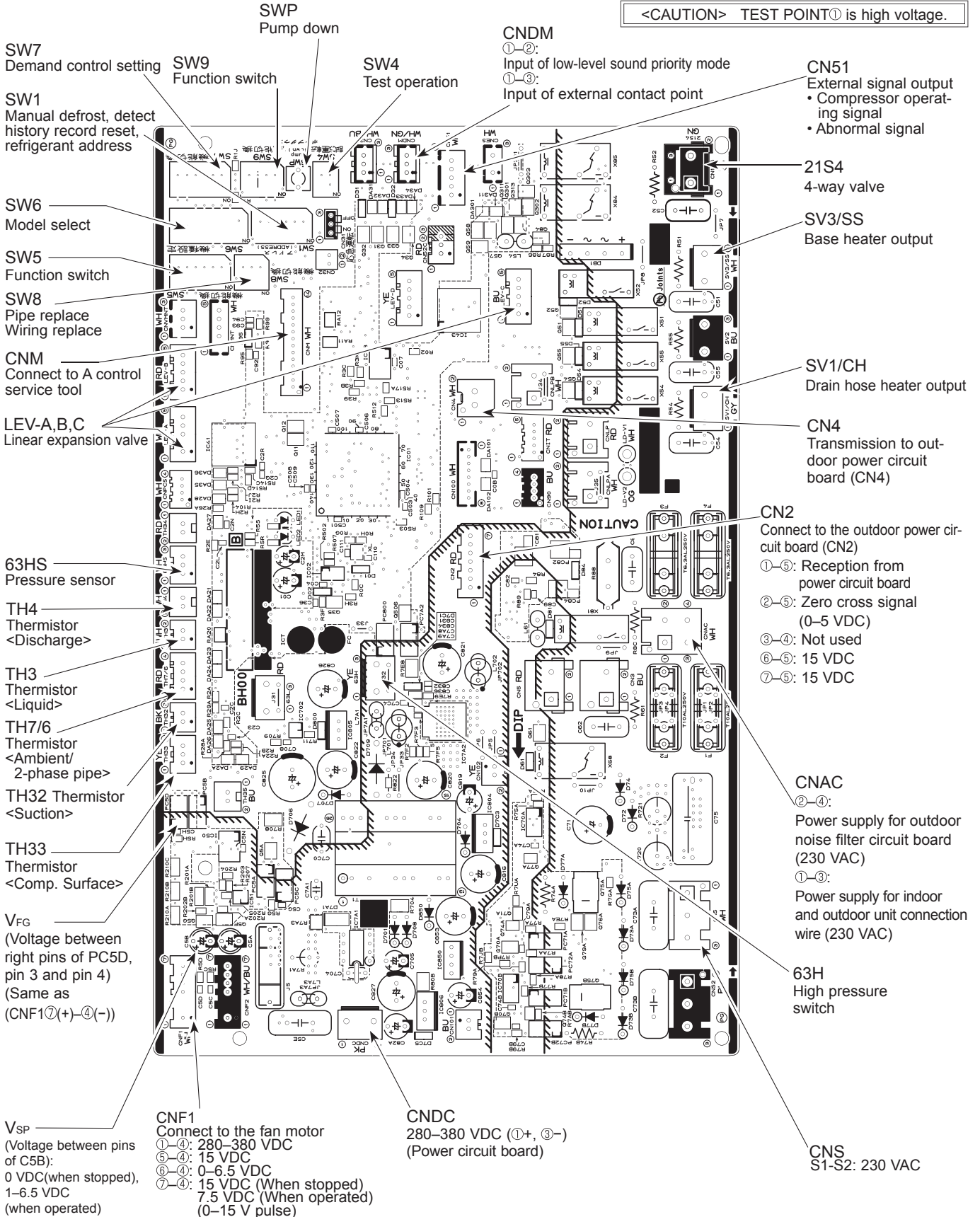

Outdoor noise filter circuit board
WUZ-SA48NMZ-U1

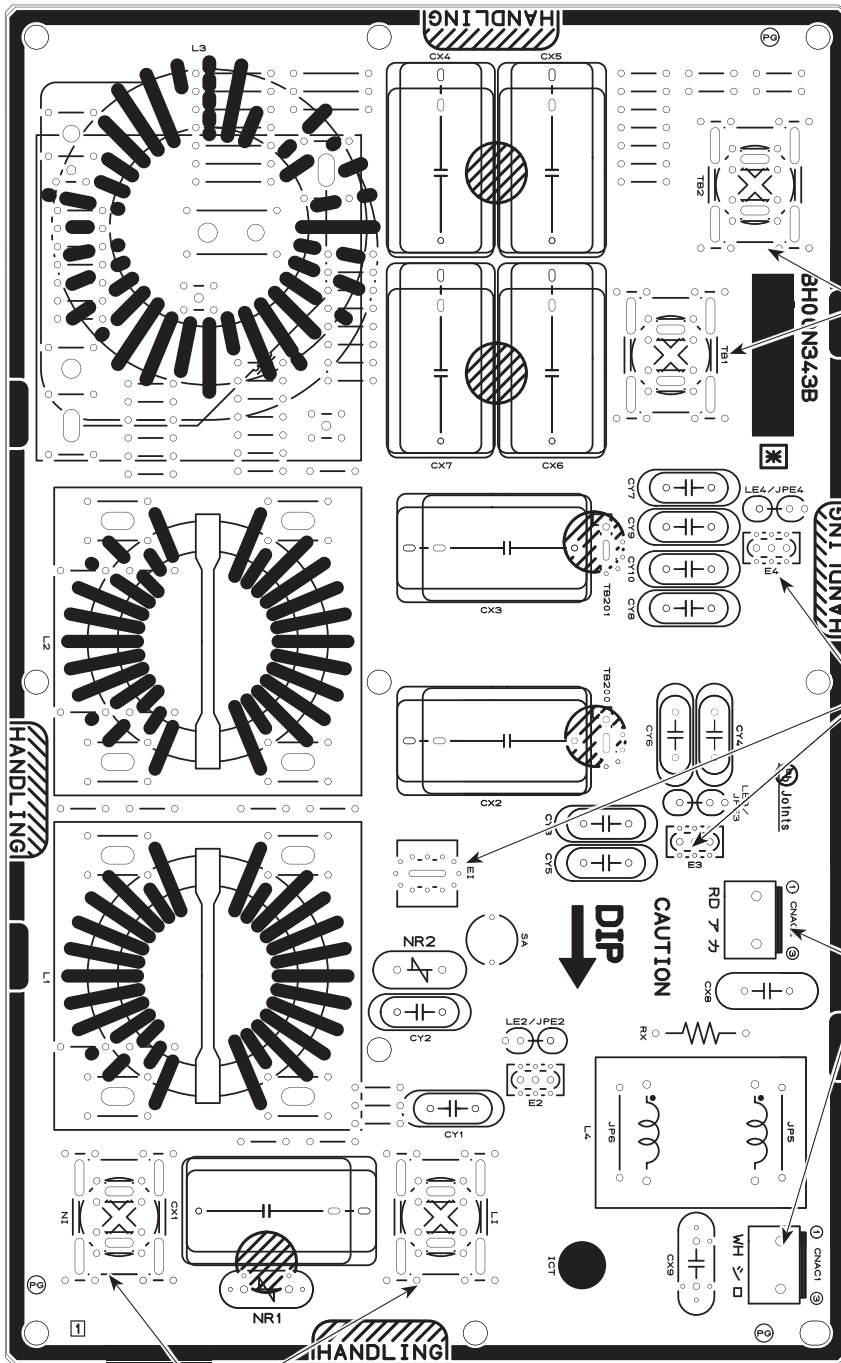

TB1, TB2
 POWER SUPPLY
 Voltage of 230 VAC is
 output
 (Connect to the outdoor
 power circuit board
 (TB3, TB4))

E1, E3, E4
 Connect to the earth

CNAC1, CNAC2
 230 VAC
 (Connect to the outdoor controller
 circuit board)

LI, NI
 POWER SUPPLY
 Voltage of 230 VAC is input
 (Connect to the terminal block (TB1))

Outdoor power circuit board

WUZ-SA24NMZ-U1

WUZ-SA36NMZ-U1

Brief check for power module

If they are short-circuited, they are broken.

Measure the resistance at the following points (connectors, etc.).

1. Check for power module

① Check diode circuit

R - P1 S - P1 R - N1 S - N1

② Check IGBT circuit

P2 - L1 P2 - L2 P2 - L3 N2 - L1 N2 - L2 N2 - L3

③ Check inverter circuit

P3 - U, P3 - V, P3 - W, N3 - U, N3 - V, N3 - W

Note: The marks R, S, L1, L2, L3, P1, N1, U, V, and W shown in the diagram are not actually printed on the board.

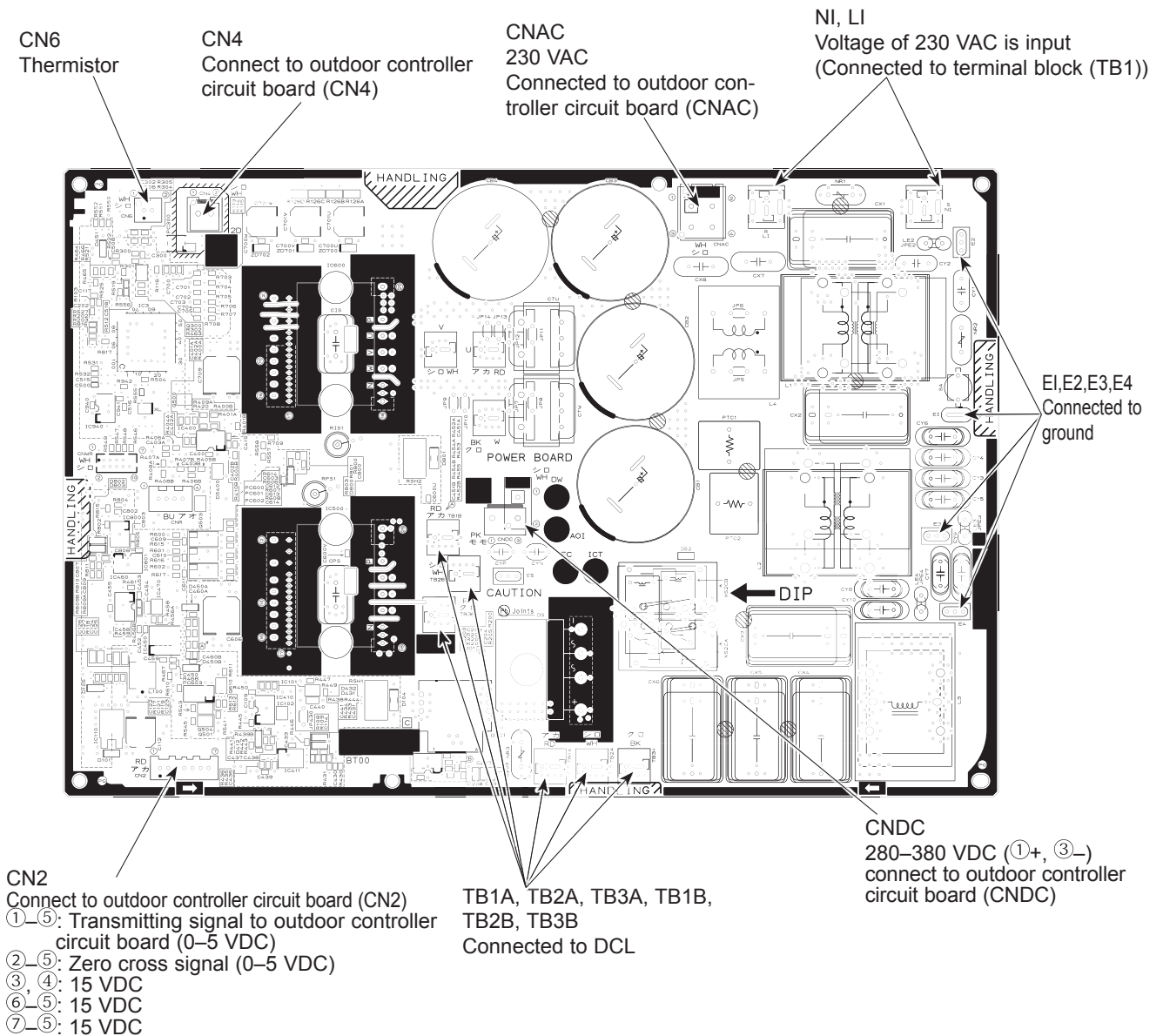

Outdoor power circuit board WUZ-SA48NMZ-U1

Brief check for power module

If they are short-circuited, they are broken.

Measure the resistance at the following points (connectors, etc.).

1. Check for power module

① Check diode circuit

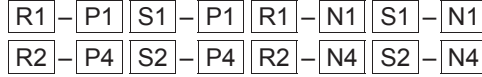

② Check IGBT circuit



③ Check inverter circuit



Note: The marks **R**, **S**, **L1**, **L2**, **L3**, **P1**, **N1**, **U**, **V**, and **W** shown in the diagram are not actually printed on the board.

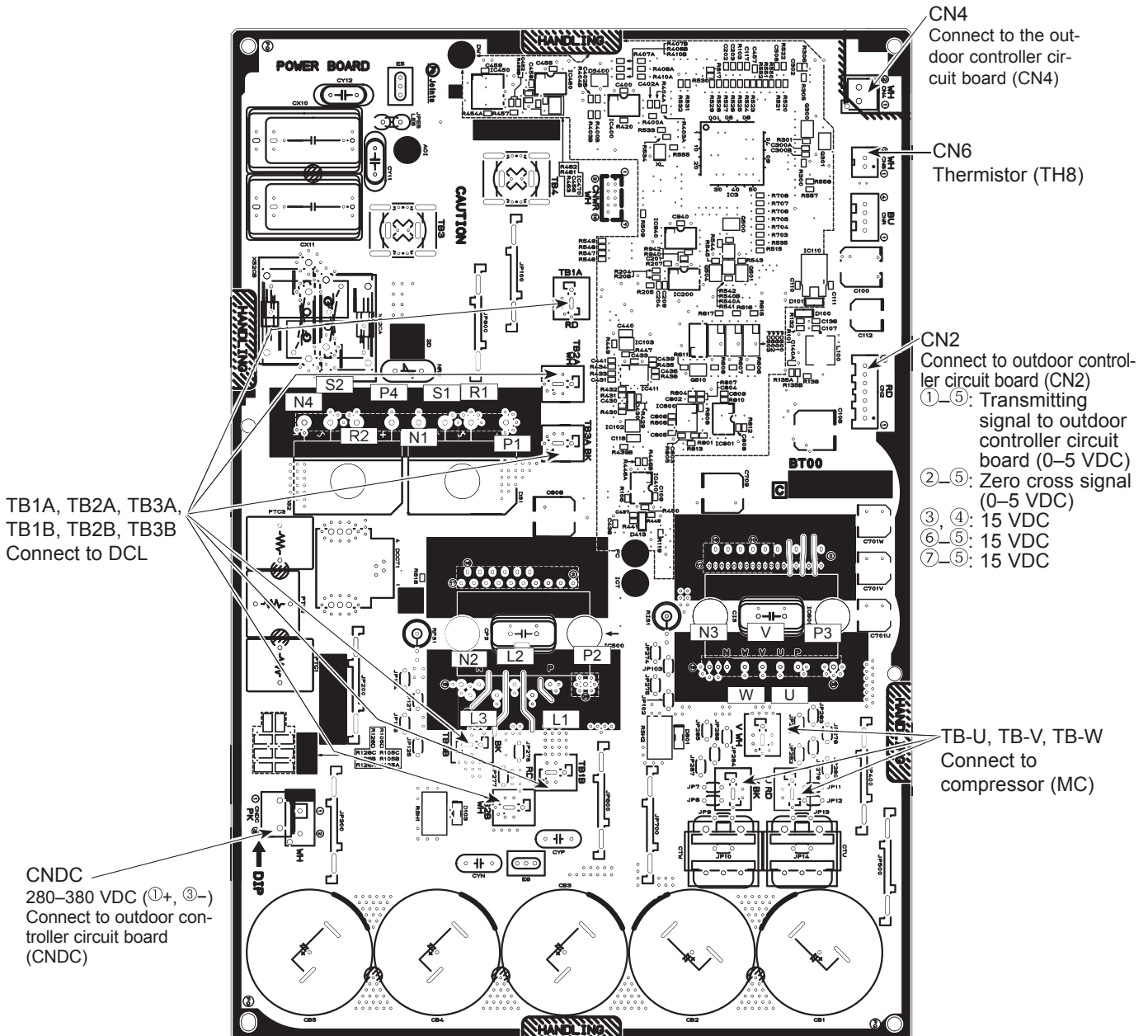

TB1A, TB2A, TB3A,
TB1B, TB2B, TB3B
Connect to DCL

CNDC
280-380 VDC (①+, ③-)
Connect to outdoor controller circuit board (CNDC)

CN4
Connect to the outdoor controller circuit board (CN4)

CN6
Thermistor (TH8)





CN2
Connect to outdoor controller circuit board (CN2)
①-⑤: Transmitting signal to outdoor controller circuit board (0-5 VDC)
②-⑤: Zero cross signal (0-5 VDC)
③, ④: 15 VDC
⑥-⑤: 15 VDC
⑦-⑤: 15 VDC

TB-U, TB-V, TB-W
Connect to compressor (MC)

9-7. FUNCTION OF SWITCHES, CONNECTORS AND JUMPERS

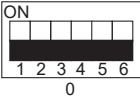
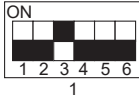
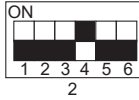
Function of switches

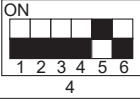
The black square (■) indicates a switch position.

Type of Switch	Switch	No.	Function	Action by switch operation		Effective timing														
				ON	OFF															
DIP switch	SW1	1	No function	—	—	—														
		2	Abnormal history clear	Clear	Normal	off or operating														
		3	Refrigerant address setting		0	When power supply is ON														
		4			1															
		5			2															
		6			3															
	4		4																	
	5		5																	
	SW4	1	No function	—	—	—														
		2	No function	—	—	—														
SW8	1	Use of existing pipe	Used	Not used	Always															
	2	No function	—	—	—															
	3	Separate indoor/outdoor unit power supplies	Used	Not used	When power supply is ON															
Push switch	SWP	Pump down	Start	Normal	Under suspension															
DIP switch	SW5	1	No function	—	—	—														
		2	Power failure automatic recovery*1	Auto recovery	No auto recovery	When power supply is ON														
		3,4	No function	—	—	—														
		5	Capacity operation	Passive mode	Active mode	When power supply is ON														
		6	DHW operation	ECO mode	Quick mode	When power supply is ON														
	SW7*2	1	Mode select*3	Demand function	Low noise mode	When power supply is ON														
		2	Service check function*4	Backup data	Normal	Always														
		3	No function	—	—	—														
		4,5	No function	—	—	—														
	SW9	6	Defrost setting	For high humidity	Normal	Always														
		1	No function	—	—	—														
		2	No function	—	—	—														
3,4		Starting Ambient temp. of flash injection	<table border="1" data-bbox="686 1319 1173 1468"> <thead> <tr> <th>SW9-3</th> <th>SW9-4</th> <th>Ambient temp.</th> </tr> </thead> <tbody> <tr> <td>OFF</td> <td>OFF</td> <td>≤ 21.2°F (-6°C) (Initial setting)</td> </tr> <tr> <td>OFF</td> <td>ON</td> <td>≤ 26.6°F (-3°C)</td> </tr> <tr> <td>ON</td> <td>OFF</td> <td>≤ 32°F (0°C)</td> </tr> <tr> <td>ON</td> <td>ON</td> <td>≤ 37.4°F (3°C)</td> </tr> </tbody> </table>		SW9-3	SW9-4	Ambient temp.	OFF	OFF	≤ 21.2°F (-6°C) (Initial setting)	OFF	ON	≤ 26.6°F (-3°C)	ON	OFF	≤ 32°F (0°C)	ON	ON	≤ 37.4°F (3°C)	Always
SW9-3		SW9-4	Ambient temp.																	
OFF	OFF	≤ 21.2°F (-6°C) (Initial setting)																		
OFF	ON	≤ 26.6°F (-3°C)																		
ON	OFF	≤ 32°F (0°C)																		
ON	ON	≤ 37.4°F (3°C)																		
DIP switch	SW6	1	Model select	Refer to "6. WIRING DIAGRAM".																
		2																		
		3																		
		4																		
		5																		
		6																		
		7																		
		8																		

*1 "Power failure automatic recovery" can be set by either remote controller or this DIP SW. If one of them is set to ON, "Auto recovery" activates. Please set "Auto recovery" basically by remote controller because all units do not have DIP SW. Please refer to the indoor unit installation manual.

*2 Please do not use SW7-2,4,5,6 usually. The conditions of use may cause problems.

*3 SW7-1 is setting change over of Demand. It is effective only in the case of external input. (Local wiring is necessary. Refer to the next page: Special function.)

*4 This function displays the backup data when errors occurred. (Last 4 data at the maximum)

SPECIAL FUNCTIONS

9.7.1. Low noise mode (on-site modification) (Fig. 9-7-1)

1. Using the CNDM connector (Option)

By performing the following modification, operation noise of the outdoor unit can be reduced.

The low noise mode will be activated when a commercially available timer or the contact input of an ON/OFF switch is added to the CNDM connector (option) on the control board of the outdoor unit.

• The ability varies according to the outdoor temperature and conditions, etc.

- ① Complete the circuit as shown when using the external input adapter (PAC-SC36NA-E). (Option)
- ② SW7-1 (Outdoor unit control board): OFF
- ③ SW1 ON: Low noise mode
SW1 OFF: Normal operation

2. Using remote controller

Refer to the indoor unit installation manual.

9.7.2. Demand function (on-site modification) (Fig. 9-7-2)

By performing the following modification, energy consumption can be reduced to 0–100% of the normal consumption.

The demand function will be activated when a commercially available timer or the contact input of an ON/OFF switch is added to the CNDM connector (option) on the control board of the outdoor unit.

- ① Complete the circuit as shown when using the external input adapter (PAC-SC36NA-E). (Option)
- ② By setting SW7-1 on the control board of the outdoor unit, the energy consumption (compared to the normal consumption) can be limited as shown below.

	SW7-1	SW2	SW3	Energy consumption
Demand function	ON	OFF	OFF	100%
		ON	OFF	75%
		ON	ON	50%
		OFF	ON	0% (Stop)

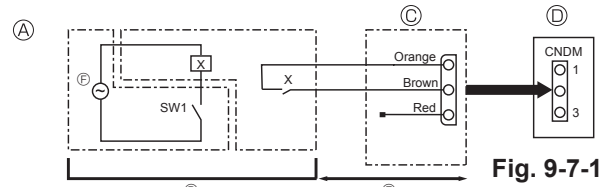

- ① Circuit diagram example (low noise mode)
 ② On-site arrangement
 ③ External input adapter (PAC-SC36NA-E)
 X: Relay
 ④ Outdoor unit control board
 ⑤ Max. 32.8 ft (10 m)
 ⑥ Power supply for relay

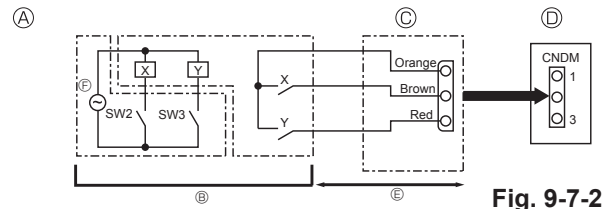

- ① Circuit diagram example (Demand function)
 ② On-site arrangement
 X, Y: Relay
 ③ External input adapter (PAC-SC36NA-E)
 ④ Outdoor unit control board
 ⑤ Max. 32.8 ft (10 m)
 ⑥ Power supply for relay

<Display function of inspection for outdoor unit>

The blinking patterns of both LED1 (green) and LED2 (red) indicate the types of abnormality when it occurs. Types of abnormality can be indicated in details by connecting an optional part "A-Control Service Tool (PAC-SK52ST)" to connector CNM on outdoor controller board.

[Display]

(1) Normal condition

Unit condition	Outdoor controller board		A-Control Service Tool	
	LED1 (Green)	LED2 (Red)	Error code	Indication of the display
When the power is turned on	Lit	Lit	— ⇄ —	Alternately blinking display
When unit stops	Lit	Not lit	00, etc.	Operation mode
When compressor is warming up	Lit	Not lit	08, etc.	
When unit operates	Lit	Lit	C5, H7, etc.	

(2) Abnormal condition

Indication		Error			Detailed reference page
Outdoor controller board		Contents	Check code*	Inspection method	
LED1 (Green)	LED2 (Red)				
1 blinking	2 blinking	Connector(63H) is open.	F5	① Check if connector on the outdoor controller board is not disconnected. ② Check continuity of pressure switch by multimeter.	P.20
2 blinking	1 blinking	Miswiring of indoor/outdoor unit connecting wire, excessive number of indoor units (2 units or more)	—	① Check if indoor/outdoor connecting wire is connected correctly. ② Check if 4 or more indoor units are connected to outdoor unit.	P.20 (EA)
		Miswiring of indoor/outdoor unit connecting wire (converse wiring or disconnection)	—	③ Check if noise entered into indoor/outdoor connecting wire or power supply.	P.20 (Eb)
		Startup time over	—	④ Re-check error by turning off power, and on again.	P.20 (EC)
2 blinking	2 blinking	Indoor/outdoor unit communication error (signal receiving error) is detected by indoor unit.	E6	① Check if indoor/outdoor connecting wire is connected correctly. ② Check if noise entered into indoor/outdoor connecting wire or power supply.	P.26
		Indoor/outdoor unit communication error (transmitting error) is detected by indoor unit.	E7	③ Check if noise entered into indoor/outdoor controller board.	P.26
		Indoor/outdoor unit communication error (signal receiving error) is detected by outdoor unit.	—	④ Re-check error by turning off power, and on again.	P.26 (E8)
		Indoor/outdoor unit communication error (transmitting error) is detected by outdoor unit.	—		P.26 (E9)
3 blinking		Remote controller signal receiving error is detected by remote controller.	E0	① Check if connecting wire of indoor unit or remote controller is connected correctly. ② Check if noise entered into transmission wire of remote controller.	P.25
		Remote controller transmitting error is detected by remote controller.	E3	③ Re-check error by turning off power, and on again.	P.25
		Remote controller signal receiving error is detected by indoor unit.	E4		P.25
		Remote controller transmitting error is detected by indoor unit.	E5		P.25
4 blinking		Error code is not defined.	EF	① Check if noise entered into transmission wire of remote controller. ② Check if noise entered into indoor/outdoor connecting wire. ③ Re-check error by turning off power, and on again.	P.26
		Incorrect connection	EE	① Connect I/F or FTC to the unit.	P.20
5 blinking		Serial communication error <Communication between outdoor controller board and outdoor power board>	Ed	① Check if connector (CN4) on outdoor controller board and outdoor power board is not disconnected.	P.27

* Error code displayed on remote controller

** Refer to service manual for indoor unit.

Indication		Error			
Outdoor controller board		Contents	Check code*	Inspection method	Detailed reference page
LED1 (Green)	LED2 (Red)				
3 blinking	1 blinking	Abnormality of discharge temperature (TH4) and Comp. surface temperature (TH33)	U2	① Check if stop valves are open. ② Check if connectors (TH4, LEV-A) on outdoor controller board are not disconnected. ③ Check if unit is filled with specified amount of refrigerant. ④ Measure resistance values among terminals on indoor valve and outdoor linear expansion valve using a multimeter.	P.21
	2 blinking	Abnormal high pressure (High pressure switch 63H operated.)	U1	① Check if indoor/outdoor units have a short cycle on their air ducts. ② Check if connector(63H) on outdoor controller board is not disconnected. ③ Check if heat exchanger and filter are not dirty. ④ Measure resistance values among terminals on linear expansion valve using a multimeter.	P.21
	3 blinking	Abnormality of outdoor fan motor rotational speed	U8	① Check the outdoor fan motor. ② Check if connector (TH3) (63HS) on outdoor controller board is disconnected.	P.22
		Protection from overheat operation (TH3)	Ud		P.24
	4 blinking	Compressor overcurrent breaking(Startup locked)	UF	① Check if stop valves are open. ② Check looseness, disconnection, and converse connection of compressor wiring. ③ Measure resistance values among terminals on compressor using a multimeter. ④ Check if outdoor unit has a short cycle on its air duct. ⑤ Check leakage of refrigerant.	P.24
		Compressor overcurrent breaking	UP		P.24
		Abnormality of current sensor (P.B.)	UH		P.24
		Abnormality of power module	U6		P.22
	5 blinking	Open/short of outdoor thermistors (TH4, TH33)	U3	① Check if connectors (TH3, TH32, TH4, TH33 and TH7/6) on outdoor controller board and connector (CN3) on outdoor power board are not disconnected. ② Measure resistance value of outdoor thermistors.	P.21
		Open/short of outdoor thermistors (TH3, TH32, TH6, TH7 and TH8)	U4		P.22
6 blinking	Abnormality of heat sink temperature	U5	① Check if indoor/outdoor units have a short cycle on their air ducts. ② Measure resistance value of outdoor thermistor(TH8).	P.22	
7 blinking	Abnormality of voltage	U9	① Check looseness, disconnection, and converse connection of compressor wiring. ② Measure resistance value among terminals on compressor using a multimeter. ③ Check if power supply voltage decreases. ④ Check the wiring of CN52C. ⑤ Check the wiring of CNAF.	P.23	
4 blinking	1 blinking	Abnormality of room temperature thermistor (TH1)	P1	① Check if connectors on indoor controller board are not disconnected. ② Measure resistance value of indoor thermistors.	**
		Abnormality of pipe temperature thermistor /Liquid (TH2)	P2		**
		Abnormality of tank temperature thermistor	P9		**
	4 blinking	Abnormality of pipe temperature	P8	① Check if indoor thermistors(TH2 and T63HS) are not disconnected from holder. ② Check if stop valve is open. ③ Check converse connection of extension pipe. (on plural unit connection) ④ Check if indoor/outdoor connecting wire is connected correctly. (on plural unit connection)	P.27

* Error code displayed on remote controller

** Refer to service manual for indoor unit.

<Outdoor unit operation monitor function>

[When optional part "A-Control Service Tool (PAC-SK52ST)" is connected to outdoor controller board (CNM)]

By controlling SW2 on the 'A-Control Service Tool', a 2-digit number or code is displayed on the digital indicator LED1 to indicate the operating status and the meaning of the error code.

Operation indicator SW2: Indicator change of self-diagnosis



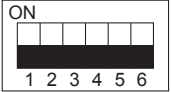
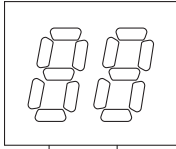
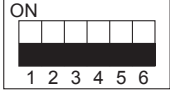

The black square (■) indicates a switch position.

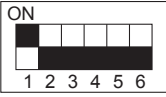
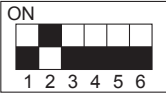
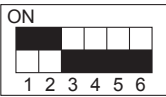
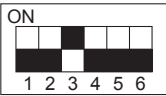
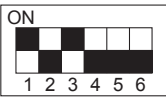
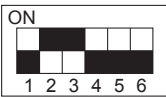
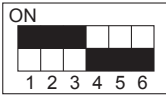
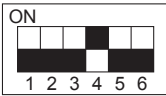
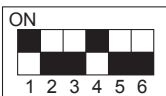
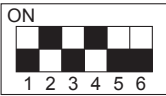
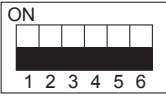
SW2 setting	Display detail	Explanation for display	Unit																																																															
	<p><Digital indicator LED1 working details> (Be sure that 1 to 6 on SW2 are set to OFF.)</p> <p>(1) Display when the power supply ON When the power supply ON, the displays blink alternately. Wait for 4 minutes at the longest.</p> <p>(2) When the display lights (Normal operation)</p> <p>① Operation mode display</p> <div style="display: flex; align-items: center; justify-content: space-around;"> <div style="text-align: center;">  <p>LED1</p> </div> <div style="text-align: center;">  <p>SW2 (Initial setting)</p> </div> </div> <div style="display: flex; justify-content: space-around; margin-top: 20px;"> <div style="width: 45%;"> <p>The tens digit: Operation mode</p> <table border="1" style="width:100%; border-collapse: collapse;"> <thead> <tr> <th>Display</th> <th>Operation Model</th> </tr> </thead> <tbody> <tr><td>O</td><td>OFF / FAN</td></tr> <tr><td>C</td><td>COOL / DRY *</td></tr> <tr><td>H</td><td>HEAT</td></tr> <tr><td>d</td><td>DEFROST</td></tr> </tbody> </table> <p>* C5 is displayed during replacement operation.</p> <p>② Display during error postponement Postponement code is displayed when compressor stops due to the work of protection device. Postponement code is displayed while error is being postponed.</p> </div> <div style="width: 45%;"> <p>The ones digit: Relay output</p> <table border="1" style="width:100%; border-collapse: collapse;"> <thead> <tr> <th>Display</th> <th>Warming-up Compressor</th> <th>Compressor</th> <th>4-way valve</th> <th>Solenoid valve</th> </tr> </thead> <tbody> <tr><td>0</td><td>—</td><td>—</td><td>—</td><td>—</td></tr> <tr><td>1</td><td>—</td><td>—</td><td>—</td><td>ON</td></tr> <tr><td>2</td><td>—</td><td>—</td><td>ON</td><td>—</td></tr> <tr><td>3</td><td>—</td><td>—</td><td>ON</td><td>ON</td></tr> <tr><td>4</td><td>—</td><td>ON</td><td>—</td><td>—</td></tr> <tr><td>5</td><td>—</td><td>ON</td><td>—</td><td>ON</td></tr> <tr><td>6</td><td>—</td><td>ON</td><td>ON</td><td>—</td></tr> <tr><td>7</td><td>—</td><td>ON</td><td>ON</td><td>ON</td></tr> <tr><td>8</td><td>ON</td><td>—</td><td>—</td><td>—</td></tr> <tr><td>A</td><td>ON</td><td>—</td><td>ON</td><td>—</td></tr> </tbody> </table> </div> </div>	Display	Operation Model	O	OFF / FAN	C	COOL / DRY *	H	HEAT	d	DEFROST	Display	Warming-up Compressor	Compressor	4-way valve	Solenoid valve	0	—	—	—	—	1	—	—	—	ON	2	—	—	ON	—	3	—	—	ON	ON	4	—	ON	—	—	5	—	ON	—	ON	6	—	ON	ON	—	7	—	ON	ON	ON	8	ON	—	—	—	A	ON	—	ON	—
Display	Operation Model																																																																	
O	OFF / FAN																																																																	
C	COOL / DRY *																																																																	
H	HEAT																																																																	
d	DEFROST																																																																	
Display	Warming-up Compressor	Compressor	4-way valve	Solenoid valve																																																														
0	—	—	—	—																																																														
1	—	—	—	ON																																																														
2	—	—	ON	—																																																														
3	—	—	ON	ON																																																														
4	—	ON	—	—																																																														
5	—	ON	—	ON																																																														
6	—	ON	ON	—																																																														
7	—	ON	ON	ON																																																														
8	ON	—	—	—																																																														
A	ON	—	ON	—																																																														



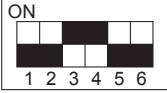

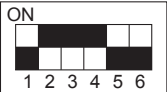
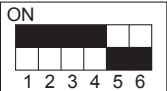
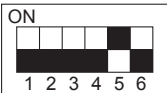
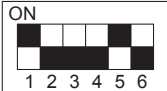

The black square (■) indicates a switch position.

SW2 setting	Display detail	Explanation for display	Unit
	The pipe temperature/Liquid (TH3) -40 to 194 (-40 to 90)	-40 to 194°F (-40 to 90°C) (When the coil thermistor detects 0°F (-17°C) or below, “-” and temperature are displayed alternately.) Example: When -10°F (-23°C) 0.5 s 0.5 s 2 s -□ → 10 → □□ ↑	°F (°C)
	The discharge temperature (TH4) -4 to 422 (-20 to 217)	-4 to 422°F (-20 to 217°C) (When the discharge thermistor detects 100°F (37°C) or more, hundreds digit, tens digit, and ones digit are displayed alternately.) Example: When 221°F (105°C) 0.5 s 0.5 s 2 s □2 → 21 → □□ ↑	°F (°C)
	The output step of outdoor FAN 0 to 16	0 to 16	Step
	The number of ON/OFF times of compressor 0 to 9,999	0 to 9,999 (When the number of times is 100 or more, hundreds digit, tens digit, and ones digit are displayed alternately.) Example: When 42,500 times (425 × 100 times) 0.5 s 0.5 s 2 s □4 → 25 → □□ ↑	100 times
	The compressor integrating operation times 0 to 9,999	0 to 9,999 (When it is 100 hours or more, hundreds digit, tens digit and ones digit are displayed alternately.) Example: When 2,450 hours (245 × 10 hours) 0.5 s 0.5 s 2 s □2 → 45 → □□ ↑	10 hours
	The compressor operating current 0 to 50	0 to 50 Note: Value after the decimal point will be truncated.	A
	The compressor operating frequency 0 to 9,999	0 to 9,999 (When it is 100 Hz or more, hundreds digit, tens digit and ones digit are displayed alternately.) Example: When 125 Hz 0.5 s 0.5 s 2 s 12 → 50 → □□ ↑	0.1 Hz
	The LEV-A opening pulse 0 to 500	0 to 500 (When it is 100 pulse or more, hundreds digit, tens digit and ones digit are displayed alternately.) Example: When 150 pulse 0.5 s 0.5 s 2 s □1 → 50 → □□ ↑	Pulse
	The error postponement code history (1) of outdoor unit	Postponement code display Blinking: During postponement Lighting: Cancellation of postponement “00” is displayed in the case of no postponement.	Code display
	The operation mode when the last error occurred	This setting shows the operation mode when the last error occurred as well as the default setting (Refer to the following). (SW2) 	Code display

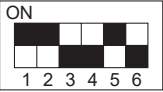
The black square (■) indicates a switch position.

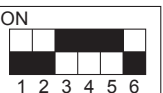
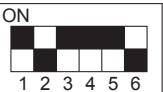

SW2 setting	Display detail	Explanation for display	Unit								
	The pipe temperature/Liquid (TH3) when the last error occurred -38 to 190 (-39 to 88)	-38 to 190°F (-39 to 88°C) (When the temperature is 0°F (-17°C) or below, “-” and temperature are displayed alternately.) Example: When -15°F (-26°C) 0.5 s 0.5 s 2 s -□ → 15 → □□	°F (°C)								
	The discharge temperature (TH4) when the last error occurred -4 to 422 (-20 to 217)	-4 to 422°F (-20 to 217°C) (When the temperature is 0°F (-17°C) or below, “-” and temperature are displayed alternately.) (When the temperature is 100°F (37°C) or more, the hundreds digit, tens digit, and ones digit are displayed alternately.) Example: When 266°F (130°C) 0.5 s 0.5 s 2 s □2 → 66 → □□	°F (°C)								
	The compressor operating current when the last error occurred 0 to 50	0 to 50	A								
	The error history (1) (latest) The alternate display of abnormal unit number and code	When no error history, “ 0 ” and “ - - ” are displayed alternately.	Code display								
	The error history (2) The alternate display of error unit number and code	When no error history, “ 0 ” and “ - - ” are displayed alternately.	Code display								
	The thermo ON time 0 to 999	0 to 999 (When it is 100 minutes or more, the hundreds digit, tens digit and ones digit are displayed alternately.) Example: When 245 minutes 0.5 s 0.5 s 2 s □2 → 45 → □□	Minute								
	The test run elapsed time 0 to 120	0 to 120 (When it is 100 minutes or more, the hundreds digit, tens digit and ones digit are displayed alternately.) Example: When 105 minutes 0.5 s 0.5 s 2 s □1 → 05 → □□	Minute								
	The number of connected indoor units 0 to 4	0 to 4 (The number of connected indoor units is displayed.)	Unit								
	The capacity setting display	Displayed as an outdoor capacity code. <table border="1" data-bbox="863 1736 1182 1853"> <thead> <tr> <th>Capacity</th> <th>Code</th> </tr> </thead> <tbody> <tr> <td>WUZ-SA24NMZ</td> <td>11</td> </tr> <tr> <td>WUZ-SA36NMZ</td> <td>20</td> </tr> <tr> <td>WUZ-SA48NMZ</td> <td>28</td> </tr> </tbody> </table>	Capacity	Code	WUZ-SA24NMZ	11	WUZ-SA36NMZ	20	WUZ-SA48NMZ	28	Code display
Capacity	Code										
WUZ-SA24NMZ	11										
WUZ-SA36NMZ	20										
WUZ-SA48NMZ	28										

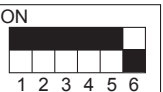
The black square (■) indicates a switch position.

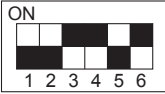

SW2 setting	Display detail	Explanation for display	Unit										
	The outdoor unit setting information	<ul style="list-style-type: none"> The tens digit (Total display for applied setting) <table border="1" data-bbox="790 180 1327 266"> <thead> <tr> <th>Setting details</th> <th>Display details</th> </tr> </thead> <tbody> <tr> <td>H·P / Cooling only</td> <td>0: H·P 1: Cooling only</td> </tr> <tr> <td>Single phase / 3-phase</td> <td>0: Single phase 2: 3-phase</td> </tr> </tbody> </table> The ones digit <table border="1" data-bbox="790 308 1327 372"> <thead> <tr> <th>Setting details</th> <th>Display details</th> </tr> </thead> <tbody> <tr> <td>Defrosting switch</td> <td>0: Normal 1: For high humidity</td> </tr> </tbody> </table> <p>(Example) When heat pump, 3-phase and defrosting (normal) are set up, "20" is displayed.</p>	Setting details	Display details	H·P / Cooling only	0: H·P 1: Cooling only	Single phase / 3-phase	0: Single phase 2: 3-phase	Setting details	Display details	Defrosting switch	0: Normal 1: For high humidity	Code display
Setting details	Display details												
H·P / Cooling only	0: H·P 1: Cooling only												
Single phase / 3-phase	0: Single phase 2: 3-phase												
Setting details	Display details												
Defrosting switch	0: Normal 1: For high humidity												
	The indoor pipe temperature/Liquid (TH2(1)) Indoor 1 -38 to 190 (-39 to 88)	-38 to 190°F (-39 to 88°C) (When the temperature is 0°F (-17°C) or less, "-" and temperature are displayed alternately.)	°F (°C)										
	The indoor pipe temperature Cooling(Eva.): TH2 Heating(Cond.) T63HS -59 to 190 (-51 to 88)	-59 to 190°F (-51 to 88°C) (When the temperature is 0°F (-17°C) or less, "-" and temperature are displayed alternately.)	°F (°C)										
	The return water temperature (THW2) 32 to 140 (0 to 60)	32 to 140°F (0 to 60°C)	°F (°C)										
	The target flow water temperature 32 to 176 (0 to 80)	32 to 176°F (0 to 80°C)	°F (°C)										
	The outdoor pipe temperature Cooling(Cond.): T63HS Heating(Eva.) TH6 -59 to 190 (-51 to 88)	-59 to 190°F (-51 to 88°C) (When the temperature is 0°F (-17°C) or less, "-" and temperature are displayed alternately.)	°F (°C)										
	The ambient temperature (TH7) -59 to 190 (-51 to 88)	-59 to 190°F (-51 to 88°C) (When the temperature is 0°F (-17°C) or less, "-" and temperature are displayed alternately.)	°F (°C)										
	The outdoor heat sink temperature (TH8) -40 to 392 (-40 to 200)	-40 to 392°F (-40 to 200°C) (When the temperature is 0°F (-17°C) or less, "-" and temperature are displayed alternately.) (When the temperature is 100°F (37°C) or more, hundreds digit, tens digit, and ones digit are displayed alternately.)	°F (°C)										
	The discharge superheat (SHd) 32 to 491 (0 to 255) [SHd = TH4 or TH33*-T63HS]	32 to 491°F (0 to 255°C) (When the temperature is 100°F (37°C) or more, hundreds digit, tens digit, and ones digit are displayed alternately.)	°F (°C)										

* Choose higher one

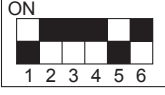
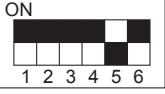
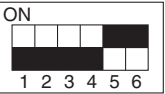
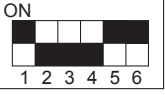
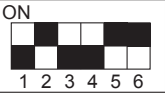
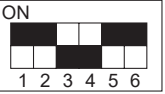
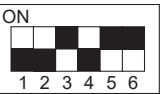
The black square (■) indicates a switch position.



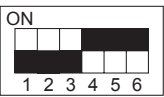
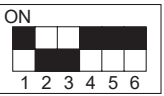

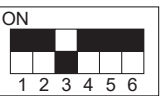
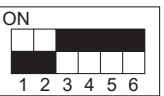
SW2 setting	Display detail	Explanation for display	Unit
	The fan step when the last error occurred 0 to 16	0 to 16	Step
	The LEV-C opening pulse 0 to 500	0 to 500 (When it is 100 pulse or more, hundreds digit, tens digit and ones digit are displayed alternately.) Example: When 130 pulse <div style="text-align: center;"> 0.5 s 0.5 s 2 s □1 → 30 → □□ ↑ </div>	Pulse
	The return water temperature (THW2) when the last error occurred 32 to 140 (0 to 60)	32 to 140°F (0 to 60°C)	°F (°C)
	The indoor pipe temperature/Liquid (TH2) when the last error occurred -38 to 190 (-39 to 88)	-38 to 190°F (-39 to 88°C) (When the temperature is 0°F (-17°C) or less, “-” and temperature are displayed alternately.) Example: When -15°F (-26°C) 0.5 s 0.5 s 2 s <div style="text-align: center;"> -□ → 15 → □□ ↑ </div>	°F (°C)
	The indoor pipe temperature Cooling(Eva.): TH2 Heating(Cond.) T63HS -59 to 190 (-51 to 88)	-59 to 190°F (-51 to 88°C) (When the temperature is 0°F (-17°C) or less, “-” and temperature are displayed alternately.) Example: When -15°F (-26°C) 0.5 s 0.5 s 2 s <div style="text-align: center;"> -□ → 15 → □□ ↑ </div>	°F (°C)
	The outdoor pipe temperature when the last error occurred Cooling(Cond.): T63HS Heating(Eva.) TH6 -59 to 190 (-51 to 88)	-59 to 190°F (-51 to 88°C) (When the temperature is 0°F (-17°C) or less, “-” and temperature are displayed alternately.) Example: When -15°F (-26°C) 0.5 s 0.5 s 2 s <div style="text-align: center;"> -□ → 15 → □□ ↑ </div>	°F (°C)
	The ambient temperature (TH7) when the last error occurred -38 to 190 (-39 to 88)	-38 to 190°F (-39 to 88°C) (When the temperature is 0°F (-17°C) or less, “-” and temperature are displayed alternately.) Example: When -15°F (-26°C) 0.5 s 0.5 s 2 s <div style="text-align: center;"> -□ → 15 → □□ ↑ </div>	°F (°C)
	The outdoor heat sink temperature (TH8) when the last error occurred -40 to 392 (-40 to 200)	-40 to 392°F (-40 to 200°C) (When the temperature is 0°F (-17°C) or less, “-” and temperature are displayed alternately.) (When the temperature is 100°F (37°C) or more, hundreds digit, tens digit, and ones digit are displayed alternately.)	°F (°C)
	The discharge superheat when the last error occurred 32 to 491 (0 to 255) [SHd = TH4 or TH33*-T63HS] * Choose higher one	32 to 491°F (0 to 255°C) (When the temperature is 100°F (37°C) or more, hundreds digit, tens digit, and ones digit are displayed alternately.) Example: When 302°F (150°C) 0.5 s 0.5 s 2 s <div style="text-align: center;"> □3 → 02 → □□ ↑ </div>	°F (°C)
	The degree of subcooling (SC) when the last error occurred 32 to 491 (0 to 255) [SC = T63HS-TH2]	32 to 491°F (0 to 255°C) (When the temperature is 100°F (37°C) or more, hundreds digit, tens digit, and ones digit are displayed alternately.) Example: When 239°F (115°C) 0.5 s 0.5 s 2 s <div style="text-align: center;"> □2 → 39 → □□ ↑ </div>	°F (°C)

The black square (■) indicates a switch position.



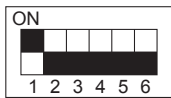
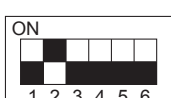
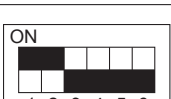

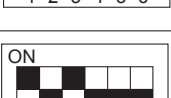
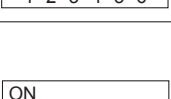
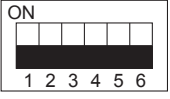
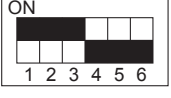
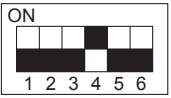
SW2 setting	Display detail	Explanation for display	Unit																
	<p>The thermo-on time until error stops 0 to 999</p>	<p>0 to 999 (When it is 100 minutes or more, hundreds digit, tens digit, and ones digit are displayed alternately.) Example: When 415 minutes</p> <p style="text-align: center;"> 0.5 s 0.5 s 2 s □4 →15 →□□ ↑ </p>	Minute																
	<p>The comp. surface temperature (TH33) -4 to 422 (-20 to 217)</p>	<p>-4 to 422°F (-20 to 217°C) (When the temperature is 0°F (-17°C) or less, "-" and temperature are displayed alternately.) (When the temperature is 100°F (37°C) or more, hundreds digit, tens digit, and ones digit are displayed alternately.) Example: When 221°F (105°C)</p> <p style="text-align: center;"> 0.5 s 0.5 s 2 s □2 →21 →□□ ↑ </p>	°F (°C)																
	<p>The controlling status of compressor operating frequency</p>	<p>The following code will be a help to know the operating status of unit.</p> <ul style="list-style-type: none"> The tens digit <table border="1" style="width: 100%;"> <thead> <tr> <th>Display</th> <th>Compressor operating frequency control</th> </tr> </thead> <tbody> <tr> <td>1</td> <td>Primary current control</td> </tr> <tr> <td>8</td> <td>Secondary current control</td> </tr> </tbody> </table> <ul style="list-style-type: none"> The ones digit (In this digit, the total number of activated control is displayed.) <table border="1" style="width: 100%;"> <thead> <tr> <th>Display</th> <th>Compressor operating frequency control</th> </tr> </thead> <tbody> <tr> <td>1</td> <td>Preventive control for excessive temperature rise of discharge temperature</td> </tr> <tr> <td>2</td> <td>Preventive control for excessive temperature rise of condensing temperature</td> </tr> <tr> <td>4</td> <td>Frost prevention control</td> </tr> <tr> <td>8</td> <td>Preventive control for excessive temperature rise of radiator panel</td> </tr> </tbody> </table> <p>Example: The following controls are activated.</p> <ul style="list-style-type: none"> Primary current control Preventive control for excessive temperature rise of condensing temperature Preventive control for excessive temperature rise of heat sink <div style="text-align: right;"> <p>LED</p>  </div>	Display	Compressor operating frequency control	1	Primary current control	8	Secondary current control	Display	Compressor operating frequency control	1	Preventive control for excessive temperature rise of discharge temperature	2	Preventive control for excessive temperature rise of condensing temperature	4	Frost prevention control	8	Preventive control for excessive temperature rise of radiator panel	Code display
Display	Compressor operating frequency control																		
1	Primary current control																		
8	Secondary current control																		
Display	Compressor operating frequency control																		
1	Preventive control for excessive temperature rise of discharge temperature																		
2	Preventive control for excessive temperature rise of condensing temperature																		
4	Frost prevention control																		
8	Preventive control for excessive temperature rise of radiator panel																		
	<p>The software check sum 0,000 to FFFF</p>	0,000 to FFFF	-																
	<p>The outdoor suction pipe temperature (TH32) -38 to 190 (-39 to 88)</p>	<p>-38 to 190°F (-39 to 88°C) (When the temperature is 0°F (-17°C) or less, "-" and temperature are displayed alternately.) Example: When 5°F (-15°C)</p> <p style="text-align: center;"> 0.5 s 0.5 s 2 s □□ →□5 →□□ ↑ </p>	°F (°C)																

<Service check mode:SW7-2 ON Backup data>



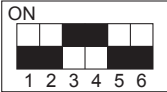

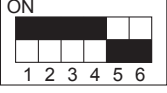
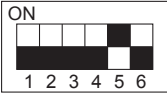
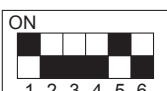

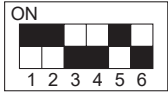
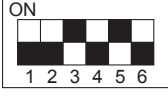
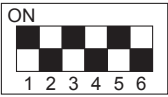
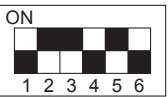

The black square (■) indicates a switch position.

SW2 setting	Display detail	Explanation for display	Unit
	The primary current when the last error occurred 0 to 50	0 to 50	A
	The DC bus voltage when the last error occurred 100 to 1,023	100 to 1,023 (When it is 100 or more, hundreds digit, tens digit, and ones digit are displayed alternately.)	V
	The suction pipe temperature (TH32) when the last error occurred -38 to 190 (-39 to 88)	-38 to 190°F (-39 to 88°C) (When it is 0°F (-17°C) or less, “-” and numbers are displayed alternately.)	°F (°C)
	The comp. surface temperature (TH33) when the last error occurred -4 to 422 (-20 to 217)	-4 to 422°F (-20 to 217°C) (When it is 0°F (-17°C) or less, “-” and numbers are displayed alternately.) (When it is 100°F (37°C) or more, hundreds digit, tens digit, and ones digit are displayed alternately.)	°F (°C)
	The LEV-B opening pulse when the last error occurred 0 to 500	0 to 500 (When it is 100 or more, hundreds digit, tens digit, and ones digit are displayed alternately.)	Pulse
	The LEV-C opening pulse when the last error occurred 0 to 500	0 to 500 (When it is 100 or more, hundreds digit, tens digit, and ones digit are displayed alternately.)	Pulse
	The operation mode when the second-to-last error occurred	This setting shows the operation mode when the second-to-last error occurred as well as the default setting (Refer to the following). (SW2) 	Mode
	The operating frequency when the second-to-last error occurred 0 to 255	0 to 255 (When it is 100 or more, hundreds digit, tens digit, and ones digit are displayed alternately.)	Hz
	The compressor current when the second-to-last error occurred 0 to 50	0 to 50	A
	The primary current when the second-to-last error occurred 0 to 500	0 to 500 (When it is 100 or more, hundreds digit, tens digit, and ones digit are displayed alternately.)	0.1 A
	The DC bus voltage when the second-to-last error occurred 100 to 1,023	100 to 1,023 (When it is 100 or more, hundreds digit, tens digit, and ones digit are displayed alternately.)	V

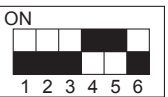
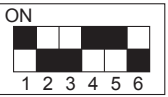
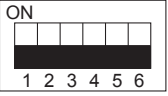

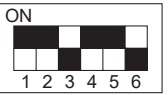
The black square (■) indicates a switch position.

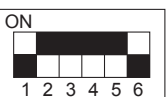
SW2 setting	Display detail	Explanation for display	Unit
	The fan step when the second-to-last error occurred 0 to 16	0 to 16	Step
	The return water temperature (THW2) when the second-to-last error occurred 32 to 140 (0 to 60)	32 to 140°F (0 to 60°C)	°F (°C)
	The indoor liquid pipe temperature (TH2) when the second-to-last error occurred (The average temperature when 2 or more indoor units are connected) -38 to 190 (-39 to 88)	-38 to 190°F (-39 to 88°C) Indoor liquid pipe temperature (TH2) $\Sigma(\text{TH2}(\text{N}))/n$ (When it is 0°F (-17°C) or less, “-” and numbers are displayed alternately.)	°F (°C)
	The indoor pipe temperature Cooling(Eva.): TH2 Heating(Cond.) T63HS -59 to 190 (-51 to 88)	-59 to 190°F (-51 to 88°C) Indoor pipe temperature/Cond./Eva. (T63HS) $\Sigma(\text{T63HS}(\text{N}))/n$ (When it is 0°F (-17°C) or less, “-” and numbers are displayed alternately.)	°F (°C)
	The discharge temperature (TH4) when the second-to-last error occurred -4 to 422 (-20 to 217)	-4 to 422°F (-20 to 217°C) (When it is 0°F (-17°C) or less, “-” and numbers are displayed alternately.) (When it is 100°F (37°C) or more, hundreds digit, tens digit, and ones digit are displayed alternately.)	°F (°C)
	The outdoor liquid pipe temperature (TH3) when the second-to-last error occurred -38 to 190 (-39 to 88)	-38 to 190°F (-39 to 88°C) (When it is 0°F (-17°C) or less, “-” and numbers are displayed alternately.)	°F (°C)
	The outdoor pipe temperature when the second-to-last error occurred Cooling(Cond.): T63HS Heating(Eva.) TH6 -59 to 190 (-51 to 88)	-59 to 190°F (-51 to 88°C) (When it is 0°F (-17°C) or less, “-” and numbers are displayed alternately.)	°F (°C)
	The ambient temperature (TH7) when the second-to-last error occurred -38 to 190 (-39 to 88)	-38 to 190°F (-39 to 88°C) (When it is 0°F (-17°C) or less, “-” and numbers are displayed alternately.)	°F (°C)

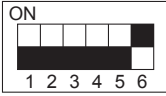
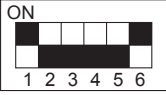
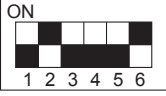
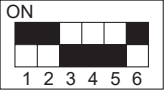
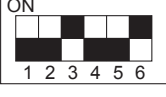
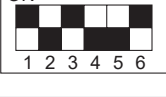

The black square (■) indicates a switch position.

SW2 setting	Display detail	Explanation for display	Unit
	The heat sink temperature (TH8) when the second-to-last error occurred -40 to 392 (-40 to 200)	-40 to 392°F (-40 to 200°C) (When it is 0°F (-17°C) or less, “-” and numbers are displayed alternately.) (When it is 100°F (37°C) or more, hundreds digit, tens digit, and ones digit are displayed alternately.)	°F (°C)
	The suction pipe temperature (TH32) when the second-to-last error occurred -38 to 190 (-39 to 88)	-38 to 190°F (-39 to 88°C) (When it is 0°F (-17°C) or less, “-” and numbers are displayed alternately.)	°F (°C)
	The Comp. surface temperature (TH33) when the second-to-last error occurred -4 to 423 (-20 to 217)	-4 to 423°F (-20 to 217°C) (When it is 0°F (-17°C) or less, “-” and numbers are displayed alternately.) (When it is 100°F (37°C) or more, hundreds digit, tens digit, and ones digit are displayed alternately.)	°F (°C)
	The LEV-A opening pulse when the second-to-last error occurred 0 to 500	0 to 500 (When it is 100 or more, hundreds digit, tens digit, and ones digit are displayed alternately.)	Pulse
	The LEV-B opening pulse when the second-to-last error occurred 0 to 500	0 to 500 (When it is 100 or more, hundreds digit, tens digit, and ones digit are displayed alternately.)	Pulse
	The LEV-C opening pulse when the second-to-last error occurred 0 to 500	0 to 500 (When it is 100 or more, hundreds digit, tens digit, and ones digit are displayed alternately.)	Pulse
	The operation mode when the third-to-last error occurred	This setting shows the operation mode when the third-to-last error occurred as well as the default setting (Refer to the following). (SW2) 	Mode
	The operating frequency when the third-to-last error occurred 0 to 255	0 to 255 (When it is 100 or more, hundreds digit, tens digit, and ones digit are displayed alternately.)	Hz
	The compressor current when the third-to-last error occurred 0 to 50	0 to 50	A
	The primary current when the third-to-last error occurred 0 to 500	0 to 500 (When it is 100 or more, hundreds digit, tens digit, and ones digit are displayed alternately.)	0.1 A
	The DC bus voltage when the third-to-last error occurred 100 to 1,023	100 to 1,023 (When it is 100 or more, hundreds digit, tens digit, and ones digit are displayed alternately.)	V
	The fan step when the third-to-last error occurred 0 to 16	0 to 16	Step
	The return water temperature (THW2) when the third-to-last error occurred 32 to 140 (0 to 60)	32 to 140°F (0 to 60°C)	°F (°C)

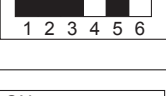
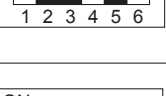
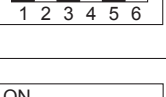
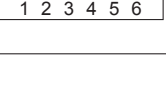
The black square (■) indicates a switch position.

SW2 setting	Display detail	Explanation for display	Unit
	The indoor liquid pipe temperature (TH2) when the third-to-last error occurred -38 to 190 (-39 to 88)	-38 to 190°F (-39 to 88°C) Indoor liquid pipe temperature (TH2) $\Sigma(\text{TH2(N)})/n$ (When it is 0°F (-17°C) or less, “-” and numbers are displayed alternately.)	°F (°C)
	The indoor pipe temperature Cooling(Eva.): TH2 Heating(Cond.) T63HS -59 to 190 (-51 to 88)	-59 to 190°F (-51 to 88°C) Indoor pipe temperature/Cond./Eva. (T63HS) $\Sigma(\text{T63HS(N)})/n$ (When it is 0°F (-17°C) or less, “-” and numbers are displayed alternately.)	°F (°C)
	The discharge temperature (TH4) when the third-to-last error occurred -4 to 422 (-20 to 217)	-4 to 422°F (-20 to 217°C) (When it is 0°F (-17°C) or less, “-” and numbers are displayed alternately.) (When it is 100°F (37°C) or more, hundreds digit, tens digit, and ones digit are displayed alternately.)	°F (°C)
	The outdoor liquid pipe temperature (TH3) when the third-to-last error occurred -38 to 190 (-39 to 88)	-38 to 190°F (-39 to 88°C) (When it is 0°F (-17°C) or less, “-” and numbers are displayed alternately.)	°F (°C)
	The outdoor pipe temperature when the third-to-last error occurred Cooling(Cond.): T63HS Heating(Eva.) TH6 -59 to 190 (-51 to 88)	-59 to 190°F (-51 to 88°C) (When it is 0°F (-17°C) or less, “-” and numbers are displayed alternately.)	°F (°C)
	The ambient temperature (TH7) when the third-to-last error occurred -38 to 190 (-39 to 88)	-38 to 190°F (-39 to 88°C) (When it is 0°F (-17°C) or less, “-” and numbers are displayed alternately.)	°F (°C)
	The heat sink temperature (TH8) when the third-to-last error occurred -40 to 392 (-40 to 200)	-40 to 392°F (-40 to 200°C) (When it is 0°F (-17°C) or less, “-” and numbers are displayed alternately.) (When it is 100°F (37°C) or more, hundreds digit, tens digit, and ones digit are displayed alternately.)	°F (°C)
	The suction pipe temperature (TH32) when the third-to-last error occurred -38 to 190 (-39 to 88)	-38 to 190°F (-39 to 88°C) (When it is 0°F (-17°C) or less, “-” and numbers are displayed alternately.)	°F (°C)
	The Comp. surface temperature (TH33) when the third-to-last error occurred -4 to 422 (-20 to 217)	-4 to 422°F (-20 to 217°C) (When it is 0°F (-17°C) or less, “-” and numbers are displayed alternately.) (When it is 100°F (37°C) or more, hundreds digit, tens digit, and ones digit are displayed alternately.)	°F (°C)
	The LEV-A opening pulse when the third-to-last error occurred 0 to 500	0 to 500 (When it is 100 or more, hundreds digit, tens digit, and ones digit are displayed alternately.)	Pulse
	The LEV-B opening pulse when the third-to-last error occurred 0 to 500	0 to 500 (When it is 100 or more, hundreds digit, tens digit, and ones digit are displayed alternately.)	Pulse
	The LEV-C opening pulse when the third-to-last error occurred 0 to 500	0 to 500 (When it is 100 or more, hundreds digit, tens digit, and ones digit are displayed alternately.)	Pulse

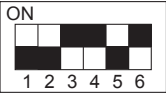
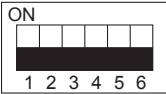
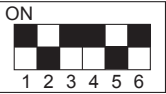
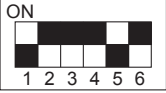
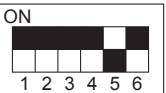
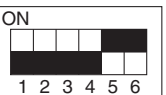
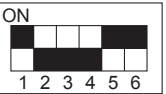
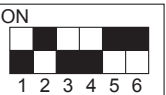
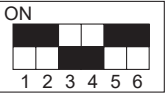
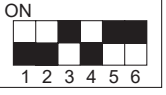
The black square (■) indicates a switch position.

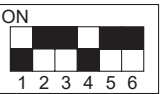
SW2 setting	Display detail	Explanation for display	Unit
	The operation mode when the fourth-to-last error occurred	This setting shows the operation mode when the fourth-to-last error occurred as well as the default setting (Please refer to the following). (SW2) 	Mode
	The operating frequency when the fourth-to-last error occurred 0 to 255	0 to 255 (When it is 100 or more, hundreds digit, tens digit, and ones digit are displayed alternately.)	Hz
	The compressor current when the fourth-to-last error occurred 0 to 50	0 to 50	A
	The primary current when the fourth-to-last error occurred 0 to 500	0 to 500 (When it is 100 or more, hundreds digit, tens digit, and ones digit are displayed alternately.)	0.1 A
	The DC bus voltage when the fourth-to-last error occurred 100 to 1,023	100 to 1,023 (When it is 100 or more, hundreds digit, tens digit, and ones digit are displayed alternately.)	V
	The fan step when the fourth-to-last error occurred 0 to 16	0 to 16	Step
	The return water temperature (THW2) when the fourth-to-last error occurred 32 to 140 (0 to 60)	32 to 140°F (0 to 60°C)	°F (°C)
	The indoor liquid pipe temperature (TH2) when the fourth-to-last error occurred -38 to 190 (-39 to 88)	-38 to 190°F (-39 to 88°C) Indoor liquid pipe temperature (TH2) $\Sigma(\text{TH2(N)})/n$ (When it is 0°F (-17°C) or less, “-” and numbers are displayed alternately.)	°F (°C)
	The indoor pipe temperature Cooling(Eva.): TH2 Heating(Cond.) T63HS -38 to 190 (-39 to 88)	-38 to 190°F (-39 to 88°C) Indoor pipe temperature/Cond./Eva. (T63HS) $\Sigma(\text{T63HS(N)})/n$ (When it is 0°F (-17°C) or less, “-” and numbers are displayed alternately.)	°F (°C)
	The discharge temperature (TH4) when the fourth-to-last error occurred -4 to 422 (-20 to 217)	-4 to 422°F (-20 to 217°C) (When it is 0°F (-17°C) or less, “-” and numbers are displayed alternately.) (When it is 100°F (37°C) or more, hundreds digit, tens digit, and ones digit are displayed alternately.)	°F (°C)
	The outdoor liquid pipe temperature (TH3) when the fourth-to-last error occurred	-38 to 190°F (-39 to 88°C) (When it is 0°F (-17°C) or less, “-” and numbers are displayed alternately.)	°F (°C)

The black square (■) indicates a switch position.

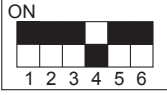
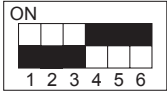
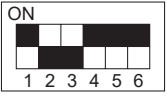
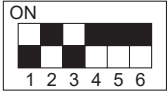
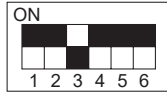
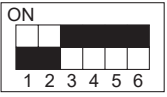
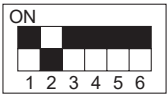
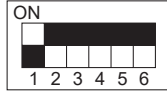
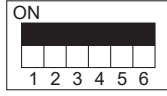
SW2 setting	Display detail	Explanation for display	Unit
	<p>The outdoor pipe temperature when the fourth-to-last error occurred</p> <p>Cooling(Cond.): T63HS Heating(Eva.) TH6</p> <p>-59 to 190 (-51 to 88)</p>	<p>-59 to 190°F (-51 to 88°C)</p> <p>(When it is 0°F (-17°C) or less, “-” and numbers are displayed alternately.)</p>	°F (°C)
	<p>The ambient temperature (TH7) when the fourth-to-last error occurred</p> <p>-38 to 190 (-39 to 88)</p>	<p>-38 to 190°F (-39 to 88°C)</p> <p>(When it is 0°F (-17°C) or less, “-” and numbers are displayed alternately.)</p>	°F (°C)
	<p>The heat sink temperature (TH8) when the fourth-to-last error occurred</p> <p>-40 to 392 (-40 to 200)</p>	<p>-40 to 392°F (-40 to 200°C)</p> <p>(When it is 0°F (-17°C) or less, “-” and numbers are displayed alternately.)</p> <p>(When it is 100°F (37°C) or more, hundreds digit, tens digit, and ones digit are displayed alternately.)</p>	°F (°C)
	<p>The suction pipe temperature (TH32) when the fourth-to-last error occurred</p> <p>-38 to 190 (-39 to 88)</p>	<p>-38 to 190°F (-39 to 88°C)</p> <p>(When it is 0°F (-17°C) or less, “-” and numbers are displayed alternately.)</p>	°F (°C)
	<p>The Comp. surface temperature (TH33) when the fourth-to-last error occurred</p> <p>-4 to 422 (-20 to 217)</p>	<p>-4 to 422°F (-20 to 217°C)</p> <p>(When it is 0°F (-17°C) or less, “-” and numbers are displayed alternately.)</p> <p>(When it is 100°F (37°C) or more, hundreds digit, tens digit, and ones digit are displayed alternately.)</p>	°F (°C)
	<p>The LEV-A opening pulse when the fourth-to-last error occurred</p> <p>0 to 500</p>	<p>0 to 500</p> <p>(When it is 100 or more, hundreds digit, tens digit, and ones digit are displayed alternately.)</p>	Pulse
	<p>The LEV-B opening pulse when the fourth-to-last error occurred</p> <p>0 to 500</p>	<p>0 to 500</p> <p>(When it is 100 or more, hundreds digit, tens digit, and ones digit are displayed alternately.)</p>	Pulse
	<p>The LEV-C opening pulse when the fourth-to-last error occurred</p> <p>0 to 500</p>	<p>0 to 500</p> <p>(When it is 100 or more, hundreds digit, tens digit, and ones digit are displayed alternately.)</p>	Pulse
	<p>The LEV-A opening pulse when the last error occurred</p> <p>0 to 500</p>	<p>0 to 500</p> <p>(When it is 100 or more, hundreds digit, tens digit, and ones digit are displayed alternately.)</p>	Pulse

10-1. Request code list

Certain indoor/outdoor combinations do not have the request code function; therefore, no request codes are displayed. Refer to indoor unit service manual for how to use the controllers and request codes for indoor unit.

Request code	Request content	Description (Display range)	Unit	Remarks
0	Operation state	Refer to 10-1-1. Detail Contents in Request Code.	—	
1	Compressor-Operating current (rms)	0 to 50	A	
2	Compressor-Accumulated operating time	0 to 9,999	10 hours	
3	Compressor-Number of operation times	0 to 9,999	100 times	
4	Discharge temperature (TH4)	-4 to 422 (-20 to 217)	°F (°C)	
5	Outdoor unit -Liquid pipe 1 temperature (TH3)	-40 to 194 (-40 to 90)	°F (°C)	
6				
7	Outdoor unit-2-phase pipe temperature Cooling: (T63HS), Heating: (TH6)	-59 to 190 (-51 to 88)	°F (°C)	
8	Outdoor unit-Suction pipe temperature (TH32)	-38 to 190 (-39 to 88)	°F (°C)	
9	Outdoor unit-Ambient temperature (TH7)	-38 to 190 (-39 to 88)	°F (°C)	
10	Outdoor unit-Heat sink temperature (TH8)	-40 to 392 (-40 to 200)	°F (°C)	
11	Outdoor unit-Comp.Surface temperature (TH33)	-4 to 422 (-20 to 217)	°F (°C)	
12	Discharge superheat (SHd)	32 to 491 (0 to 255)	°F (°C)	
13	Degree of subcooling (SC)	32 to 491 (0 to 255)	°F (°C)	
14				
15				
16	Compressor-Operating frequency	0 to 255	Hz	
17	Compressor-Target operating frequency	0 to 255	Hz	
18	Outdoor unit-Fan output step	0 to 16	Step	
19	Outdoor unit-Fan 1 speed (Only for air conditioners with DC fan motor)	0 to 9,999	rpm	
20	Outdoor unit-Fan 2 speed (Only for air conditioners with DC fan motor)	0 to 9,999	rpm	"0" is displayed if the air conditioner is a single-fan type.
21				
22	LEV (A) opening	0 to 500	Pulses	
23	LEV (B) opening	0 to 500	Pulses	
24	LEV (C) opening	0 to 500	Pulses	
25	Primary current	0 to 50	A	
26	DC bus voltage	100 to 1,023	V	
27				
28				
29				
30				
31				
32				
33				
34				
35				
36				
37				
38				
39				
40				
41	Indoor unit-Liquid pipe temperature (TH2)	-38 to 190 (-39 to 88)	°F (°C)	
42				
43				
44				
45				
46	Indoor unit-2-phase pipe temperature Cooling: (TH2), Heating (TH63HS)	-59 to 190 (-51 to 88)	°F (°C)	
47				
48	Thermostat ON operating time	0 to 999	Minutes	
49				

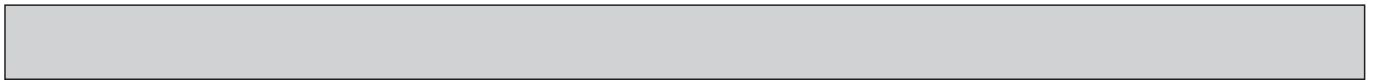

Request code	Request content	Description (Display range)	Unit	Remarks
50				
51	Outdoor unit-Control state	Refer to 10-1-1.Detail Contents in Request Code.	—	
52	Compressor-Frequency control state	Refer to 10-1-1.Detail Contents in Request Code.	—	
53	Outdoor unit-Fan control state	Refer to 10-1-1.Detail Contents in Request Code.	—	
54	Actuator output state	Refer to 10-1-1.Detail Contents in Request Code.	—	
55	Error content (U9)	Refer to 10-1-1.Detail Contents in Request Code.	—	
56				
57				
58				
59				
60				
61				
62				
63				
64				
65				
66				
67				
68				
69				
70	Outdoor unit-Capacity setting display	Refer to 10-1-1.Detail Contents in Request Code.	—	
71	Outdoor unit-Setting information	Refer to 10-1-1.Detail Contents in Request Code.	—	
72				
73				
74				
75				
76				
77				
78				
79				
80				
81				
82				
83				
84				
85				
86				
87				
88				
89				
90	Outdoor unit-Microprocessor version information	Examples) Ver. 5.01 → "0,501"	Ver.	
91	Outdoor unit-Microprocessor version information (sub No.)	Auxiliary information (displayed after version information) Examples) Ver. 5.01 A000 → "A000"	—	
92				
93				
94				
95				
96				
97				
98				
99				
100	Outdoor unit - Error postponement history 1 (latest)	Displays postponement code. (" - - " is displayed if no postponement code is present)	Code	
101	Outdoor unit - Error postponement history 2 (previous)	Displays postponement code. (" - - " is displayed if no postponement code is present)	Code	
102	Outdoor unit - Error postponement history 3 (last but one)	Displays postponement code. (" - - " is displayed if no postponement code is present)	Code	

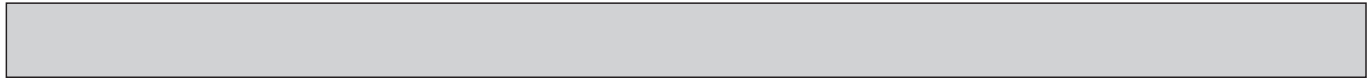

Request code	Request content	Description (Display range)	Unit	Remarks
103	Error history 1 (latest)	Displays error history. (" --" is displayed if no history is present.)	Code	
104	Error history 2 (second to last)	Displays error history. (" --" is displayed if no history is present.)	Code	
105	Error history 3 (third to last)	Displays error history. (" --" is displayed if no history is present.)	Code	
106	Abnormal thermistor display (TH3/TH4/TH6/TH7/TH8/TH32/TH33)	3: TH3/TH32 4: TH4 6: TH6 7: TH7 8: TH8 33: TH33 0: No thermistor error	Sensor number	
107	Operation mode when the last error occurred	Displayed in the same way as request code "0".	—	
108	Compressor-Operating current when the last error occurred	0 to 50	A	
109	Compressor-Accumulated operating time when the last error occurred	0 to 9,999	10 hours	
110	Compressor-Number of operation times when the last error occurred	0 to 9,999	100 times	
111	Discharge temperature when the last error occurred	-4 to 422 (-20 to 217)	°F (°C)	
112	Outdoor unit -Liquid pipe 1 temperature (TH3) when the last error occurred	-40 to 194 (-40 to 90)	°F (°C)	
113				
114	Outdoor unit-2-phase pipe temperature Cooling: (T63HS), Heating: (TH6) when the last error occurred	-59 to 190 (-51 to 88)	°F (°C)	
115	Outdoor unit-Suction pipe temperature (TH32) when the last error occurred	-38 to 190 (-39 to 88)	°F (°C)	
116	Outdoor unit-Ambient temperature (TH7) when the last error occurred	-38 to 190 (-39 to 88)	°F (°C)	
117	Outdoor unit-Heat sink temperature (TH8) when the last error occurred	-40 to 392 (-40 to 200)	°F (°C)	
118	Discharge superheat (SHd) when the last error occurred	32 to 491 (0 to 255)	°F (°C)	
119	Degree of subcooling (SC) when the last error occurred	32 to 491 (0 to 255)	°F (°C)	
120	Compressor-Operating frequency when the last error occurred	0 to 255	Hz	
121	Outdoor unit when the last error occurred • Fan output step	0 to 16	Step	
122	Outdoor unit when the last error occurred • Fan 1 speed (Only for air conditioners with DC fan)	0 to 9,999	rpm	
123	Outdoor unit when the last error occurred • Fan 2 speed (Only for air conditioners with DC fan)	0 to 9,999	rpm	"0" is displayed if the air conditioner is a single-fan type.
124				
125	LEV (A) opening pulse when the last error occurred	0 to 500	Pulses	
126	LEV (B) opening pulse when the last error occurred	0 to 500	Pulses	
127	LEV (C) opening pulse when the last error occurred	0 to 500	Pulses	
128				
129				
130	Thermostat ON time until operation stops due to error	0 to 999	Minutes	
131				
132	Indoor unit-Liquid pipe temperature (TH2) when the last error occurred	-38 to 190 (-39 to 88)	°F (°C)	
133	Indoor unit-2-phase pipe temperature Cooling: (TH2), Heating: (TH63HS) when the last error occurred	-59 to 190 (-51 to 88)	°F (°C)	
134				
135	Error content (U9) at last time	Refer to 10-1-1.Detail Contents in Request Code.	—	

10-1-1. Detail Contents in Request Code

[Operation state] (Request code: "0")

Data display

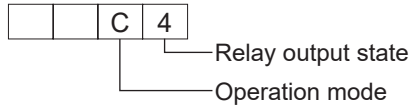

Operation mode

Display	Operation mode
0	STOP • FAN
C	COOL • DRY
H	HEAT
d	DEFROST

Relay output state

Display	Power currently supplied to compressor	Compressor	Four-way valve	Solenoid valve
0	—	—	—	—
1				ON
2			ON	
3			ON	ON
4		ON		
5		ON		ON
6		ON	ON	
7		ON	ON	ON
8	ON			
A	ON		ON	

[Outdoor unit – Control state] (Request code: "51")

Data display	State
0 0 0 0	Normal
0 0 0 1	Preparing for heat operation
0 0 0 2	Defrost

[Compressor – Frequency control state] (Request code: "52")

Data display

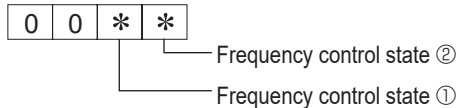

Frequency control state ①

Display	Current limit control
0	No current limit
1	Primary current limit control is ON.
2	Secondary current limit control is ON.

Frequency control state ②

Display	Discharge temperature overheat prevention	Condensation temperature overheat prevention	Anti-freeze protection control	Heat sink temperature overheat prevention
0				
1	Controlled			
2		Controlled		
3	Controlled	Controlled		
4			Controlled	
5	Controlled		Controlled	
6		Controlled	Controlled	
7	Controlled	Controlled	Controlled	
8				Controlled
9	Controlled			Controlled
A		Controlled		Controlled
b	Controlled	Controlled		Controlled
C			Controlled	Controlled
d	Controlled		Controlled	Controlled
E		Controlled	Controlled	Controlled
F	Controlled	Controlled	Controlled	Controlled

[Fan control state] (Request code: "53")

Data display

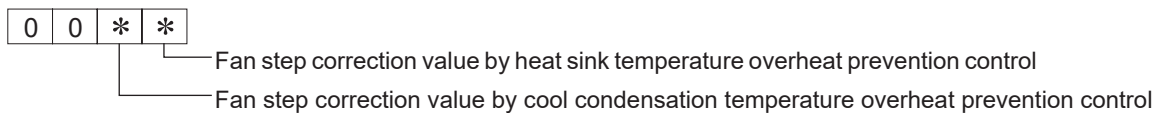

Display	Correction value
– (minus)	–1
0	0
1	+1
2	+2

[Actuator output state] (Request code: "54")

Data display

0	0	*	*
---	---	---	---

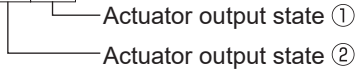

Actuator output state ①

Actuator output state ②

Display	SV1	Four-way valve	Compressor	Compressor is warming up
0				
1	ON			
2		ON		
3	ON	ON		
4			ON	
5			ON	
6		ON	ON	
7	ON	ON	ON	
8				ON
9	ON			ON
A		ON		ON
b	ON	ON		ON
C			ON	ON
d	ON		ON	ON
E		ON	ON	ON
f	ON	ON	ON	ON

Display	52C	SV2	SS
0			
1	ON		
2		ON	
3	ON	ON	
4			ON
5	ON		ON
6		ON	ON
7	ON	ON	ON

[Error content (U9)] (Request code: "55", "135")

Data display

0	0	*	*
---	---	---	---

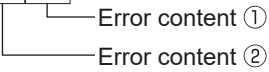

Error content ①

● : Detected

Display	Overvoltage error	Undervoltage error	L1-phase open error	Power synchronizing signal error
0				
1	●			
2		●		
3	●	●		
4			●	
5	●		●	
6		●	●	
7	●	●	●	
8				●
9	●			●
A		●		●
b	●	●		●
C			●	●
d	●		●	●
E		●	●	●
f	●	●	●	●

Error content ②

● : Detected

Display	Converter Fo error	Voltage sensor error
0		
1	●	
2		
3	●	
4		
5		
6		
7		
8		●
9	●	●
A		●
B	●	●

[Outdoor unit - Capacity setting display] (Request code: "70")

Data display	Capacity
11	24
20	36
28	48

[Outdoor unit – Setting information] (Request code: "71")

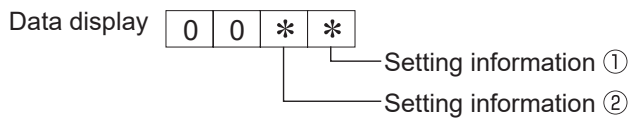

Setting information ①

Display	Defrost mode
0	Standard
1	For high humidity

Setting information ②

Display	Single-/ 3-phase	Heat pump/ cooling only
0	Single-phase	Heat pump
1		Cooling only
2	3-phase	Heat pump
3		Cooling only

11 DISASSEMBLY PROCEDURE

Note. If the red labels have been removed from the refrigerant piping during the operation, e.g. during recovering the refrigerant, please put them back to their original position after the operation.

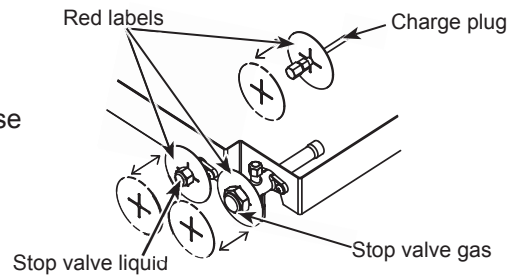

—————> : Indicates the visible parts in the photos/figures.
 - - - - -> : Indicates the invisible parts in the photos/figures.

PROCEDURE	PHOTOS/ FIGURES
<p>1. Removing the service panel and top panel</p> <p>(1) Remove the service panel fixing screws (3 for front and 1 for right/ 5 × 12), then slide the service panel downward to remove it. (The service panel is fixed to the side panel (R) with a hook on the right side.)</p> <p>(2) Remove the top panel fixing screws (3 for front, 3 for rear and 1 for right/ 5 × 12) to remove the top panel.</p> <p>Note 1: When removing service panel and top panel at the same time, count 2 less screws since they share the screws.</p>	<p>Photo 1</p>

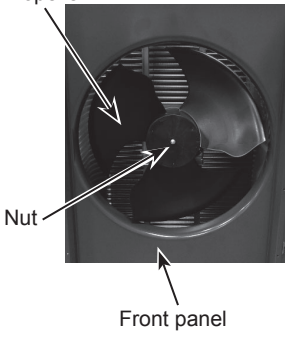
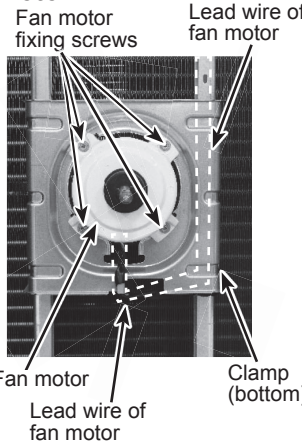
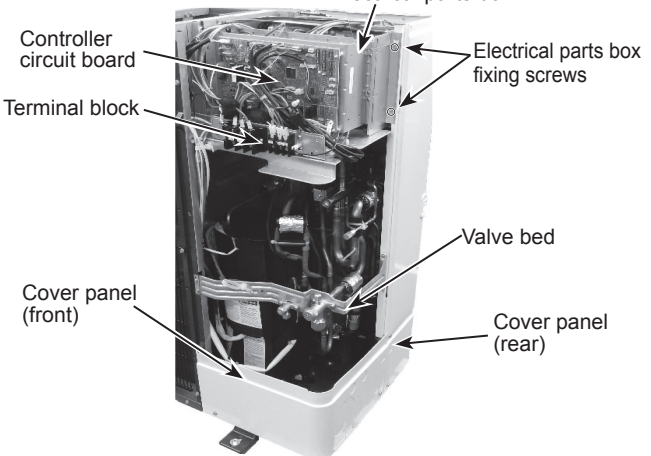
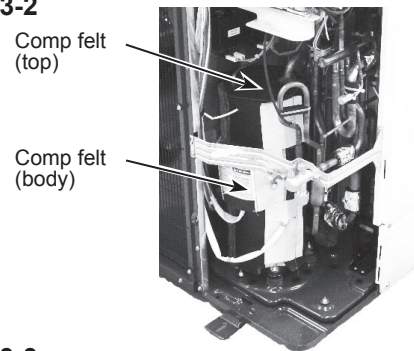
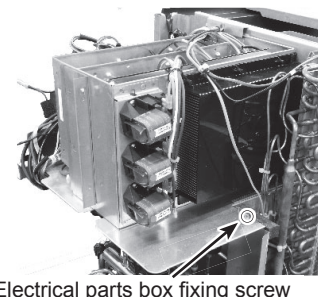
PROCEDURE	PHOTOS/ FIGURES	
<p>2. Removing the fan motor (MF1)</p> <ol style="list-style-type: none"> (1) Remove the service panel. (See Photo 1) (2) Remove the top panel. (See Photo 1) (3) Remove the wire grille fixing screws (6 for front/ 5 × 12), then slide the wire grille upward to remove it. (See Photo 1) (4) Remove the screw of nut (1 for front/ M6), then slide the propeller fan forward to remove it. (5) Disconnect the connector CNF1 (WH) on the controller circuit board in the electrical parts box. (6) Loosen the clamps for the lead wire on motor support and separator. (7) Remove the fan motor fixing screws (4 for front/ 5 × 20) to remove the fan motor. <p>Note 1: When attaching the fan motor, be sure to route the cable through the hook below the fan motor and fix it firmly with the bottom clamp (See Photo 2-2). Make sure that the cable is routed as before, shown in the photo.</p> <p>Note 2: Tighten the propeller fan nut with a torque of 5.7 ± 0.3 N·m.</p>	<p>Photo 2-1</p>  <p>Propeller</p> <p>Nut</p> <p>Front panel</p>	<p>Photo 2-2</p>  <p>Fan motor fixing screws</p> <p>Lead wire of fan motor</p> <p>Fan motor</p> <p>Lead wire of fan motor</p> <p>Clamp (bottom)</p>
<p>3. Removing the electrical parts box</p> <ol style="list-style-type: none"> (1) Remove the service panel. (See Photo 1) (2) Remove the top panel. (See Photo 1) (3) Disconnect the power supply cable from terminal block. (4) Disconnect the indoor/outdoor connecting wire from terminal block. (5) Disconnect the connectors CNF1 (WH), TH3 (WH), TH4 (WH), TH7/6 (RD), TH32 (BK), TH33 (YE), 63H (YE), 63HS (WH), 21S4 (GN), LEV-A (WH), LEV-B (RD) and LEV-C (BU)(*1) from the controller circuit board. <p><Symbols on the board></p> <ul style="list-style-type: none"> • Fan motor (CNF1) • Thermistor <Liquid> (TH3) • Thermistor <Discharge> (TH4) • Thermistor <Ambient/2-Phase Pipe> (TH7/6) • Thermistor <Suction> (TH32) • Thermistor <Comp. Surface> (TH33) • High pressure switch (63H) • High pressure sensor (63HS) • 4-way valve (21S4) • LEV (LEV-A, LEV-B, LEV-C) <ol style="list-style-type: none"> (6) Remove the cover panel (front) fixing screws (1 for front and 1 for right/ 5 × 12) to remove the cover panel (front). (7) Loosen the clamps, fasteners, band and cable straps for the lead wire in the electrical parts box and separator. (8) Open the comp felt and remove the terminal cover of the compressor. Disconnect the U (RD), V (WH), W (BK) compressor lead wires. (9) Remove the electrical parts box fixing screws (2 for front and 1 for top/ 5 × 12), then slide the electrical parts box upward to remove it. (The electrical parts box is fixed to the side panel (R) with a hook on the right side, and to the separator duct with a hook on the left side.) 	<p>Photo 3-1</p>  <p>Electrical parts box</p> <p>Controller circuit board</p> <p>Terminal block</p> <p>Valve bed</p> <p>Cover panel (front)</p> <p>Cover panel (rear)</p> <p>Electrical parts box fixing screws</p>	<p>Photo 3-2</p>  <p>Comp felt (top)</p> <p>Comp felt (body)</p> <p>Photo 3-3</p>  <p>Electrical parts box fixing screw</p>

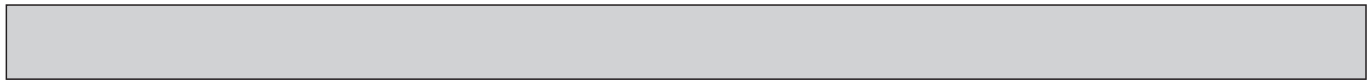

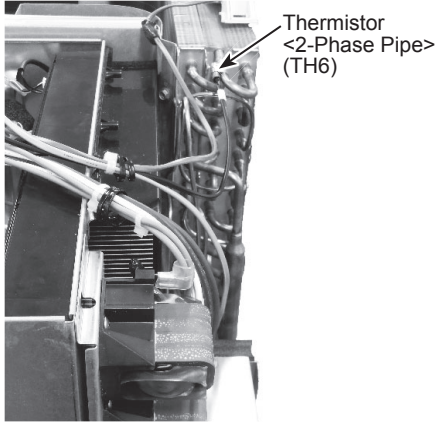
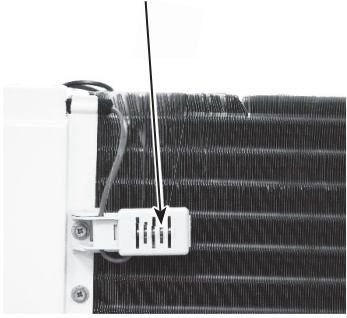
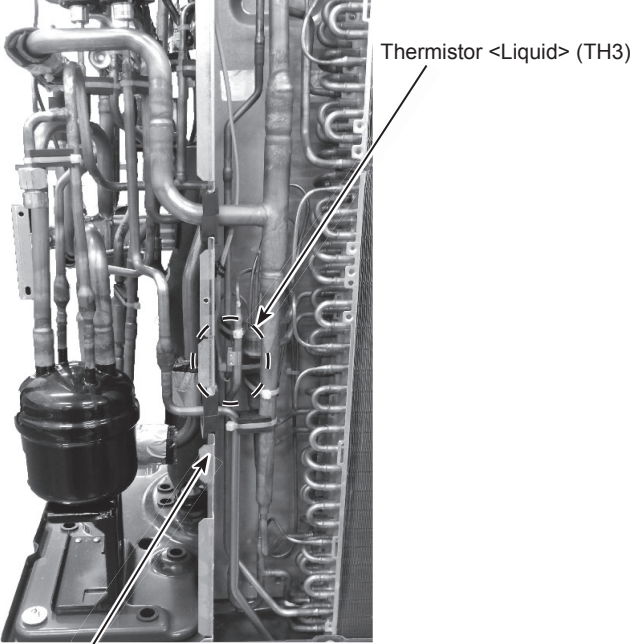
PROCEDURE	PHOTOS/ FIGURES
<p>6. Removing the thermistor <2-Phase Pipe> (TH6)</p> <ol style="list-style-type: none"> (1) Remove the service panel. (See Photo 1) (2) Remove the top panel. (See Photo 1) (3) Disconnect the connector TH7/6 (RD) on the controller circuit board in the electrical parts box. (See Photo 3-1) (4) Loosen the fasteners for the lead wire in the electrical parts box. (5) Loosen the clamp for the lead wire on the rear of electrical parts box. (6) Pull out the thermistor <2-phase pipe> (TH6) from thermistor clip. <p>Note 1: The wiring of thermistor <Liquid>(TH3), thermistor <2-phase pipe> (TH6) and thermistor <Ambient> (TH7), are fixed with a band. When replacing the thermistor, cut the band.</p>	<p>Photo 6</p> 
<p>7. Removing the thermistor <Ambient> (TH7)</p> <ol style="list-style-type: none"> (1) Remove the service panel. (See Photo 1) (2) Remove the top panel. (See Photo 1) (3) Disconnect the connector TH7/6 (RD) on the controller circuit board in the electrical parts box. (See Photo 3-1) (4) Loosen the fasteners for the lead wire in the electrical parts box. (5) Loosen the clamps for the lead wire on rear of electrical parts box. (6) Remove the sensor holder fixing screw (1 for rear/ 5 × 12) to remove the sensor holder. (7) Pull out the thermistor <Ambient> (TH7) from sensor holder. <p>Note 1: The wiring of thermistor <Liquid>(TH3), thermistor <2-phase pipe> (TH6) and thermistor <Ambient> (TH7) are fixed with a band. When replacing the thermistor, cut the band.</p>	<p>Photo 7</p> 
<p>8. Removing the thermistor <Liquid> (TH3)</p> <ol style="list-style-type: none"> (1) Remove the service panel. (See Photo 1) (2) Remove the top panel. (See Photo 1) (3) Remove the cover panel (front). (See Photo 3-1) (4) Remove the cover panel (rear) fixing screws (2 for rear and 2 for right/ 5 × 12) to remove the cover panel (rear). (See Photo 3-1) (5) Remove the valve bed fixing screws (2 for front/ 5 × 12) on the side panel (R). (See Photo 3-1) (6) Remove the electrical parts box fixing screws (2 for front/ 5 × 12). (See Photo 3-1) (7) Remove the sensor holder. (See Photo 7) (8) Remove the side panel (R) fixing screws (3 for rear/ 5 × 12) to remove the side panel (R). (See Photo 1) (9) Disconnect the connector TH3 (WH) on the controller circuit board in the electrical parts box. (See Photo 3-1) (10) Loosen the fasteners for the lead wire in the electrical parts box. (11) Loosen the clamps for the lead wire on the rear of electrical parts box and on the coil cover. (12) Pull out the thermistor <Liquid> (TH3) from thermistor clip. <p>Note 1: The wiring of thermistor <Liquid>(TH3), thermistor <2-phase pipe> (TH6) and thermistor <Ambient> (TH7) are fixed with a band. When replacing the thermistor, cut the band.</p>	<p>Photo 8</p> 

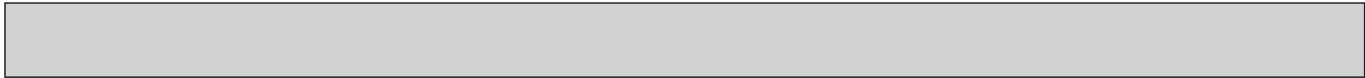

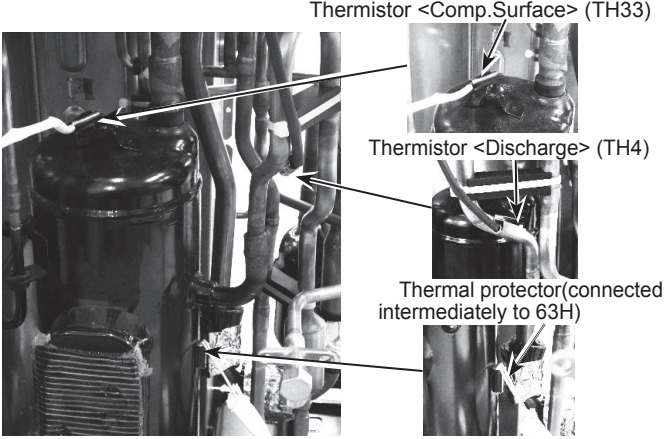
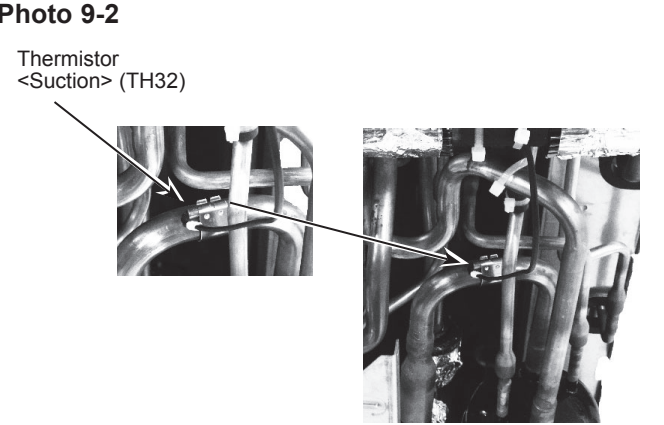
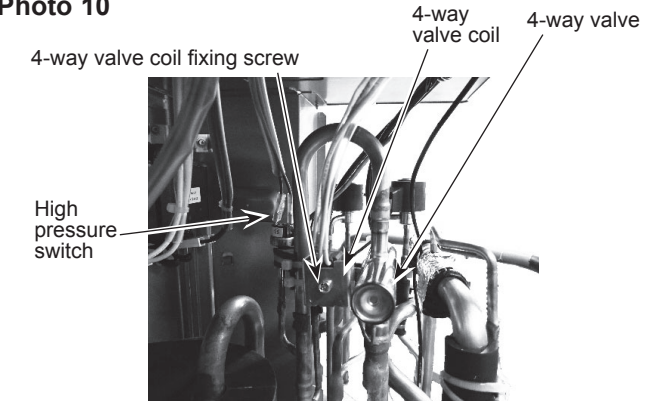
PROCEDURE	PHOTOS/ FIGURES
<p>9. Removing the thermistor <Discharge> (TH4), thermistor <Suction> (TH32), thermistor <Comp. Surface> (TH33) and thermal protector (connected intermediately to 63H)</p> <ol style="list-style-type: none"> (1) Remove the service panel. (See Photo 1) (2) Remove the top panel. (See Photo 1) (3) Remove the cover panel (front). (See Photo 3-1) (4) Disconnect the connectors TH4 (WH), TH32 (BK) and TH33 (YE) from the controller circuit board in the electrical parts box. (See Photo 3-1) Disconnect the relay connector (WH) from the 63H brown cable. (5) Loosen the fasteners, wire clip and cable straps for the lead wire in the electrical parts box. (6) Cut the bands bundling the lead wires. (7) Loosen the clamps for the lead wire on the separator. (8) Pull out the thermal protector from comp thermistor holder. (9) Pull out the thermistor <Discharge> (TH4) from thermistor holder. (10) Pull out the thermistor <Comp. Surface> (TH33) from thermistor holder. (11) Cut the bands fixing the lead wires fixed to the pipes. (12) Detach the thermistor <Suction> (TH32) and its clip from the pipe. 	<p>Photo 9-1</p>  <p>Photo 9-2</p> 
<p>10. Removing the 4-way valve coil (21S4), LEV coils (LEV-A, LEV-B, LEV-C), lead wire for high pressure switch.</p> <ol style="list-style-type: none"> (1) Disconnect the lead wires from the controller circuit board, and remove the electrical parts box. (See Photo 3-1) <p>[Removing the 4-way valve coil]</p> <ol style="list-style-type: none"> (2) Remove the 4-way valve coil fixing screw (1 for front/ M5) to remove the 4-way valve coil. (3) Slide the 4-way valve coil forward to remove it. <p>[Removing the LEV coil]</p> <ol style="list-style-type: none"> (2) Loosen the lead wires fixed to the pipes with bands. (3) Slide the LEV coil upward to remove it. <p>[Removing the lead wire for high pressure switch]</p> <ol style="list-style-type: none"> (2) Disconnect the lead wire from the high pressure switch. 	<p>Photo 10</p> 

PROCEDURE

11. Removing the 4-way valve, LEVs (LEV-A, LEV-B, LEV-C), high pressure switch and high pressure sensor.

- (1) Remove the service panel. (See Photo 1)
- (2) Recover refrigerant.
- (3) Remove the electrical parts box. (See Photo 3-1)
- (4) Remove the valve bed fixing screws (3 for front/ 5 × 12) and the stop valve fixing screws (4 for front/ 5 × 16) to remove the valve bed.
- (5) Remove the cover panel (front). (See Photo 3-1)
- (6) Remove the cover panel (rear). (See Photo 3-1)
- (7) Remove the side panel (R). (See Photo 1)
- (8) Remove the comp felt (top). (See Photo 3-2)
- (9) Remove the comp felt (body). (See Photo 3-2)

[Removing the 4-way valve]

- (10) Remove the 4-way valve coil.
- (11) Remove the welded part of 4-way valve (4 positions) to remove the 4-way valve.

[Removing the LEV]

- (10) Remove the LEV coil.
- (11) Remove the rubber mount fixed with band in between the LEV pipes.
- (12) Remove the welded part of LEV (2 positions) to remove the LEV.

[Removing the pressure switch]

- (10) Disconnect the lead wire from the pressure switch.
- (11) Remove the rubber mount fixed with band in between the pressure switch and pipe.
- (12) Remove the welded part of pressure switch (1 position) to remove the pressure switch.

[Removing the high pressure sensor]

- (10) Remove the rubber parts attached to the high pressure sensor and the fixing bands.
- (11) Remove the welded part of high pressure sensor (1 position) to remove the high pressure sensor.

Note 1: Recover refrigerant without spreading it in the air.

Note 2: When installing the following parts, cover it with a wet cloth to prevent it from heating to the temperature below, then braze the pipes so that the inside of pipes are not oxidized;

- 4-way valve, 248°F (120°C) or more
- LEV, 248°F (120°C) or more
- High pressure switch, 212°F (100°C) or more
- High pressure sensor, 212°F (100°C) or more

Note 3: Be careful not to expose the fusible plug to the braze torch flame or transfer heat to it. Keep the temperature of the fusible plug below 158°F (70°C) during brazing operation, otherwise refrigerant might leak.

PHOTOS/ FIGURES

Photo 11

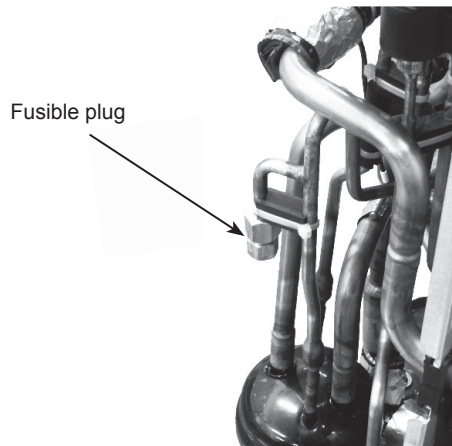
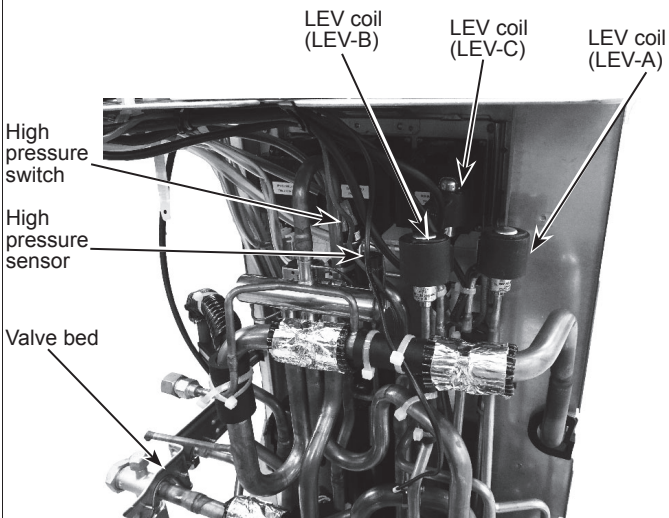
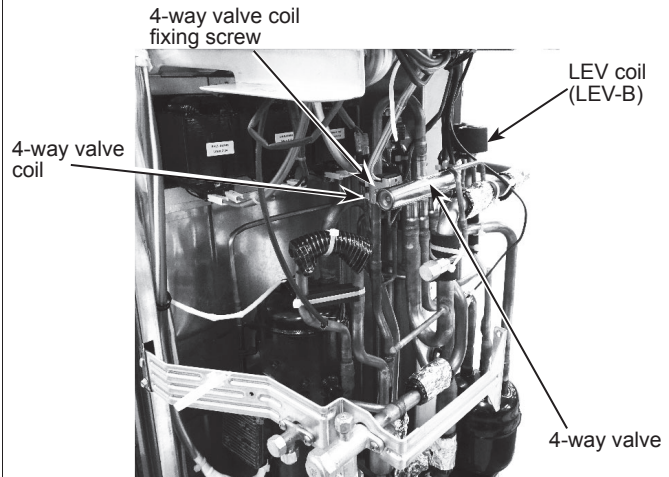

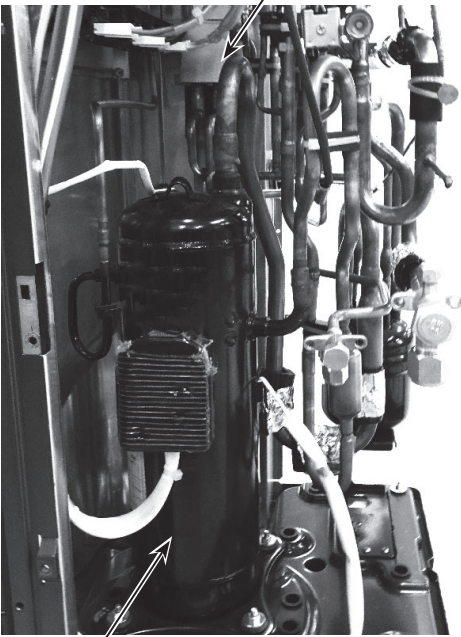
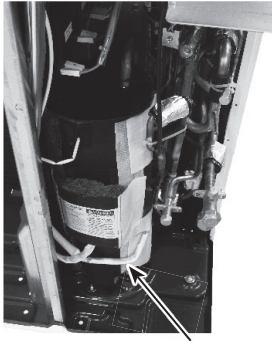
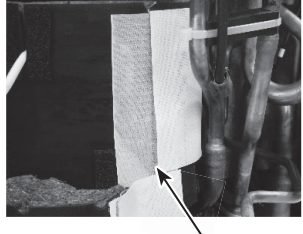

PROCEDURE	PHOTOS/ FIGURES	
<p>12. Removing the compressor (MC)</p> <ol style="list-style-type: none"> (1) Remove the service panel. (See Photo 1) (2) Recover refrigerant. (3) Remove the electrical parts box. (See Photo 3-1) (4) Remove the valve bed. (See Photo 3-1) (5) Remove the cover panel (front). (See Photo 3-1) (6) Remove the cover panel (rear). (See Photo 3-1) (7) Remove the comp felt (top). (See Photo 3-2) (8) Remove the comp felt (body). (See Photo 3-2) (9) Remove the side panel (R). (See Photo 1) (10) Remove the thermistor <Discharge> (TH4), thermistor <Suction> (TH32), thermistor <Comp. Surface> (TH33) and thermal protector. (11) Remove the 4-way valve coil and LEV coil. (12) Disconnect the lead wire from the pressure switch. (13) Remove the hic top support fixing screw (1 for front/ 4 × 10) to remove the hic top support. (14) Remove the welded part (Joint part of the compressor) of piping (3 positions), then slide the piping upward to remove it. (15) Remove the compressor fixing nuts (3 for top/ M6) to remove the compressor. <p>Note 1: Recover refrigerant without spreading it in the air. Note 2: Tighten the nuts of compressor with a torque of 4 ± 0.4 N·m. Note 3: Be careful not to expose the fusible plug to the braze torch flame or transfer heat to it. Keep the temperature of the fusible plug below 158°F (70°C) during brazing operation, otherwise refrigerant might leak.</p>	<p>Photo 12</p> 	
<p>13. Attaching the comp felt</p> <ol style="list-style-type: none"> (1) Remove the service panel. (See Photo 1) (2) Remove the cover panel (front). (See Photo 3-1) (3) Remove the valve bed. (See Photo 3-1) (4) Peel off the hook-and-loop fasteners on the comp felt and remove the comp felt from the compressor. <p>Note 1: Pay attention to the comp felt not to get caught on piping and other components when removing and attaching the felt. Note 2: When attaching the comp felt, wrap it around the compressor gently without any gaps so that the end of fastener tape comes to the left side of the notch (▽) on the compressor felt. (Stitched seam is aligned to the notch (▽). Apply the fastener tape to cover the stitched seam. (See Photo 13-2))</p>	<p>Photo 13-1</p> 	<p>Photo 13-2</p> 

T1 INTRODUCTION

For items not included in this Technical Data, please refer to the Service Manual and Installation Manual.

T2 MAXIMUM OUTLET WATER TEMPERATURE

WUZ-SA24NMZ
WUZ-SA36NMZ
WUZ-SA48NMZ

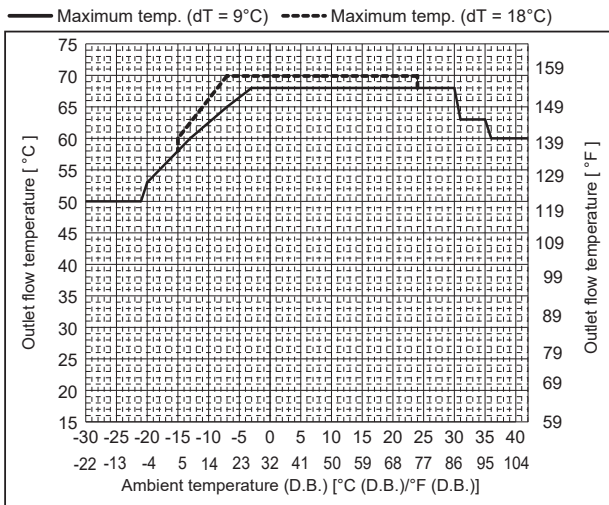

WUZ-SA24/36NMZ

Heating

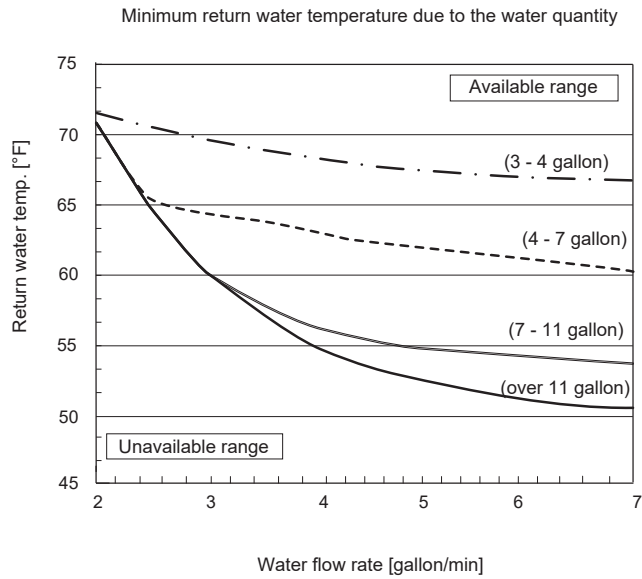

Cooling

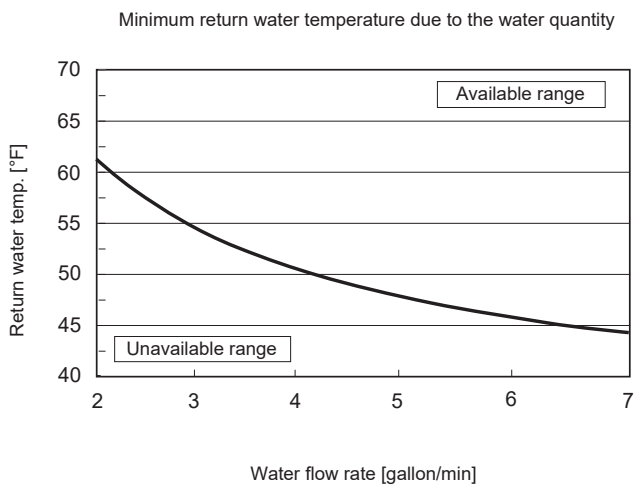

WUZ-SA48NMZ

Heating

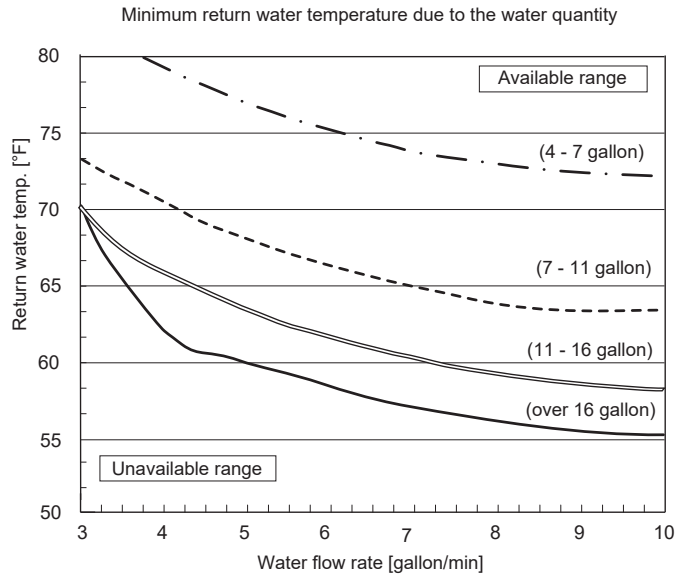

Cooling

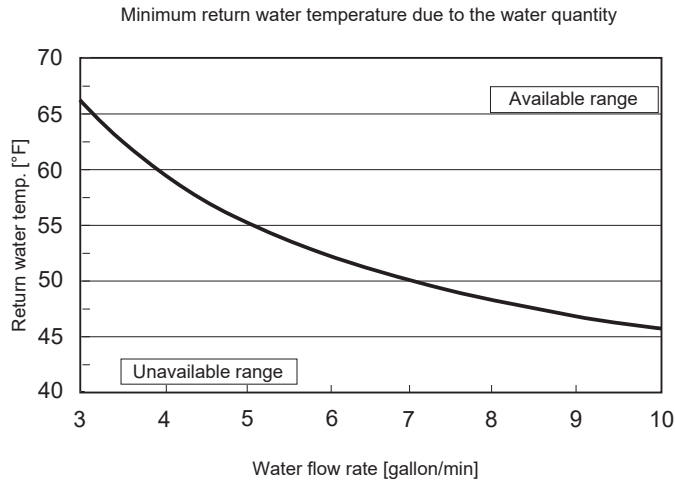

T4-1. Heating

WUZ-SA24NMZ

Water outlet temperature [°C]/[°F]		25/77			35/95			40/104			45/113			50/122			
Ambient temperature [°C]	[°F]	Capacity [kW]	Capacity [kbtu]	COP	Capacity [kW]	Capacity [kbtu]	COP	Capacity [kW]	Capacity [kbtu]	COP	Capacity [kW]	Capacity [kbtu]	COP	Capacity [kW]	Capacity [kbtu]	COP	
Max	-30	-22	-	-	-	5.60	19.11	1.78	5.5	18.77	1.62	5.30	18.08	1.43	4.40	15.01	1.39
	-20	-4	-	-	-	7.60	25.93	2.23	7.5	25.59	1.98	7.30	24.91	1.73	6.30	21.50	1.47
	-15	5	-	-	-	8.80	30.03	2.54	8.5	29.00	2.28	8.20	27.98	1.98	7.10	24.23	1.88
	-10	14	10.30	35.15	3.36	9.70	33.10	2.96	9.4	32.07	2.70	9.10	31.05	2.45	7.80	26.61	2.14
	-7	19.4	10.60	36.17	3.36	10.00	34.12	3.03	9.7	33.10	2.70	9.40	32.07	2.40	8.20	27.98	2.19
	2	35.6	10.10	34.46	3.99	9.50	32.42	3.37	9.3	31.73	3.02	9.00	30.71	2.66	8.70	29.69	2.45
	7	44.6	9.60	32.76	5.47	8.90	30.37	4.65	8.6	29.34	4.11	8.20	27.98	3.50	7.90	26.96	3.14
	12	53.6	10.40	35.49	6.44	9.90	33.78	5.53	9.7	33.10	4.87	9.50	32.42	4.16	9.10	31.05	3.65
	15	59	10.70	36.51	7.05	10.40	35.49	5.93	10.2	34.80	5.27	10.00	34.12	4.56	9.50	32.42	3.90
	20	68	10.90	37.19	8.01	10.80	36.85	6.79	10.6	36.17	6.03	10.40	35.49	5.22	10.20	34.80	4.51
Rated	-30	-22	-	-	-	5.60	19.11	1.78	5.5	18.77	1.62	5.30	18.08	1.43	4.40	15.01	1.39
	-20	-4	-	-	-	7.03	23.99	2.23	7.03	23.99	1.98	7.30	24.91	1.73	6.30	21.50	1.47
	-15	5	-	-	-	7.03	23.99	2.56	7.03	23.99	2.26	7.03	23.99	1.92	7.03	23.99	1.78
	-10	14	7.03	23.99	3.43	7.03	23.99	2.98	7.03	23.99	2.70	7.03	23.99	2.42	7.03	23.99	2.03
	-7	19.4	7.03	23.99	3.62	7.03	23.99	3.01	7.03	23.99	2.70	7.03	23.99	2.37	7.03	23.99	2.17
	2	35.6	7.03	23.99	4.31	7.03	23.99	3.60	7.03	23.99	3.19	7.03	23.99	2.76	7.03	23.99	2.43
	7	44.6	6.00	20.47	5.73	6.00	20.47	5.05	6	20.47	4.41	6.00	20.47	3.70	6.00	20.47	3.24
	12	53.6	6.00	20.47	6.54	6.00	20.47	5.42	6	20.47	4.87	6.00	20.47	4.31	6.00	20.47	3.70
	15	59	6.00	20.47	7.15	6.00	20.47	6.03	6	20.47	5.32	6.00	20.47	4.61	6.00	20.47	4.01
	20	68	6.00	20.47	8.16	6.00	20.47	7.00	6	20.47	6.13	6.00	20.47	5.22	6.00	20.47	4.61
Min	-30	-22	-	-	-	3.60	12.28	1.60	3.5	11.94	1.50	3.40	11.60	1.35	3.00	10.24	1.35
	-20	-4	-	-	-	4.30	14.67	2.35	4.2	14.33	2.10	4.10	13.99	1.80	3.90	13.31	1.50
	-15	5	-	-	-	4.90	16.72	2.55	4.8	16.38	2.30	4.70	16.04	2.00	4.60	15.70	1.75
	-10	14	3.80	12.97	3.60	3.50	11.94	2.85	3.4	11.60	2.55	3.30	11.26	2.20	3.20	10.92	1.90
	-7	19.4	3.80	12.97	3.70	3.50	11.94	2.90	3.4	11.60	2.60	3.20	10.92	2.25	3.10	10.58	2.00
	2	35.6	3.40	11.60	4.60	3.10	10.58	3.60	2.9	9.90	3.20	2.60	8.87	2.75	2.40	8.19	2.05
	7	44.6	2.70	9.21	4.80	2.40	8.19	3.50	2.3	7.85	3.30	2.20	7.51	3.05	2.00	6.82	2.50
	12	53.6	3.30	11.26	5.35	3.00	10.24	4.45	2.8	9.55	4.20	2.60	8.87	3.90	2.20	7.51	3.20
	15	59	3.80	12.97	6.75	3.20	10.92	5.60	3	10.24	4.85	2.80	9.55	4.10	2.40	8.19	3.45
	20	68	4.20	14.33	7.45	3.70	12.62	6.55	3.4	11.60	5.65	3.10	10.58	4.75	2.90	9.90	3.90

Water outlet temperature [°C]/[°F]		55/131			60/141			65/140			70/158			
Ambient temperature [°C]	[°F]	Capacity [kW]	Capacity [kbtu]	COP	Capacity [kW]	Capacity [kbtu]	COP	Capacity [kW]	Capacity [kbtu]	COP	Capacity [kW]	Capacity [kbtu]	COP	
Max	-30	-22	-	-	-	-	-	-	-	-	-	-	-	
	-20	-4	-	-	-	-	-	-	-	-	-	-	-	
	-15	5	6.00	20.47	1.62	5.50	18.77	1.48	-	-	-	-	-	
	-10	14	7.60	25.93	1.99	6.00	20.47	1.51	5.00	17.06	1.45	-	-	
	-7	19.4	7.90	26.96	1.99	6.20	21.16	1.58	5.90	20.13	1.51	5.30	18.08	1.25
	2	35.6	7.60	25.93	1.84	6.60	22.52	1.69	5.70	19.45	1.57	5.40	18.43	1.40
	7	44.6	7.50	25.59	2.63	6.80	23.20	2.33	6.20	21.16	1.97	6.30	21.50	1.61
	12	53.6	8.60	29.34	3.14	7.70	26.27	2.74	7.00	23.88	2.35	6.70	22.86	1.81
	15	59	9.00	30.71	3.50	8.00	27.30	2.99	7.20	24.57	2.48	6.90	23.54	1.99
	20	68	9.70	33.10	3.75	9.10	31.05	3.50	8.50	29.00	2.99	7.90	26.96	2.27
Rated	-30	-22	-	-	-	-	-	-	-	-	-	-	-	
	-20	-4	-	-	-	-	-	-	-	-	-	-	-	
	-15	5	6.00	20.47	1.53	5.50	18.77	1.40	-	-	-	-	-	
	-10	14	7.03	23.99	1.89	6.00	20.47	1.43	5.00	17.06	1.37	-	-	
	-7	19.4	7.03	23.99	1.89	6.20	21.16	1.50	5.90	20.13	1.43	5.30	18.08	1.18
	2	35.6	7.03	23.99	1.74	6.60	22.52	1.60	5.70	19.45	1.49	5.40	18.43	1.33
	7	44.6	4.00	13.65	2.50	4.00	13.65	2.31	4.00	13.65	2.11	5.00	17.06	1.66
	12	53.6	4.00	13.65	3.14	4.00	13.65	2.79	4.00	13.65	2.43	5.00	17.06	1.91
	15	59	4.00	13.65	3.50	4.00	13.65	2.99	4.00	13.65	2.65	5.00	17.06	2.08
	20	68	4.00	13.65	3.80	4.00	13.65	3.45	4.00	13.65	3.10	5.00	17.06	2.33
Min	-30	-22	-	-	-	-	-	-	-	-	-	-	-	
	-20	-4	-	-	-	-	-	-	-	-	-	-	-	
	-15	5	4.50	15.35	1.55	2.80	9.55	1.36	-	-	-	-	-	
	-10	14	3.10	10.58	1.60	3.00	10.24	1.60	2.00	6.82	1.15	-	-	
	-7	19.4	2.90	9.90	1.70	2.80	9.55	1.67	2.00	6.82	1.42	5.00	17.06	1.25
	2	35.6	2.10	7.17	1.80	2.00	6.82	1.92	1.90	6.48	1.55	5.00	17.06	1.41
	7	44.6	1.70	5.80	2.30	1.60	5.46	2.27	1.50	5.12	2.07	5.00	17.06	1.66
	12	53.6	1.80	6.14	2.60	1.80	6.14	2.58	1.70	5.80	2.30	5.00	17.06	1.91
	15	59	1.90	6.48	2.90	1.90	6.48	2.78	1.80	6.14	2.50	5.00	17.06	2.08
	20	68	2.60	8.87	3.30	2.50	8.53	3.38	2.30	7.85	3.05	5.00	17.06	2.33

Rated values are based on the table of specifications. The values in the above table are not guaranteed, as they may vary depending on the operating environment, installation, and operating conditions.

WUZ-SA36NMZ

Water outlet temperature [°C][°F]		25/77			35/95			40/104			45/113			50/122			
Ambient temperature [°C]	[°F]	Capacity [kW]	Capacity [kbtu]	COP	Capacity [kW]	Capacity [kbtu]	COP	Capacity [kW]	Capacity [kbtu]	COP	Capacity [kW]	Capacity [kbtu]	COP	Capacity [kW]	Capacity [kbtu]	COP	
Max	-30	-22	-	-	-	8.00	27.30	2.03	7.90	26.96	1.83	7.70	26.27	1.59	8.00	27.30	1.46
	-20	-4	-	-	-	9.40	32.07	2.18	9.20	31.39	1.98	9.00	30.71	1.78	8.60	29.34	1.57
	-15	5	-	-	-	10.70	36.51	2.54	10.50	35.83	2.23	10.30	35.15	1.93	10.00	34.12	1.88
	-10	14	12.60	42.99	2.85	12.00	40.95	2.64	11.70	39.92	2.49	11.40	38.90	2.29	11.00	37.53	2.03
	-7	19.4	13.50	46.06	2.95	13.20	45.04	2.69	12.90	44.02	2.49	12.60	42.99	2.29	12.20	41.63	2.13
	2	35.6	12.80	43.68	3.52	12.40	42.31	3.23	12.20	41.63	2.96	11.90	40.60	2.66	11.40	38.90	2.35
	7	44.6	11.40	38.90	5.59	10.90	37.19	4.74	10.50	35.83	4.11	10.00	34.12	3.45	9.70	33.10	3.20
	12	53.6	12.90	44.02	6.40	12.20	41.63	5.54	12.00	40.95	4.83	11.70	39.92	4.06	11.10	37.87	3.61
	15	59	13.40	45.72	6.81	13.00	44.36	5.74	12.70	43.33	5.18	12.40	42.31	4.57	11.80	40.26	4.23
20	68	14.20	48.45	7.72	13.80	47.09	6.35	13.50	46.06	5.74	13.10	44.70	5.08	12.50	42.65	4.49	
Rated	-30	-22	-	-	-	8.00	27.30	2.03	7.90	26.96	1.83	7.70	26.27	1.59	7.00	23.88	1.51
	-20	-4	-	-	-	9.40	32.07	2.18	9.20	31.39	1.98	9.00	30.71	1.78	8.60	29.34	1.57
	-15	5	-	-	-	10.60	36.17	2.53	10.60	36.17	2.23	10.00	34.12	1.98	10.00	34.12	1.88
	-10	14	10.60	36.17	3.36	10.60	36.17	2.84	10.60	36.17	2.58	10.60	36.17	2.34	10.60	36.17	2.04
	-7	19.4	10.60	36.17	3.41	10.60	36.17	2.94	10.60	36.17	2.68	10.60	36.17	2.38	10.60	36.17	2.19
	2	35.6	10.60	36.17	4.01	10.60	36.17	3.40	10.60	36.17	3.04	10.60	36.17	2.69	10.60	36.17	2.39
	7	44.6	8.00	27.30	5.99	8.00	27.30	5.05	8.00	27.30	4.42	8.00	27.30	3.71	8.00	27.30	3.30
	12	53.6	8.00	27.30	7.31	8.00	27.30	5.99	8.00	27.30	5.18	8.00	27.30	4.37	8.00	27.30	3.87
	15	59	8.00	27.30	7.67	8.00	27.30	6.30	8.00	27.30	5.59	8.00	27.30	4.88	8.00	27.30	4.38
20	68	8.00	27.30	8.79	8.00	27.30	7.21	8.00	27.30	6.35	8.00	27.30	5.49	8.00	27.30	4.80	
Min	-30	-22	-	-	-	3.60	12.28	1.60	3.50	11.94	1.50	3.40	11.60	1.35	3.00	10.24	1.35
	-20	-4	-	-	-	4.30	14.67	2.35	4.20	14.33	2.10	4.10	13.99	1.80	3.90	13.31	1.50
	-15	5	-	-	-	4.90	16.72	2.55	4.80	16.38	2.30	4.70	16.04	2.00	4.60	15.70	1.75
	-10	14	3.80	12.97	3.60	3.50	11.94	2.85	3.40	11.60	2.55	3.30	11.26	2.20	3.20	10.92	1.90
	-7	19.4	3.80	12.97	3.70	3.50	11.94	2.90	3.40	11.60	2.60	3.20	10.92	2.25	3.10	10.58	2.00
	2	35.6	3.40	11.60	4.60	3.20	10.92	3.60	2.90	9.90	3.20	2.60	8.87	2.75	2.40	8.19	2.05
	7	44.6	2.70	9.21	4.80	2.50	8.53	3.50	2.30	7.85	3.30	2.20	7.51	3.05	2.00	6.82	2.50
	12	53.6	3.30	11.26	5.35	3.00	10.24	4.45	2.80	9.55	4.20	2.60	8.87	3.90	2.20	7.51	3.20
	15	59	3.80	12.97	6.75	3.20	10.92	5.60	3.00	10.24	4.85	2.80	9.55	4.10	2.40	8.19	3.45
20	68	4.20	14.33	7.45	3.70	12.62	6.55	3.40	11.60	5.65	3.10	10.58	4.75	2.90	9.90	3.90	

Water outlet temperature [°C][°F]		55/131			60/141			65/140			70/158			
Ambient temperature [°C]	[°F]	Capacity [kW]	Capacity [kbtu]	COP	Capacity [kW]	Capacity [kbtu]	COP	Capacity [kW]	Capacity [kbtu]	COP	Capacity [kW]	Capacity [kbtu]	COP	
Max	-30	-22	-	-	-	-	-	-	-	-	-	-	-	
	-20	-4	-	-	-	-	-	-	-	-	-	-	-	
	-15	5	9.20	31.39	1.62	7.50	25.59	1.50	-	-	-	-	-	
	-10	14	10.00	34.12	1.94	8.00	27.30	1.61	6.00	20.47	1.42	-	-	
	-7	19.4	10.00	34.12	1.98	9.20	31.39	1.68	8.00	27.30	1.47	6.30	21.50	1.23
	2	35.6	10.40	35.49	2.04	9.40	32.07	1.89	8.50	29.00	1.54	6.40	21.84	1.38
	7	44.6	9.20	31.39	2.58	8.50	29.00	2.32	8.70	29.69	1.91	6.60	22.52	1.59
	12	53.6	10.50	35.83	3.04	9.50	32.42	2.63	9.00	30.71	2.28	8.70	29.69	1.78
	15	59	11.10	37.87	3.66	10.00	34.12	2.99	9.40	32.07	2.44	9.10	31.05	1.96
20	68	11.40	38.90	3.87	10.50	35.83	3.66	9.90	33.78	2.90	11.10	37.87	2.25	
Rated	-30	-22	-	-	-	-	-	-	-	-	-	-	-	
	-20	-4	-	-	-	-	-	-	-	-	-	-	-	
	-15	5	9.20	31.39	1.62	7.50	25.59	1.44	-	-	-	-	-	
	-10	14	10.00	34.12	1.94	8.00	27.30	1.61	6.00	20.47	1.42	-	-	
	-7	19.4	10.00	34.12	2.03	9.20	31.39	1.68	8.00	27.30	1.47	6.30	21.50	1.23
	2	35.6	10.00	34.12	2.09	9.40	32.07	1.89	8.50	29.00	1.54	6.40	21.84	1.38
	7	44.6	7.00	23.88	2.70	7.00	23.88	2.37	7.00	23.88	2.06	6.60	22.52	1.63
	12	53.6	7.00	23.88	3.20	7.00	23.88	2.73	7.00	23.88	2.34	7.00	23.88	1.81
	15	59	7.00	23.88	3.76	7.00	23.88	3.04	7.00	23.88	2.55	7.00	23.88	1.99
20	68	7.00	23.88	3.97	7.00	23.88	3.87	7.00	23.88	2.99	7.00	23.88	2.28	
Min	-30	-22	-	-	-	-	-	-	-	-	-	-	-	
	-20	-4	-	-	-	-	-	-	-	-	-	-	-	
	-15	5	4.50	15.35	1.55	2.80	9.55	1.36	-	-	-	-	-	
	-10	14	3.10	10.58	1.60	3.00	10.24	1.60	2.00	6.82	1.15	-	-	
	-7	19.4	2.90	9.90	1.70	2.80	9.55	1.67	2.00	6.82	1.42	5.00	17.06	1.25
	2	35.6	2.10	7.17	1.80	2.00	6.82	1.92	1.90	6.48	1.55	5.00	17.06	1.41
	7	44.6	1.70	5.80	2.30	1.60	5.46	2.27	1.50	5.12	2.07	5.00	17.06	1.66
	12	53.6	1.80	6.14	2.60	1.80	6.14	2.58	1.70	5.80	2.30	5.00	17.06	1.91
	15	59	1.90	6.48	2.90	1.90	6.48	2.78	1.80	6.14	2.50	5.00	17.06	2.08
20	68	2.60	8.87	3.30	2.60	8.87	3.38	2.30	7.85	3.05	5.00	17.06	2.33	

Rated values are based on the table of specifications. The values in the above table are not guaranteed, as they may vary depending on the operating environment, installation, and operating conditions.

WUZ-SA48NMZ

Water outlet temperature [°C]/[°F]		25/77			35/95			40/104			45/113			50/122			
Ambient temperature [°C]	[°F]	Capacity [kW]	Capacity [kbtu]	COP	Capacity [kW]	Capacity [kbtu]	COP	Capacity [kW]	Capacity [kbtu]	COP	Capacity [kW]	Capacity [kbtu]	COP	Capacity [kW]	Capacity [kbtu]	COP	
Max	-30	-22	-	-	-	9.80	33.44	1.94	9.70	33.10	1.79	9.60	32.76	1.58	10.00	34.12	1.43
	-20	-4	-	-	-	11.80	40.26	2.04	11.70	39.92	1.89	11.50	39.24	1.73	11.30	38.56	1.53
	-15	5	-	-	-	14.20	48.45	2.14	14.10	48.11	2.09	14.00	47.77	1.99	12.90	44.02	1.79
	-10	14	15.50	52.89	2.15	14.90	50.84	2.25	14.80	50.50	2.15	14.60	49.82	2.00	14.50	49.48	1.95
	-7	19.4	16.20	55.28	2.25	15.80	53.91	2.25	15.60	53.23	2.20	15.40	52.55	2.10	15.30	52.21	2.00
	2	35.6	15.60	53.23	2.98	14.60	49.82	2.98	14.50	49.48	2.67	14.30	48.79	2.37	14.20	48.45	2.16
	7	44.6	15.40	52.55	4.18	14.40	49.13	3.57	14.20	48.45	3.32	13.90	47.43	3.01	13.30	45.38	2.64
	12	53.6	16.30	55.62	5.10	15.40	52.55	4.29	15.10	51.52	3.83	14.80	50.50	3.32	14.20	48.45	2.90
	15	59	16.70	56.98	5.61	15.80	53.91	4.95	15.50	52.89	4.54	15.20	51.86	4.08	14.60	49.82	3.56
	20	68	17.90	61.08	5.41	17.00	58.01	5.10	16.70	56.98	4.69	16.40	55.96	4.29	15.70	53.57	3.87
Rated	-30	-22	-	-	-	9.80	33.44	1.94	9.70	33.10	1.79	9.60	32.76	1.58	10.00	34.12	1.43
	-20	-4	-	-	-	11.80	40.26	2.04	11.70	39.92	1.89	11.50	39.24	1.73	11.30	38.56	1.48
	-15	5	-	-	-	14.00	47.77	2.19	14.00	47.77	2.09	14.00	47.77	1.99	12.90	44.02	1.79
	-10	14	14.00	47.77	2.66	14.00	47.77	2.71	14.00	47.77	2.41	14.00	47.77	2.00	14.00	47.77	1.90
	-7	19.4	14.00	47.77	3.02	14.00	47.77	2.77	14.00	47.77	2.51	14.00	47.77	2.25	14.00	47.77	2.00
	2	35.6	14.00	47.77	3.64	14.00	47.77	3.30	14.00	47.77	2.78	14.00	47.77	2.42	14.00	47.77	2.21
	7	44.6	12.00	40.95	5.61	12.00	40.95	4.85	12.00	40.95	4.03	12.00	40.95	3.27	12.00	40.95	2.85
	12	53.6	12.00	40.95	6.73	12.00	40.95	5.66	12.00	40.95	4.90	12.00	40.95	4.08	12.00	40.95	3.46
	15	59	12.00	40.95	7.35	12.00	40.95	6.02	12.00	40.95	5.36	12.00	40.95	4.69	12.00	40.95	4.12
	20	68	12.00	40.95	8.57	12.00	40.95	6.84	12.00	40.95	6.07	12.00	40.95	5.31	12.00	40.95	4.53
Min	-30	-22	-	-	-	4.20	14.33	1.60	4.10	13.99	1.50	4.00	13.65	1.35	4.00	13.65	1.35
	-20	-4	-	-	-	5.10	17.40	2.35	5.00	17.06	2.10	4.90	16.72	1.80	4.70	16.04	1.50
	-15	5	-	-	-	5.80	19.79	2.55	5.70	19.45	2.30	5.60	19.11	2.00	5.50	18.77	1.75
	-10	14	4.00	13.65	3.60	3.80	12.97	2.85	3.70	12.62	2.55	3.60	12.28	2.20	3.50	11.94	1.90
	-7	19.4	4.20	14.33	3.70	3.90	13.31	2.90	3.80	12.97	2.60	3.70	12.62	2.25	3.50	11.94	2.00
	2	35.6	3.90	13.31	4.60	3.50	11.94	3.60	3.40	11.60	3.20	3.20	10.92	2.75	3.00	10.24	2.05
	7	44.6	3.90	13.31	4.80	3.50	11.94	3.50	3.40	11.60	3.30	3.20	10.92	3.05	3.00	10.24	2.50
	12	53.6	4.20	14.33	5.35	3.90	13.31	4.45	3.70	12.62	4.20	3.50	11.94	3.90	3.30	11.26	3.20
	15	59	4.40	15.01	6.75	4.30	14.67	5.60	4.20	14.33	4.85	4.10	13.99	4.10	3.90	13.31	3.45
	20	68	5.20	17.74	7.45	4.80	16.38	6.55	4.60	15.70	5.65	4.40	15.01	4.75	2.90	9.90	3.90

Water outlet temperature [°C]/[°F]		55/131			60/141			65/140			70/158			
Ambient temperature [°C]/[°F]	[°F]	Capacity [kW]	Capacity [kbtu]	COP	Capacity [kW]	Capacity [kbtu]	COP	Capacity [kW]	Capacity [kbtu]	COP	Capacity [kW]	Capacity [kbtu]	COP	
Max	-30	-22	-	-	-	-	-	-	-	-	-	-	-	
	-20	-4	-	-	-	-	-	-	-	-	-	-	-	
	-15	5	11.70	39.92	1.73	10.00	34.12	1.52	-	-	-	-	-	
	-10	14	14.30	48.79	1.84	11.00	37.53	1.49	8.70	29.69	1.36	-	-	
	-7	19.4	15.20	51.86	1.90	11.00	37.53	1.54	9.00	30.71	1.35	8.40	28.66	1.15
	2	35.6	14.00	47.77	2.01	12.00	40.95	1.70	10.50	35.83	1.55	8.90	30.37	1.30
	7	44.6	12.60	42.99	2.42	11.00	37.53	2.14	10.50	35.83	2.10	9.20	31.39	1.55
	12	53.6	13.60	46.41	2.49	12.40	42.31	2.24	12.20	41.63	2.15	11.90	40.60	1.70
	15	59	14.00	47.77	3.05	12.80	43.68	2.64	12.70	43.33	2.55	12.50	42.65	1.75
	20	68	15.00	51.18	3.41	13.80	47.09	2.95	13.10	44.70	2.90	15.00	51.18	2.10
Rated	-30	-22	-	-	-	-	-	-	-	-	-	-	-	
	-20	-4	-	-	-	-	-	-	-	-	-	-	-	
	-15	5	11.70	39.92	1.73	10.00	34.12	1.52	-	-	-	-	-	
	-10	14	14.00	47.77	1.84	11.00	37.53	1.49	8.70	29.69	1.36	-	-	
	-7	19.4	14.00	47.77	1.92	11.00	37.53	1.54	9.00	30.71	1.35	8.40	28.66	1.15
	2	35.6	14.00	47.77	2.01	12.00	40.95	1.70	10.50	35.83	1.55	8.90	30.37	1.30
	7	44.6	7.00	23.88	2.70	7.00	23.88	2.22	7.00	23.88	2.08	7.00	23.88	1.65
	12	53.6	7.00	23.88	3.42	7.00	23.88	3.02	7.00	23.88	2.35	7.00	23.88	1.90
	15	59	7.00	23.88	3.73	7.00	23.88	3.12	7.00	23.88	2.69	7.00	23.88	2.00
	20	68	7.00	23.88	3.83	7.00	23.88	3.42	7.00	23.88	3.10	7.00	23.88	2.25
Min	-30	-22	-	-	-	-	-	-	-	-	-	-	-	
	-20	-4	-	-	-	-	-	-	-	-	-	-	-	
	-15	5	5.40	18.43	1.55	3.80	12.97	1.47	-	-	-	-	-	
	-10	14	3.30	11.26	1.60	3.20	10.92	1.60	3.50	11.94	1.24	-	-	
	-7	19.4	3.20	10.92	1.70	3.10	10.58	1.70	3.90	13.31	1.65	7.00	23.88	1.20
	2	35.6	2.70	9.21	1.80	2.60	8.87	1.80	3.70	12.62	1.75	7.00	23.88	1.37
	7	44.6	2.70	9.21	2.30	2.60	8.87	2.30	3.00	10.24	2.24	7.00	23.88	1.65
	12	53.6	3.00	10.24	2.60	2.90	9.90	2.60	3.20	10.92	2.51	7.00	23.88	1.90
	15	59	3.60	12.28	2.90	3.50	11.94	2.90	3.30	11.26	2.64	7.00	23.88	2.00
	20	68	4.00	13.65	3.30	3.90	13.31	3.30	4.50	15.35	3.05	7.00	23.88	2.25

Rated values are based on the table of specifications. The values in the above table are not guaranteed, as they may vary depending on the operating environment, installation, and operating conditions.

T4-2. Cooling

		Water outlet temperature [°C]/[°F]		7 / 44.6		18 / 64.4	
Model	Ambient temperature [°C]/	[°F]	Capacity	COP	Capacity	COP	
WUZ-SA24NMZ	Max	35	95	8.00	3.23	10.00	4.67
		30	86	8.50	3.89	10.70	5.51
		25	77	8.80	4.14	11.10	5.72
		20	68	9.20	4.53	11.50	6.25
	Rated	35	95	7.03	3.30	7.90	4.95
		30	86	7.03	4.10	7.90	6.05
		25	77	7.03	4.52	7.90	6.74
		20	68	7.03	5.07	7.90	7.81
	Min	35	95	2.20	2.80	3.00	4.28
		30	86	2.30	3.42	3.20	5.23
		25	77	2.40	3.95	3.30	5.83
		20	68	2.50	4.69	3.50	6.75
WUZ-SA36NMZ	Max	35	95	9.20	2.96	12.00	4.16
		30	86	9.80	3.58	12.70	4.90
		25	77	9.90	3.69	13.00	4.96
		20	68	10.10	4.04	13.30	6.31
	Rated	35	95	9.00	3.00	10.00	4.50
		30	86	9.00	3.70	10.00	5.57
		25	77	9.00	3.92	10.00	6.00
		20	68	9.00	4.37	10.00	6.82
	Min	35	95	2.20	2.90	3.00	4.32
		30	86	2.30	3.58	3.20	5.34
		25	77	2.40	3.79	3.20	5.76
		20	68	2.50	4.23	3.50	6.55
WUZ-SA48NMZ	Max	35	95	12.50	2.60	15.00	3.53
		30	86	13.30	2.99	15.90	4.02
		25	77	13.50	3.08	16.20	4.23
		20	68	13.80	3.37	16.70	4.63
	Rated	35	95	12.50	2.62	14.07	3.75
		30	86	12.50	3.13	14.07	4.27
		25	77	12.50	3.22	14.07	4.49
		20	68	12.50	3.54	14.07	4.91
	Min	35	95	3.30	2.97	4.40	4.12
		30	86	3.40	3.55	4.50	4.69
		25	77	3.40	3.65	4.60	4.93
		20	68	3.60	4.01	4.70	5.40

Rated values are based on the table of specifications. The values in the above table are not guaranteed, as they may vary depending on the operating environment, installation, and operating conditions.

T5 PERFORMANCE CHART

WUZ-SA24NMZ

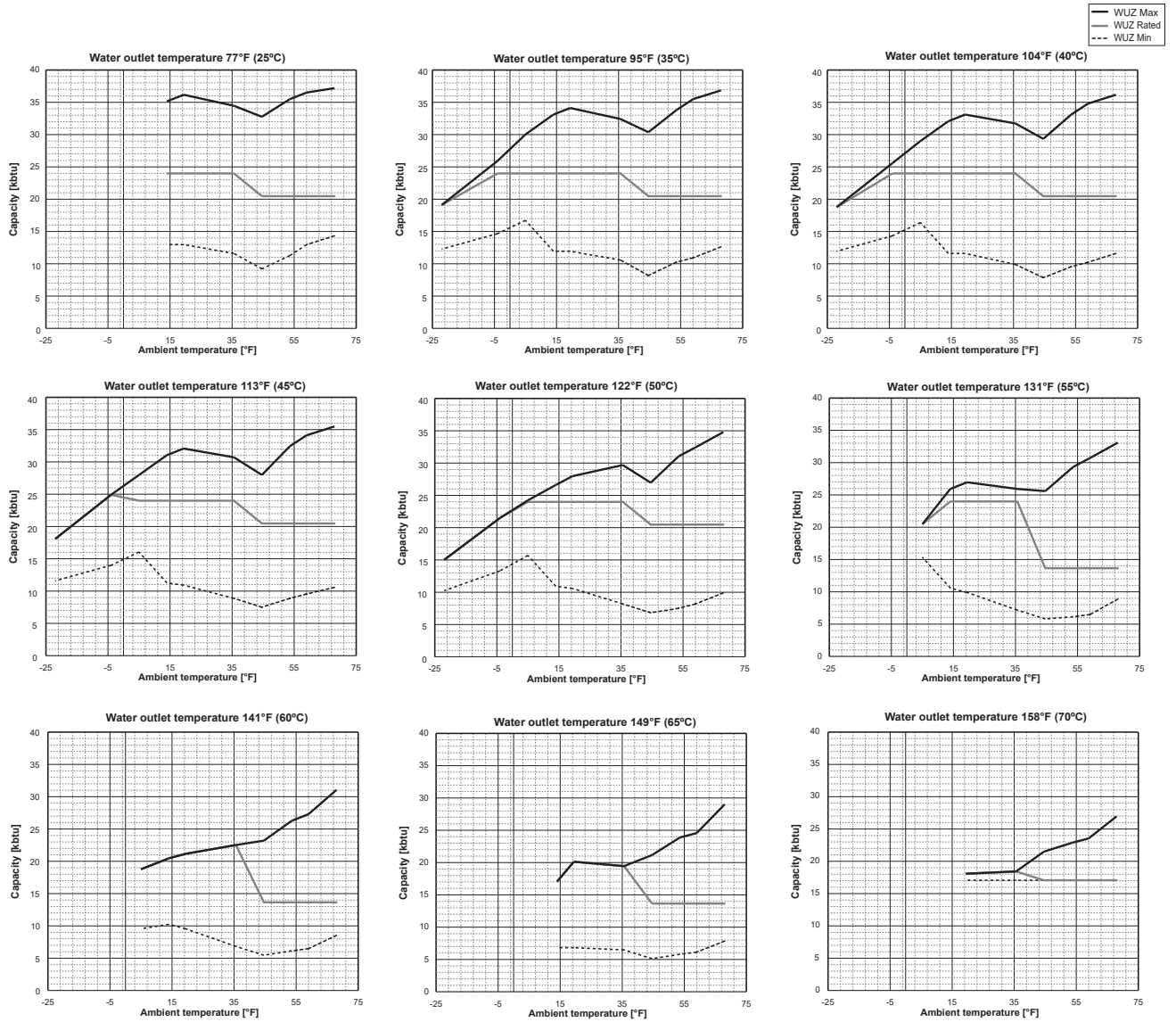

WUZ-SA36NMZ

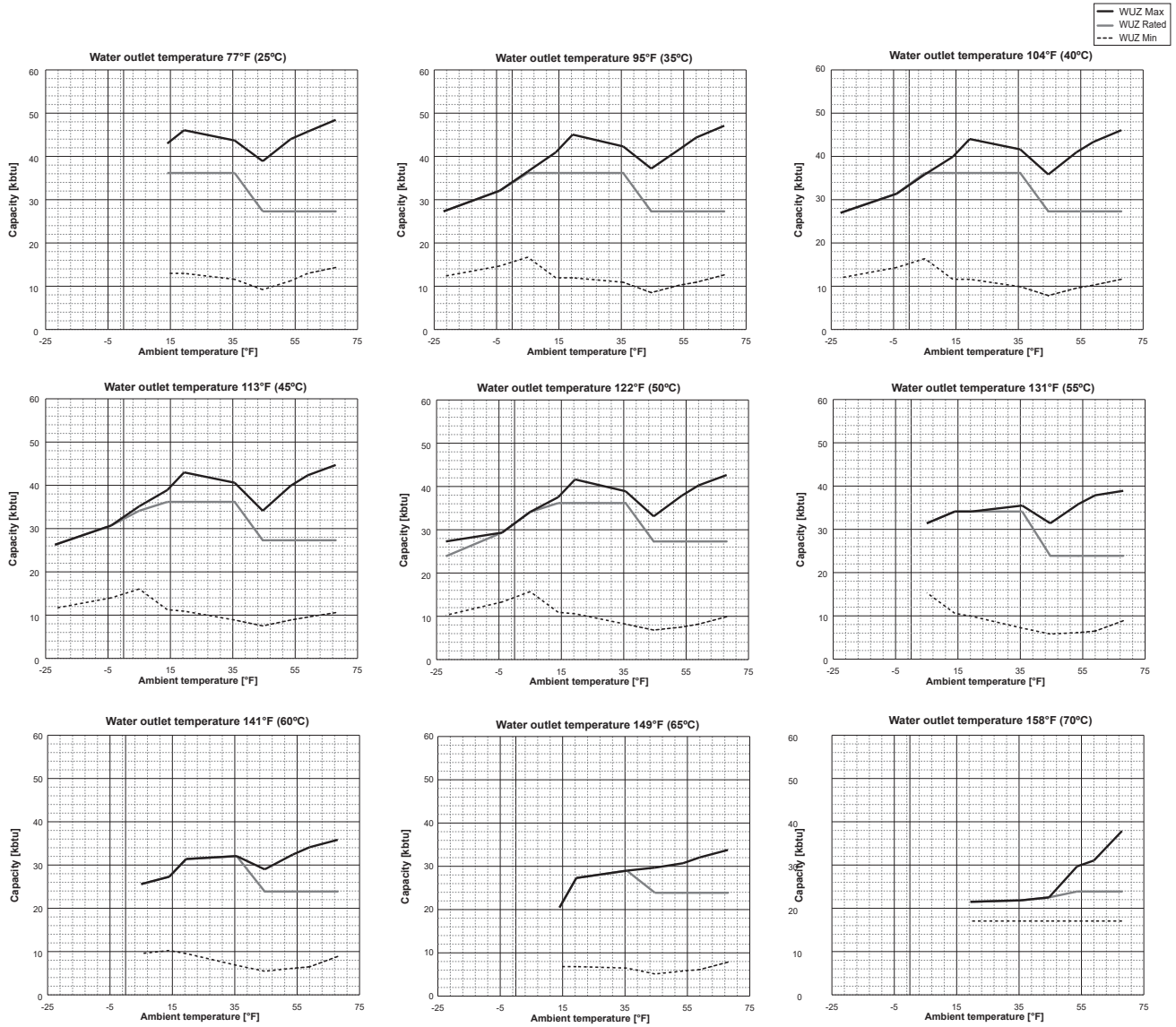

WUZ-SA48NMZ

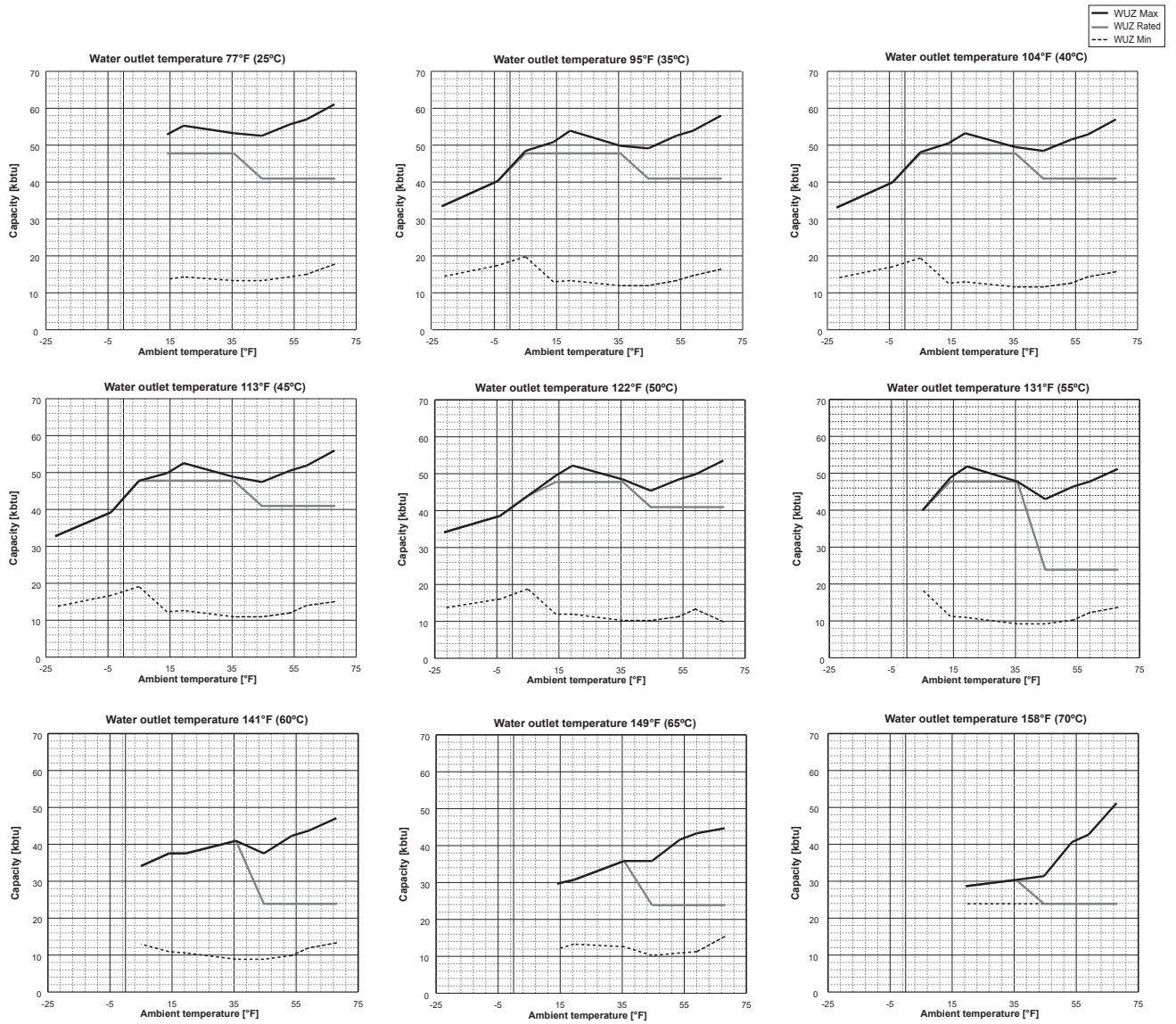

<Method for obtaining the equivalent piping length>

$$\text{Equivalent length} = (\text{piping length}) + 0.3 \times (\text{number of bends in the piping})$$

<Cooling>

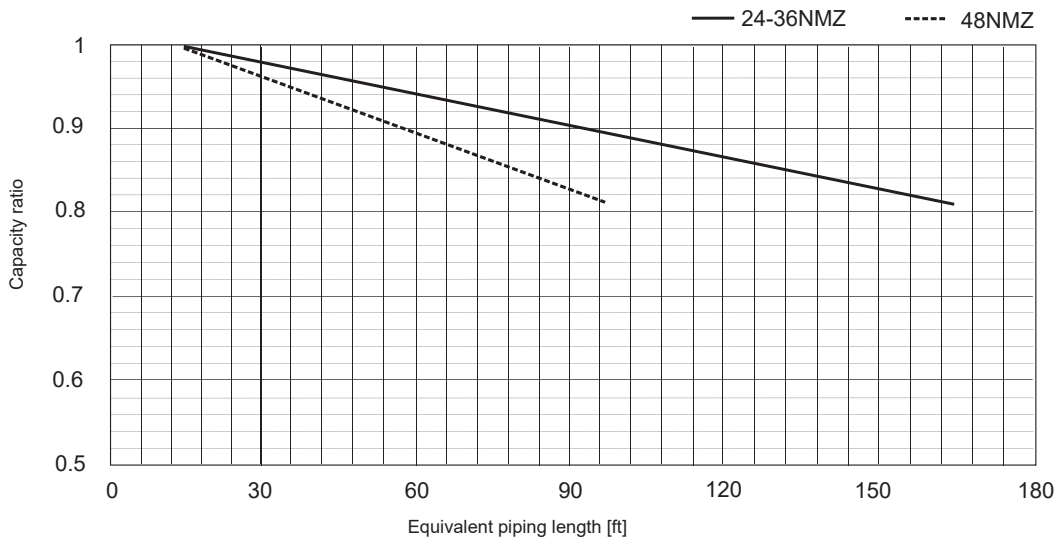

<Heating>

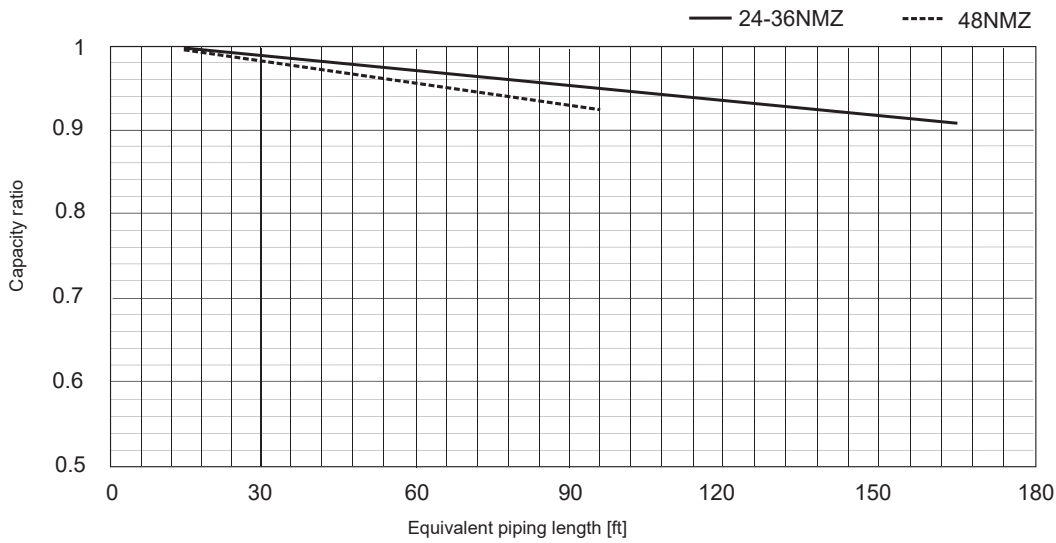

T7 NOISE CRITERION CURVE

Refer to "4-3. NOISE CRITERION CURVE" in service manual.

T8 REFRIGERANT CIRCUIT DIAGRAM

Refer to "8. REFRIGERANT CIRCUIT DIAGRAM" in service manual.

T9 OPTIONAL PARTS

Parts name	Parts No.
AIR PROTECTION GUIDE	PAC-SH95AG-E
AIR DISCHARGE GUIDE	PAC-SH96SG-E
ATTACHMENT (AIR DISCHARGE GUIDE/AIR PROTECTION GUIDE)	PAC-SJ82AT-E
CONTROL/SERVICE TOOL	PAC-SK52ST

MITSUBISHI ELECTRIC CORPORATION

HEAD OFFICE: TOKYO BUILDING, 2-7-3, MARUNOUCHI, CHIYODA-KU, TOKYO 100-8,310, JAPAN
