



OPERATING INSTRUCTIONS

MSH09TW
MSH12TN
MSH15TN
MSH17TN

Mr. SLIM

For customers

Thank you very much for purchasing this Mitsubishi room air conditioner.

- To use this unit correctly and safely, be sure to read this operating instructions before use. Keep this manual carefully for later reference.
- Be sure to receive a guarantee card from your dealer and check that the purchased data and shop name, etc. are entered correctly.
- This air conditioner should not be installed by the customer. (Safety and performance functions cannot be assured.)

CONTENTS

SAFETY PRECAUTIONS	2
NAME OF EACH PART	4
PREPARATION BEFORE OPERATION	6
I FEEL... AUTO OPERATION	7
MANUAL OPERATION (COOL, DRY, HEAT)	8
AIR FLOW VELOCITY AND DIRECTION ADJUSTMENT	9
TIMER OPERATION (ON/OFF TIMER)	10
WHEN THE AIR CONDITIONER IS NOT GOING TO BE USED FOR A LONG TIME	10
MAINTENANCE	11
CLEANING THE AIR FILTER/DEODORIZING FILTER (OPTION)	11
REPLACEMENT OF THE DEODORIZING FILTER (OPTION)/ AIR CLEANING FILTER (OPTION)	12
BEFORE CONTACTING THE SERVICEMAN, CHECK THE FOLLOWING AGAIN	12
WHEN YOU THINK THAT TROUBLE HAS OCCURRED	13
INSTALLATION, RELOCATION AND INSPECTION	14



SAFETY PRECAUTIONS

- Since rotating parts and parts which could cause an electric shock are used in this product, be sure to read these "Safety Precautions" before use.
- Since the cautionary items shown here are important for safety, be sure to observe them. Marks and their meanings are as shown below.

 WARNING	Incorrect handling could cause a serious hazard, such as death, serious injury, etc. with a high probability.
 CAUTION	Incorrect handling could cause a serious hazard depending on the conditions.

Meanings of symbols used in this manual are as shown below.

	Be sure not to do.
	Be sure to follow the instruction.
(Black)	Never insert your finger or stick, etc.
(Black)	Never step onto the indoor/outdoor unit and do not put anything on them.
(Yellow)	Danger of electric shock, be careful.
(Blue)	Be sure to shut off the power.

- After reading this manual, keep it together with the installation manual in a handy place for easy reference.

Warning mark positions and safety devices

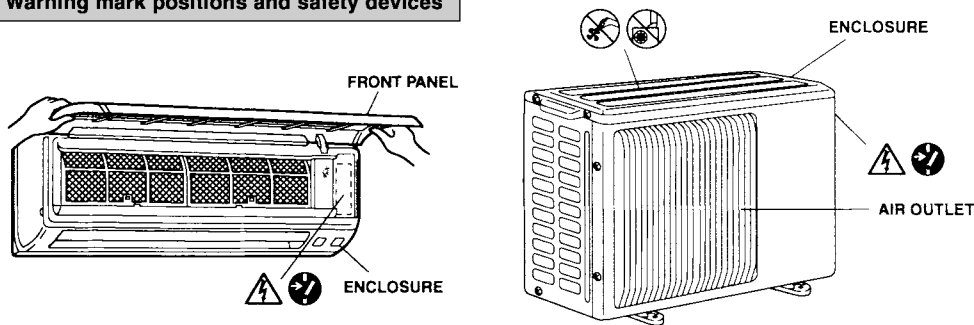

⚠ WARNING

- This air conditioner is NOT intended for use by children or infirm persons without supervisions.

Do not turn the breaker off/on during operation.

- This may cause a fire due to spark, etc.
- Be sure to turn off the breaker absolutely after switching the indoor unit off with the remote controller.

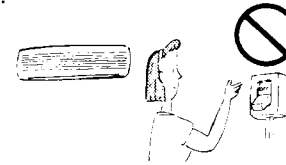

Do not expose your skin directly to cool air for a long time.

- This could damage your health.

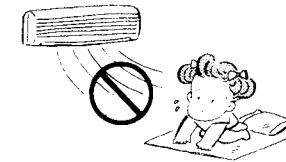

When an abnormality (burning smell, etc.) occurs, stop the air conditioner and turn off the breaker.

- If the unit continues to be operated in an abnormal condition, it may cause a fire, trouble, etc. In this case, consult your dealer.

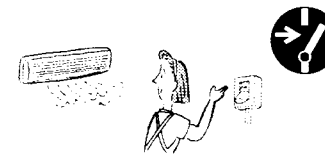

Do not insert your finger or a stick, etc. into the air inlet/outlet.

- Since the fan rotates at high speed, this may cause an injury.
- Young children should be supervised to ensure that they do not play with the air conditioner.

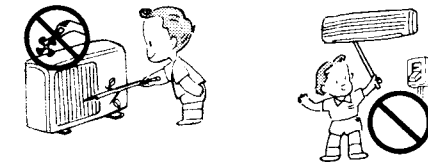

Repair or relocation should not be done by the customer.

- If this is done incorrectly, it may cause a fire, an electric shock, or injury from the unit falling, water leaking, etc. Consult your dealer.



The customer should not install this unit.

- If this is done incorrectly, it may cause a fire, an electric shock, or injury from the unit falling, water leaking, etc. Consult your dealer.

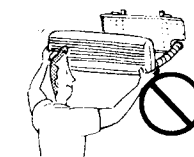



SAFETY PRECAUTIONS

⚠ CAUTION

When the air filter is to be removed, do not touch the metal parts of the indoor unit.

- This may cause an injury.

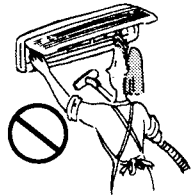

When the unit is to be cleaned, switch it off and turn off the breaker.

- Since the fan rotates at high speed during operation, this may cause an injury.

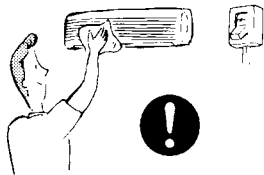

Do not operate switches with wet hands.

- This may cause an electric shock.



Do not clean the air conditioner with water.

- Water may enter the unit and degrade the insulation. This may cause an electric shock.

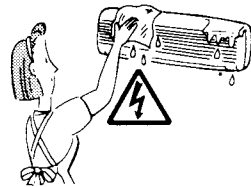

Do not put a pet or houseplant where it will be exposed to direct airflow.

- This could injure the pet or plant.

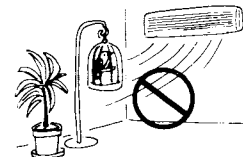

Do not use an insecticide or flammable spray.

- This may cause a fire or deformation of the cabinet.

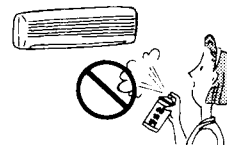

Ventilate well in using the unit with a stove, etc.

- An oxygen shortage may occur.

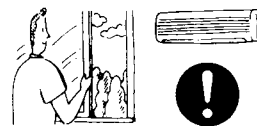

Do not use the unit for special purposes.

- Do not use this air conditioner to preserve precision devices, food, animals, plants and art objects. This may cause deterioration of quality, etc.

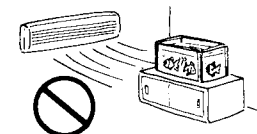

Do not put a stove, etc. where they are exposed to direct airflow.

- This may cause imperfect combustion.

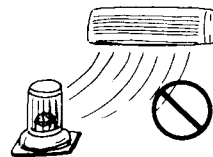

When the unit is not going to be used for a long time, turn off the breaker.

- Otherwise, dirt may collect and this may cause a fire.

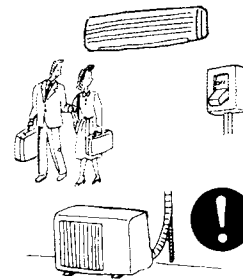

Do not step or put anything on the indoor/outdoor unit.

- This may cause an injury, etc. if you fall down.

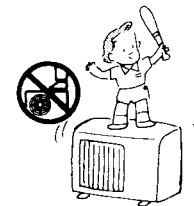

Do not leave the unit on an installation stand which is damaged.

- The unit may fall and this may cause an injury.

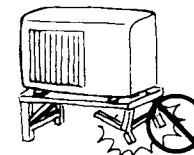

Do not operate the unit for a long time in high humidity, e.g. leaving a door or window open.

- In the cooling mode, if the unit is operated in a room with high humidity (80% RH or more) for a long time, water condensed in the air conditioner may drop and wet or damage furniture, etc.

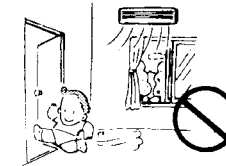

Do not step onto an unstable bench when maintaining the unit, etc.

- This may cause an injury, etc. if you fall down.



Replace the 2 batteries with new ones of same type.

- Using an old battery together with a new one may result in heat generation, leakage or an explosion.



Do not charge or disassemble the batteries and do not throw them into a fire.

- This may result in leakage, fire or an explosion.



If liquid from the alkaline batteries gets onto your skin or clothes, wash it well with clean water.

- If liquid from the alkaline batteries gets into your eyes, wash them well with clean water and consult a doctor at once.

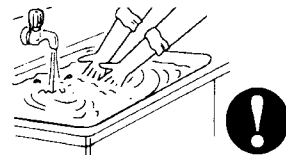



SAFETY PRECAUTIONS

For installation

⚠ WARNING

- Consult your dealer for installation of the air conditioner.

⚠ CAUTION

Ground the unit.

- Do not connect the ground to a gas pipe, water pipe, lightning rod or the ground of a telephone. If the grounding is incorrect, it may cause an electric shock. 

Do not install the unit where flammable gas could leak.

- If gas leak and collect around the unit, it may cause an explosion.



If the air conditioner is installed in a high humidity area or near a water source, a Ground Fault Interrupt (GFI) circuit breaker should be installed to protect against shock. 

Drain should be fully drained.

- If the drainage route is incomplete, water may drop from the unit. This may wet and damage the furniture. 

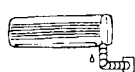

NAME OF EACH PART

Indoor unit

MSH09TW

Air cleaning filter (White bellows type) (OPTION)

Deodorizing filter (Gray sponge type) (OPTION)

Air filter

Vertical vane

Horizontal vane

Front panel

Air inlet

Remote control receiving section

Remote controller

MSH12/15/17TN



Operation section

(When the front panel is opened)

MSH09TW



Emergency operation switch

MSH12/15/17TN



Emergency operation switch

Display section

MSH09TW



Operation Indicator lamp

Receiving section

MSH12/15/17TN



MITSUBISHI ELECTRIC SLIM

Operation indicator

Operation Indicator lamp

Receiving section

Outdoor unit

MUH09TW, MUH12TN

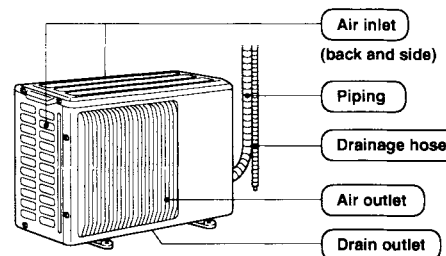

Air inlet (back and side)

Piping

Drainage hose

Air outlet

Drain outlet

MUH15TN

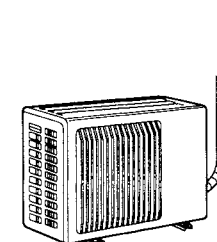

MUH17TN

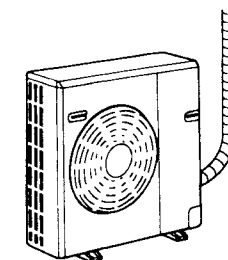



NAME OF EACH PART

Remote controller

Signal transmitting section

Operation display section

ON/OFF (operate/stop) button

Temperature buttons

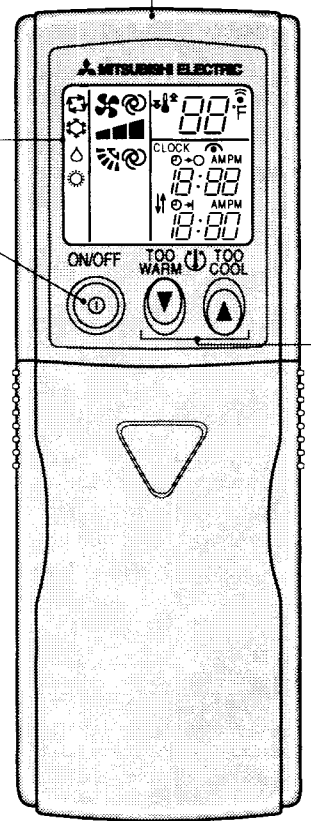

(This diagram shows an overall view.)

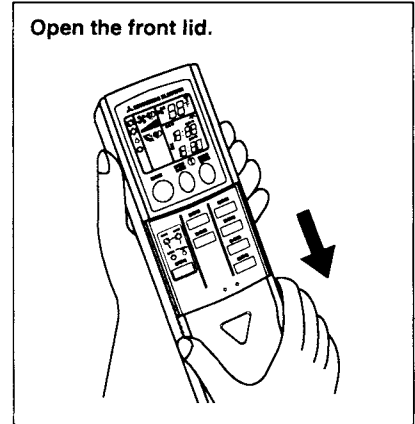

Fan speed control button

Operation select button

RESET button

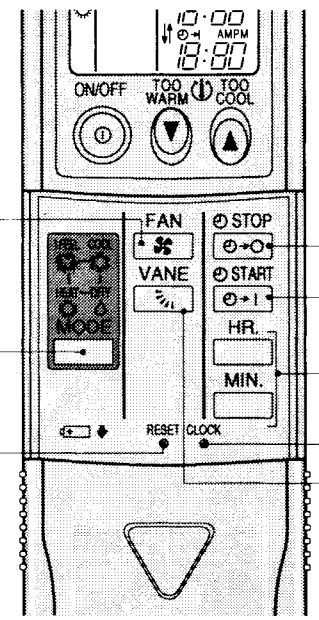

Off-timer button

On-timer button

HR.button
MIN.button
(Time set button)

CLOCK set button

Vane control button



PREPARATION BEFORE OPERATION

Auto restart function

These models are equipped with an auto restart function. If you do not want to use this function, please consult the service representative because the setting of the unit needs to be changed.

Auto restart function is ...

When the indoor unit is controlled with the remote controller, the operation mode, the set temperature and the fan speed are stored in the memory. If a power failure occurs or the main power is turned off during operation, "Auto restart function" sets automatically to start operating in the same mode as the one set with the remote controller just before the shutoff of the main power. (Refer to page 7 for details.)

Breaker for the air conditioner

Turn the breaker on.

Remote controller (How to set the batteries and the current time)

1 Remove the front lid and insert batteries. Then reattach the front lid.

Insert the minus pole of the batteries first. Check if the polarity of the batteries is correct.

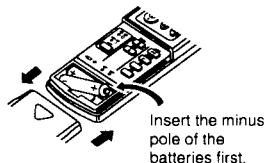

2 Press the RESET button.

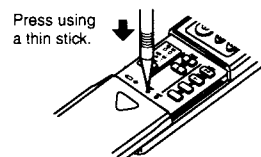

■ If the RESET button is not pressed, the remote controller may not operate correctly.

3 Press the CLOCK set button.

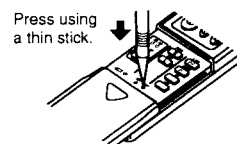

4 Press the **HR.** and **MIN.** button (TIME SET button) to set the current time.

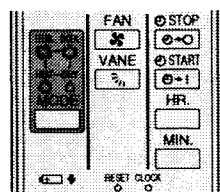

■ Each time the **HR.** button is pressed, the set time increases by 1 hour, and each time the **MIN.** button is pressed, the set time increases by 1 minute.

5 Press the CLOCK set button again and close the front lid.

Handling of the remote controller

- The range that the signal can reach is about 20 feet when the remote controller is pointed at the front of the indoor unit.
- When a button is pressed, one or two beeps will be heard from the indoor unit. If no sound is heard, operate again.
- Use the remote controller carefully. If it is dropped, thrown or it gets wet, the remote controller may not operate.

When installing on a wall, etc.

- Install the remote controller installation case in a position where the signal reception sound (beep) can be heard from the indoor unit when the button is pressed.

How to install/remove the remote controller

- Installing** Insert the remote controller downward.
- Removing** Pull it up.

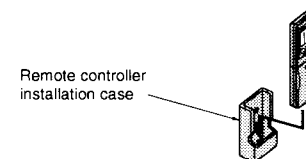

Dry-cell batteries

Reference for replacing batteries

When the indoor unit does not respond to the signal from the remote controller, or the display becomes dim, replace the batteries with new ones (size AAA).

- Though both alkaline batteries and manganese batteries can be used, alkaline batteries are recommended because their service life is longer than that of manganese batteries.
- The service life of an alkaline battery is about 1 year. However, a battery which the time limit is approaching may be exhausted soon. The recommended usable time limit is indicated (month/year) on the bottom of the battery.
- Replace the 2 batteries with new ones of the same type.
- Do not use rechargeable batteries.
- To prevent liquid leakage, take out all batteries when the remote controller is not going to be used for a long time.
- Dispose of exhausted batteries in the correct manner.

When the remote controller cannot be used (emergency operation)

When the batteries of the remote controller run out or the remote controller malfunctions, the emergency operation can be done using the EMERGENCY OPERATION switch.

1 Press the EMERGENCY OPERATION switch.

- * Each time the EMERGENCY OPERATION switch is pressed, the unit will operate in order of EMERGENCY COOL MODE, EMERGENCY HEAT MODE and STOP MODE. However, when the EMERGENCY OPERATION switch is once pressed, the unit will operate in test run for 30 minutes and then the operation mode shifts to EMERGENCY MODE.

MSH09TW

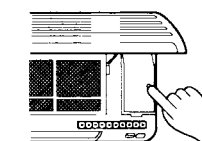

MSH12/15/17TN

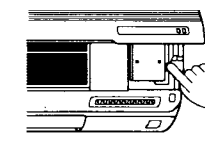

Details of EMERGENCY MODE are as shown below. However, the temperature control does not work for 30 minutes in test run and the unit is set to continuous operation. The fan speed is set to Hi in test run and shifts to Medium after 30 minutes.

Operation mode	COOL	HEAT
Set temperature	75 °F	75 °F
Fan speed	Medium	Medium
Horizontal vane	Auto	Auto

The operation mode is indicated by the Operation Indicator lamp on the indoor unit as following figures.

Operation Indicator lamp

MSH09TW

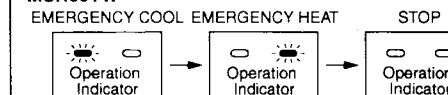

MSH12/15/17TN

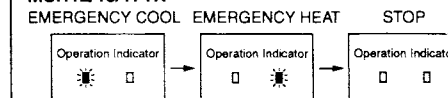

■ To stop the emergency operation, press the EMERGENCY OPERATION switch once (in case of EMERGENCY HEAT MODE) or twice (in case of EMERGENCY COOL MODE).



I FEEL... AUTO OPERATION

With the "I FEEL..." auto operation mode, the optimum room condition can be set automatically with a one-touch operation.

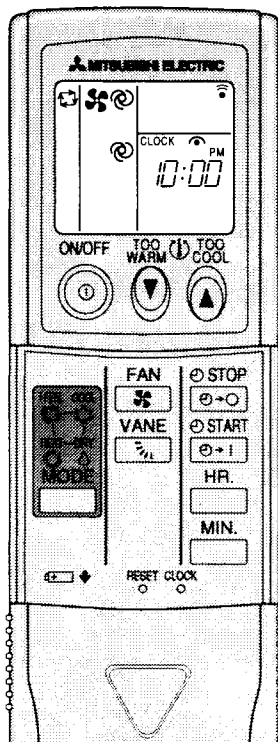

To start operation:

Press the **ON/OFF** button.

When the "I FEEL..." mode is selected, the air conditioner is automatically controlled at the optimum temperature.

To stop operation:

Press the **ON/OFF** button.

If you feel slightly warm:

Press the **TOO WARM** button to lower the temperature.

One press lowers the temperature by about 2 °F.

If you feel slightly cool:

Press the **TOO COOL** button to raise the temperature.

One press raises the temperature by about 2 °F.

When "I FEEL..." is not selected, press the **MODE** button until it is set.

Each time the button is pressed, the operation mode is changed in sequence: I FEEL... → COOL → DRY → HEAT

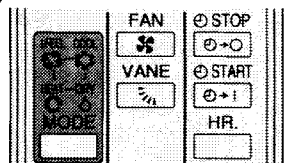

NOTE

COOL: When the room temperature is 4 °F higher than the set temperature, the set temperature may not be changed since the air conditioner is operating to reach the target (set) temperature. In this case, please wait until the room temperature drops to within 4 °F of the set temperature and then change the set temperature.

HEAT: When the room temperature is 4 °F lower than the set temperature, the set temperature may not be changed since the air conditioner is operating to reach the target (set) temperature. In this case, please wait until the room temperature rises to within 4 °F of the set temperature and then change the set temperature.

Details of display on the indoor unit

The operation indicator at the right side of the indoor unit indicates the operation state.

MSH09TW

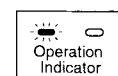

Lighted
Blinking
Not lighted

MSH12/15/17TN

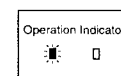

Lighted
Blinking
Not lighted

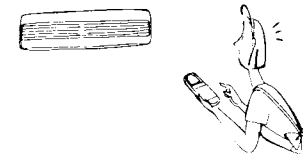

Operation indicator lamp

The following indication does not depend on the shape of lamp.

Indication	Operation state	Difference between target temperature and room temperature
	This shows that the air conditioner is operating to reach the target temperature. Please wait until the target temperature is obtained.	About 4 °F or more
	This shows that the room temperature is approaching the target temperature.	About 4 °F or less
	(In case of outdoor unit MXZ series only) Please refer to INFORMATION FOR MULTI SYSTEM AIR CONDITIONER (page 8).	—

Description of "I FEEL..." mode

Details of operation

According to the room temperature when the operation starts, the operation mode is automatically set to COOL, DRY or HEAT. However, when operation is started again within 2 hours after it is stopped, the same operation mode before the operation is stopped is selected. The operation mode selected first is not changed even if the room temperature changes. If the operation mode does not match the room condition, select the appropriate operation mode by pressing the **MODE** button.

Details of auto operation

Room temperature when started	Operation mode	Target temperature (initial state)
About 77 °F or higher	COOL	About 75 °F
About 77 °F - 73 °F	DRY	—
About 73 °F or lower	HEAT	About 79 °F

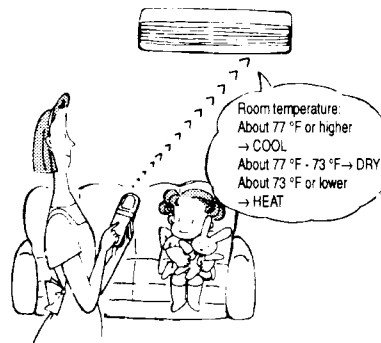

Description of "AUTO RESTART FUNCTION"

- These units are equipped with an auto restart function. When the main power is turned on, the air conditioner will start operation automatically in the same mode as the one set with the remote controller before the shutoff of the main power.
- If the unit was set to off with the remote controller before the shutoff of the main power, it will remain stopped even after the main power is turned on.
- If the unit was in the emergency operation before the shutoff of the main power, it will start operation, when main power comes on, in the same mode as the one set with the remote controller before the emergency operation.
- If the unit is operated in "I FEEL ..." mode before power failure, the operation is not stored in the memory. In "I FEEL ..." mode, the operation is decided by the initial room temperature at (re)start.
- Since the air conditioner has been shipped from the factory with the COOL mode saved in the memory for auto restart function, it starts cooling operation when the user turns on the main power for the first time after installation.

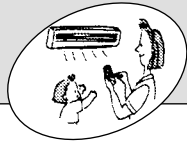

MANUAL OPERATION (COOL, DRY, HEAT)

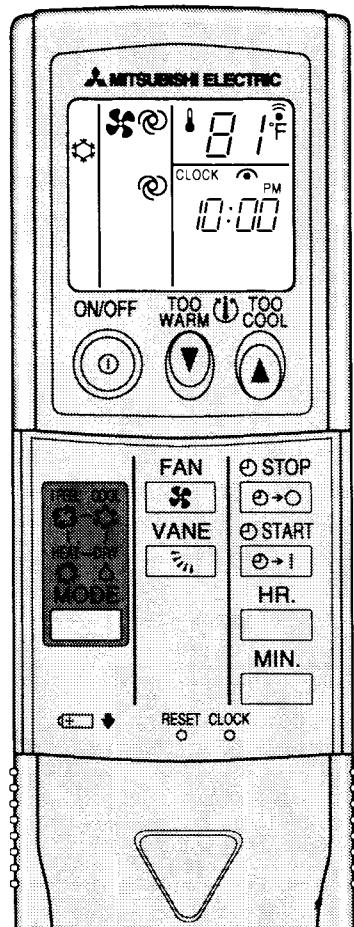

To select the COOL, DRY or HEAT mode

- 1 Press the button.
- 2 Select the operation mode by pressing the button.

Each time this button is pressed, the operation mode is changed in sequence: (I FEEL...) → (COOL) → (DRY) → (FAN)

To stop operation:

- 1 Press the button.

After the operation mode is set once, the operation starts in the mode set previously from the next time by simply pressing the button.

When the set temperature is to be changed:

- Press the button to lower the temperature. One press lowers the temperature by about 2 °F.
- Press the button to raise the temperature. One press raises the temperature by about 2 °F.

In HEAT operation

- If the air conditioner absorbs too much heat from the air, it may be overloaded. Following a judgement made by the microprocessor, the fan in the outdoor unit is automatically stopped to protect the air conditioner. When the outdoor unit's fan is stopped, frost may form on the outdoor unit, but this is not a problem.

In DRY operation

- The temperature control (temperature setting) cannot be done.
- The room temperature is slightly lowered in this operation mode.

The details of the display on the indoor unit are explained on page 7.

NOTE

When the ambient temperature is too high, the room temperature may not reach the set temperature since the unit operates to cool under high load.

CONVENIENT INFORMATION

COOL For effective cooling

- ① Close the windows and pull down blinds. Sunshine is reduced and cooling efficiency increases.
- ② Paste a heat shield film (generally available) on the window. Heat entering the room is reduced.
- ③ Block the outdoor unit from direct sunlight. This saves energy.

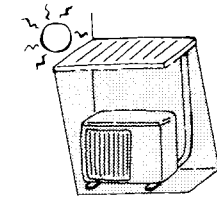
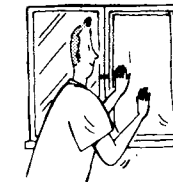
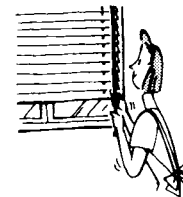

HEAT Comfortable warmth depends on the temperature difference between the indoor and the outdoor.

It is recommended that the set temperature in the heating operation does not differ from the external temperature too much. Though there is a regional difference, as a reference, a set temperature between about 72 °F and 75 °F is most suitable.

DRY The humidity at which people feel comfortable

When air contains too much moisture, people feel uncomfortable. Humidity is related to temperature and wind. The humidity at which people feel comfortable is 60 % - 75 % RH in summer, 55 % - 70 % RH in winter.

INFORMATION FOR MULTISYSTEM AIR CONDITIONER (OUTDOOR UNIT: MXZ SERIES)

Multi system air conditioner (Outdoor unit: MXZ series) can connect two or more indoor units with one outdoor unit. According to the capacity, two or more units can operate simultaneously.

- When you try to operate two or more indoor units with one outdoor unit simultaneously, one for the cooling and the other for heating, the operation mode of the indoor unit that operates earlier is selected. The other indoor units that will start the operation later cannot operate, indicating an operation state. (Refer to the table of Operation Indicator lamp on page 7.) In this case, please set all the indoor units to the same operation mode.
- When indoor unit starts the operation while the defrosting of outdoor unit is being done, it takes a few minutes (max. 10 minutes) to blow out the warm air.
- In the heating operation, the indoor unit that does not operate may get warm or the sound of refrigerant flowing may be heard. This is not a malfunction since the refrigerant continuously flows into the indoor unit that does not operate.

Description of "AUTO RESTART FUNCTION"

Refer to page 7.



AIR FLOW VELOCITY AND DIRECTION ADJUSTMENT

AIR FLOW velocity and direction can be selected as required.

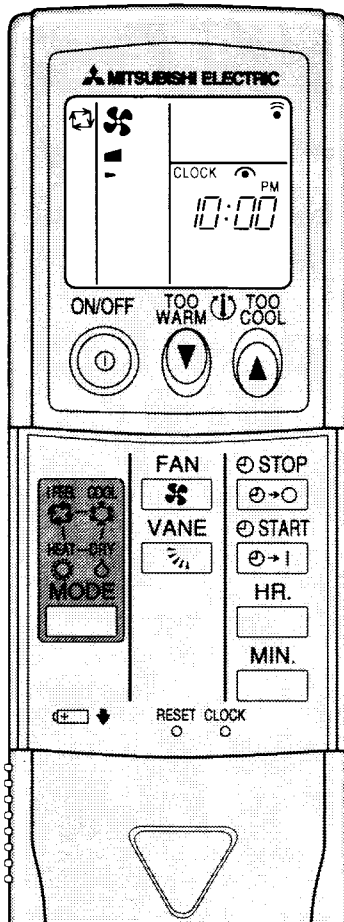

To change the AIR FLOW velocity, press the **FAN** button.

Each time the button is pressed, the fan speed is changed in sequence: **Lo** → **Med** → **Hi** → **(AUTO)**

- Use the **Hi** notch to cool/heat the room more.
- If the operating sound of the air conditioner disturbs your sleep, use the **Lo** notch.

To change the AIR FLOW blowing direction vertically, press the **VANE** button.

Each time the button is pressed, the angle of the horizontal vane is changed in sequence: **(1)** → **(2)** → **(3)** → **(4)** → **(5)** → **(SWING)** → **(AUTO)**

SWING OPERATION
Use the swing operation for the air flow to reach all corners of the room.

Recommended horizontal vane range

Use the **(AUTO)** position usually.
Use position **(1)** or **(2)** in the **COOL** or **DRY** mode and use positions **(3)** to **(5)** in the **HEAT** mode when adjusting to your requirements.

- NOTE**
- In the cooling operation, when the air conditioner is operated with setting the horizontal vane to **(4)** or **(5)** for 1 hour, the AIR FLOW direction is automatically set to horizontal to prevent condensed water from dropping.
 - Adjust the vertical AIR FLOW direction using the remote controller. If the horizontal vane is moved manually, it may cause trouble.
 - In the heating operation, if the air flow temperature is too low or when defrosting is being done, the horizontal vane position is set to **(1)**.

Auto air flow direction control operation

When the **AUTO** mode is selected with the **VANE** button, the position of the horizontal vane is automatically set to correspond to the operation mode for effective operation.

(1) HEAT
When the air flow temperature is too low, the air is blown out horizontally.

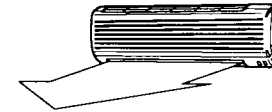

When the air flow temperature rises, the air is blown out downwards.

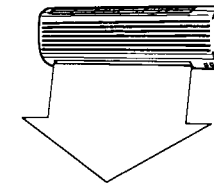

(2) COOL, DRY
The air is blown out horizontally.

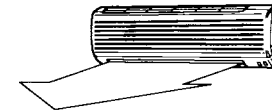

To change the horizontal direction of the air flow, move the vertical vane manually.

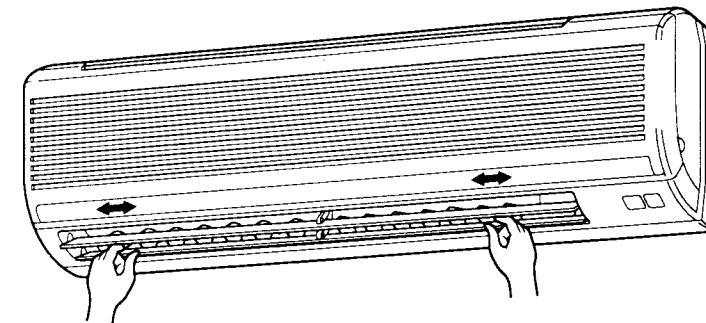

Adjust the vane before operation starts.
Since the horizontal vane moves automatically, your fingers may be caught.



TIMER OPERATION (ON/OFF TIMER)

TIMER

It is convenient to set the timer when you go to bed, when you get home, when you get up, etc.

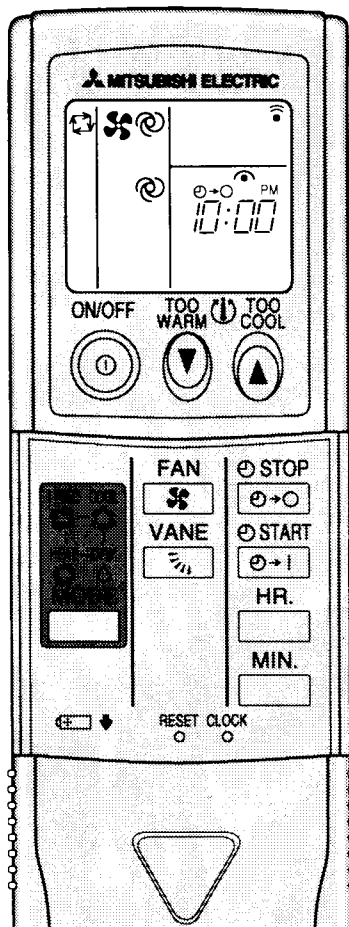

How to set the ON Timer

- 1 Press the **START** button during operation.
Each time the button is pressed, the ON timer mode alternates between ON and OFF.
- 2 Set the time of the timer using the **HR** and **MIN** buttons.
Each time the **HR** button is pressed, the set time increases by 1 hour; each time the **MIN** button is pressed, the set time increases by 10 minutes.

To release the ON timer:

- Press the **START** button.

How to set the OFF timer

- 1 Press the **STOP** button during operation.
Each time the button is pressed, the OFF timer mode alternates between ON and OFF.
- 2 Set the time of the timer using the **HR** and **MIN** buttons.
Each time the **HR** button is pressed, the set time increases by 1 hour; each time the **MIN** button is pressed, the set time increases by 10 minutes.

To release the OFF timer:

- Press the **STOP** button.

Programming timer operation

The ON timer and the OFF timer can be used in combination. The timer of the set time that is reached first will operate first. ("↑" mark indicates the order of timer operations.)

- If the current time has not been set, the timer operation cannot be used.

NOTE

If the main power is turned off or a power failure occurs while AUTO START/STOP timer is active, the timer setting is cancelled. As these models are equipped with the auto restart function, the air conditioner should start operating at the same time that a power has restored.

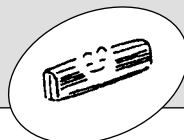

WHEN THE AIR CONDITIONER IS NOT GOING TO BE USED FOR A LONG TIME

When it is not going to be used for a long time:

- 1 Perform the FAN operation for 3 or 4 hours to dry the inside of the air conditioner.

- To perform FAN operation, set to the highest temperature in the MANUAL COOL OPERATION mode. (Refer to page 8.)

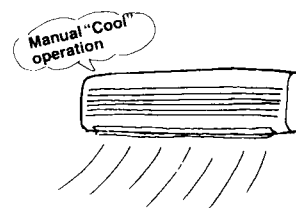

- 2 Turn off the breaker.

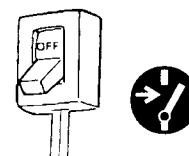

CAUTION

Turn off the breaker when the air conditioner is not going to be used for a long time. Dirt may collect and this may cause a fire.

- 3 Remove the batteries from the remote controller.

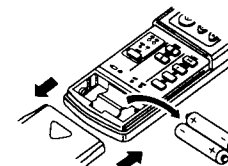

CAUTION

To prevent liquid leakage, take out all batteries when the remote controller is not going to be used for a long time.

When the air conditioner is to be used again:

- 1 Clean the air filter and install it in the indoor unit.

(Refer to page 11 for cleaning instructions.)

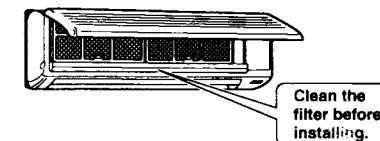

- 2 Check that the air inlet and outlet of the indoor/outdoor units are not blocked.

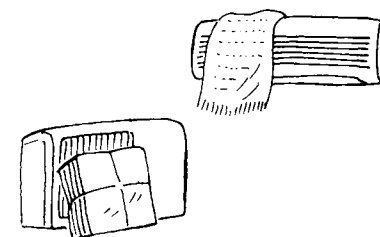

- 3 Check that the ground is connected correctly.

CAUTION

Ground the unit. Do not connect the ground to a gas pipe, water pipe, lightning rod or the ground of a telephone. If the grounding is incorrect, it may cause an electric shock.



MAINTENANCE

Before starting maintenance

Turn off the breaker.

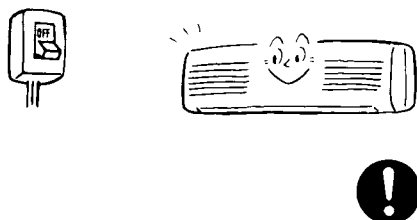

CAUTION

When the unit is to be cleaned, switch off and turn off the breaker.

Since the fan rotates at high speed during operation, it may cause an injury.

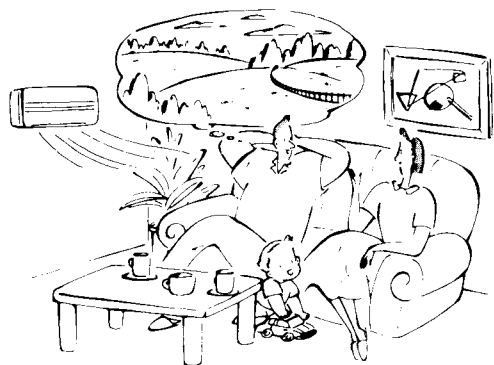

Cleaning the indoor unit

Clean using soft dry cloth.

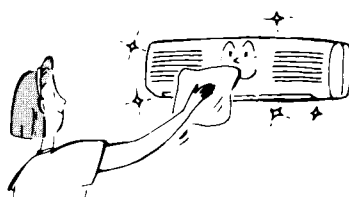

Do not use gasoline, benzine, polishing powder and detergent. And do not spray with insecticide. The unit may be damaged.



CLEANING THE AIR FILTER / DEODORIZING FILTER (OPTION)

Do not open the front panel up past the level position in order to prevent it from being damaged.

Cleaning the air filter (about once every 2 weeks)

1 Remove the air filter.

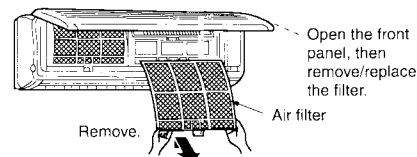

CAUTION

When the air filter is to be removed, do not touch the metal parts of the indoor unit. This may cause an injury.

2 Remove dirt from the air filter using a vacuum cleaner or by washing the filter with water.

- If dirt is conspicuous, wash the filter with a solution of detergent in lukewarm water.
- If hot water (120 °F or more) is used, the filter may be deformed.

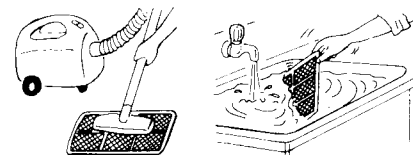

3 After washing with water/lukewarm water, dry the air filter well in the shade.

- Do not expose the air filter to direct sunlight or heat from a fire when drying it.

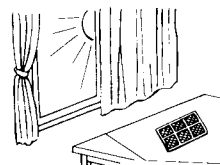

4 Install the air filter.

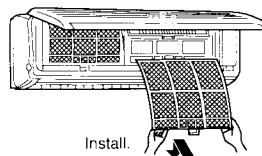

Cleaning the deodorizing filter (about once every 2 weeks)

1 Remove the air filter, and then remove the deodorizing filter (gray sponge type).

- The deodorizing filter is harmless to people. However, to keep its effectiveness, be sure to hold the frame and not to touch the surface of the filter with your hand.

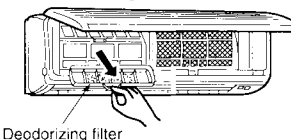

2 Soak the filter together with its frame in lukewarm water for about 15 minutes.

- If the dirt is conspicuous, use a solution of detergent in lukewarm water.
- If hot water (120 °F or more) is used, the filter may be deformed.
- Do not use a scrubbing brush or sponge. This may damage the surface of the filter.
- Do not use a chlorine detergent.



3 After washing with water/lukewarm water, dry the deodorizing filter well in the shade.

- Do not expose the deodorizing filter to direct sunlight or heat from a fire when drying it.

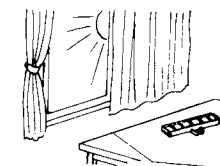

4 Install the deodorizing filter, and then install the air filter.

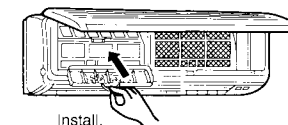





REPLACEMENT OF THE DEODORIZING FILTER (OPTION) / AIR CLEANING FILTER (OPTION)

When the capacity is lowered because of dirt, etc., it is necessary to replace the deodorizing filter/air cleaning filter.

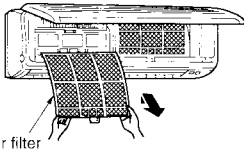
Deodorizing filter replacement (about once a year)

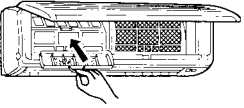
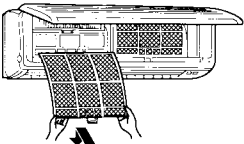
- 1 Remove the air filter.
 
- 2 Remove the deodorizing filter (gray sponge type).
 
- 3 Install a new deodorizing filter.
 
- 4 Install the air filter and securely close the front panel.
 

Deodorizing filter



- Cleaning is necessary about once every 2 weeks. However, if dirt is conspicuous, clean more often.
- When the color of the filter is not restored even if the filter is washed as the procedure shown on page 11 or when the filter becomes black, replace the filter with a new one.
- Standard interval for filter replacement is about 1 year.

Optional parts

Optional parts are available from your local dealer.

Model	MSH09TW	MSH12TN, MSH15TN, MSH17TN
Name of part		
DEODORIZING FILTER	MAC-1800DF	MAC-1600DF
AIR CLEANING FILTER	MAC-1300FT	MAC-1100FT

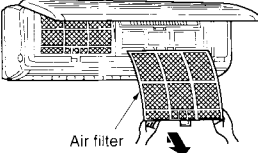
Air cleaning filter replacement (about once every 4 months)

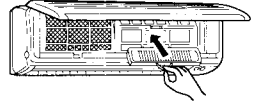
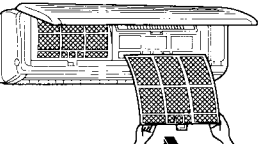
- 1 Remove the air filter.
 
- 2 Remove the air cleaning filter (white bellows type).
 
- 3 Install a new air cleaning filter.
 
- 4 Install the air filter and securely close the front panel.
 

Air cleaning filter

- If the air cleaning filter is clogged, it may lower the unit's capacity or cause condensation at the air outlet.
- The air cleaning filter is disposable. The standard usable interval is about 4 months. However, if the color of the filter turns to dark brown, replace the filter at once.

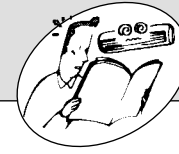

BEFORE CONTACTING THE SERVICEMAN, CHECK THE FOLLOWING AGAIN

The air conditioner cannot be operated.

Check the following.

- 1 The breaker is turned on and fuse is not blown.



- 2 The ON-timer is not set.



Cannot be cooled or heated sufficiently.

Check the following.

- 1 The temperature setting is correct.



- 2 Air filter is not dirty.

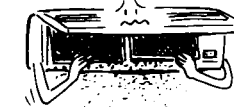

- 3 Outlet of the outdoor unit is not blocked.

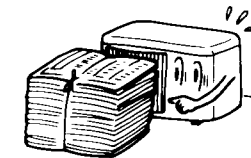

Display of the remote controller does not appear. The remote control signal cannot be received if it is not near the air conditioner.

- 1 The batteries are exhausted.



- 2 The polarity (+, -) of the batteries is confused.



When a power failure occurs. Check the following after the restoration of the power.

If the air conditioner had operated before the power failure, as these models are equipped with the auto restart function, the air conditioner should start operating again. (Refer to Description of "AUTO RESTART FUNCTION" on page 7.)

- 1 Does the air conditioner start operating again?







Even if the above items are checked, when the air conditioner does not recover from the trouble, stop using the air conditioner and consult your dealer.

In the following cases, stop operation and consult your dealer.

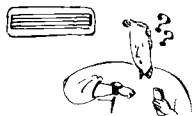
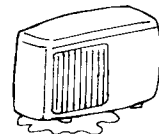
- The remote control signal may not be received in a room with an electronic ON/OFF type fluorescent lamp (inverter type fluorescent lamp, etc.) is used.
- In a weak radio wave area, when the air conditioner is operated, noise may be generated in radio reception.
- When thunder is heard, stop operation and turn off the breaker. Otherwise, the electrical parts may be damaged.

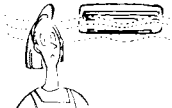
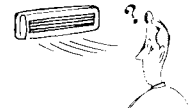
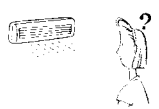
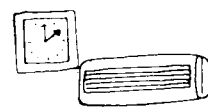

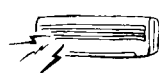
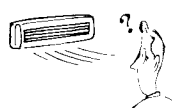
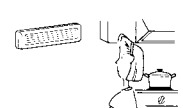
WHEN YOU THINK THAT TROUBLE HAS OCCURRED

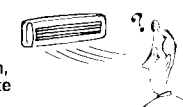
Question	Answer (not a malfunction)	Question	Answer (not a malfunction)
<p>The air conditioner cannot be operated for about 3 minutes when restarted.</p> 	<ul style="list-style-type: none"> This protects the air conditioner according to instructions from the microprocessor. Please wait. 	<p>Water leak from the outdoor unit.</p> 	<ul style="list-style-type: none"> During COOL and DRY operations, pipe or pipe connecting sections are cooled and this causes water to condense. In the heating operation, the defrosting operation makes water frozen on the outdoor unit melt and drip down. In the heating operation, water condensed on the heat exchanger drips down.
<p>Cracking sound is heard.</p> 	<ul style="list-style-type: none"> This sound is generated by the expansion/contraction of the front panel, etc. due to change in temperature. 	<p>The sound as burbling is heard.</p> 	<ul style="list-style-type: none"> This sound is heard when the outside air is absorbed from the drain hose in turning on the range hood or the ventilation fan and that makes water flowing in the drain hose spout out. This sound is also heard when the outside air blows into the drain hose in case the outside wind is strong.
<p>The room smells strange.</p> 	<ul style="list-style-type: none"> The air conditioner sucks in an odor adhering to the wall, carpet, furniture, cloth, etc. and blows it out with the air. 	<p>Air does not blow out soon in the heating operation.</p> 	<ul style="list-style-type: none"> Please wait as the air conditioner is preparing to blow out warm air.
<p>The fan stops during the DRY operation.</p> 	<ul style="list-style-type: none"> In DRY operation, the unit operates using the same refrigerant circuit as in COOL operation. DRY operation time has to be reduced in order to lower humidity without much room temperature decreasing. So the compressor sometimes stops, and at the same time the indoor fan stops. This prevents water condensed on the heat exchanger from evaporating again. 	<p>The operation is stopped for about 10 minutes in the heating operation.</p> 	<ul style="list-style-type: none"> Defrosting of the outdoor unit is being done (Defrosting operation). Since this is completed in 10 minutes, please wait. (When the external temperature is too low and humidity is too high, frost is formed.)
<p>The sound of water flowing is heard.</p> 	<ul style="list-style-type: none"> This is the sound of refrigerant flowing inside the air conditioner. This is the sound of condensed water flowing in the heat exchanger. This is the sound of the heat exchanger defrosting. 	<p>Hissing sound is sometimes heard.</p> 	<ul style="list-style-type: none"> This is the sound when the flow of refrigerant inside the air conditioner is switched.
<p>The air flow direction changes during operation.</p> 	<ul style="list-style-type: none"> When the air conditioner is operated in COOL or DRY mode, if the operation continues with air blowing down for 1 hour, the direction of the air flow is automatically set to horizontal to prevent condensed water from dropping. In the heating operation, if the air flow temperature is too low or when defrosting is being done, the horizontal vane position is automatically set to horizontal. 	<p>The room cannot be cooled sufficiently.</p> 	<ul style="list-style-type: none"> When a ventilation fan or a gas cooker is used in a room, the cooling load increases, resulting in an insufficient cooling effect. When the outside air temperature is high, the cooling effect may not be sufficient.
<p>Mechanical sound is heard from the indoor unit.</p> 	<ul style="list-style-type: none"> This is the switching sound in turning on/off the fan or the compressor. 	<p>The air conditioner starts the operation only with the main power turned on, though you do not operate the unit with the remote controller.</p> 	<ul style="list-style-type: none"> These models are equipped with the auto restart function. When the main power is turned off without stopping the air conditioner with the remote controller and is turned on again, the air conditioner will start operation automatically in the same mode as the one set with the remote controller just before the shutoff of the main power.



INSTALLATION, RELOCATION AND INSPECTION

Installation place

Avoid installing the air conditioner in the following places.

- Where flammable gas could leak.

⚠ CAUTION

Do not install the unit where flammable gas could leak.

If gas leak and collect around the unit, it may cause an explosion.

- Where there is much machine oil.
- Salty place such as the seaside.
- Where sulfide gas is generated such as a hot spring.
- Where oil is splashed or is filled with oily smoke.

Electrical work

- Provide an exclusive circuit for power supply of the air conditioner.
- Use the correct power (voltage and frequency) indicated on the unit to operate the air conditioner and use only fuses or breakers with specified capacity. Do not use pieces of wire instead of fuses.

⚠ WARNING

- The customer should not install this unit. If this is done incorrectly, it may cause a fire, electric shock, injury by dropping of the unit, water leakage, etc.
- Unit should be installed by licensed contractor according to local code requirements.

⚠ CAUTION

- Ground the unit. Do not connect the ground to a gas pipe, water pipe, lightning rod or the ground of a telephone. If a grounding is incorrect, it may cause an electric shock.
- If the air conditioner is installed in a high humidity area or near a water source, a Ground Fault Interrupt (GFI) circuit breaker should be installed to protect against shock.

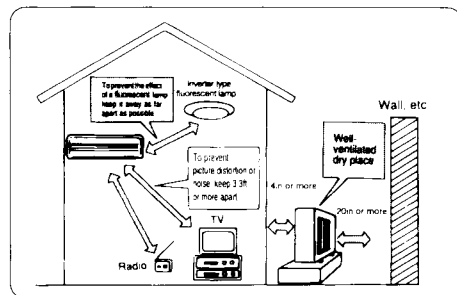

Inspection and maintenance

- When the air conditioner is used for several seasons, the capacity may be lowered due to dirt inside the unit.
- Depending on the use condition, an odor may be generated or dehumidified water may not drain out smoothly due to dirt, dust, etc.
- It is recommended to apply inspection and maintenance (charged) by a specialist in addition to normal maintenance. Consult your dealer.

Also consider operation sound

- Do not put an object around the air outlet of the outdoor unit. It may cause lowering of capacity or increase operation sound.
- If abnormal sound is heard during operation, consult your dealer.

Relocation

- When the air conditioner is to be removed or re-installed because of rebuilding, moving, etc., special techniques and work are required.

⚠ WARNING

Repair or relocation should not be done by the customer. If this is done incorrectly, it may cause a fire, electric shock, injury by dropping of the unit, water leakage, etc. Consult your dealer.

Disposal

To dispose of this product, consult your dealer.

If you have any questions, consult your dealer.

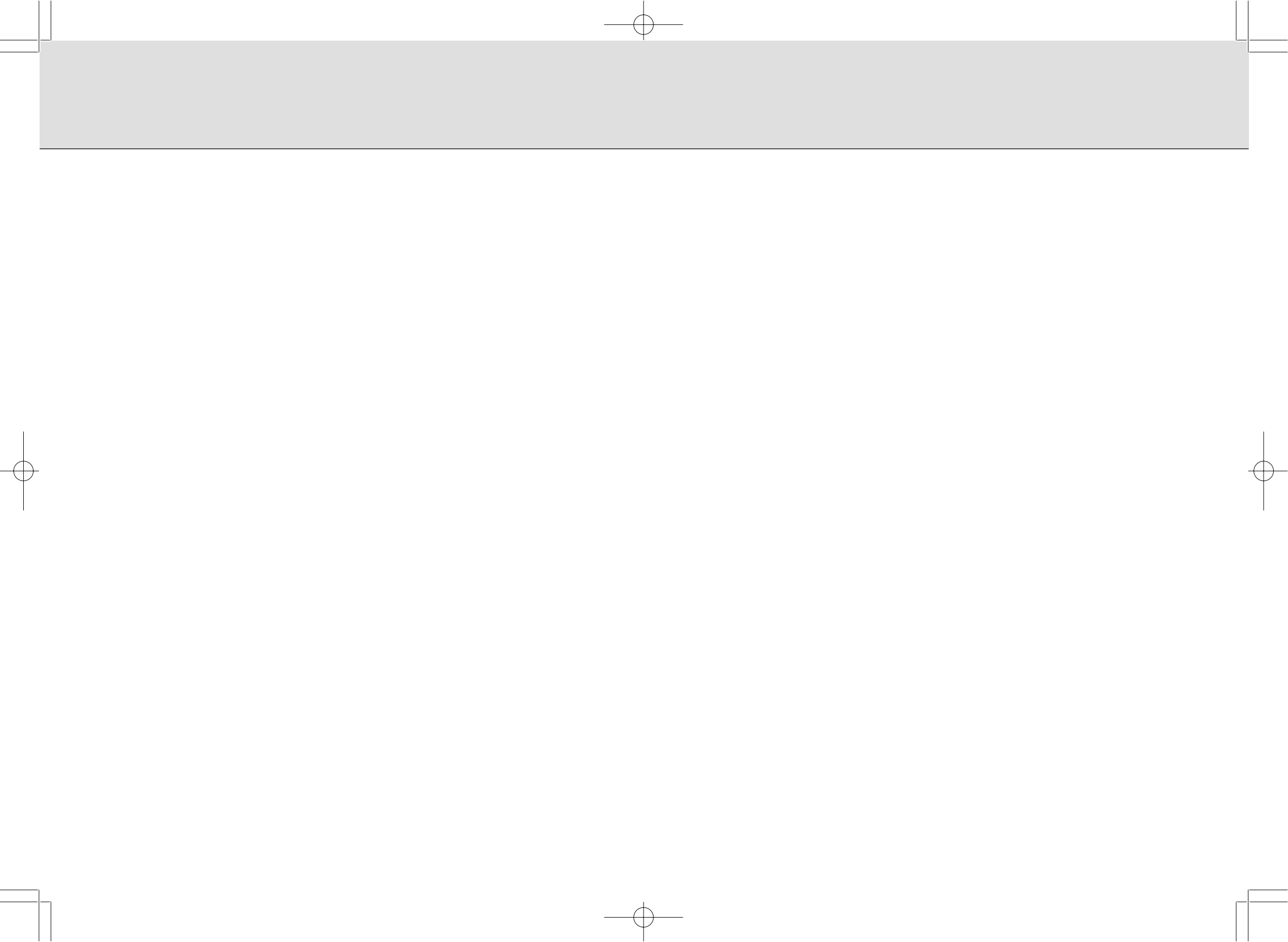



 **mitsubishi electric corporation**
HEAD OFFICE MITSUBISHI DENKI BLDG. MARUNOUCHI TOKYO 100-8310 TELEX J24532 CABLE MELCO TOKYO

SG79A624H01

