



SPLIT-TYPE AIR CONDITIONERS
Models
MS12/15/17TN Series
MSH12/15TN
[FLARE CONNECTION TYPE]

INSTALLATION MANUAL

1. THE FOLLOWING SHOULD ALWAYS BE OBSERVED FOR SAFETY

- Please report to your supply authority or obtain their consent before connecting this equipment to the power supply system.
- Be sure to read "THE FOLLOWING SHOULD ALWAYS BE OBSERVED FOR SAFETY" before installing the air conditioner.
- Be sure to observe the cautions specified here as they include important items related to safety.
- The indications and meanings are as follows.

⚠ WARNING

Could lead to death, serious injury, etc.

⚠ CAUTION

Could lead to serious injury in particular environments when operated incorrectly.

- After reading this manual, be sure to keep it together with the OPERATING INSTRUCTIONS in a handy place on the customer's site.

⚠ WARNING

- Do not install the unit by yourself (customer). Incomplete installation could cause injury due to fire, electric shock, the unit falling or leakage of water. Consult the dealer from whom you purchased the unit or special installer.
- Install the unit securely in a place which can bear the weight of the unit. When installed in an insufficient strong place, the unit could fall causing injury.
- Use the indoor/outdoor unit connecting wire that meets the Standards to connect the indoor and outdoor units and fix the wire to the terminal block securely so that no external force is conveyed to the connecting section of the terminal block. Incomplete connection or fixing of the wire could result in a fire.
- Do not use intermediate connection of the power cord or the extension cord and do not connect many devices to one AC outlet. It could cause a fire or an electric shock due to defective contact, defective insulation, exceeding the permissible current, etc.
- Check that the refrigerant gas do not leak after installation has completed.
- Perform the installation securely referring to the installation manual. Incomplete installation could cause a personal injury due to fire, electric shock, the unit falling or leakage of water.
- Perform electrical work according to the installation manual and be sure to use an exclusive circuit. If the capacity of the power circuit is insufficient or there is incomplete electrical work, it could result in a fire or an electric shock.
- Attach the electrical cover to the indoor unit and the service panel to the outdoor unit securely. If the electrical cover in the indoor unit and/or the service panel in the outdoor unit are not attached securely, it could result in a fire or an electric shock due to dust, water, etc.
- Be sure to use the part provided or specified parts for the installation work. The use of defective parts could cause an injury due to a fire, an electric shock, the unit falling, leakage of water, etc.
- Be sure to cut off the main power in case of setting up the indoor electronic control P.C. board or wiring works. It could cause an electric shock.

⚠ CAUTION

- Ground the unit. Do not connect the ground to a gas pipe, water pipe, lightning rod or telephone ground. Defective grounding could cause an electric shock.
- Do not install the unit in a place where an inflammable gas leaks. If gas leak and accumulate in the area surrounding the unit, it could cause an explosion.
- Install a ground leakage breaker depending on the installation place (Where it is humid). If a ground leakage breaker is not installed, it could cause an electric shock.
- Perform the drainage/piping work securely according to the installation manual. If there is a defect in the drainage/piping work, water could drop from the unit and household goods could be wet and damaged.

2. SELECTING THE INSTALLATION LOCATION

2-1 INDOOR UNIT

- Where airflow is not blocked.
- Where cool air spreads over the entire room.
- Maximum refrigerant piping length between indoor unit and outdoor unit is 49 ft. and the difference of height of both units is 25 ft. maximum.
- Rigid wall without vibration.
- Where it is not exposed to direct sunshine.
- Where easily drained.
- At a distance 3 ft. or more away from your TV and radio (to prevent picture from being distorted or noise from being generated).
- In a place as far away as possible from fluorescent and incandescent lights (so the infrared remote control can operate the air conditioner normally).
- Where the air filter can be removed and replaced easily.

2-2 OUTDOOR UNIT

- Where it is not exposed to strong wind.
- Where airflow is good and dustless.
- Where it is not exposed to rain and direct sunshine.
- Where neighbours are not annoyed by operation sound or hot air.
- Where rigid wall or support is available to prevent the increase of operation sound or vibration.
- Where there is no risk of combustible gas leakage.
- When installing the unit at a high level, be sure to fix the unit legs.
- Where it is at least 10 ft. away from the antenna of TV set or radio. (Otherwise, images would be disturbed or noise would be generated.)
- Install the unit horizontally.

⚠ CAUTION

- Avoid the following places for installation where air conditioner trouble is liable to occur.
- Where there is too much machine oil.
 - Salty environment as seaside areas.
 - Hot-spring areas.
 - Where sulfide gas exists.
 - Other special atmospheric areas.

2-3 WIRELESS REMOTE CONTROLLER MOUNTING

- Place of mounting
 - Where it is easy to operate and easily visible.
 - Where children can not touch.
- Mounting

Select a position about 4 ft. above the floor, check that signals from the remote controller are surely received by the indoor unit from that position ('beep' or 'beep-beep' receiving tone sounds). After that, attach remote controller mounting hardware ① to a pillar or wall and set the wireless remote controller ②.

In rooms where inverter type fluorescent lamps are used, the signal from the wireless remote controller may not be received.

3. INSTALLATION DIAGRAM & ACCESSORIES

FLARED CONNECTIONS

- This unit has flared connections on both indoor and outdoor sides.
- Remove the valve cover of the outdoor unit, then connect the pipe.
- Refrigerant pipes are used to connect the indoor and outdoor units.

Limits	
Pipe length	49 ft. max.
Height difference	25 ft. max.
No. of bends	10 max.

- Refrigerant adjustment ... If pipe length exceeds 25 ft., additional refrigerant (R-22) charge is required.
(The outdoor unit is charged with refrigerant for pipe length up to 25 ft..)

Pipe length	Limits	
	Up to 25 ft.	No additional charge is required.
Exceeding 25 ft.	Additional charge is required. (Refer to the table below.)	
Refrigerant to be added	MS type	0.53 oz each 5 ft.
	MSH type	2.68 oz each 5 ft.

ACCESSORIES

Check the following parts before installation.

1	Installation plate	1
2	Installation plate fixing screw 4 × 25 mm	6
3	Remote controller mounting hardware	1
4	Fixing screw for 3.5 × 16 mm (Black)	2
5	Battery (AAA) for remote controller	2
6	Wireless remote controller	1
7	Felt tape (Used for left or left-rear piping)	1

PART TO BE PROVIDED AT YOUR SITE

Optional extension pipe

A	Indoor/outdoor unit connecting wire	1
B	Extension pipe	1
C	Wall hole sleeve	1
D	Wall hole cover	1
E	Pipe fixing band (The quantity depends on the pipe length.)	2 to 5
F	Fixing screw for 4 × 20 mm (The quantity depends on the pipe length.)	2 to 5
G	Piping tape	1
H	Putty	1
I	Drain hose (or soft PVC hose, 19/32 in. inner dia. or hard PVC pipe VP16)	1
J	Refrigeration oil	1

PIPING PREPARATION

- Table below shows the specifications of pipes commercially available.
- Ensure that the 2 refrigerant pipes are insulated to prevent condensation.
- Refrigerant pipe bending radius must be 4 in. or more.

Pipe	Outside diameter	Minimum wall thickness	Insulation thickness	Insulation material	
	inch		inch		
For liquid	1/4	0.0265	5/16	Heat resisting foam plastic Specific gravity 0.045	
For gas	12 type	1/2	0.0285		5/16
	15, 17 type	5/8	0.0315		5/16

- Minimum wall thickness is UL1995 33's reference.
- Refrigerant pipes of 10, 16, 23, 33 and 49 ft. are available as optional items.

CAUTION

Be sure to use the insulation of specified thickness. Excessive thickness may cause incorrect installation of the indoor unit and lack of thickness may cause dew dripage.

Decide the installation position using mark on the installation plate indicating the indoor unit size as reference.

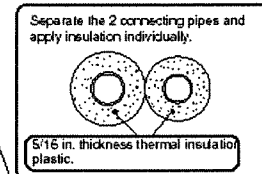
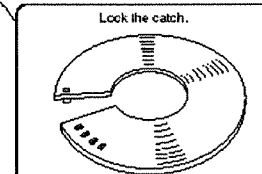
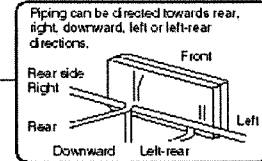
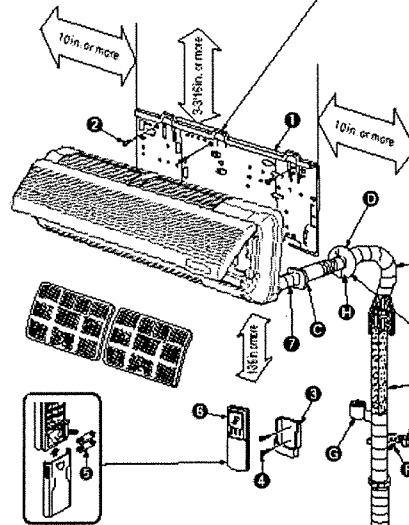
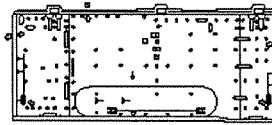

When the piping is to be attached to a wall containing metals (tin plated) or metal netting, use a chemically treated wooden piece 13/16 in. or thicker between the wall and the piping or wrap 7 to 8 turns of insulation vinyl tape around the piping.

MU12TN and MUH12TN

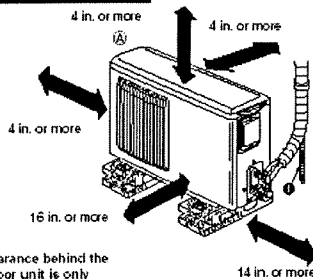

Note:
If clearance behind the outdoor unit is only 15-3/4 or 20 in., side (A) must be fully opened.

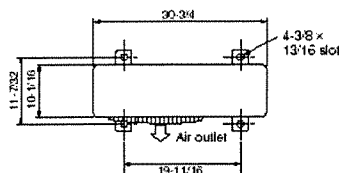

MU15/17TN and MUH15TN

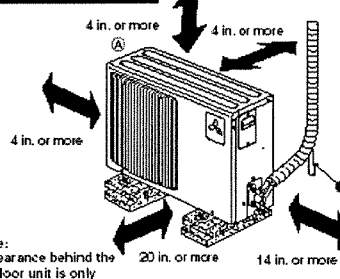

Note:
If clearance behind the outdoor unit is only 15-3/4 or 20 in., side (A) must be fully opened.

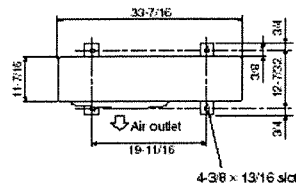

(Unit inch)

Units should be installed by licensed contractor according to local code requirement.

4. INDOOR UNIT INSTALLATION

4-1 FIXING OF INSTALLATION PLATE

- Find a structural material (such as a stud) in the wall and fix installation plate horizontally.

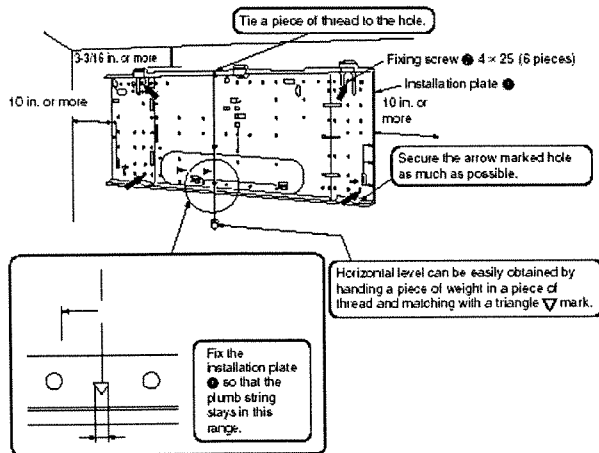

When bolts recessed in the concrete wall are to be utilized, secure the installation plate using 7/16 in. × 13/16 in. / 7/16 in. × 1 in. oval hole (17-3/4 in. mm pitch). If the recessed bolt is too long, change it for a shorter one available in the market.

4-2 WALL HOLE DRILLING

- Determine the wall hole position.
- Drill a 3 in. hole so that outside can be lower than inside.
- Insert the wall hole sleeve.

Positioning of the holes on the wall

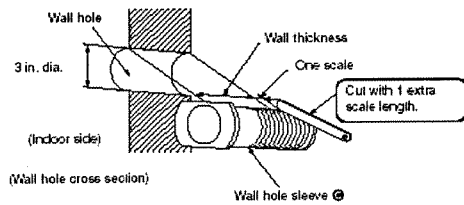
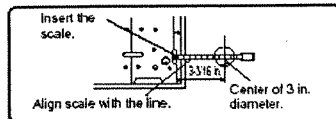
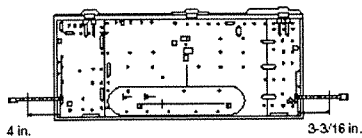

Be sure to use wall hole sleeve to prevent the outdoor connecting wires from contacting with metal part in the wall and to prevent damage by rat in case the wall is hollow.

Wall hole sealing and fixing pipe to wall

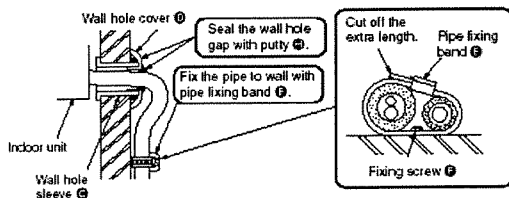

4-3 POWER SUPPLY AND INDOOR/OUTDOOR CONNECTING WIRE CONNECTION

- Power should be taken from an exclusive branched circuit.
- Wiring work should be based on applicable technical standards.
- Wiring connections should be made following the diagram. Screws should be tightened so they won't loosen.

ELECTRICAL SPECIFICATIONS			
MODEL	MS12TN	MS15TN	MS17TN
INDOOR UNIT			
Power supply (V, PHASE, Hz)	115, 1, 60	115, 1, 60	115, 1, 60
Min. Circuit Ampacity	0.6	0.6	0.7
Fan motor (F.L.A)	0.43	0.43	0.51
OUTDOOR UNIT			
Power supply (V, PHASE, Hz)	208/230, 1, 60	208/230, 1, 60	208/230, 1, 60
Max. Fuse size (time delay) (A)	15	20	20
Min. Circuit Ampacity	12	14	15
Fan motor (F.L.A)	0.42	0.52	0.52
Compressor	(R.L.A)	9.0	10.0
	(L.R.A)	29.0	35.0
Control voltage	Indoor unit-Remote controller: (Wireless) Indoor unit-Outdoor unit: DC12V (Polar)		

ELECTRICAL SPECIFICATIONS		
MODEL	MSH12TN	MSH15TN
INDOOR UNIT		
Power supply (V, PHASE, Hz)	115, 1, 60	115, 1, 60
Min. Circuit Ampacity	0.6	0.6
Fan motor (F.L.A)	0.43	0.43
OUTDOOR UNIT		
Power supply (V, PHASE, Hz)	208/230, 1, 60	208/230, 1, 60
Max. Fuse size (time delay) (A)	15	20
Min. Circuit Ampacity	14	14
Fan motor (F.L.A)	0.42	0.52
Compressor	(R.L.A)	10.0
	(L.R.A)	35.0
Control voltage	Indoor unit-Remote controller: (Wireless) Indoor unit-Outdoor unit: DC12V (Polar)	

Note:

If the indoor unit is powered from outdoor unit, a separate circuit breaker is not required but a disconnect switch may be required by local code. If the indoor unit is powered from an independent power supply, a dedicated circuit breaker or maximum fuse size of 15 A must be installed for the indoor unit, and a disconnect switch may also be required. (Refer to the figures on the right.)

- Remove the front panel (Refer to 7-1)
- Remove the electrical cover
- Remove the display panel

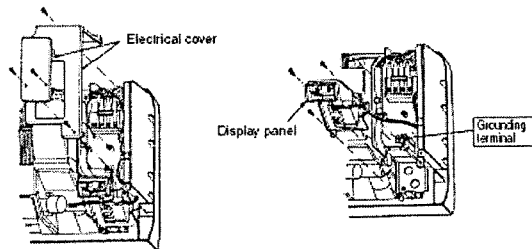

- Fix the conduit connector to conduit cover with lock nut, then secure it against electrical box with screws.

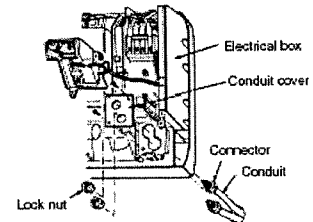

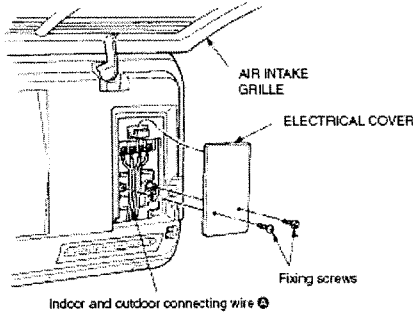

WARNING

- Use the indoor/outdoor unit connecting wire that meets the Standards to connect the indoor and outdoor units and fix the wire to the terminal block securely so that no external force is conveyed to the connecting section of the terminal block. Incomplete connection or fixing of the wire could result in a fire.
- Attach the electrical cover securely. If it is attached in correctly, it could result in a fire or an electric shock due to dust, water, etc.

Connect wires to the matching numbers of terminals.

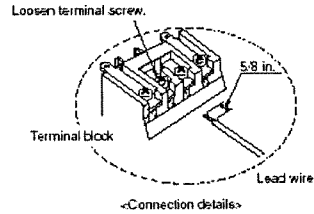

MS12H17TN

Remark:

- Indoor unit can also be powered from an independent power supply (Max. Fuse size (time delay): 15 A). In this case these indoor/outdoor connecting wires for indoor power supply are not necessary.

-- A disconnect switch may be required. Check the local code.

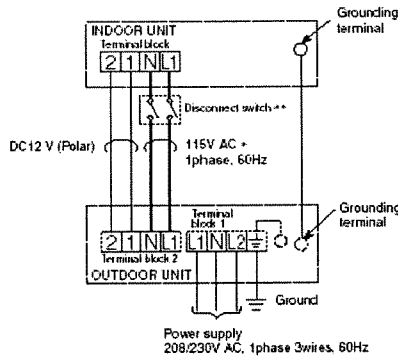

MSH2H15TN

Remark:

- Indoor unit can also be powered from an independent power supply (Max. Fuse size (time delay): 15 A). In this case these indoor/outdoor connecting wires for indoor power supply are not necessary.

-- A disconnect switch may be required. Check the local code.

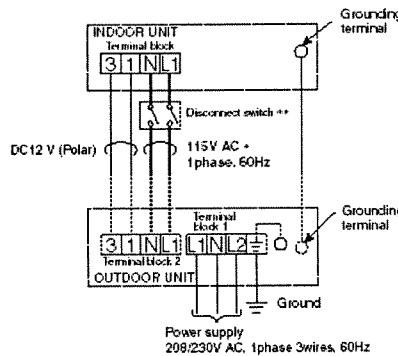

CONNECTING WIRES

- Wire to be AWG22 double insulated, 300 V insulation. Equal to Belden 9407 (for 12 V DC).
- Use copper conductors only.

CAUTION

- Be careful not to make mis-wiring.
- Firmly tighten the terminal screws to prevent them from loosening.
- After tightening, pull the wires lightly to confirm that they do not move.
- If the connecting wire is incorrectly connected to the terminal block, the unit does not operate normally.
- If a ground is incorrect, it may cause an electric shock.

4-4 AUTO RESTART FUNCTION

- When the units of these models are shipped from the factory, auto restart function is set to ON. If you want to know how to release this function, consult the service center.
- When the indoor unit is controlled with the remote controller, the operation mode, the set temperature, and the fan speed are memorized by the indoor electronic control P.C. board. The auto restart function sets to work the moment the power has restored after power failure, then, the unit will restart automatically. If the unit is operated in "I FEEL CONTROL" mode before power failure, the operation is not memorized. In "I FEEL CONTROL" mode, the operation is decided by the initial room temperature at (re)start.

Operation

- If the power of the indoor unit (115V AC) has been cut, the operation settings remain.

Remark:

When indoor and outdoor unit are powered in separate circuit even if the power of the outdoor unit (208/230V AC) is cut auto restart function doesn't work.

- When three minutes have passed after power was restored, the unit will restart automatically according to the memory.

Notes:

- The operation settings are memorized when 10 seconds have passed after the remote controller was operated.
- If the main power is turned off or a power failure occurs while AUTO START/STOP timer is active, the timer setting is cancelled. As these models are equipped with the auto restart function, the air conditioner should start operating at the same time that a power has restored.
- If the unit has been off with the remote controller before power failure, the auto restart function does not work as the power button of the remote controller is off.
- To prevent breaker off due to the rush of starting current, systematize other home appliances not to turn on at the same time.

4-5 PIPE FORMING

- Place the drain hose below the refrigerant piping.
- Make sure that the drain hose is not heaved or snaked.
- Do not pull the hose to apply the tape.
- When the drain hose passes the room, be sure to wrap insulation material (obtainable at a store) around it.
- Wrap the felt tape around the pipe and the drain hose, then put the pipe in the back space of the indoor unit.

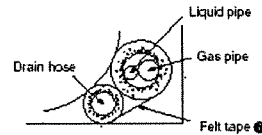

FOR REAR, RIGHT OR DOWNWARD PIPING

- Pipe arrangement**
Put the refrigerant piping and the drain hose together, then apply piping tape to them.

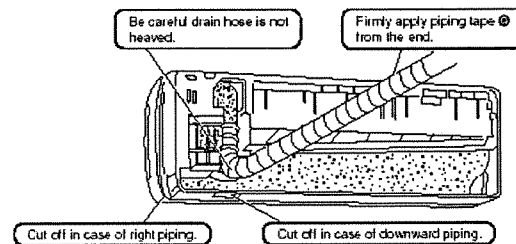

- Insert the piping and the drain hose into the wall hole sleeve, and hook the upper part of the indoor unit on the installation plate.
- Check if the indoor unit is hooked securely on the installation plate by moving the unit to left and right.
- Thrust the lower part of the indoor unit into the installation plate.

FOR LEFT OR LEFT-REAR PIPING

- Pipe arrangement
Put the refrigerant piping and the drain hose together, then apply felt tape ① to them.

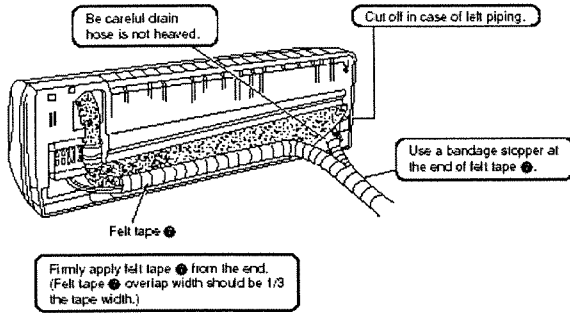

REATTACHING DRAIN HOSE

Be sure to reattach the drain hose and the drain cap in case of left or left-rear piping. Otherwise, it could cause drops of water to drip down from the drain hose.

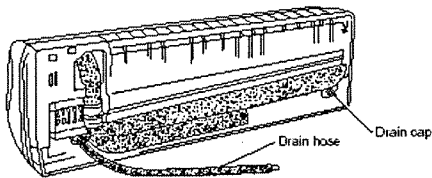

① Pull out the drain cap at the rear right of the indoor unit.

Hold the convex section at the end and pull the drain cap.

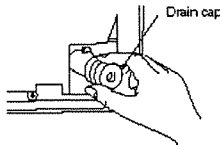

② Pull out the drain hose at the rear left of the indoor unit.

Hold the claw marked by the arrow and pull out the drain hose forward.

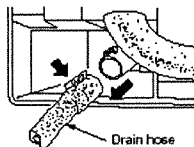

③ Put the drain cap into the section to which the drain hose is to be attached at the rear of the indoor unit.

Insert the screwdriver, etc. (not sharp-edged tool) into the hole at the end of the cap and insert the cap fully into the drain pan.

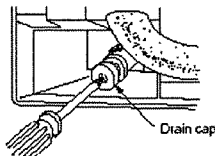

④ Insert the drain hose into the section to which the drain hose is to be attached at the rear right of the indoor unit.

Insert the drain hose fully into the drain pan. Check if the hose is hooked securely to the projection of its inserting part at the drain pan.

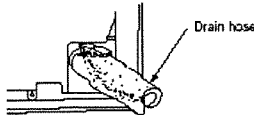

INDOOR UNIT INSTALLATION

- Insert the drain hose into the wall hole sleeve ②, and hook the upper part of indoor unit on the installation plate ①. Then, move the unit to the very edge of the left side for putting the piping easily in the back space of the indoor unit.

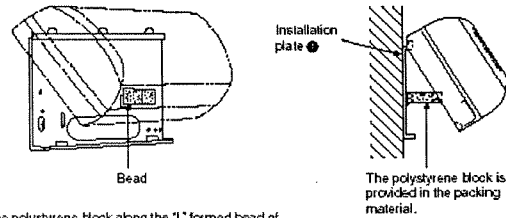

Set the polystyrene block along the "L" formed bead of the installation plate to hold the unit obliquely.

- Connect the refrigerant piping with the extension pipe ③.
- Thrust the lower part of the indoor unit into the installation plate ①.

4-6 DRAIN PIPING

- The drain hose should point downward for easy drain flow. (Fig. 1)
Do not make drain piping as shown in Fig. 2 to 5.

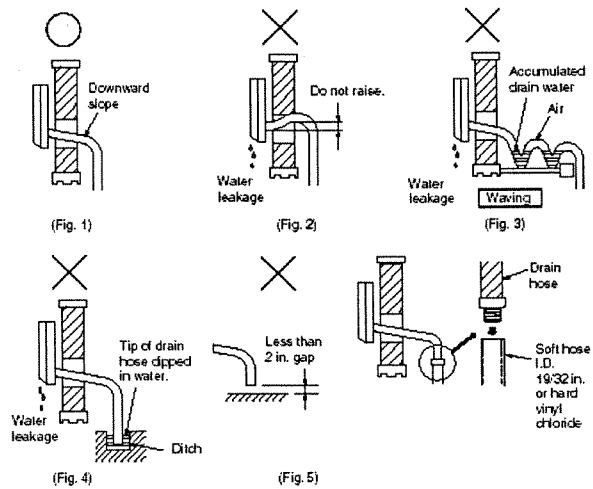

- If the drain hose provided with the indoor unit is too short, connect it with drain hose ① that should be provided at your site.
- If the extension drain hose has to pass through a room, be sure to wrap it with commercially sold insulation.

5. OUTDOOR UNIT INSTALLATION

5-1 POWER SUPPLY AND INDOOR AND OUTDOOR WIRE CONNECTION

- Connect the indoor/outdoor unit connecting wire ② from the indoor unit correctly on the terminal block.
- For future servicing, give extra length to connecting wire.

Connect wires to the matching numbers of terminals.

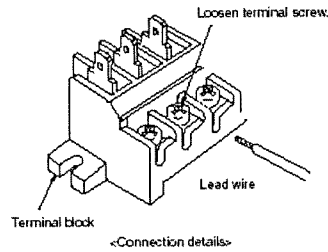

MU12H5A7TN

Remark:

- Indoor unit can also be powered from an independent power supply (Max. Fuse size (time delay) : 15 A). In this case these indoor/outdoor connecting wires for indoor power supply are not necessary.

→ A disconnect switch may be required. Check the local code.

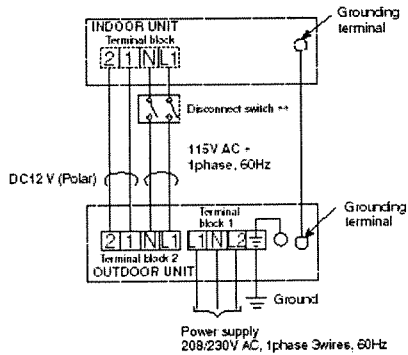

MUH2H5TN

Remark:

- Indoor unit can also be powered from an independent power supply (Max. Fuse size (time delay) : 15 A). In this case these indoor/outdoor connecting wires for indoor power supply are not necessary.

→ A disconnect switch may be required. Check the local code.

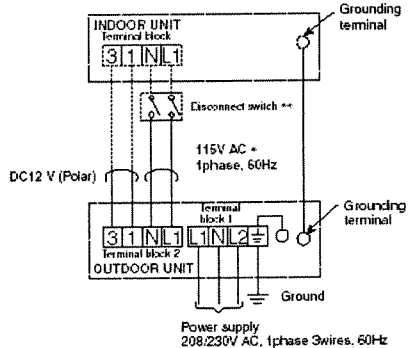

CONNECTING WIRES

- Wire to be AWG22 double insulated, 300 V insulation. Equal to Belden 9407 (for 12 V DC).
- Use copper conductors only.

CAUTION

- Be careful not to make mis-wiring.
- Firmly tighten the terminal screws to prevent them from loosening.
- After tightening, pull the wires lightly to confirm that they do not move.
- If the connecting wire is incorrectly connected to the terminal block, the unit does not operate normally.
- If a ground is incorrect, it may cause an electric shock.

5-2 GROUNDING

- Remove the service panel.
- Fix the conduit connector to conduit cover with lock nut then secure it against unit with screw.
- Leave some slack in wires to allow easier servicing.

MU12TN and MUH12TN

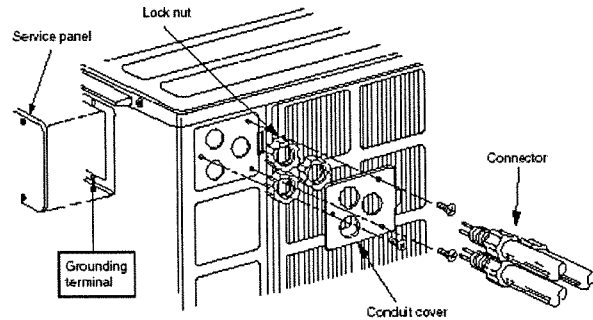

MUH5A7TN and MUH5TN

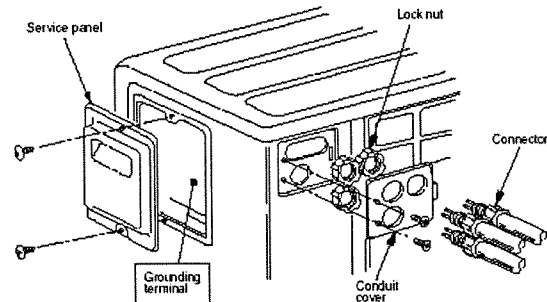

CAUTION

Use care so as connecting wires do not contact pipes.

WARNING

Be sure to attach the service panel of the outdoor unit securely. If it is not attached correctly, it could result in a fire or an electric shock due to dust, water, etc.

6. INDOOR/OUTDOOR UNIT CONNECTION FINISHING AND TEST RUN

6-1 FLARING WORK

- Main cause of gas leakage is defect in flaring work. Perform flaring work correctly in the following procedure.

① Pipe cutting

- Cut the copper pipe correctly with pipe cutter.

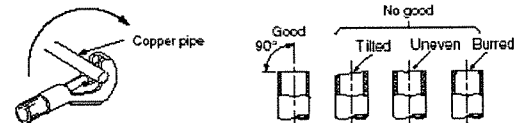

② Burrs removal

- Completely remove all burrs from the cut cross section of the pipe.
- Put the end of the copper pipe downward to prevent burrs from dropping in the pipe.

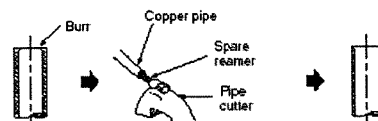

3 Putting nut on

- Remove flare nuts attached to indoor and outdoor units, then put them on pipe having completed burr removal. (not possible to put them on after flaring work)

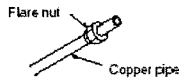

4 Flaring work

- Perform flaring work using flaring tool as shown below.

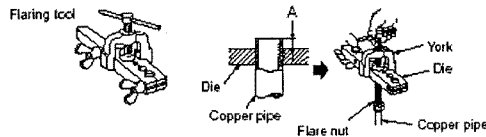

Outside diameter		A
mm	inch	inch
6.35	1/4	3/32
12.7	1/2	5/32
15.88	5/8	5/32

- Firmly hold copper pipe in a die in the dimension shown in the table above.

5 Check

- Compare the flared work with figure below.
- If flare is noted to be defective, cut off the flared section and perform flaring work again.

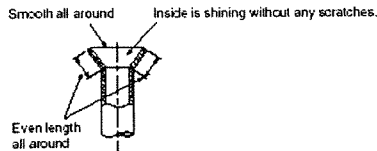

6-2 PIPE CONNECTION

① Indoor unit connection

Connect both liquid pipe and gas pipe to indoor unit.

- Apply a thin coat of refrigeration oil ① on the seat surface of pipe.
- For connection, align the center of both pipe and union, then tighten the first 3 to 4 turns in flare nut by hand.
- For tightening the union part of the indoor unit side, use the table below as a standard and tighten the flare nut using two wrenches. Excessive tightening damages the flare section.

Pipe diameter		Tightening torque
mm	inch	ft · lb
6.35	1/4	10 to 13
12.7	1/2	36 to 42
15.88	5/8	54 to 58

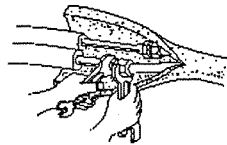

② Outdoor unit connection

Connect pipes to the pipe joint part of the stop valve in the same method as the indoor unit.

- For tightening, use the same tightening torque applied for indoor unit and tighten the flare nut with torque wrench or spanner.

INSULATION AND TAPING

- Cover piping joints with pipe cover.
- For outdoor unit side, surely insulate every piping including valves.
- Using piping tape ②, apply taping starting from the entry of outdoor unit.
- Fix the end of piping tape ② with adhesive tape.
- When piping has to be arranged through above ceiling, closet or area where the temperature and humidity are high, wind additional commercially sold insulation for prevention of condensation.

6-3 PURGING PROCEDURES-LEAK TEST

PURGING PROCEDURES

Connect the refrigerant pipes (both liquid pipe and gas pipe) between the indoor and the outdoor unit.

Remove the service port cap of the stop valve on the gas pipe side of the outdoor unit. (The stop valve will not work in its initial state fresh out of the factory (totally closed with cap on).)

Connect the gauge manifold valve and the vacuum pump to the service port of the stop valve on the gas pipe side of the outdoor unit.

Run the vacuum pump. (Vacuumize for more than 15 minutes.)

Check the vacuum with the gauge manifold valve, then close the gauge manifold valve and stop the vacuum pump.

Leave as it is for one or two minutes. Make sure the pointer gauge manifold valve remains in the same position. Confirm that the pressure gauge shows -0.101 MPa [Gauge] (-30 in. Hg).

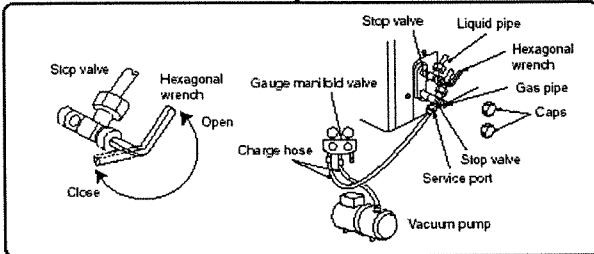

Remove the gauge manifold valve quickly from the service port of the stop valve.

After refrigerant pipes are connected and evacuated, fully open all stop valves on both sides of gas pipe and liquid pipe. Operating without fully opening lowers the performance and this causes trouble.

Pipe length up to 25 ft.
No gas charge is needed.

Pipe length exceeding 25 ft.
Charge the prescribed amount of gas. (refer to 3)

Tighten the cap to the service port to obtain the initial status.

Retighten the cap of the stop valve.

Leak test

	Tightening torque	
	ft · lb	
Cap for service port	10 to 13	
Cap for stop valve	15 to 22	

6-4 TEST RUN

MS type

- Before performing the test run, recheck any wrong wiring. Wrong wiring prevents normal operation or results in blown fuse disabling operation.
- The test run can be started by pressing EMERGENCY OPERATION switch. When the EMERGENCY OPERATION switch is once pressed, the unit will start the test run (continuous operation) for 30 minutes. A thermostat does not work during this time. After 30 minutes the unit will start the EMERGENCY OPERATION at a fixed temperature setting of 75 °F in COOL MODE.
- Perform test run in the following procedure.

PROCEDURE

- Press the EMERGENCY OPERATION switch.
- Press it once, and after test run for 30 minutes the EMERGENCY COOL MODE starts.
- Press it once more, and the operation stops. (The operation mode alternates between ① and ② every time the EMERGENCY OPERATION switch is pressed.)

Mode	Operation Indicator lamp	
① COOL	(Light)	(Off)
② STOP	(Off)	(Off)

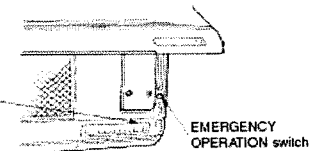

MSH type

- Before performing the test run, recheck any wrong wiring. Wrong wiring prevents normal operation or results in blown fuse disabling operation.
- The test run can be started by pressing EMERGENCY OPERATION switch. When the EMERGENCY OPERATION switch is once pressed, the unit will start the test run (continuous operation) for 30 minutes. A thermostat does not work during this time. After 30 minutes the unit will start the EMERGENCY OPERATION at a fixed temperature setting of 75 °F in COOL MODE or HEAT MODE.
- Perform test run in the following procedure.

PROCEDURE

- Press the EMERGENCY OPERATION switch.
- ① Press it once, and after test run for 30 minutes the EMERGENCY COOL MODE starts.

If the left side lamp of the operation indicator blinks every 0.5 seconds, inspect the indoor/outdoor connecting wire for mis-wiring.

- ② Press it once more, and the EMERGENCY HEAT MODE starts.
 - ③ Press it once more, and the operation stops.
- (The operation mode changes in order of ① ~ ③ every time the EMERGENCY OPERATION switch is pressed.)

Mode	Operation Indicator lamp	
① COOL	(Light)	(Off)
② HEAT	(Off)	(Light)
③ STOP	(Off)	(Off)

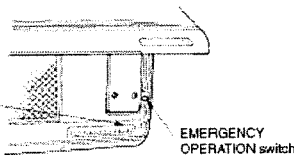

- In starting the heating operation, indoor unit fan may not operate to prevent blowing cool air. Please wait for a few minutes until the temperature of heat exchanger rises and warm air blows out.

MS type and MSH type

Checking the remote (infrared) signal reception

Press the ON/OFF button on the remote controller and check that an electronic sound is heard from the indoor unit. Press the ON/OFF button again to turn the air conditioner off.

Checking the auto restart function

After operating the unit with the remote controller, turn off the main power. Then turn it on again and check if the unit operates in the same mode as the mode right before the main power shut-off.

If the indoor unit is operated with the remote controller, both the test run and the emergency operation are released by commands from the remote controller.

- Once the compressor stops, the restart preventive device operates so the compressor will not operate for three minutes to protect the air conditioner.

6-5 EXPLANATION TO THE CUSTOMER

- Using the OPERATING INSTRUCTIONS, explain the following to the customer, how to control temperature, how to remove the air filters, how to remove or put the remote controller in the remote controller mounting hardware, how to clean, precautions for operation, etc.
- Recommend the customer to read the OPERATING INSTRUCTIONS carefully.

7. FOR MOVEMENT AND MAINTENANCE

7-1 REMOVING AND REINSTALLING THE FRONT PANEL

FRONT PANEL REMOVAL

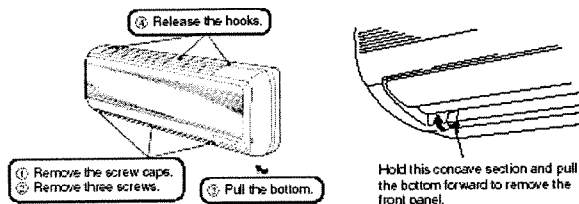

FRONT PANEL REINSTALLATION

- ① Before installing the panel, set the horizontal vane to the position as shown in the figure below.
- ② Attach the bottom of the panel under the horizontal vane.
- ③ Set the top of the panel.
- ④ Push as the arrow mark on the panel to fix it to the air conditioner.

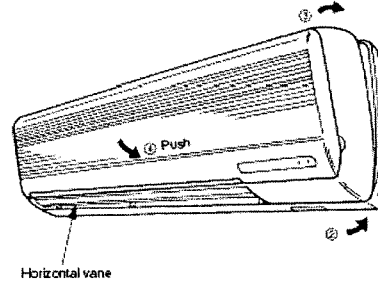
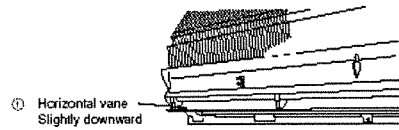

7-2 REMOVING THE INDOOR UNIT

Remove the bottom of the indoor unit from the installation plate.

- ① Remove the front panel. (See FRONT PANEL REMOVAL shown above.)
- ② Insert flat screwdrivers into the square holes at the left and right bottom of the indoor unit and push them up; the bottom of the indoor unit goes down and the hooks are released.

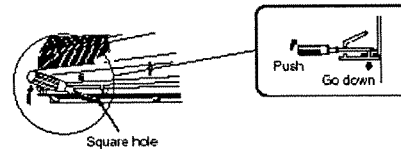

7-3 GAS CHARGE

- ① Connect gas cylinder to the service port of stop valve (3-way).
- ② Perform air purge of the pipe (or hose) coming from refrigerant gas cylinder.
- ③ Replenish specified amount of the refrigerant, while operating the air conditioner for cooling.

CAUTION

Never charge liquid refrigerant, such as by inverting the gas cylinder while charging, otherwise troubles may be generated.

To maintain the high pressure of the gas cylinder, warm the gas cylinder with warm water (under 105 °F) during cold season. But never use naked flame or steam.

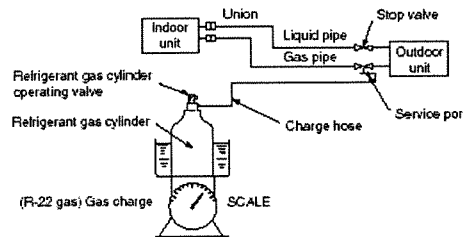

MITSUBISHI ELECTRIC CORPORATION
 HEAD OFFICE: MITSUBISHI DENKI BLDG., 2-2-3, MARUNOUCHI, CHIYODA-KU,
 TOKYO 100-8310, JAPAN