

MITSUBISHI ELECTRIC

Package Air-Conditioner

i-see Sensor

Wireless remote controller kit with i-see Sensor

Wireless remote controller kit

Installation Manual

PAC-SH91MK-E

PAR-SA92MW-E

PAR-SL93B-E

This manual describes the installation for i-see sensor, wireless remote controller kit with i-see sensor and wireless remote controller kit of the Mitsubishi ceiling suspended series package air-conditioner. Read this manual carefully.

1 Safety Precautions

- Read these "Safety Precautions" thoroughly and install securely.
- Precautions are classified using the following symbols depending on the extent and type of danger by erroneous handling.

⚠ WARNING	Erroneous handling can cause death or serious injury.
⚠ CAUTION	Erroneous handling can cause personal injury or damage.

- After using this manual, be sure to pass it to the customer together with the instruction manual provided with the indoor unit. Ask the customer to keep this installation manual and the instruction manual in a handy place, and to show them to the engineer when the air-conditioner is moved or repaired. Also ask the customer to pass them to any new user.

⚠ WARNING

<p>Ask a dealer or specialist to install the unit.</p> <ul style="list-style-type: none"> Incomplete installation could cause electric shock, fire, etc. 	<p>Securely install the unit, referring to this installation manual.</p> <ul style="list-style-type: none"> Incomplete installation could cause electric shock, fire, etc.
<p>Securely install the unit in a place that can withstand the weight.</p> <ul style="list-style-type: none"> Otherwise, the unit could fall, which could cause injury. 	<p>All accessories must be installed by an authorized technician.</p> <ul style="list-style-type: none"> The user must not try to install accessories. Improperly installed accessories can cause water leakage, electric shock or fire. Shortage in electrical circuit capacity or incomplete construction could cause fire, etc.
<p>Never modify the unit or repair it by yourself.</p> <ul style="list-style-type: none"> Modification or incorrect repair could cause electric shock, fire, etc. Consult the dealer from whom you purchased the unit. 	<p>Securely connect the specified remote control cord, and fix it so that the terminal connector is free from any external force via the cord.</p> <ul style="list-style-type: none"> Incomplete connection or fixing could cause heat, fire, etc.
<p>Do not move the unit by yourself.</p> <ul style="list-style-type: none"> Incomplete installation could cause electric shock, fire, etc. Ask the dealer or a specialist for installation. 	

⚠ CAUTION

<p>Do not install the unit in a place where flammable gas could leak.</p> <ul style="list-style-type: none"> If gas leaks or accumulates around the unit, it could cause ignition, explosion, etc. 	<p>Do not install the unit in a bathroom, kitchen, etc. where a great amount of steam is generated.</p> <ul style="list-style-type: none"> Avoid installing in a wall where condensation occurs. Installing in such a place could cause a fault, electric shock, etc.
<p>Do not use the unit in an abnormal environment.</p> <ul style="list-style-type: none"> Usage in a place where there is much oil (including machine oil), steam, sulfide gas, etc. could greatly degrade its performance or damage components. 	<p>Do not install the unit in a place where acid solution, alkaline solution, special spray, etc. are frequently used.</p> <ul style="list-style-type: none"> Installing in such a place could cause fault, electric shock, etc.
<p>Take sufficient countermeasures against noise when the unit is installed in hospital, communication office, etc.</p> <ul style="list-style-type: none"> This unit could malfunction when affected by inverter equipment, private electric generator, high-frequency medical instruments, radio communication devices, etc. Also, this unit could adversely affect medical instruments, communication devices, etc., thus interfering with human medical treatment, or causing disturbance in broadcast pictures or noise. 	
<p>When doing wiring, make sure that wires are not subject to tension.</p> <ul style="list-style-type: none"> Tension on wires could disconnect them, or cause heat, fire, etc. 	<p>Do not touch circuit boards with hands or tools, or allow dust to adhere to them.</p> <ul style="list-style-type: none"> Failure to do so could cause fault, fire, etc.
<p>Do not rinse this unit with water.</p> <ul style="list-style-type: none"> Doing so could cause fault, electric shock, etc. 	<p>Do not operate buttons with wet hands.</p> <ul style="list-style-type: none"> Failure to do so could cause fault, electric shock, etc.
<p>Do not install the unit in a place where the ambient temperature is over 40°C or below 0°C, or exposed to direct sunlight.</p> <ul style="list-style-type: none"> Installing in such a place could cause deformation, fault, etc. 	<p>Do not push buttons with sharp objects.</p> <ul style="list-style-type: none"> Failure to do so could cause fault, electric shock, etc.

2 Making Sure of Components

Make sure that the following components, along with this manual, are packed in the box. (Q'ty)

Component	PAC-SH91MK-E	PAR-SA92MW-E	PAR-SL93B-E
i-see sensor	1	-	-
Wireless remote controller receiver with i-see sensor	-	1	-
Wireless remote controller receiver	-	-	1
Wireless remote controller	-	1	1
Remote control holder	-	1	1
"AAA" LR03 alkaline batteries	-	2	2
4.1x16 wood screws	-	2	2
Cord retaining clips	-	2	2
Connection cord fixing seal (12x30 size)	-	1	1

3 How to Install

* Be sure to turn the power off before installing.

① Removing the intake grille and the right side panel

- Slide the catch holding the intake grille backwards to open the grille. Remove the screw holding the side panel, and then slide the side panel forward to remove it.

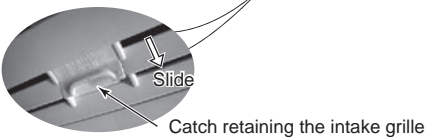
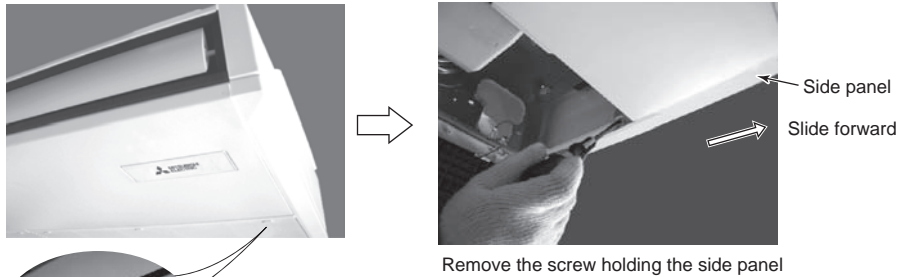

② Removing the existing brand label case

- Remove the brand label case (name plate with MITSUBISHI ELECTRIC) from the bottom right of the unit. If it is difficult to remove the case, use a flat-blade screwdriver, etc., taking care not to damage the panel.

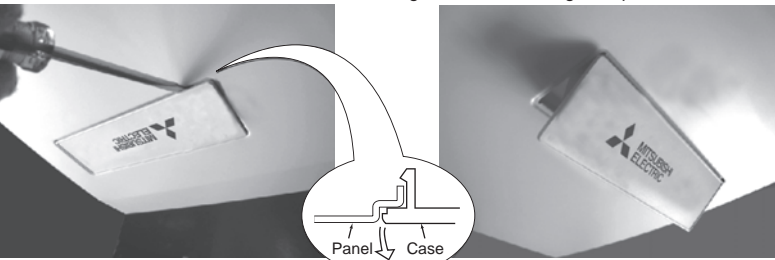

③ Installing to the indoor unit

- Pass the lead wire through the right side of the square hole to which the brand label case was attached, and then pull them through the slit in the right side of the bottom panel.
- Fit the receiver or i-see sensor into the square hole where the brand label case was attached.

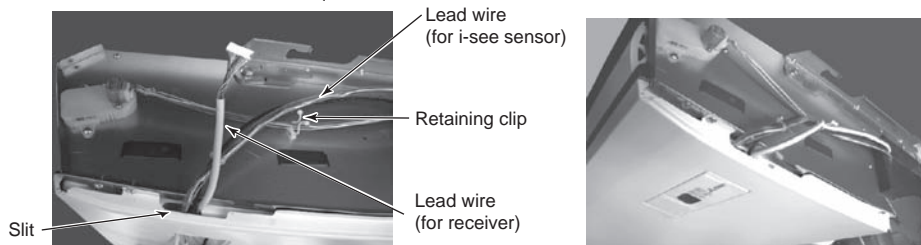

④ Laying out the lead wire

- Pass the lead wire through the retaining clips.
- Layout the lead wire along the vane motor lead wire, then fix them with the clips on the ceiling side of the unit.

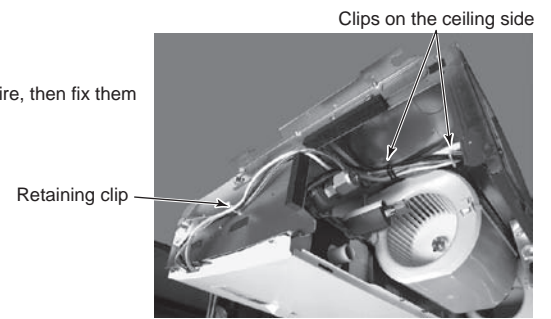

⑤ Removing the beam and the electrical box cover

- Remove the beam.
- Loosen the two screws at the bottom of the electrical box cover, and then slide the cover to the left to remove it.
- Pull down the electrical box.

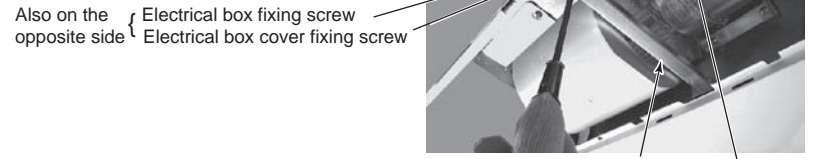

⑥ Connecting the receiver board connector to the control circuit board

<*only when wireless remote controller kit with i-see sensor PAR-SA92MW-E or wireless remote controller receiver PAR-SL93B-E is used.>

- Pass the cord through the bush at the top right of the electrical box.
- Connect the connector to CN90 on the right of the control board.
- If the cord is loose, bundle it using the clamps under the above bush.

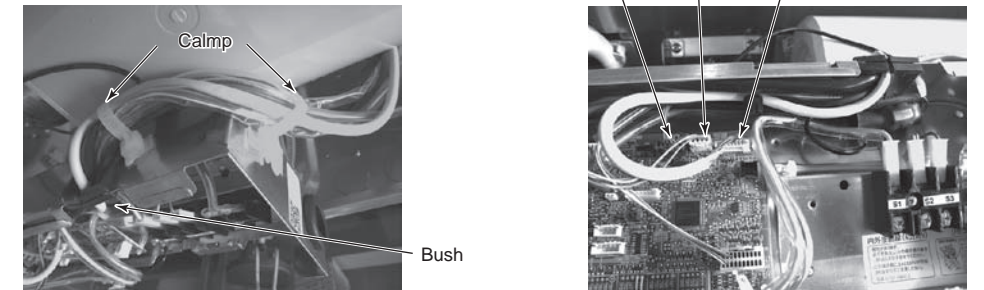

* The positions of the connectors may be different according to the model. Please refer to the wiring diagram to confirm the positions of the connectors.

⑦ Connecting the i-see sensor lead wire (radiation temp. sensor (black) and the stepping motor connector (transparent)) to the control circuit board

<*only when wireless remote controller receiver PAC-SH91MK-E or wireless remote controller kit with i-see sensor PAR-SA92MW-E is used.>

- Pass the cord through the bush at the top right of the electrical parts case.
- Connect the radiation temp. sensor (black) lead wire to CN4Y (white) on the control circuit board.
- Connect the stepping motor (transparent) lead wire to CN6Y (red) on the control circuit board.

⑧ Reinstalling the removed components

- Reinstall the removed components in reverse order. (The brand label case is not needed.)

⑨ Remote control holder

- To install the wireless remote controller on a wall, first attach the remote control holder to a wall.

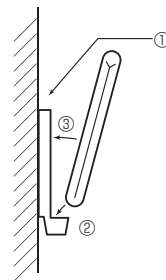

Fitting remote control into holder

- Fix the remote control holder to the wall using the 2 wood screws provided.
- Insert the remote control into the holder.
- Push the remote control against the wall.

Removing remote control

- Pull the top of remote control forward.

NOTE : The remote signal will reach the receiver over a distance of approx. 7m (23 ft.) in a straight line and approx. 45° left or right. If the infrared receiver is affected by fluorescent light (especially, inverter type), it may not be able to receive the signal. Take this into consideration when installing fluorescent lights or replacing them.

4 Pair Number Setting

- This is the setting to specify the unit to operate with the wireless remote controller.
- Make setting for J41, J42 (Jumper wire) of indoor controller board and the pair number of wireless remote controller.
- The pair number setting is available with the 4 patterns as shown in the following table. Make setting for the pair number (J41, J42) of indoor controller board and the pair number of wireless remote controller which is used as shown in the following table. *The initial setting is Pair No. "0".

- Press the SET button with something sharp at the end. Start this operation from the status of remote controller display turned off. **MODEL SELECT** blinks and Model No. is lighted.
- Press the \ominus button twice continuously. Pair No. "0" blinks.
- Press the temp. \odot button to set the pair number you want to set.
- Press the SET button with something sharp at the end. Set pair number is lighted for 3 seconds then turned off.

Pair No. of wireless remote controller	Indoor PC board
0	Initial setting
1	Cut J41
2	Cut J42
3-9	Cut J41, J42

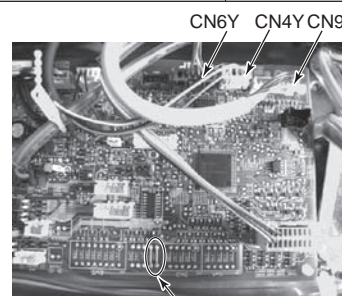

Jumper wire (J41, J42)

* The positions of the connectors may be different according to the model. Please refer to the wiring diagram to confirm the positions of the connectors.

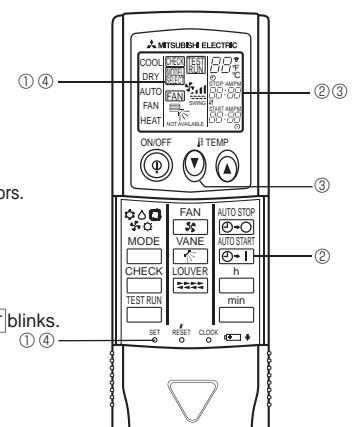
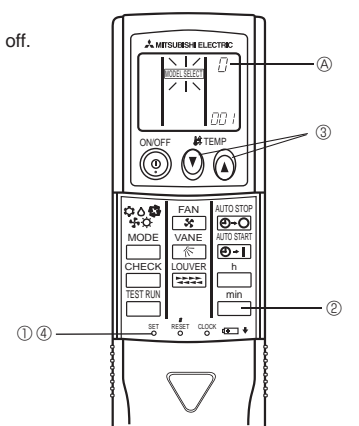

5 Function Selection of Wireless Remote Controller

- Temperature display °C/°F setting (Change of temp mode from °F to °C)

- Press the set button with something sharp at the end. **MODEL SELECT** blinks.
- Press the \ominus button. "F:" blinks.
- Press the \odot button. "C:" blinks.
- Press the SET button with something sharp at the end. **MODEL SELECT** is lighted for three seconds, then turned off.

6 Test Run

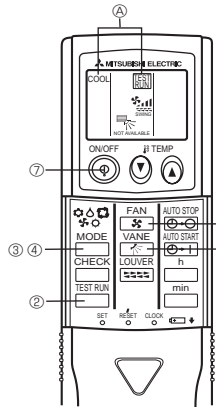

Measure an impedance between the power supply terminal block on the outdoor unit and the ground with a 500V Megger and check that it is equal to or greater than 1.0 MΩ.

- Turn on the main power to the unit.
- Press the **TEST RUN** button twice continuously.
(Start this operation from the status of remote controller display turned off.)
A **TEST RUN** and current operation mode are displayed.
- Press the **MODE** button (with fan icon) to activate COOL mode, then check whether cool air is blown out from the unit.
- Press the **MODE** button (with heat icon) to activate HEAT mode, then check whether warm air is blown out from the unit.
- Press the **FAN** button and check whether strong air is blown out from the unit.
- Press the **VANE** button and check whether the auto vane operates properly.
- Press the ON/OFF button to stop the test run.

NOTE : • Point the remote controller towards the indoor unit receiver while following steps ② to ⑦.
• It is not possible to run in FAN, DRY or AUTO mode.

7 Function Selection

This setting is available only for Mr. Slim model. CITY MULTI model can be set by dip switch of indoor/outdoor control circuit board. Refer to technical data of CITY MULTI model to set dip switch.

Each function can be set according to necessity using the remote controller. The setting of function for each unit can only be done by the remote controller. Select function available from the Table 3. Function selection using wireless remote controller is available only for refrigerant system with wireless function. Refrigerant address cannot be specified by the wireless remote controller. The article below describes how to set "LOSSNAY connectivity" into "supported (indoor unit is not equipped with outdoor-air intake)" in Table 3 as an example.

- Go to the function select mode
Press the **CHECK** button twice continuously.
(Start this operation from the status of remote controller display turned off.)
CHECK is lighted and "00" blinks.
- Setting the unit number
Press the temp button once to set "50". Direct the wireless remote controller toward the receiver of the indoor unit and press the **h** button.
- Selecting a mode
Enter 03 to change the LOSSNAY connectivity setting using the **h** button and **h** button.

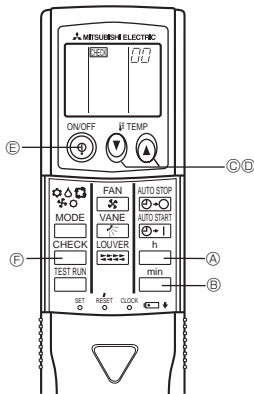

- Current setting number: 1=1 beep (1 second)
2=2 beeps (1 second each)
3=3 beeps (1 second each)
- If a mode number that can not be recognized by the unit is entered, 3 beeps (3 beeps of 0.4 seconds duration) will be heard. Reenter the mode number selecting.
 - If the signal was not received by the sensor or an error occurred during transmission, you will not hear a beep or a "double beep" may be heard. Press the **h** button again.
- Selecting the setting number
Use the **h** and **h** buttons to change the LOSSNAY connectivity setting to 02. Direct the wireless remote controller toward the sensor of the indoor unit and press the **h** button.
→ At this time, current setting number for selected mode number will be output by the interrupted buzzer sounds and the blinks of operation indicator.
Output : setting number = 1 → beep beep (0.4 second + 0.4 second) x1
2 → beep beep (0.4 second + 0.4 second) x2
3 → beep beep (0.4 second + 0.4 second) x3
- If a setting number that can not be recognized by the unit is entered, 3 beeps (3 beeps of 0.4 seconds duration) will be heard (unit will beep only). Reenter the setting number selecting.
 - If the signal was not received by the sensor or an error occurred during transmission, you will not hear a beep or a "double beep" may be heard. Press the **h** button again.
 - If the number that can not be set is input, the former setting number will be set.
- To select multiple functions continuously
Repeat steps ③ and ④ to change multiple function settings continuously.
 - Complete function selection
Direct the wireless remote controller toward the sensor of the indoor unit and press the **h** button.

NOTE : Whenever changes are made to the function settings after construction or maintenance, be sure to record the added functions with an "O", in the "Check" column provided on the chart.

Other function selections
Now that you know how to change LOSSNAY connectivity setting, there are several other settings that can be changed as well. The following table lists the various settings that can be changed through the remote controller and the default settings.

Function	Settings	PCA-A-KA
Power failure automatic recovery	Not available	*1
	Available	*1
Indoor temperature detecting	Indoor unit operating average	○
	Set by indoor unit's remote controller	
	Remote controller's internal sensor	
LOSSNAY connectivity	Not supported	○
	Supported (indoor unit is not equipped with outdoor-air intake)	
Auto mode (only for PUZ)	Energy saving cycle automatically enabled	○
	Energy saving cycle automatically disabled	
Filter sign	100Hr	
	2500Hr	○
	No filter sign indicator	
Fan speed	Quiet	
	Standard	○
	High ceiling	
Up/down vane setting	No vanes	
	Equipped with vanes (No.1 set)	○
	Equipped with vanes (No.2 set)	

*1 Power failure automatic recovery initial setting depends on the connecting outdoor unit.

Things to remember when entering function selections:
The basic procedure for entering function selections is the same as described for switching between LOSSNAY connectivity. However, there are some differences at step ② for selecting the unit number, step ③ for selecting the mode number and step ④ for selecting the setting number.

The following Tables 4 and 5 list the various function settings, mode numbers and setting numbers.
Table 4 details the function of the entire refrigerant system while Table 5 shows the function that can be set for the indoor unit.

Table 4. Itemized functions of the entire refrigerant system (select unit number 00)

Mode	Settings	Mode no.	Setting no.	Check	Remarks
Power failure automatic recovery	Not available	01	1		Approximately 4-minutes wait-period after power is restored.
	Available (Approximately 4-minutes wait-period after power is restored.)		2		
Indoor temperature detecting	Indoor unit operating average	02	1		
	Set by indoor unit's remote controller		2		
	Remote controller's internal sensor		3		
LOSSNAY connectivity	Not supported	03	1		
	Supported (indoor unit is not equipped with outdoor-air intake)		2		
	Not supported (indoor unit is not equipped with outdoor-air intake)		3		
Auto mode (only for PUZ)	Energy saving cycle automatically enabled	05	1		
	Energy saving cycle automatically disabled		2		

Table 5. Itemized functions of the indoor unit (select unit numbers 01 to 02 or 07)

Mode	Settings	Mode no.	Setting no.	Check	Remarks
Filter sign	100Hr	07	1		
	2500Hr		2		
	No filter sign indicator		3		
Fan speed	Quiet	08	1		
	standard		2		
	High ceiling		3		
Up/down vane setting	No vanes	11	1		
	Equipped with vanes (No.1 set)		2		
	Equipped with vanes (No.2 set)		3		

- Setting the unit numbers
Set "00" as the unit number when setting function from Table 4.
When setting function from Table 5.
- When setting function for an indoor unit in an independent system, set the unit number to 01.
- When setting function for a simultaneous-Twin indoor unit system, assign unit numbers from 01 to 02 to each indoor unit.
- When setting the same functions for an entire simultaneous Twin-indoor unit system, assign "07" as the unit number.
- Selecting the mode number
Select from Table 4 and Table 5.
- Selecting the setting number.

8 Self-Check

- Turn on the main power to the unit.
- Press the **CHECK** button twice continuously.
(Start this operation from the status of remote controller display turned off.)
A **CHECK** begins to light.
B «00» begins to blink.
- While pointing the remote controller toward the unit's receiver, press the **h** button. The check code will be indicated by the number of times that the buzzer sounds from the receiver section and the number of blinks of the operation lamp.
- Press the ON/OFF button to stop the self-check.

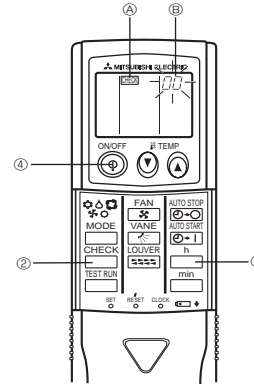

Refer to the following tables for details on the check codes.

① Output pattern (Mr.Slim model / CITY MULTI model)

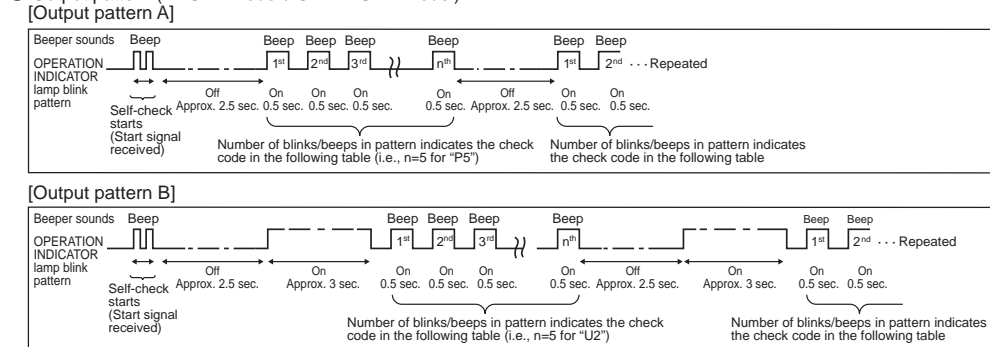

② Check code (Mr.Slim model)

Wireless remote controller	Wired remote controller	Symptom	Remark
Beeper sounds/OPERATION INDICATOR lamp blinks (Number of times)	Check code		
1	P1	Intake sensor error	
2	P2, P9	Pipe (Liquid or 2-phase pipe) sensor error	
3	E6, E7	Indoor/outdoor unit communication error	
4	P4	Drain sensor error/Float switch connector open	
5	P5	Drain pump error	
6	P6	Freezing/Overheating safeguard operation	
7	EE	Communication error between indoor and outdoor units	
8	P8	Pipe temperature error	
9	E4	Remote controller signal receiving error	
10	-	-	
11	-	-	
12	Fb	Indoor unit control system error (memory error, etc.)	
No sound	--	No corresponding	

③ Output pattern B] Errors detected by unit other than indoor unit (outdoor unit, etc.)

Wireless remote controller	Wired remote controller	Symptom	Remark
Beeper sounds/OPERATION INDICATOR lamp blinks (Number of times)	Check code		
1	E9	Indoor/outdoor unit communication error (Transmitting error) (Outdoor unit)	For details, check the LED display of the outdoor controller board.
2	UP	Compressor overcurrent interruption	
3	U3, U4	Open/short of outdoor unit thermistors	
4	UF	Compressor overcurrent interruption (When compressor locked)	
5	U2	Abnormal high discharging temperature/insufficient refrigerant	
6	U1, Ud	Abnormal high pressure (63H worked)/Overheating protection operation	
7	U5	Abnormal temperature of heat sink	
8	U8	Outdoor unit fan protection stop	
9	U6	Compressor overcurrent interruption/Abnormal of power module	
10	U7	Abnormality of super heat due to low discharge temperature	
11	U9, UH	Abnormality such as overvoltage or voltage shortage and abnormal synchronous signal to main circuit/Current sensor error	
12	-	-	
13	-	-	
14	Others	Other errors (Refer to the technical manual for the outdoor unit.)	

- *1 If the beeper does not sound again after the initial 2 beeps to confirm the self-check start signal was received and the OPERATION INDICATOR lamp does not come on, there are no error records.
- *2 If the beeper sounds 3 times continuously "beep, beep, beep (0.4 + 0.4 + 0.4 sec.)" after the initial 2 beeps to confirm the self-check start signal was received, the specified refrigerant address is incorrect.

- On wireless remote controller
The continuous buzzer sounds from receiving section of indoor unit.
Blink of operation lamp
- On wired remote controller
Check code display in the LCD.

③ Check code (CITY MULTI model)

Wireless remote controller	Wired remote controller	Remark
Beeper sounds/OPERATION INDICATOR lamp blinks (Number of times)	Check code	
1	1000 ~ 1999	
2	2000 ~ 2999	
3	3000 ~ 3999	
4	4000 ~ 4999	
5	5000 ~ 5999	
6	6000 ~ 6999	
7	7000 ~ 7999	
8	0000 ~ 0999	
9	8000 over	

- *1 Refer to service handbook of outdoor unit for the detail.
 - *2 If the beeper does not sound again after the initial 2 beeps to confirm the self-check start signal was received and the OPERATION INDICATOR lamp does not come on, there are no error records.
 - *3 If the beeper sounds 3 times continuously "beep, beep, beep (0.4 + 0.4 + 0.4 sec.)" after the initial 2 beeps to confirm the self-check start signal was received, the specified address is incorrect.
- On wireless remote controller
The continuous buzzer sounds from receiving section of indoor unit.
Blink of operation lamp
 - On wired remote controller
Check code display in the LCD.