

SUBMITTAL DATA: PEAD-A36AA7 & PUZ-A36NKA7
36,000 BTU/H HORIZONTAL-DUCTED HEAT-PUMP SYSTEM

Job Name:	Engineer:
Purchaser:	Application:
Submitted To:	For: <input type="checkbox"/> Reference <input type="checkbox"/> Approval <input type="checkbox"/> Construction
Submitted By:	Location:
System Designation:	Schedule No.:



UNIT OPTION:

Standard Model.....PUZ-A36NKA7

ACCESSORIES:

Indoor Unit

- Filter Box (PAC-KE94TB-E)
- External Heating Adaptor (PAC-YU25HT)

Controls

- Wireless Controller (MHK2)
- Advanced Wired Controller (PAR-40MAA)
- Simple Wired Controller (PAC-YT53CRAU)
- Wireless Remote Controller (PAR-FL32MA) + Wireless Signal Receiver (PAR-FA32MA)
- Thermostat Interface (PAC-US444CN)
- M-NET Adapter (PAC-SJ95MA-E)

Outdoor Unit

- Rear Snow Guard (SG-1-RE)
 - Side Snow Guard (SG-1-SD)
 - Front Wind Deflector (x2 required) (CM-S-FR-NKMU)
 - Front Wind Blocker (x2 per box) (CM-S-BLK-NKMU)
- Note: Mitsubishi Electric (MESCA) supports the use of only MESCA supplied and approved Snow Guard / Wind Deflectors / Windscreens and accessories for proper functioning of the unit(s). Use of non-MESCA supported Snow Guard / Wind Deflectors / Windscreens and accessories will affect warranty coverage.**

SPECIFICATIONS:

Rated Conditions (Capacity / Input)*		
Cooling	Btu/h / W	36,000 / 3,000
Heating at 47° F	Btu/h / W	38,000 / 2,410
Heating at 17° F	Btu/h / W	20,800 / 2,350

* Rating Conditions per AHRI Standard:
Cooling | Indoor: 80° F (27° C)DB / 67° F (19° C)WB; Outdoor: 95° F (35° C)DB / 75° F (24° C)WB
Heating at 47° F | Indoor: 70° F (21° C)DB / 60° F (16° C)WB; Outdoor: 47° F (8° C)DB / 43° F (6° C)WB
Heating at 17° F | Indoor: 70° F (21° C)DB / 60° F (16° C)WB; Outdoor: 17° F (-8° C)DB / 15° F (-9° C)WB

Capacity Range		
Cooling	Btu/h	16,000 - 36,000
Heating at 47° F	Btu/h	18,200 - 40,000

Operating Range	
Cooling	0°F** (-18°C) to 115°F (46°C) DB
Heating	-4°F (-20°C) to 70°F (21°C) DB

** Windscreens required for cooling operation below 23°F (-5°C)

AHRI Efficiency Rating	
EER	12.0
SEER	19.1
HSPF IV / V	9.9 / 7.3
COP at 47° F	4.62
COP at 17° F	2.60

Electrical Power Requirements	208 / 230V, 1-Phase, 60 Hz
-------------------------------	----------------------------

Minimum Circuit Ampacity (MCA) *		Breaker Size	MOCP (Outdoor)
Indoor 3.30 AMP	Outdoor 25 AMP	30 AMP	31 AMP

***All electrical work shall comply with National (CEC) and local codes and regulations.**

Indoor Unit			
Blower Motor (ECM)	F.L.A.	2.64	
Blower Motor Output	W	244	
SHF / Moisture Removal		0.75 / 8.1 pt./h	
External Static Pressure	In. WG	0.14-0.20-0.28-0.40-0.60	
Drain Lift Mechanism (Included)	H: In.	27-9/16	Drainpipe Size O.D [in. (mm)] - 1-1/4 (32)

Outdoor Unit		
Compressor	DC INVERTER-driven Scroll	
Fan Motor (ECM)	F.L.A.	0.5+0.5
Fan Motor Power	W	74

Airflow Rate (Low-Mid-Hi)			
Indoor (Cooling)	DRY	CFM	847-1,024-1,201
	WET		807-984-1,161
Outdoor	DRY		3,880

Sound Pressure Level		
Indoor (Low-Mid-Hi)		33-38-42
Outdoor	Cooling	52
	Heating	53

External Dimensions		
Indoor (H x W x D)	In.(mm)	9-7/8 x 55-1/8 x 28-7/8 (250 x 1,400 x 732)
Outdoor (H x W x D)		52-11/16 x 41-5/16 x 13 + 1-3/16 (1,338 x 1050 x 330 + 30)

Net Weight		
Indoor	Lbs.(kg)	86 (39)
Outdoor		214 (97)

External Finish	
Indoor	Galvanized-steel Sheet
Outdoor	Ivory Munsell No. 3Y 7.8 / 1.1

Refrigerant	R410A ; 10lbs., 6oz. (4.7kg)
-------------	------------------------------

Refrigerant Piping (Flared)		
Liquid (High Pressure)	In.(mm)	3/8 (9.52)
Gas (Low Pressure)		5/8 (15.88)
Maximum Total Refrigerant Pipe Length	Fl. (m)	165 (50)
Maximum Vertical Separation	Fl. (m)	100 (30)

FAN PERFORMANCE AND CORRECTED AIR FLOW - PEAD-A36AA(7)(8)

PEAD-A36AA7

(External static pressure 35Pa) 208-230V 60Hz

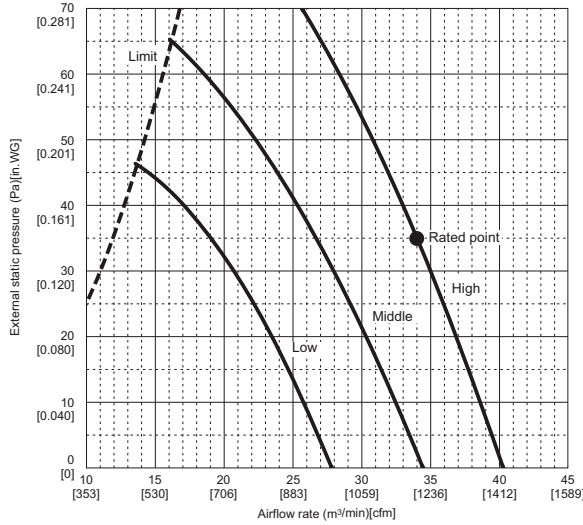

PEAD-A36AA7

(External static pressure 100Pa) 208-230V 60Hz

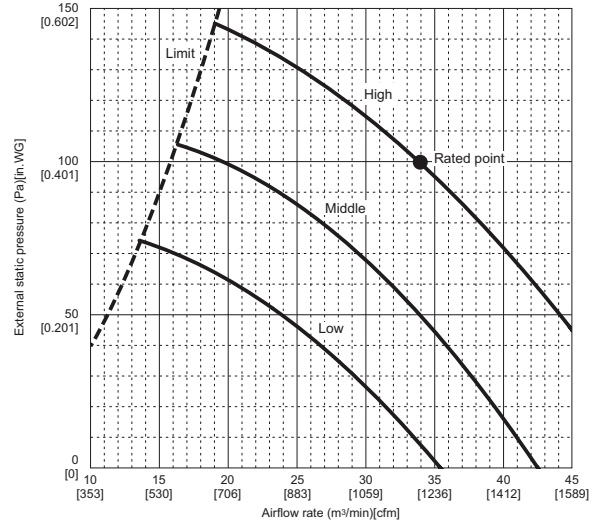

PEAD-A36AA7

(External static pressure 50Pa) 208-230V 60Hz

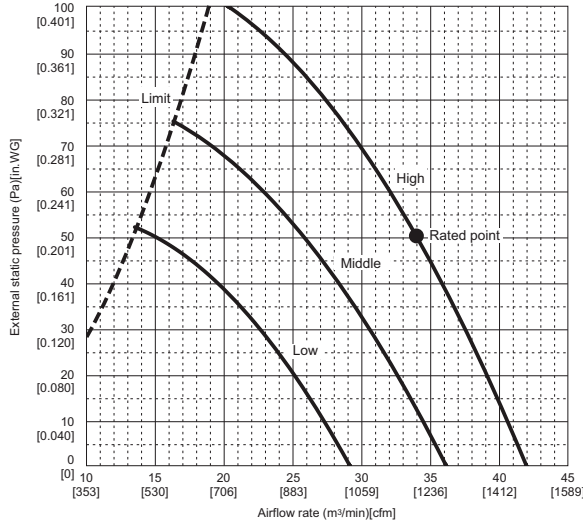

PEAD-A36AA7

(External static pressure 150Pa) 208-230V 60Hz

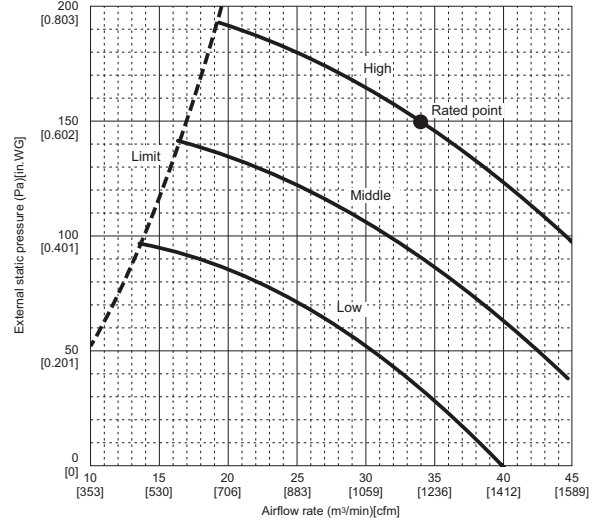

PEAD-A36AA7

(External static pressure 70Pa) 208-230V 60Hz

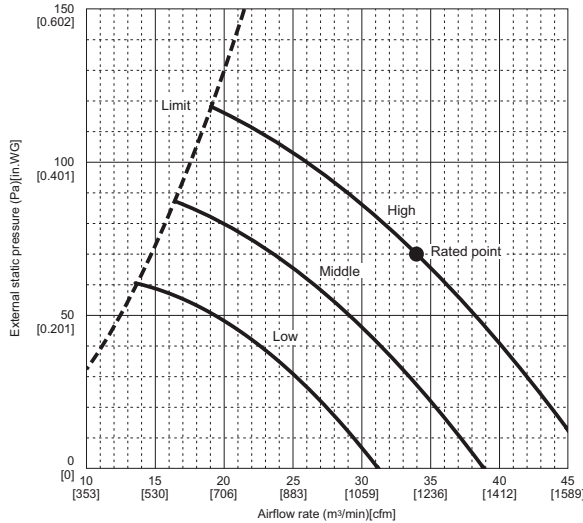

PEAD-A12,18,24,30,36,42AA7

Air filter 208-230V 60Hz

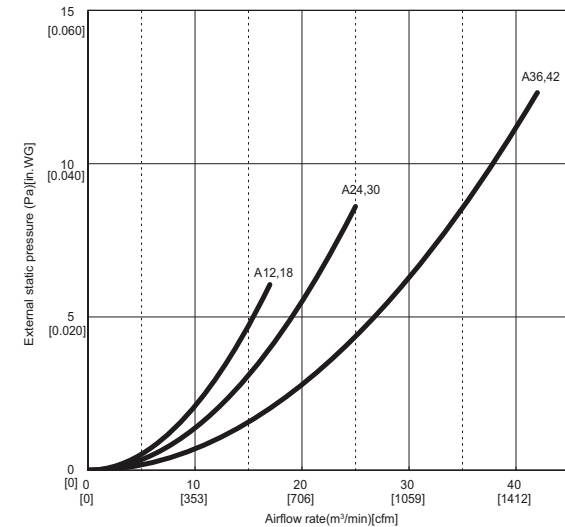

Specifications are subject to change without notice.

Should this document be altered or changed without MESCA's permission, it becomes null and void. MESCA assumes no responsibility for any consequences in such cases.

DIMENSIONS: PEAD-A36AA(7)(8)

Unit: mm (in.)

- Note**
1. Use an M10 screw for the suspension bolt (field supply).
 2. Keep the service space for maintenance at the bottom.
 3. This drawing is for PEAD-A24-30-36-42 AA7 models, which have 2 fans. PEAD-A12-18AA7 models have 1 fan.
 4. If the inlet duct is used, remove the air filter (supplied with the unit), then install the filter (field supply) at the suction side.
 5. Heat air to 0°C (32°F) or higher when taking fresh air with a fresh air intake.

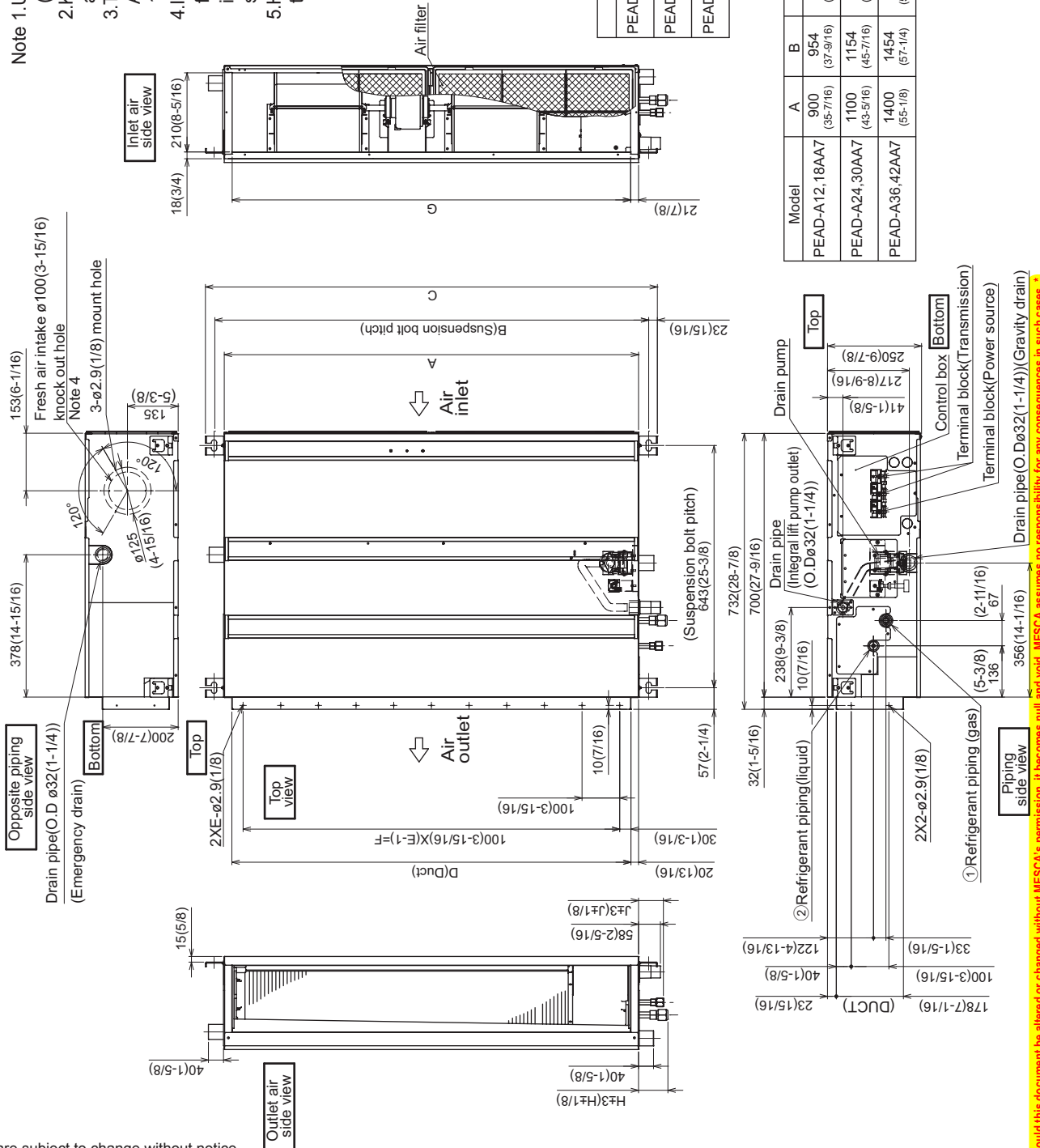

Model	J	① Gas pipe	② Liquid pipe
PEAD-A12,18AA7	62 (2-1/2)	ø12.7 (1/2)	ø6.35 (1/4)
PEAD-A24,30AA7	66 (2-5/8)	ø15.88 (5/8)	ø9.52 (3/8)
PEAD-A36,42AA7			

Model	A	B	C	D	E	F	G	H
PEAD-A12,18AA7	900 (35-7/16)	954 (37-9/16)	1000 (39-3/8)	860 (33-7/8)	9	800 (31-1/2)	858 (33-13/16)	72 (2-7/8)
PEAD-A24,30AA7	1100 (43-5/16)	1154 (45-7/16)	1200 (47-1/4)	1060 (41-3/4)	11	1000 (39-3/8)	1058 (41-11/16)	78 (3-1/8)
PEAD-A36,42AA7	1400 (55-1/8)	1454 (57-1/4)	1500 (59-1/16)	1360 (53-9/16)	14	1300 (51-3/16)	1358 (53-1/2)	

Specifications are subject to change without notice.

Should this document be altered or changed without MESCA's permission, it becomes null and void. MESCA assumes no responsibility for any consequences in such cases.

DIMENSIONS: PEAD-A36AA(7)(8)

Unit: mm (in.)

[Maintenance access space]

Secure enough access space to allow for the maintenance, inspection, and replacement of the motor, fan, drain pump, heat exchanger, and control box in one of the following ways.

Select an installation site for the indoor unit so that its maintenance access space will not be obstructed by beams or other objects.

- (1) When a space of 300mm or more is available below the unit between the unit and the ceiling,
 - Create access door 1 and 2 (450x450mm each) as shown in Fig.2.
 - (Access door 2 is not required if enough space is available below the unit for a maintenance worker to work in.)
- (2) When a space of less than 300mm is available below the unit between the unit and the ceiling.
 - (At least 20mm of space should be left below the unit as shown in Fig.3.)
 - Create access door 1 diagonally below the control box and access door 3 below the unit as shown in Fig.4.
 - Create access door 4 below the control box and the unit as shown in Fig.5.

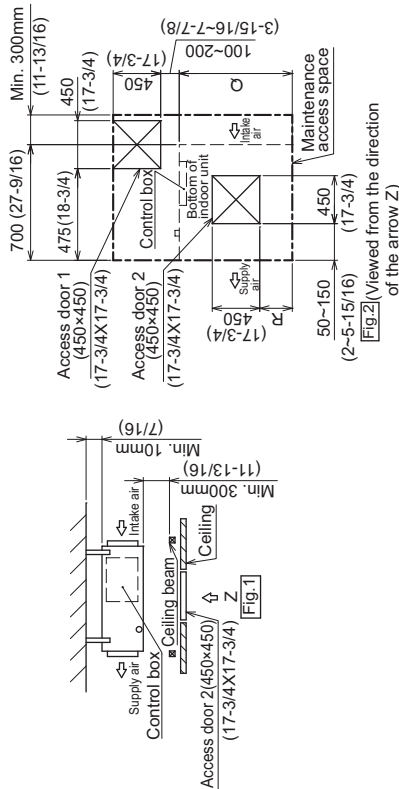
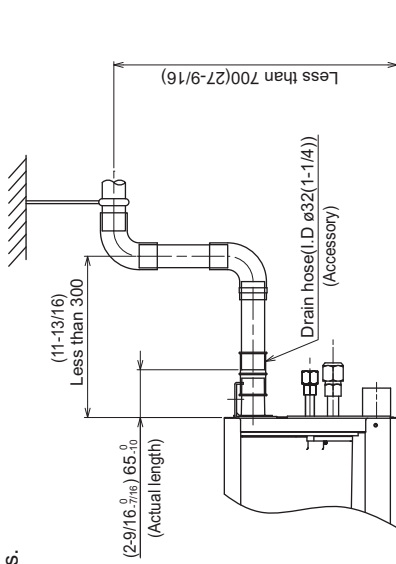

Fig.2 (Viewed from the direction of the arrow Z)

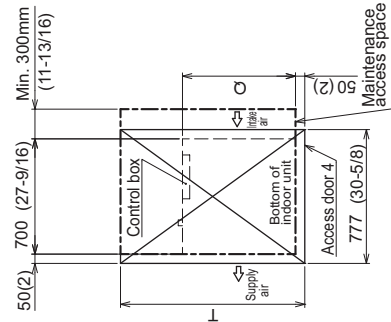

Fig.3 (Viewed from the direction of the arrow Y)

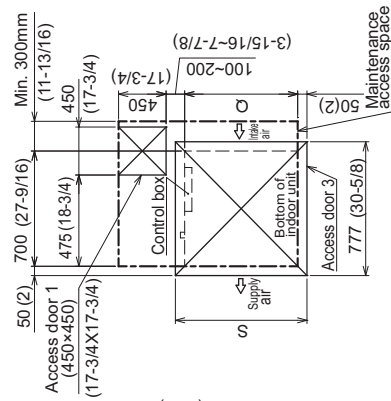

Fig.4 (Viewed from the direction of the arrow Y)

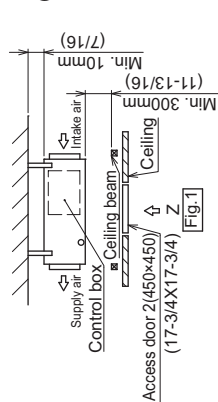

Fig.1

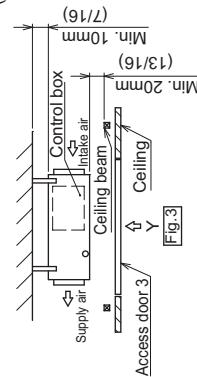
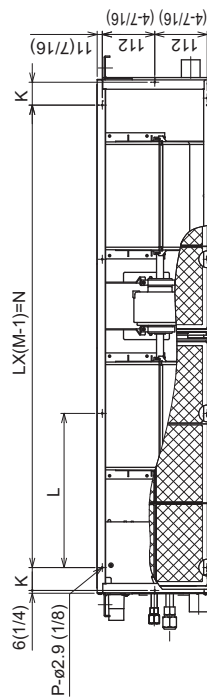

Fig.3



Model	K	L	M	N	P	Q	R	S	T
PEAD-A12.18AA7	54 (2-3/16)	260 (10-1/4)	4 (30-3/4)	780 (30-3/4)	10 (35-7/16)	900 (5-15/16)-9(7/8)	150-250 (5-15/16)-9(7/8)	1000 (39-3/8)	1500 (59-11/16)
PEAD-A24.30AA7	49 (1-15/16)	330 (13)	4 (39)	990 (40-1/2)	10 (40-3/16)	1100 (9-7/8)-13(13/16)	250-350 (9-7/8)-13(13/16)	1200 (47-1/4)	1700 (66-15/16)
PEAD-A36.48AA7	54 (2-3/16)	320 (12-5/8)	5 (60-7/16)	1280 (50-11/16)	12 (55-1/8)	1400 (55-1/8)	400-500 (15-3/4)-19(11/16)	1500 (59-11/16)	2000 (78-3/4)

DIMENSIONS: PUZ-A36NKA7

Unit: mm (in.)

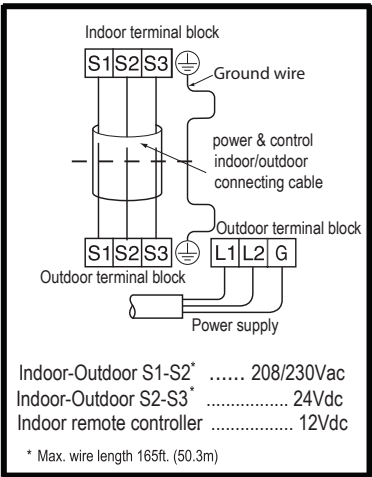
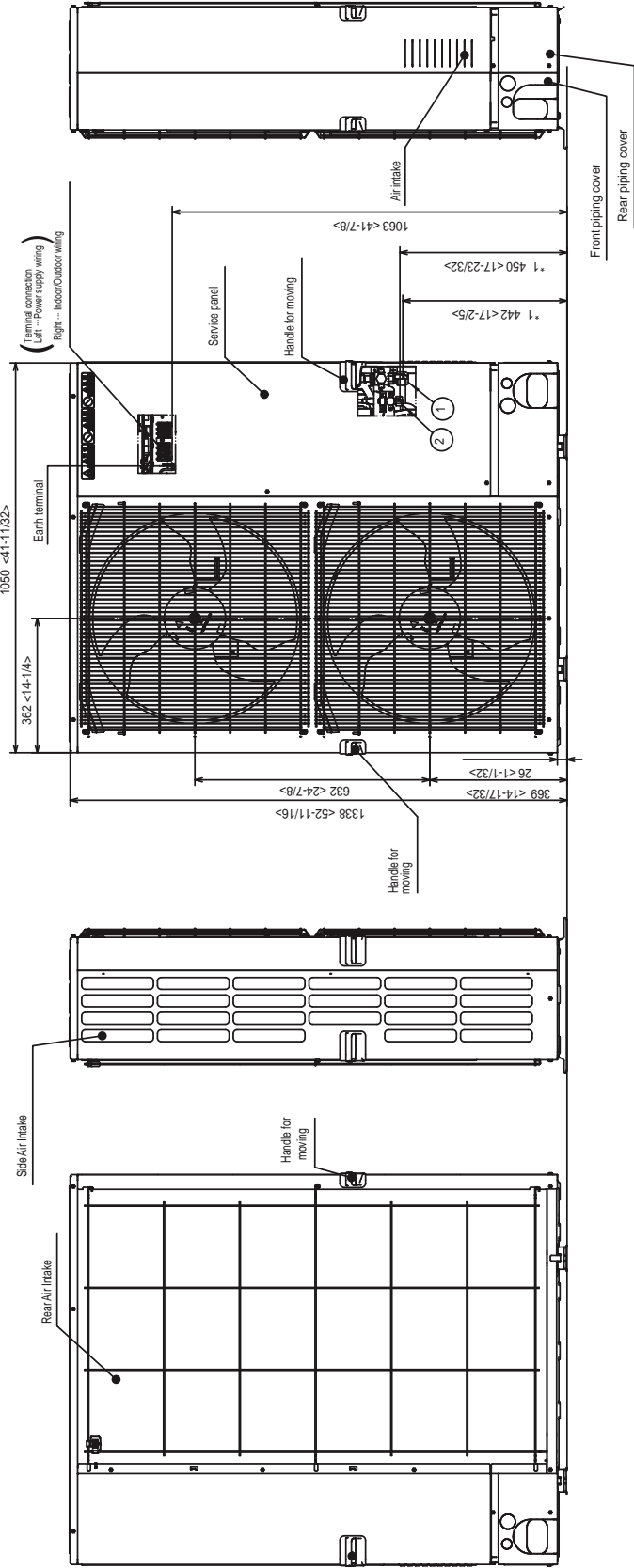
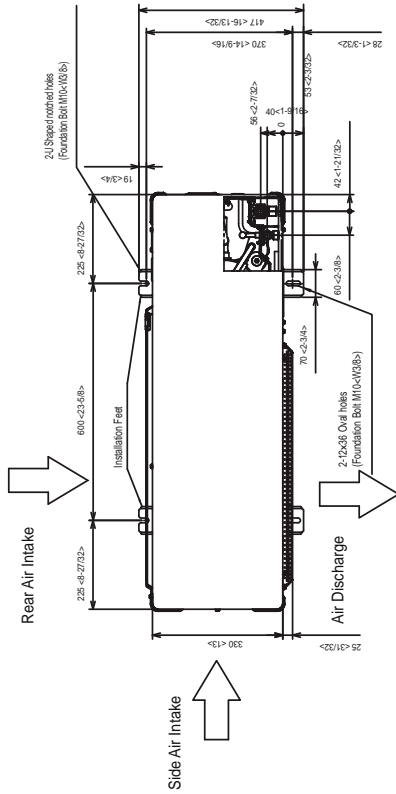

Example of Notes

- ① ... Refrigerant GAS pipe connection (FLARE) ϕ 15.88(5/8F)
- ② ... Refrigerant LIQUID pipe connection (FLARE) ϕ 8.52(3/8F)
- * ... Indication of STOP VALVE connection location.

Should this document be altered or changed without MESCA's permission, it becomes null and void. MESCA assumes no responsibility for any consequences in such cases.

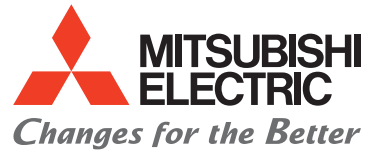

Specifications are subject to change without notice.
 www.MitsubishiElectric.ca
 © 2022 Mitsubishi Electric Sales Canada Inc.