

Submittal Data: PLA-A24EA7R1-TH & PUZ-HA24NHA1

24,000 BTU/H Ceiling-Cassette Cold Climate Heat Pump System

Job Name:	Location:		
Purchaser:	Submitted By:		
Submitted To:	Reference:	Approval:	Construction:
Engineer:	Date:	Application:	



Optional Controller

Images provided for reference purposes only

Outdoor Standard Features:	Description:
Blue Fin Coating	Prolong condenser operating life
Inverter Motor	Energy efficient operation with variable speed DC motor
Built in base pan heater	Automated control to prevent premature failure of condenser coil
Auto mode	Automatically switches between heating & cooling modes
Fast Auto restart	Automatically restarts after power failure return
Auxiliary heat lock out	Prevents premature activation of aux. heat
Automated compressor cutout	Prevents inefficient operation & protects compressor
Cold climate heat pump	

Indoor Standard Features:
Built-in condensate lift mechanism
Filter change indicator signal
Washable filter

Description: (Optional Accessories)	Model No.
Front Windscreen	PFR-24-30
Rear Snow Guard	PRE-24-30
Side Snow Guard	PSD-24-30
Grille w/ i-see Sensor (Required Sold Separately)	PLP-41EAEU
Flange for fresh air intake	PAC-SH650F-E
Distribution Pipe used for Twinning	MSDD-50TR-E (refer to manual)

Note:

- Mitsubishi Electric Sales Canada Inc. (MESCA) supports the use of only MESCA supplied and approved components and accessories for proper functioning of the unit(s). Use of non - MESCA supported components and accessories will affect warranty coverage. MESCA recommends (A) consideration of all applicable design and application parameters and requirements specific to any project.
- Should any person change this document in any manner whatsoever without MESCA's written permission, the document shall be of no force and effect and any change shall be deemed to be a representation and warranty made by that person and not MESCA. That person, and not MESCA, shall assume full responsibility for the consequences of such changes. MESCA assumes no responsibility for any consequences in such cases.

Submittal Data: PLA-A24EA7R1-TH & PUZ-HA24NHA1

Performance:

Cooling at 95°F ¹	Rated Capacity	Btu/h	24,000
	Capacity Range	Btu/h	10,000 - 24,000
	Rated Power Input	W	1,710
	Power Input Range	W	700 - 1,710
	Moisture Removal	pints/h	3.0
	Sensible Heat Factor		0.86
Heating at 47°F ²	Rated Capacity	Btu/h	26,000
	Capacity Range	Btu/h	10,000 - 28,000
	Rated Power Input	W	1,700
	Power Input Range	W	510 - 1,900
Heating at 17°F ³	Maximum Capacity	Btu/h	26,000
	Rated Capacity	Btu/h	17,300
	Capacity Range	Btu/h	NA - 26,000
	Maximum Power Input	W	3,000
	Rated Power Input	W	1,816
	Power Input Range	W	NA - 3,678
Heating at 5°F ⁴	Maximum Capacity	Btu/h	26,000
	Maximum Power Input	W	3,865
Heating at -13°F ⁵	Maximum Capacity	Btu/h	20,800
	Maximum Power Input	W	3,948

Efficiency:

SEER		21.5
EER ¹		14.0
HSPF (IV)		11.3
COP at 47°F ²	Rated Capacity	4.48
COP at 17°F ³	Maximum Capacity	2.54
COP at 5°F ⁴	Maximum Capacity	1.97

Electrical:

Power Supply		208/230V, 1Ph, 60Hz
Voltage: Indoor - Outdoor, S1-S2	V AC	AC 208/230V
Voltage: Indoor - Outdoor, S2-S3	V DC	DC 24V
Short-circuit Current Rating (SCCR)	kA	5
Recommended Fuse/Breaker Size (Outdoor)	A	25
Recommended Wire Size (Indoor - Outdoor)	AWG	14

Outdoor Operating Temperature Range:

Cooling Operation Air Temp (Maximum / Minimum)*	°F (°C)	* 0 to 115 (-18 to 46)
Cooling Operation Thermal Lock-out / Re-start Temperatures	°F (°C)	-1 / 3 (-18 / -16)
Heating Operation Air Temp (Maximum / Minimum)	°F (°C)	-13 to 75 (-25 to 24)
Heating Operation Thermal Lock-out / Re-start Temperatures	°F (°C)	-22 / -13 (-30 / -25)

AHRI Rated Conditions (Rated data is determined at a fixed compressor speed) (* Windscreens required for cooling operations below 23°F (-5°C))

¹Cooling (Indoor // Outdoor) 80°F (26.6°C) DB, 67°F (19.4°C) WB // 95°F (35°C) DB, 75°F (23.9°C) WB

²Heating at 47°F (8.3°C) (Indoor // Outdoor) 70°F (21.1°C) DB, 60°F (15.6°C) WB // 47°F (8.3°C) DB, 43°F (6.1°C) WB

³Heating at 17°F (-8.3°C) (Indoor // Outdoor) 70°F (21.1°C) DB, 60°F (15.6°C) WB // 17°F (-8.3°C) DB, 15°F (-9.4°C) WB

Rated conditions:

⁴Heating at 5°F (-15°C) (Indoor // Outdoor) 70°F (21.1°C) DB, 60°F (15.6°C) WB // 5°F (-15°C) DB, 4°F (-15.6°C) WB

⁵Heating at -13°F (25°C) (Indoor // Outdoor) 70°F (21.1°C) DB, 60°F (15.6°C) WB // -13°F (-25°C) DB, -15°F (-26.1°C) WB

Notes:

Submital Data: PLA-A24EA7R1-TH & PUZ-HA24NHA1

Indoor Unit Specifications:

MCA	A	1.00	
Blower Motor Full Load Amperage	A	0.49	
Blower Motor Output	W	120	
Airflow Rate at Cooling, Dry	CFM	530 - 640 - 710 - 810	
Airflow Rate at Cooling, Wet	CFM	490 - 600 - 670 - 770	
Airflow Rate at Heating, Dry	CFM	530 - 640 - 710 - 810	
Sound Pressure Level (Cooling)	dB(A)	28 - 30 - 33 - 36	
Sound Pressure Level (Heating)	dB(A)	28 - 30 - 33 - 36	
Drain Pipe Size	In. (mm)	1-1/4 (32)	
External Finish Color [Panel]		Munsell 1.0Y 9.2/0.2	
Dimensions		Main Unit	Panel
	W: In. (mm)	33-1/16 (840)	37-13/32 (950)
	D: In. (mm)	33-1/16 (840)	37-13/32 (950)
	H: In. (mm)	11-3/4 (298)	1-9/16 (40)
Unit Weight	Lbs. (kg)	56 (25)	11 (5)

Outdoor Unit Specifications:

MCA	A	17
MOCP	A	27
Fan Motor Output	W	74
Airflow Rate (Cooling/Heating)	CFM	1,940 / 1,940
Sound Pressure Level, Cooling1	dB(A)	52
Sound Pressure Level, Heating2	dB(A)	53
Refrigerant Control		LEV
Compressor Oil Type / Charge	oz.	FVC68D / 34 oz
External Finish Color		Ivory Munsell No.3Y 7.8/1.1
Unit Weight	Lbs. (kg)	190 (86)
Unit Dimensions	W: In. (mm)	37-13/32 (950)
	D: In. (mm)	12-63/64 + 63/64 (330 + 25)
	H: In. (mm)	37-1/8 (943)
Gas Pipe Size O.D. (Flared)	In. (mm)	5/8 (15.88)
Liquid Pipe Size O.D. (Flared)	In. (mm)	3/8 (9.52)
Maximum Piping Length	Ft. (m)	165 (50)
Maximum Height Difference	Ft. (m)	100 (30)

Description: (Optional Controls)

Model No.

Building automated system DDC Interface	MELCO-RETAIL-MINI
Building automated system BacNet Interface	MELCO-BEMS-MINI
Wireless MA Remote Controller	PAR-FL32MA-E
Operation/error display adapter	PAC-SA88HA-EP
Remote ON/OFF control	PAC-SE55RA-E
Remote Compressor ON/OFF control	PAC-SC36NA-E
Remote Controller Infrared Receiver	PAR-SR4LU-E
Wireless remote receiver	PAR-SL100A-E
Wired wall mounted remote control	PAR-40MAA
Wireless wall mounted remote control	MHK1
Touch screen wired wall mounted control	PAR-CT01MAU-SB
Remote Operation Adapter	PAC-SF40RM-E
Basic wired wall mounted control	PAC-YT53CRAU-J
Auxiliary Heat (CN24) Cable	PAC-SE56RA-E
Heater control relay	PAM-4
Deluxe thermostat interface	RMF-CA100-V1
MNet adapter (BacNet/LonWorks BAS sub interface)	PAC-SJ95MA-E

Indoor Unit Outline and Dimensions:

Unit: inch (mm)

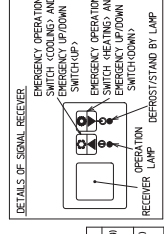
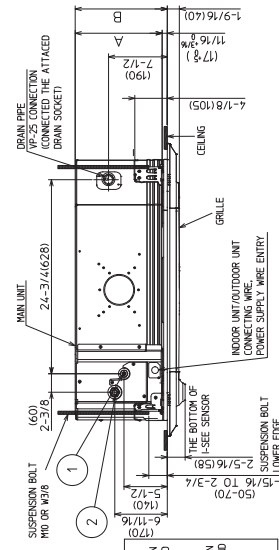
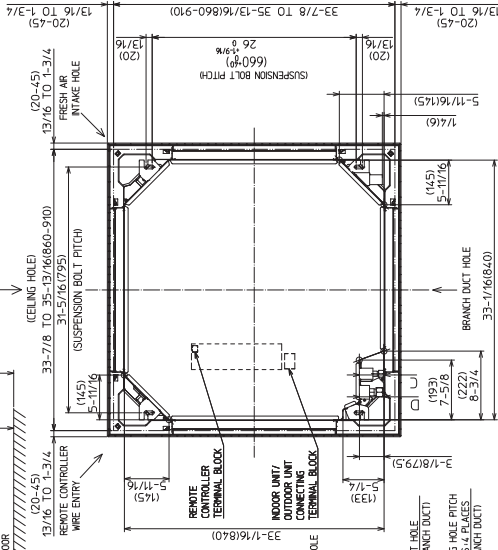
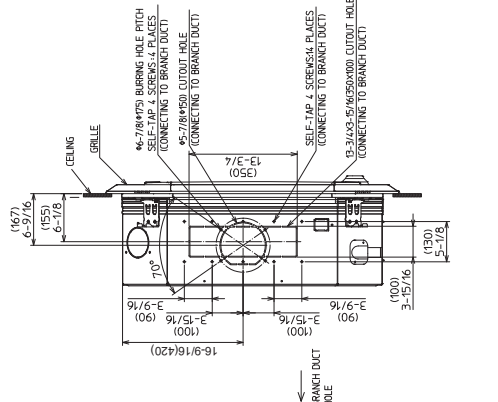
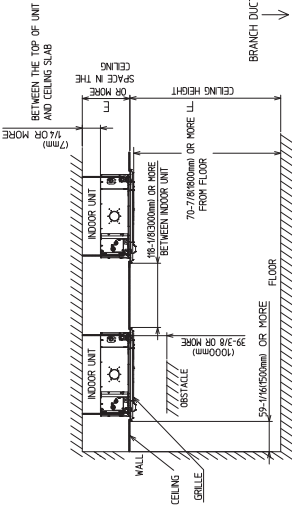
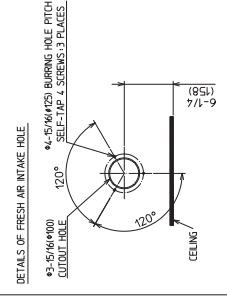

NOTE: CHOOSE THE GRILLE AMONG THE DESIGNATED GRILLES.
 2. REINFORCE THE SUSPENSION BOLT FOR EARTHQUAKE-RESISTANCE AS NEEDED.
 3. FOR THE SUSPENSION BOLT, USE M10 OR M8.
 4. FOR DRAIN PIPE, USE VP-25 (100, Ø1-1/2/39.3) PVC TUBE.
 5. DRINK PUMP INCLUSION.
 6. MAKE SURE TO SAUCE THE ELECTRICAL WIRE LITTLE BIT FOR CONTINGENT WIRE CONNECTION.
 7. CHECK THE WIRE CONNECTIONS AND MAKE SURE THE UNIT IS ABLE TO BE ADJUSTED WITH THE GRILLE ATTACHED.
 8. PROVIDE 2" OR MORE SPACE BETWEEN TRANSOM AND CEILING FOR THE INSTALLATION.
 9. IT BECOMES THE CAUSE OF DRIPLET OR DRIPLET DIPPING. BE CAREFUL TO CHECK THE PARTY INSTALLATION SERVICE SPACE. PLEASE REFER TO THE SAFETY PRECAUTIONS.
 10. FOR THE INSTALLATION OF THE OPTIONAL HIGH EFFICIENCY FILTER OR MULTI-FUNCTIONAL CASSETTE, REFER TO SPECIAL DRAWING.

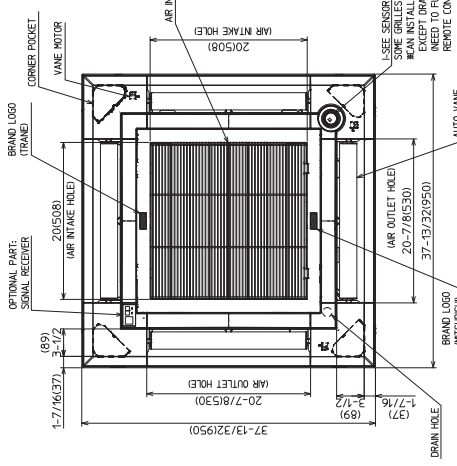

MODELS	①	②	A	B	C	D	E	F
PLA-A24EA7R1-TH	REFRIGERANT PRE-A27 FLORED CONNECTION TUF	9-1/2	10-3/16	10-7/16(267)	13-1/8	3-7/8	DR MORE	DR LESS
PLA-A24EA7R1-TH	REFRIGERANT PRE-A27 FLAT CONNECTION 3/8"	11-1/8	11-3/4	11-3/4	11-3/4	11-3/4	DR MORE	DR LESS

Outdoor Unit Outline and Dimensions:

Unit: mm<in>

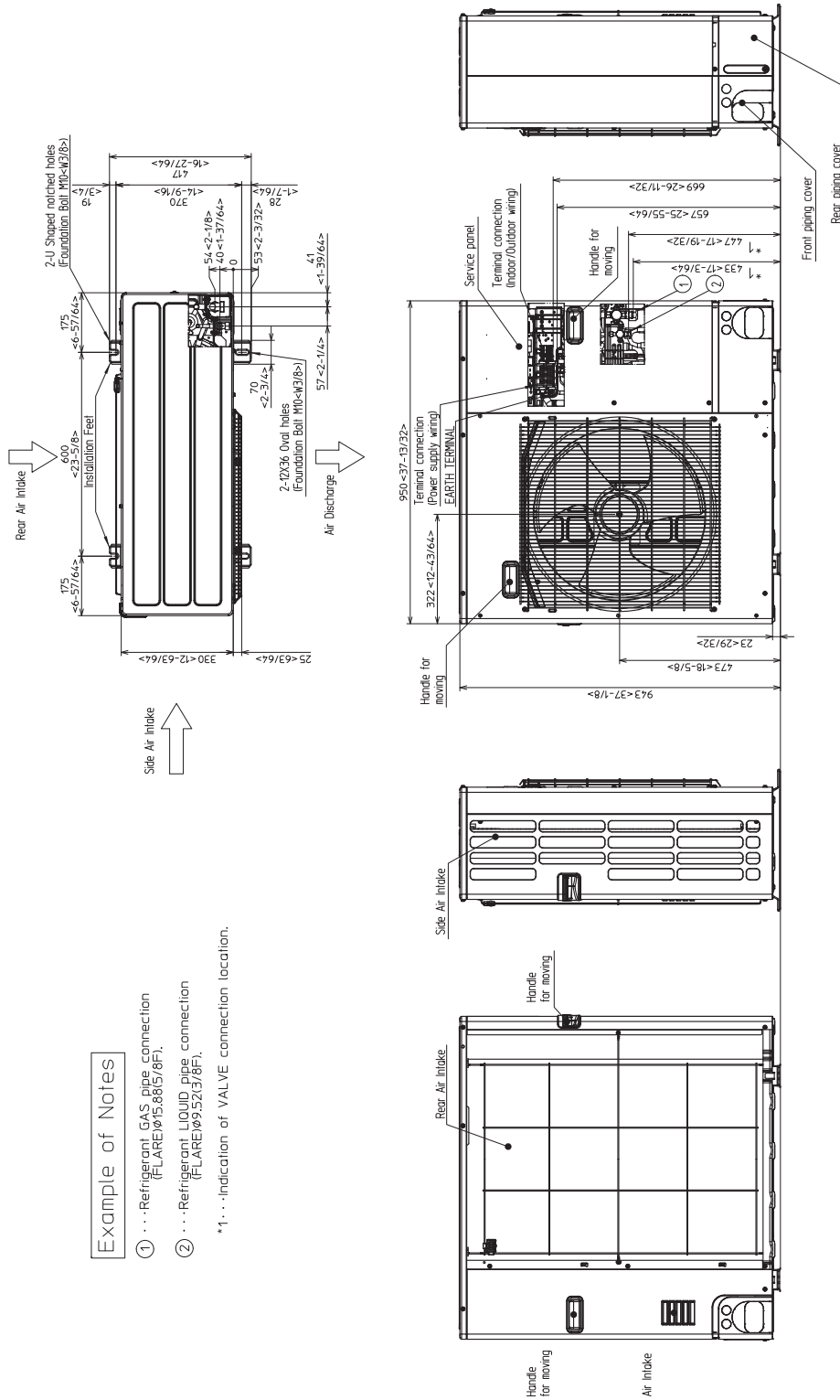

Example of Notes

- ① ... Refrigerant GAS pipe connection (FLARE)φ15.88(5/8F).
- ② ... Refrigerant LIQUID pipe connection (FLARE)φ9.52(3/8F).

*1... Indication of VALVE connection location.

