

**Revision D:**

- Some descriptions have been modified.

Please void OBH497 REVISED EDITION-C.

## INDOOR UNIT

# SERVICE MANUAL

**No. OBH497**  
REVISED EDITION-D

### Models

**MSZ-FD09NA**  
**MSZ-FD12NA**

Outdoor unit service manual  
MUZ-FD•NA Series (OBH498)  
MXZ-A•NA Series (OB444)

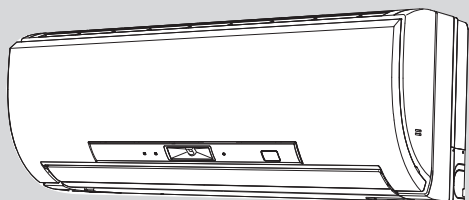

### CONTENTS

1. TECHNICAL CHANGES.....	3
2. PART NAMES AND FUNCTIONS.....	4
3. SPECIFICATION.....	5
4. OUTLINES AND DIMENSIONS .....	7
5. WIRING DIAGRAM.....	8
6. REFRIGERANT SYSTEM DIAGRAM .....	9
7. SERVICE FUNCTIONS .....	10
8. MICROPROCESSOR CONTROL .....	12
9. TROUBLESHOOTING.....	22
10. DISASSEMBLY INSTRUCTIONS.....	36

**PARTS CATALOG (OBB497)**

**NOTE:**  
RoHS compliant products have <G> mark on the spec name plate.

**Mr. SLIM™**

**Revision A:**

- 3. SPECIFICATION has been corrected.

**Revision B:**

- 3. SPECIFICATION has been corrected.

**Revision C:**

- 3. SPECIFICATION has been corrected.

**Revision D:**

- Some descriptions have been modified.  
(
  - The description of the indirect airflow function has been deleted.
  - The description of "Dimensions" at "3. SPECIFICATION" has been corrected.)

**MSZ-FD09NA**

**MSZ-FD12NA**

1. New model

## 2

# PART NAMES AND FUNCTIONS

MSZ-FD09NA MSZ-FD12NA

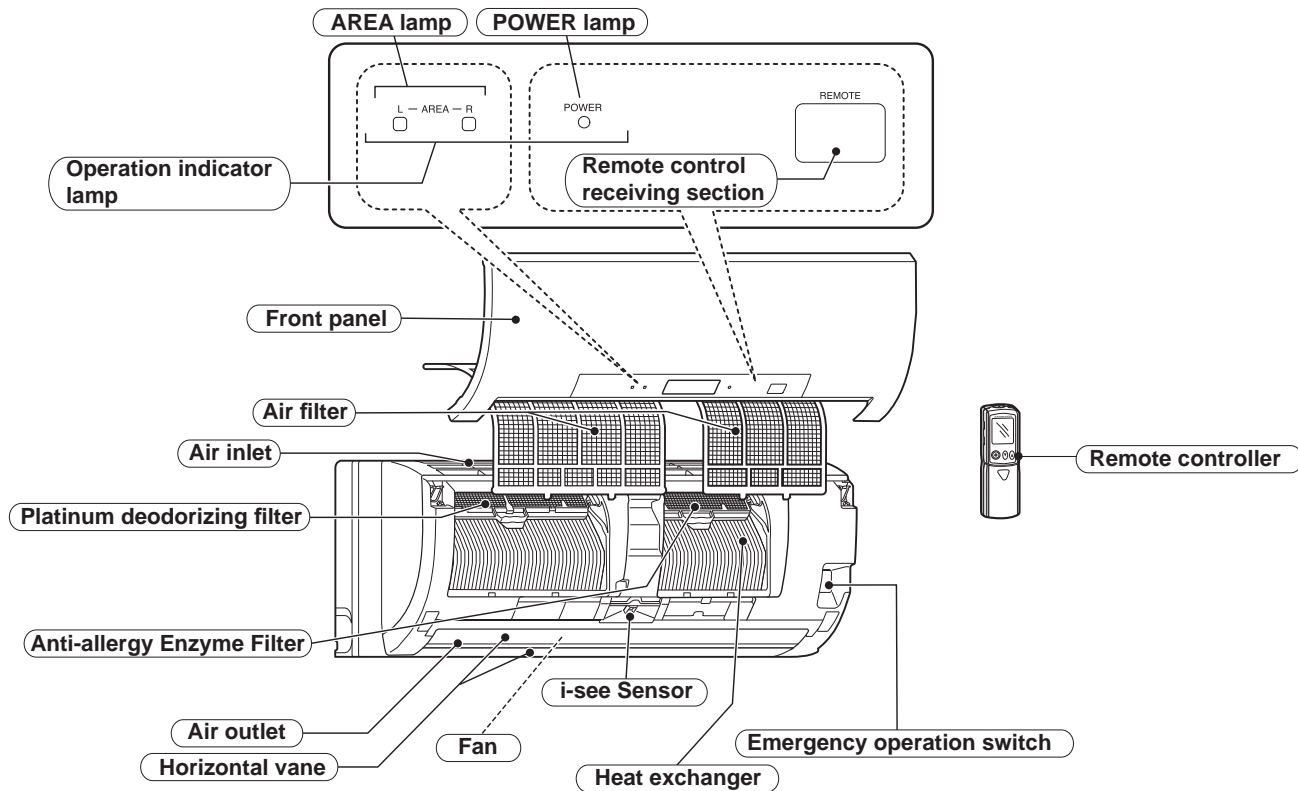

**AREA lamp indicates AREA setting**  
In AREA setting, the horizontal air flow direction changes automatically according to the detection of i-see Sensor which detects the floor/wall temperature to air-condition the room evenly.

**i-see control operation**  
i-see Sensor constantly measure floor/wall temperature to automatically adjust to the set temperature by estimating the temperature actually perceived by a person inside the room ("sensible temperature").

## ACCESSORIES

①	Installation plate	1
②	Installation plate fixing screw 4 × 25 mm	5
③	Remote controller holder	1
④	Fixing screw for ③ 3.5 × 1.6 mm (Black)	2
⑤	Battery (AAA) for remote controller	2
⑥	Wireless remote controller	1
⑦	Felt tape (Used for left or left-rear piping)	1

# 3

# SPECIFICATION

Indoor model			MSZ-FD09NA	MSZ-FD12NA
Power supply	V, phase, Hz		208/230 , 1 , 60	
Max. fuse size (time delay)/ Disconnect switch	A		15	
Min. circuit ampacity	A		1.0	
Fan motor	F.L.A		0.76	
Airflow Low - Med. - High - Powerful	COOL Dry (Wet)	CFM	162 - 226 - 339 - 381 (144 - 202 - 307 - 343)	162 - 226 - 381 - 410 (144 - 202 - 350 - 367)
	HEAT Dry	CFM	166 - 240 - 367 - 381	166 - 240 - 399 - 420
Moisture removal	pt./h		2.1	2.9
Sound level Low - Med. - High - Powerful	Cooling	dB(A)	22 - 31 - 39 - 42	22 - 33 - 43 - 45
	Heating	dB(A)	22 - 31 - 40 - 42	22 - 33 - 43 - 44
Cond. drain connection O.D.	in.		5/8	
Dimensions	W	in.	31-3/8	
	D		10-1/8	
	H		11-5/8	
Weight	lb.		27	
External finish	Munsell 1.0Y 9.2/0.2			
Remote controller	Wireless type			
Control voltage (by built-in transformer)	12 - 24 VDC			

**NOTE:** Test conditions are based on ARI 210/240.

### 3-1. OPERATING RANGE

#### (1) POWER SUPPLY

	Rated voltage	Guaranteed voltage (V)
Indoor unit	208/230 V 1 phase 60 Hz	

#### (2) OPERATION

Mode	Condition	Intake air temperature (°F)			
		Indoor		Outdoor	
		DB	WB	DB	WB
Cooling	Standard temperature	80	67	95	—
	Maximum temperature	90	73	115	—
	Minimum temperature	67	57	14	—
	Maximum humidity	78%		—	
Heating	Standard temperature	70	60	47	43
	Maximum temperature	80	67	75	65
	Minimum temperature	70	60	15 (- $\frac{5}{U}$ model)	14 (- $\frac{4}{U}$ model)

### 3-2. OUTLET AIR SPEED AND COVERAGE

Model	Mode	Function	Airflow (CFM)	Air speed (ft./sec.)	Coverage (ft.)
MSZ-FD09NA	HEAT	Dry	381	19.2	27.7
	COOL	Dry	339	17.1	24.7
		Wet	307	15.5	22.4
MSZ-FD12NA	HEAT	Dry	420	21.2	30.4
	COOL	Dry	381	19.2	27.7
		Wet	350	17.6	25.4

- The air coverage is the figure up to the position where the air speed is 1 ft./sec., when air is blown out horizontally from the unit properly at the High speed position.  
The coverage should be used only as a general guideline since it varies according to the size of the room and furniture arranged inside the room.

# 4

# OUTLINES AND DIMENSIONS

MSZ-FD09NA MSZ-FD12NA

Unit: inch

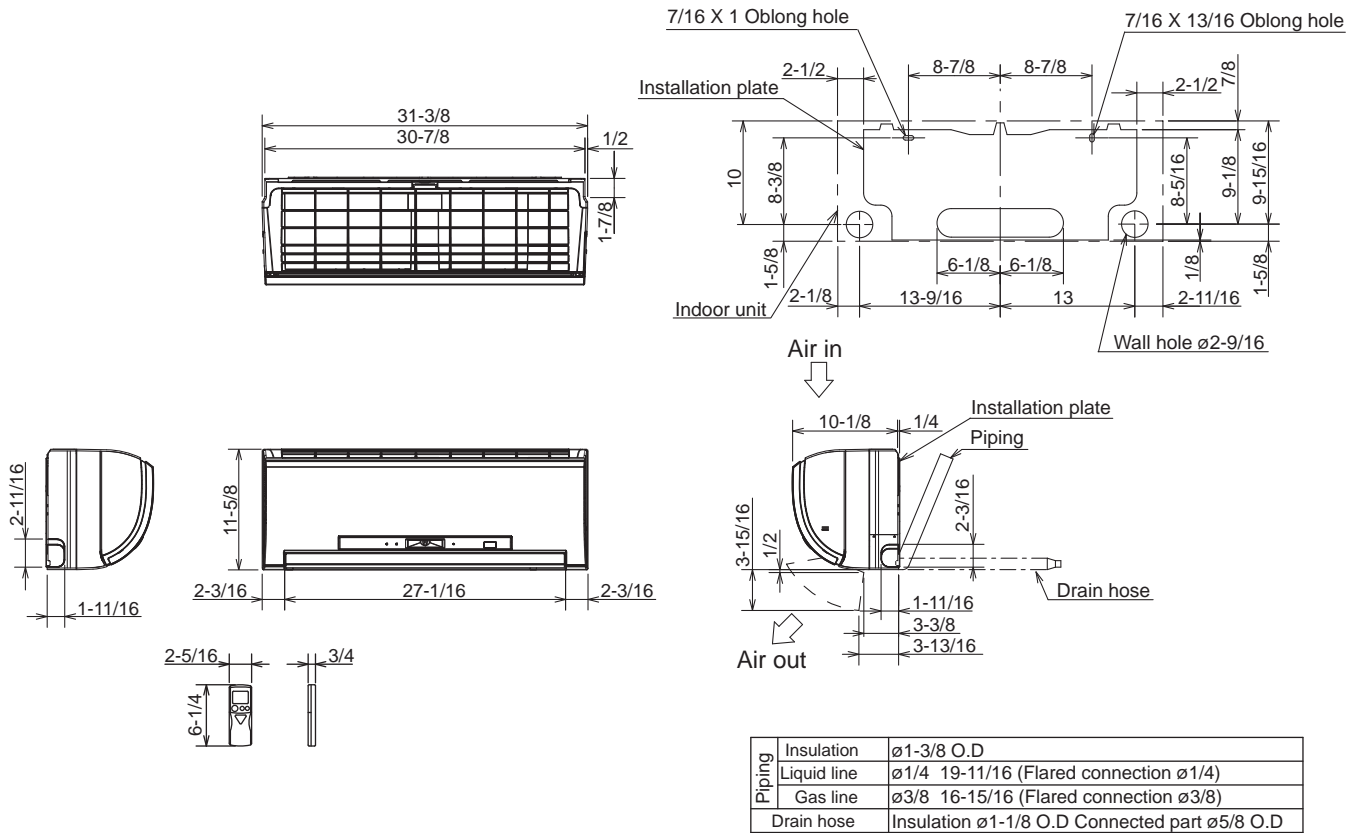

# 5

# WIRING DIAGRAM

## MSZ-FD09NA MSZ-FD12NA

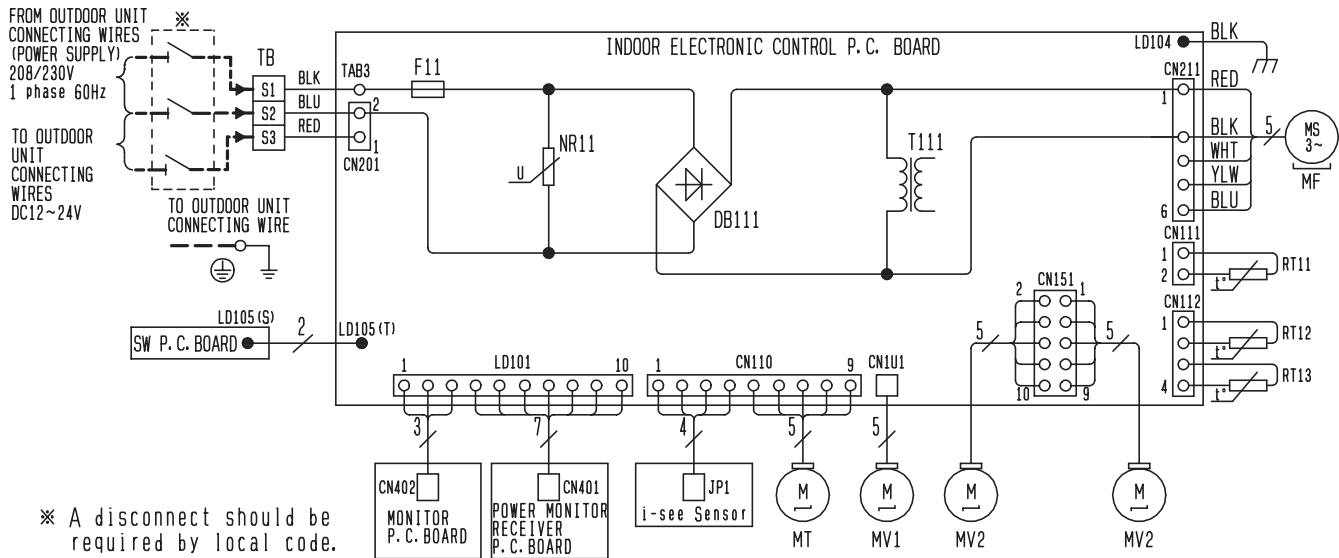

SYMBOL	NAME	SYMBOL	NAME
DB111	DIODE STACK	NR11	VARISTOR
F11	FUSE (T3. 15AL250V)	RT11	ROOM TEMP. THERMISTOR
MF	FAN MOTOR	RT12	COIL TEMP. THERMISTOR (MAIN)
MT	i-see Sensor MOTOR	RT13	COIL TEMP. THERMISTOR (SUB)
MV1	VANE MOTOR (HORIZONTAL)	T111	TRANSFORMER
MV2	VANE MOTOR (VERTICAL)	TB	TERMINAL BLOCK

- NOTES: 1. About the outdoor side electric wiring refer to the outdoor unit electric wiring diagram for servicing.
2. Use copper conductors only. (For field wiring)
3. Symbols below indicate.
- : Terminal block
- ⊞ : Connector



MSZ-FD09NA MSZ-FD12NA

Unit:inch

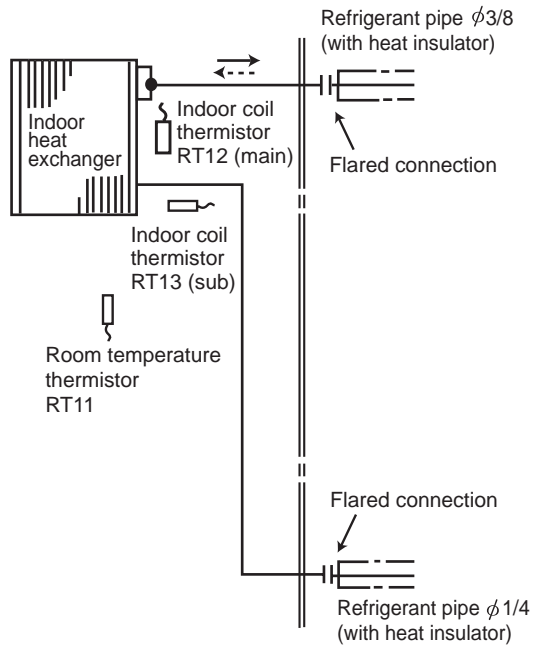

—————> Refrigerant flow in cooling  
 - - - - -> Refrigerant flow in heating

## MSZ-FD09NA MSZ-FD12NA

### 7-1. TIMER SHORT MODE

For service, set time can be shortened by short circuit of JPG and JPS the indoor electronic control P.C. board.

The time will be shortened as follows. (Refer to 9-7.)

Set time: 1-minute → 1-second

Set time: 3-minute → 3-second (It takes 3 minutes for the compressor to start operation. However, the starting time is shortened by short circuit of JPG and JPS.)

### 7-2. P.C. BOARD MODIFICATION FOR INDIVIDUAL OPERATION

A maximum of 4 indoor units with wireless remote controllers can be used in a room.

In this case, to operate each indoor unit individually by each remote controller, P.C. boards of remote controller must be modified according to the number of the indoor unit.

#### How to modify the remote controller P.C. board

Remove batteries before modification.

The board has a print as shown below:

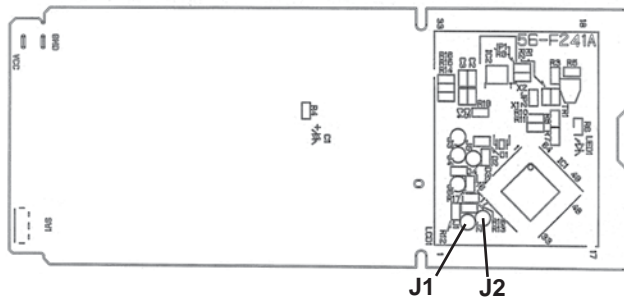

**NOTE:** For modification, take out the batteries and press the OPERATE/STOP (ON/OFF) button twice or 3 times at first.

After finish modification, put back the batteries then press the RESET button.

The P.C. board has the print "J1" and "J2". Solder "J1" and "J2" according to the number of indoor unit as shown in Table 1. After modification, press the RESET button.

**Table 1**

	1 unit operation	2 units operation	3 units operation	4 units operation
No. 1 unit	No modification	Same as at left	Same as at left	Same as at left
No. 2 unit	—	Solder J1	Same as at left	Same as at left
No. 3 unit	—	—	Solder J2	Same as at left
No. 4 unit	—	—	—	Solder both J1 and J2

#### How to set the remote controller exclusively for particular indoor unit

After you turn the breaker ON, the first remote controller that sends the signal to the indoor unit will be regarded as the remote controller for the indoor unit.

The indoor unit will only accept the signal from the remote controller that has been assigned to the indoor unit once they are set.

The setting will be cancelled if the breaker has turned OFF, or the power supply has shut down.

Please conduct the above setting once again after the power has restored.

### 7-3. AUTO RESTART FUNCTION

When the indoor unit is controlled with the remote controller, the operation mode, the set temperature, and the fan speed are memorized by the indoor electronic control P.C. board. "AUTO RESTART FUNCTION" automatically starts operation in the same mode just before the shutoff of the main power.

#### Operation

- ① If the main power has been cut, the operation settings remain.
- ② After the power is restored, the unit restarts automatically according to the memory.  
(However, it takes at least 3 minutes for the compressor to start running.)

#### How to release "AUTO RESTART FUNCTION"

- ① Turn off the main power of the unit.
- ② Solder the Jumper wire JR07 on the indoor electronic control P.C. board. (Refer to 9-7.)

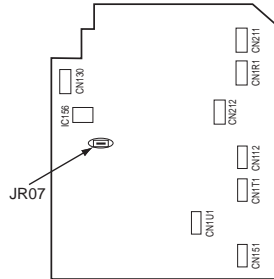

#### NOTE:

- The operation settings are memorized when 10 seconds have passed after the indoor unit was operated with the remote controller.
- If main power is turned OFF or a power failure occurs while AUTO START/STOP timer is active, the timer setting is cancelled.
- If the unit has been off with the remote controller before power failure, the auto restart function does not work as the power button of the remote controller is OFF.
- To prevent breaker OFF due to the rush of starting current, systematize other home appliance not to turn ON at the same time.
- When some air conditioners are connected to the same supply system, if they are operated before power failure, the starting current of all the compressors may flow simultaneously at restart. Therefore, the special counter-measures are required to prevent the main voltage-drop or the rush of the starting current by adding to the system that allows the units to start one by one.

### 7-4. REMOTE CONTROLLER

Be sure to set the slide switch inside the remote controller to an appropriate position in accordance with the installed position of the indoor unit. If the switch is not set correctly, the air conditioner may not function properly.

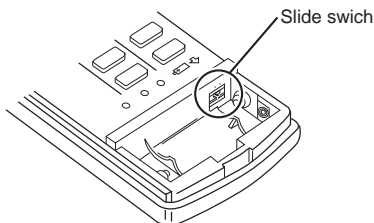

Area	Left	Center	Right
Position of the slide switch			
Display on the remote controller			

Where is the indoor unit installed in your room?

Installed at left, if the distance is not more than 19-3/4 inch (50 cm).

Installed at right, if the distance is not more than 19-3/4 inch (50 cm).

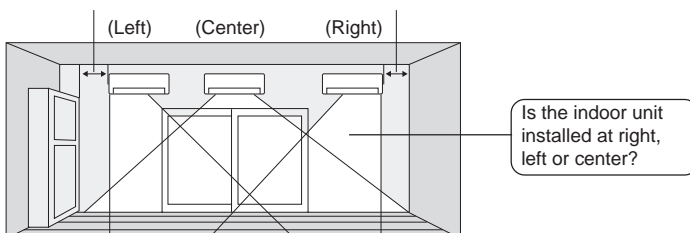

**NOTE:** If the indoor unit is installed more than 19-3/4 inch (50 cm) away from the side walls, cabinets or other nearby objects, set the slide switch to the "center" position.

MSZ-FD09NA MSZ-FD12NA

## WIRELESS REMOTE CONTROLLER

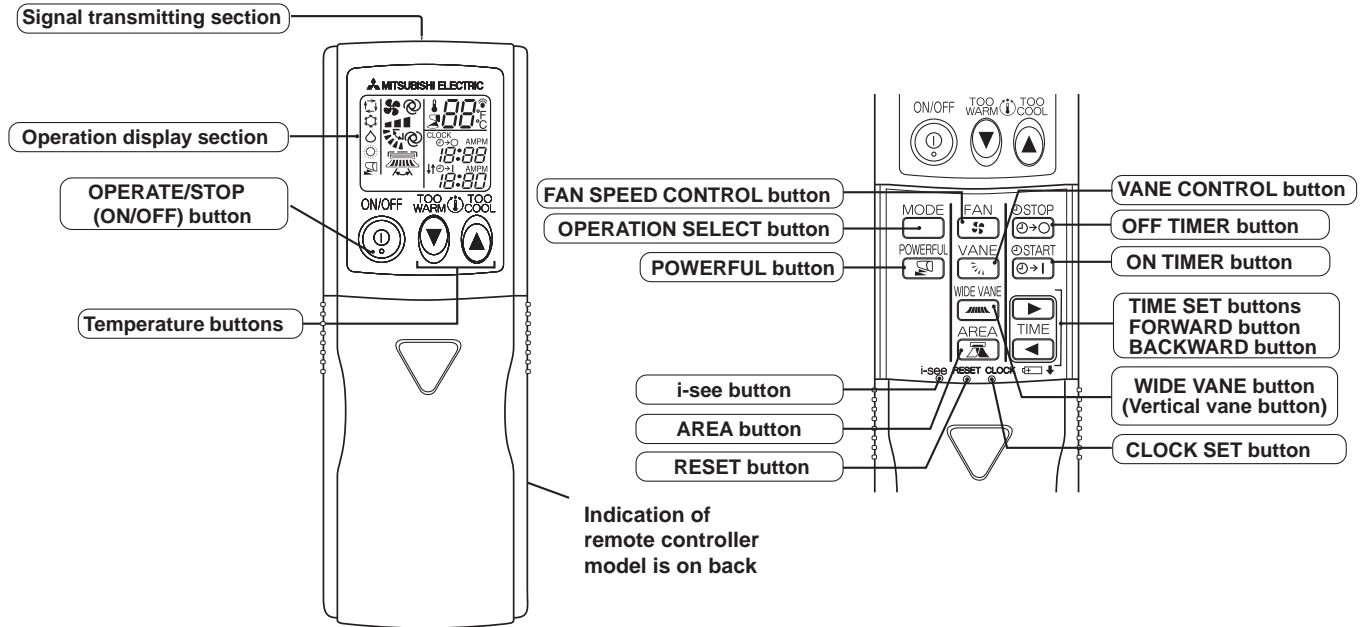

**NOTE:** Last setting will be stored after the unit is turned OFF with the remote controller. Indoor unit receives the signal of the remote controller with beeps.

## INDOOR UNIT LAMP

The lamps at the center of the indoor unit indicates the operation state.

Lamp	Operation state
AREA	Refer to 8-7.
POWER	Lamp lights during operation. Lamp blinks in abnormal condition.

## 8-1. COOL ( ❄ ) OPERATION

- (1) Press OPERATE/STOP (ON/OFF) button.  
POWER lamp of the indoor unit turns on with a beep tone.
- (2) Select COOL mode with OPERATION SELECT button.
- (3) Press TEMPERATURE buttons (TOO WARM or TOO COOL button) to select the desired temperature.  
The setting range is 61 ~ 88°F (16 ~ 31°C).

### 1. Coil frost prevention

The compressor operational frequency is controlled by the temperature of the indoor heat exchanger to prevent the coil from frosting.

When the temperature of indoor heat exchanger becomes too low, the coil frost prevention mode works.

The indoor fan operates at the set speed and the compressor stops. This mode continues until the temperature of indoor heat exchanger rises.

### 2. Low outside temperature operation

When the outside temperature is lower, low outside temperature operation starts, and the outdoor fan slows or stops.

## 8-2. DRY ( ☀ ) OPERATION

- (1) Press OPERATE/STOP (ON/OFF) button.  
POWER lamp of the indoor unit turns on with a beep tone.
- (2) Select DRY mode with OPERATION SELECT button.
- (3) The set temperature is determined from the initial room temperature.

### 1. Coil frost prevention

Coil frost prevention is as same as COOL mode. (8-1.1.)

### 2. Low outside temperature operation

Low outside temperature operation is as same as COOL mode. (8-1.2.)

## 8-3. HEAT ( 🔥 ) OPERATION

- (1) Press OPERATE/STOP (ON/OFF) button.  
POWER lamp of the indoor unit turns on with a beep tone.
- (2) Select HEAT mode with OPERATION SELECT button.
- (3) Press TEMPERATURE buttons (TOO WARM or TOO COOL button) to select the desired temperature.  
The setting range is 61 ~ 88°F (16 ~ 31°C).

### 1. Cold air prevention control

When the compressor is not operating or is starting, and the temperature of indoor heat exchanger and/or the room temperature is low or when defrosting is being done, the indoor fan will stop or rotate in Very Low speed.

### 2. High pressure protection

The compressor operational frequency is controlled by the temperature of the indoor heat exchanger to prevent the condensing pressure from increasing excessively.

When the temperature of indoor heat exchanger becomes too high, the high pressure protection works.

The indoor fan operates following the cold air prevention control. This mode continues until the temperature of indoor heat exchanger falls.

### 3. Defrosting

Defrosting starts when the temperature of outdoor heat exchanger becomes too low.

The compressor stops once, the indoor/outdoor fans stop, the 4-way valve reverses and the compressor re-starts.

This mode continues until the temperature of outdoor heat exchanger rises or the fixed time passes.

## 8-4. AUTO CHANGE OVER ... AUTO MODE OPERATION

Once desired temperature is set, unit operation is switched automatically between COOL and HEAT operation.

### Mode selection

#### (1) Initial mode

When unit starts the operation with AUTO operation from off:

- If the room temperature is higher than the set temperature, operation starts in COOL mode.
- If the room temperature is equal to or lower than the set temperature, operation starts in HEAT mode.

#### (2) Mode change

COOL mode changes to HEAT mode when about 15 minutes have passed with the room temperature 4°F (2°C) below the set temperature.

HEAT mode changes to COOL mode when about 15 minutes have passed with the room temperature 4°F (2°C) above the set temperature.

### NOTE1

If two or more indoor units are operating in multi system, there might be a case that the indoor unit, which is operating in □ (AUTO), cannot change over to the other operating mode (COOL ↔ HEAT) and becomes a state of standby.

Refer to **NOTE 2 "FOR MULTI SYSTEM AIR CONDITIONER"**.

### NOTE 2

#### FOR MULTI SYSTEM AIR CONDITIONER

##### OUTDOOR UNIT: MXZ series

Multi system air conditioner can connect two or more indoor units with one outdoor unit.

- When you try to operate two or more indoor units with one outdoor unit simultaneously, one for the cooling and the others for heating, the operation mode of the indoor unit that operates earlier is selected. Other indoor units cannot operate, and operation indicator lamp flashes as shown in the figure below. In this case, please set all the indoor units to the same operation mode.

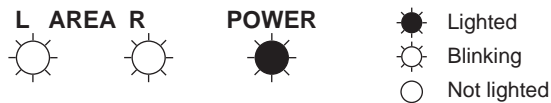

- When indoor unit starts the operation while the defrosting of outdoor unit is being done, it takes a few minutes (max. 10 minutes) to blow out the warm air.
- In the heating operation, though indoor unit that does not operate may get warm or the sound of refrigerant flowing may be heard, they are not malfunction. The reason is that the refrigerant continuously flows into it.

## 8-5. AUTO VANE OPERATION

### 1. Horizontal vane

#### (1) Vane motor drive

These models are equipped with a stepping motor for the horizontal vane. The rotating direction, speed, and angle of the motor are controlled by pulse signals (approx. 12 V) transmitted from indoor microprocessor.

#### (2) The horizontal vane angle and mode change as follows by pressing VANE CONTROL button.

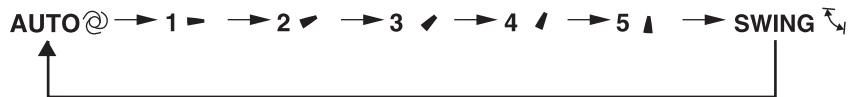

(3) Positioning

To confirm the standard position, the vane moves until it touches the vane stopper. Then the vane is set to the selected angle.

Confirming of standard position is performed in the following cases:

- (a) The operation starts or finishes (including timer operation).
- (b) The test run operation starts.
- (c) Standby mode (only during multi system operation) starts or finishes.

(4) VANE AUTO ( @ ) mode

The microprocessor automatically determines the vane angle to make the optimum room temperature distribution.

COOL and DRY operation  
Vane angle is fixed to Angle 1.

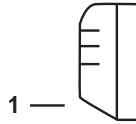

HEAT operation  
Vane angle is fixed to Angle 4.

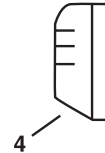

(5) STOP (operation OFF) and ON TIMER standby

In the following cases, the horizontal vane returns to the closed position.

- (a) OPERATE/STOP (ON/OFF) button is pressed (POWER OFF).
- (b) The operation is stopped by the emergency operation.
- (c) ON TIMER is ON standby.

(6) Dew prevention

During COOL or DRY operation with the vane angle at Angle 3 ~ 5 when the compressor cumulative operation time exceeds 1 hour or 30 minutes, the vane angle automatically changes to Angle 2 for dew prevention.

(7) SWING ( Ɔ ) mode

By selecting SWING mode with VANE CONTROL button, the horizontal vane swings vertically.

(8) Cold air prevention in HEAT operation

The horizontal vane position is set to Upward.

**NOTE:** When 2 or more indoor units are operated with multi outdoor unit, even if any indoor unit turns thermostat off, this control doesn't work in the indoor unit.

(9) POWERFUL ( Ɔ ) operation.

The air conditioner automatically adjusts the fan speed and the set temperature, and operates the POWERFUL mode. The POWERFUL mode is automatically released 15 minutes after operation starts, and the operation mode returns to the mode prior to POWERFUL operation

## 2. Vertical vane

### (1) Vane motor drive

These models are equipped with a stepping motor for the vertical vane. The rotating direction, speed, and angle of the motor are controlled by pulse signals (approx. 12 V) transmitted from microprocessor.

### (2) The vertical vane angle and mode change as follows by pressing WIDE VANE button.

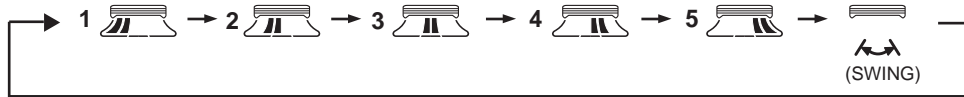

### (3) Positioning

The vane presses the vane stopper once to confirm the standard position and then set to the desired angle. Confirming of standard position is performed in the following cases.

- (a) OPERATE/STOP (ON/OFF) button is pressed (POWER ON).
- (b) SWING is started.

### (4) SWING MODE (↔)

By selecting SWING mode with WIDE VANE button, the vertical vane swings horizontally.

The remote controller displays "↔". Swing mode is cancelled when WIDE MODE button is pressed once again.



## 8-6. i-see CONTROL OPERATION

The sensors constantly measure the room and floor/wall temperatures to automatically adjust to the set temperature by estimating the temperature actually perceived by a person inside the room ("sensory temperature").

### Advantages

- The air inside the room is conditioned quickly to a comfortable condition.
- The room will not become too cold or hot even when the air conditioner is kept on for a long period.
- The air conditioner will not overcool or overheat, which means you can save on electricity.

i-see control operation is activated when i-see button is pressed with a thin stick in manual COOL or manual HEAT mode.

**NOTE:** i-see control operation is activated when the remote controller is first used following replacement of the batteries or resetting of the remote controller.

i-see control operation is cancelled when i-see button is pressed with a thin stick once again.

**NOTE:** If the conditioner is turned OFF without cancelling i-see control operation, i-see control operation is activated the next time the air conditioner is turned ON.

### i-see Sensor

i-see Sensor, which is installed on the upper of the air outlet of the indoor unit, is moved with the stepping motor and it detects the floor/wall temperature.



### i-see Sensor

- When AREA setting is not activated, the sensing range of i-see Sensor differs depending on the installation location of the air conditioner.

Installation position	Installed at left	Installed at center	Installed at right
Image of sensing range			
Direction of sensor	Right	Center	Left



Refer to "Remote controller in SERVICE FUNCTIONS".

- Install the front panel correctly after being removed for maintenance or service so that the floor/wall temperatures can be measured correctly.

## 8-7. AREA ( ) SETTING

- (1) Press OPERATE/STOP (ON/OFF) button to start the air conditioner.
- (2) Press i-see button. (**NOTE1**)
- (3) Press AREA button.

Each time the button is pressed, the area is changed in sequence:

 (AUTO) →  (LEFT) →  (RIGHT) → Cancel

i-see Sensor moves intermittently, measuring the floor and wall temperature.

- (4) AREA setting is cancelled when the "cancel" is selected by pressing AREA button, or when WIDE VANE button is pressed.

**NOTE1:** AREA setting is only available during i-see control operation.

**NOTE2:** If AREA setting is cancelled, the vertical vane returns to the previously set position before AREA setting.

**NOTE3:** The horizontal air flow direction (WIDE VANE button), including horizontal SWING, cannot be set during AREA setting

●Indoor unit installation location and air-conditioning area

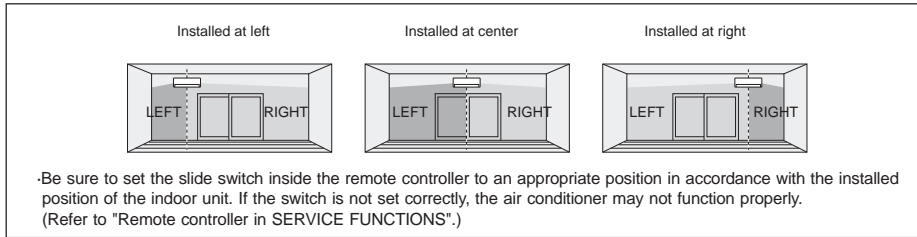

	To air-condition mainly the left area of the room	To air-condition the entire room The horizontal air flow direction and indoor unit display are switched according to the room temperature (floor/wall).	To air-condition mainly the right area of the room
Remote controller button	Press AREA button to select LEFT.	Press AREA button to select AUTO.	Press AREA button to select RIGHT.
Remote controller display			
i-see Sensor operation			
Control range of horizontal air flow direction. The vertical air flow direction conforms to the setting on the remote controller. (The horizontal air flow direction is controlled in this range.)	Installed at center 		
	Installed at left 		
	Installed at right 		
Indoor unit display	AREA L  R	L  R  or L  R  or L  R	L  R

Lighted  
 Not lighted

●When AREA is set to AUTO

- The vertical vane is controlled to maintain uniform temperature in the whole room.
- The i-see Sensor moves in a range of 150 degrees detecting floor/wall temperature of 3 areas (left, right, center). Therefore, the detected temperatures may be different from the temperatures measured on commercial thermometers depending on the condition or temperature distribution on the floor and/or wall.

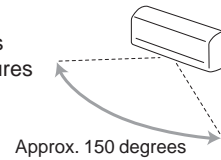

Ex.) In COOL mode

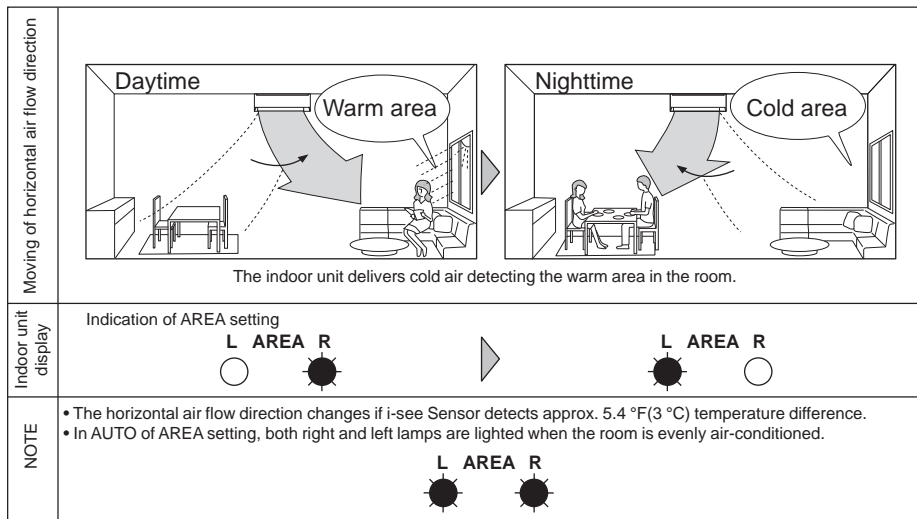

Lighted  
 Not lighted

### Operation and operating range

i-see sensor moves 30 degrees from the center in both right and left side.

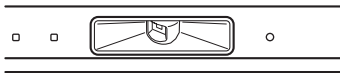

i-see Sensor turning to the left

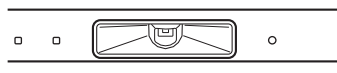

i-see Sensor turning to the center

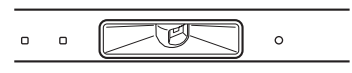

i-see Sensor turning to the right

i-see Sensor operates as follows in accordance with AREA setting made with the remote controller.

“AUTO” in AREA setting: first turning to the LEFT for adjusting the position then .....

CENTER → RIGHT → CENTER → LEFT → CENTER .....

(The sensor turns to the right, left and center.)

“RIGHT” in AREA setting: first turning to the LEFT for adjusting the position then .....

CENTER → RIGHT → CENTER → RIGHT → CENTER .....

(The sensor turns to the right and center.)

“LEFT” in AREA setting: first turning to the LEFT for adjusting the position then .....

CENTER → LEFT → CENTER → LEFT → CENTER .....

(The sensor turns to the left and center.)

The sensor finishes turning to one area to another for 3 seconds and it operates one area for 5 seconds.

## 8-8. TIMER OPERATION

### 1. How to set the time



(1) Check that the current time is set correctly.

**NOTE:** Timer operation will not work without setting the current time. Initially "0:00 AM" blinks at the current time display of TIME MONITOR, so set the current time correctly with CLOCK SET button.

#### How to set the current time

(a) Press the CLOCK set button.

(b) Press the TIME SET buttons (  and  ) to set the current time.

- Each time FORWARD button (  ) is pressed, the set time increases by 1 minute, and each time BACKWARD button (  ) is pressed, the set time decreases by 1 minute.
- Pressing those buttons longer, the set time increases/decreases by 10 minutes.

(c) Press the CLOCK set button.

(2) Press OPERATE/STOP (ON/OFF) button to start the air conditioner.

(3) Set the time of timer.

#### ON timer setting



(a) Press ON TIMER button (  ) during operation.

(b) Set the time of the timer using TIME SET buttons (  and  ). \*

#### OFF timer setting

(a) Press OFF TIMER button (  ) during operation.

(b) Set the time of the timer using TIME SET buttons (  and  ). \*

\* Each time FORWARD button (  ) is pressed, the set time increases by 10 minutes: each time BACKWARD button (  ) is pressed, the set time decreases by 10 minutes.

### 2. To release the timer

To release ON timer, press ON TIMER button (  ).

To release OFF timer, press OFF TIMER button (  ).

TIMER is cancelled and the display of set time disappears.

## PROGRAM TIMER

- OFF timer and ON timer can be used in combination. The timer of the set time that is reached first will operate first.
- "↓" and "↑" display shows the order of OFF timer and ON timer operation.

(Example 1) The current time is 8:00 PM.

The unit turns off at 11:00 PM, and on at 6:00 AM.

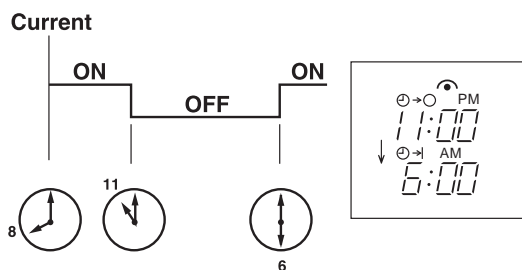

(Example 2) The current time is 11:00 AM.

The unit turns on at 5:00 PM, and off at 9:00 PM.

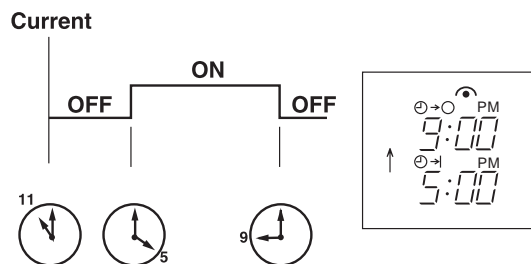

**NOTE:** If the main power is turned OFF or a power failure occurs while ON/OFF timer is active, the timer setting is cancelled. As these models are equipped with an auto restart function, the air conditioner starts operating with timer cancelled when power is restored.

## 8-9. EMERGENCY/TEST OPERATION

In case of test run operation or emergency operation, use EMERGENCY OPERATION switch on the right side of the indoor unit. Emergency operation is available when the remote controller is missing, has failed or the batteries of the remote controller run down. The unit will start and AREA lamp will light.

The first 30 minutes of operation is the test run operation. This operation is for servicing. The indoor fan runs at High speed and thermostat is ON, but temperature control does not work.

After 30 minutes of test run operation, the system shifts to EMERGENCY COOL/HEAT MODE with a set temperature of 75°F (24°C). The fan speed shifts to Med.

All protective operations such as the coil frost prevention works even in emergency operation.

In the test run or emergency operation, the horizontal vane operates in VANE AUTO (Ⓢ) mode.

Emergency operation continues until EMERGENCY OPERATION switch is pressed once or twice or the unit receives any signal from the remote controller. In case of latter, normal operation will start.

**NOTE:** Do not press EMERGENCY OPERATION switch during normal operation.

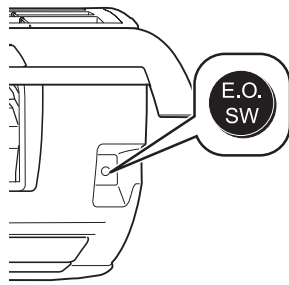

Operation mode	COOL	HEAT
Set temperature	75°F (24°C)	75°F (24°C)
Fan speed	Med.	Med.
Horizontal vane	Auto	Auto
Vertical vane	Straight	Straight

The operation mode is indicated by the AREA lamp as following

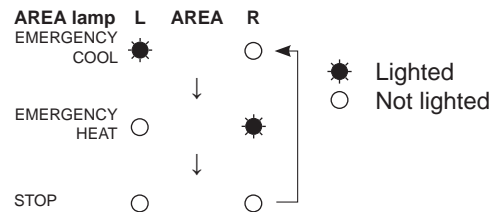

**NOTE:**  
This is the indication of EMERGENCY OPERATION mode.  
AREA setting is not available during EMERGENCY OPERATION.

## 8-10. 3-MINUTE TIME DELAY OPERATION

When the system turns OFF, compressor will not restart for 3 minutes as 3-minute time delay function operates to protect compressor from overload.

## 8-11. Changing temperature indication (°F/°C)

- The preset unit is °F.
- °F → °C: Press RESET button while the temperature buttons are pressed.
- °C → °F: Press RESET button or remove the batteries .

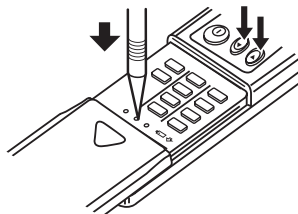

Press RESET button gently using a thin stick.

## MSZ-FD09NA MSZ-FD12NA

## 9-1. CAUTIONS ON TROUBLESHOOTING

## 1. Before troubleshooting, check the following

- 1) Check the power supply voltage.
- 2) Check the indoor/outdoor connecting wire for miswiring.

## 2. Take care of the following during servicing

- 1) Before servicing the air conditioner, be sure to turn off the unit first with the remote controller, and then after confirming the horizontal vane is closed, turn off the breaker and/or disconnect the power plug.
- 2) Be sure to turn OFF the power supply before removing the front panel, the cabinet, the top panel, and the P.C. board.
- 3) When removing the P.C. board, hold the edge of the board with care NOT to apply stress on the components.
- 4) When connecting or disconnecting the connectors, hold the housing of the connector. DO NOT pull the lead wires.

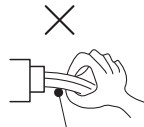

Lead wiring

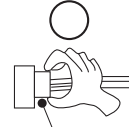

Housing point

## 3. Troubleshooting procedure

- 1) First, check if the OPERATION INDICATOR lamp on the indoor unit is flashing on and off to indicate an abnormality. To make sure, check how many times the abnormality indication is flashing on and off before starting service work.
- 2) Before servicing check that the connector and terminal are connected properly.
- 3) When the P.C. board seems to be defective, check the copper foil pattern for disconnection and the components for bursting and discoloration.
- 4) When troubleshooting, refer to 9-2., 9-3. and 9-4.

## 4. How to replace batteries

Weak batteries may cause the remote controller malfunction.

In this case, replace the batteries to operate the remote controller normally.

- ① Remove the front lid and insert batteries. Then reattach the front lid.

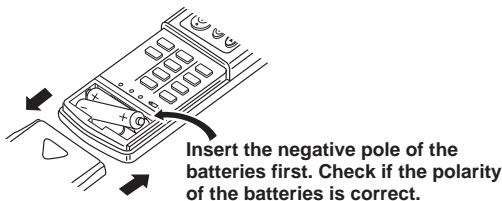

- ② Press RESET button with tip end of ball point pen or the like, and then use the remote controller.

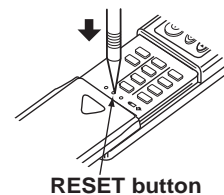

**NOTE:** 1. If RESET button is not pressed, the remote controller may not operate correctly.

2. This remote controller has a circuit to automatically reset the microcomputer when batteries are replaced. This function is equipped to prevent the microcomputer from malfunctioning due to the voltage drop caused by the battery replacement.

## 9-2. FAILURE MODE RECALL FUNCTION

Outline of the function

This air conditioner can memorize the abnormal condition which has occurred once.

Even though LED indication listed on the troubleshooting check table (9-4.) disappears, the memorized failure details can be recalled.

This mode is very useful when the unit needs to be repaired for the abnormality which does not recur.

### 1. Flow chart of failure mode recall function for the indoor/outdoor unit

Operational procedure

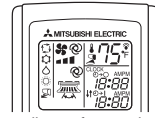
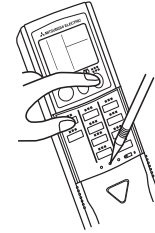
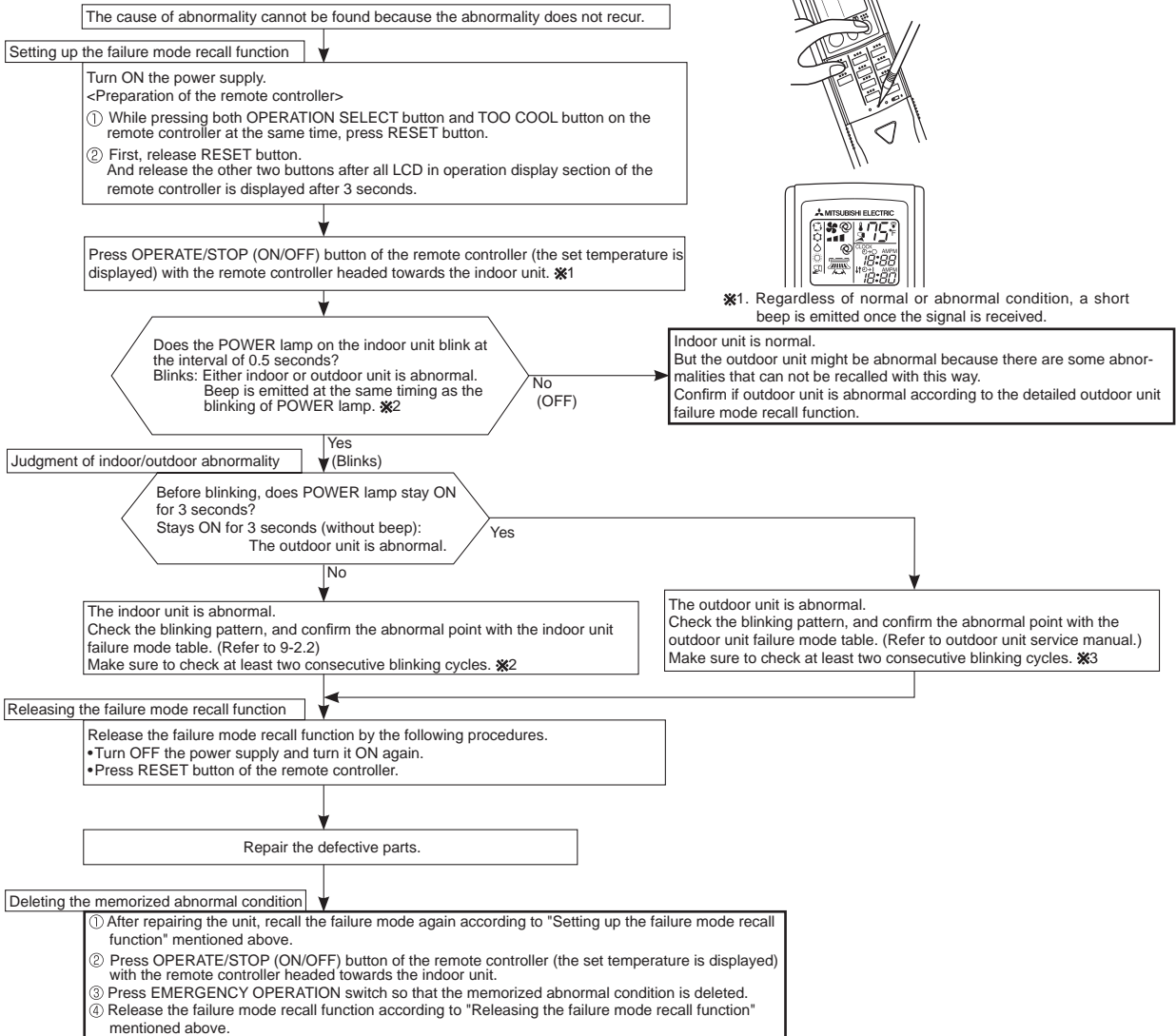

**NOTE:** 1. Make sure to release the failure mode recall function once it is set up, otherwise the unit cannot operate properly.  
 2. If the abnormal condition is not deleted from the memory, the last abnormal condition is kept memorized.

\*2. Blinking pattern when the indoor unit is abnormal:

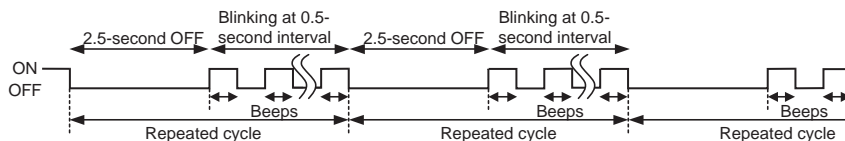

\*3. Blinking pattern when the outdoor unit is abnormal:

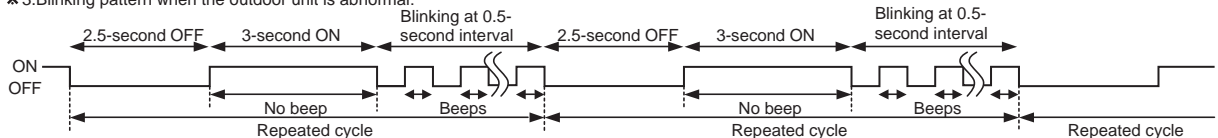



## 2. Indoor unit failure mode table

POWER	Abnormal point (Failure mode)	Condition	Correspondence
Not lighted	Normal	—	—
1-time flash every 0.5-second	Room temperature thermistor	The room temperature thermistor short or open circuit is detected every 8 seconds during operation.	Refer to the characteristics of the room temperature thermistor (9-7.).
2-time flash 2.5-second OFF	Indoor coil thermistor	The indoor coil thermistor short or open circuit is detected every 8 seconds during operation.	Refer to the characteristics of the main indoor coil thermistor, the sub indoor coil thermistor (9-7.).
3-time flash 2.5-second OFF	Serial signal	The serial signal from outdoor unit is not received for a maximum of 6 minutes.	Refer to 9-6.Ⓒ "How to check miswiring and serial signal error".
11-time flash 2.5-second OFF	Indoor fan motor	The rotational frequency feedback signal is not emit during the 12 seconds the indoor fan operation.	Refer to 9-6.Ⓐ "Check of indoor fan motor".
12-time flash 2.5-second OFF	Indoor control system	It cannot properly read data in the nonvolatile memory of the indoor electronic control P.C. board.	Replace the indoor electronic control P.C. board.

**NOTE:** Blinking patterns of this mode differ from the ones of TROUBLESHOOTING CHECK TABLE (9-4.).



### 9-3. INSTRUCTION OF TROUBLESHOOTING

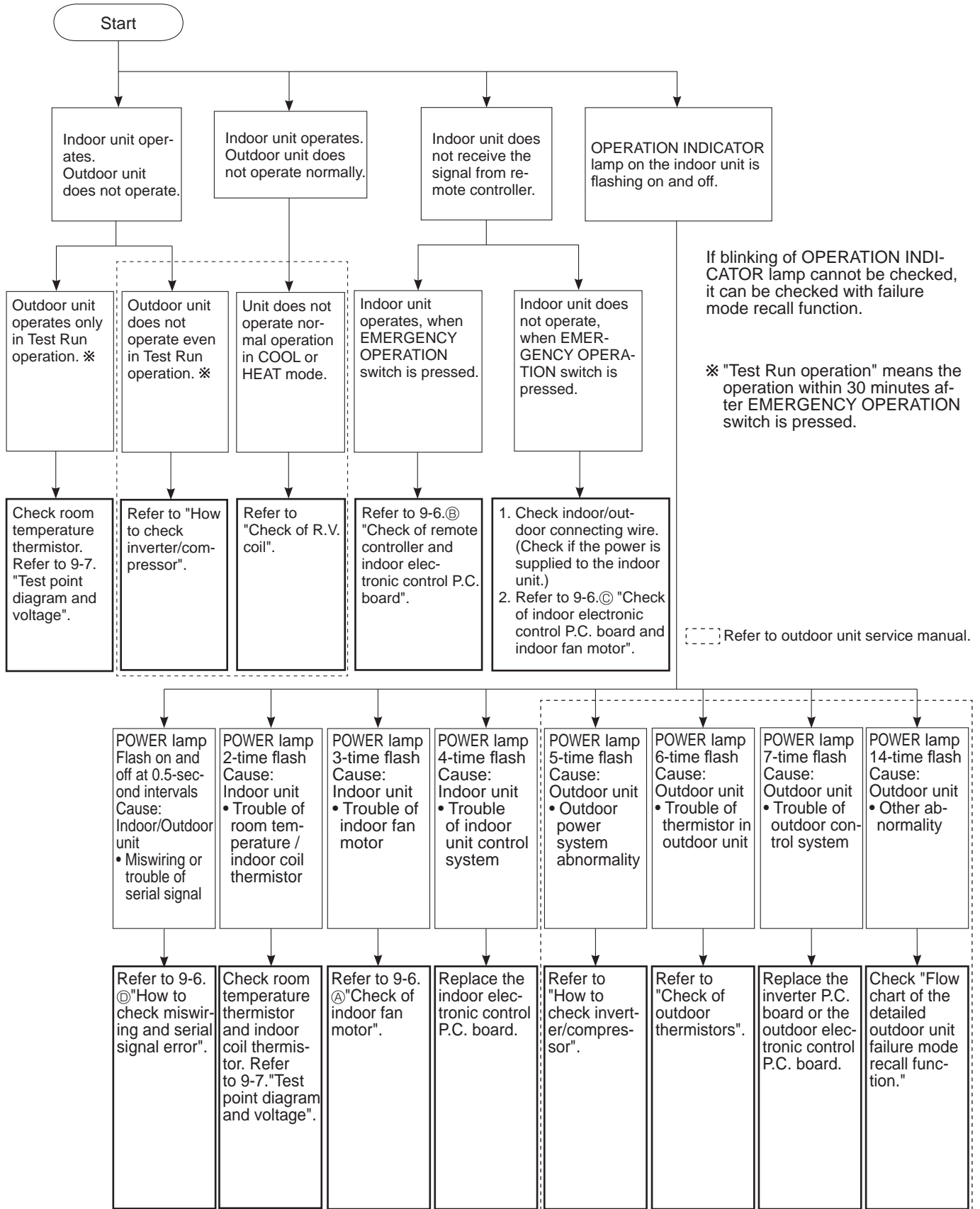

### 9-4. TROUBLESHOOTING CHECK TABLE

Before taking measures, make sure that the symptom reappears for accurate troubleshooting.  
 When the indoor unit has started operation and the following detection method has detected an abnormality (the first detection after the power ON), the indoor electronic control P.C. board turns OFF the indoor fan motor with OPERATION INDICATOR lamp flashing.



No.	Abnormal point	Operation indicator lamp	Symptom	Condition	Correspondence	
1	Miswiring or serial signal	POWER lamp flashes. 0.5-second ON ●●●●●●●● 0.5-second OFF		The serial signal from the outdoor unit is not received for 6 minutes.	• Refer to 9-6. ⑤ "How to check miswiring and serial signal error".	
2	Indoor coil thermistor Room temperature thermistor	POWER lamp flashes. 2-time flash ●●●●●●●●●●●●●● 2.5-second OFF		The indoor coil or the room temperature thermistor is short or open circuit.	• Refer to 9-7.the characteristics of indoor coil thermistor, and the room temperature thermistor.	
3	Indoor fan motor	POWER lamp flashes. 3-time flash ●●●●●●●●●●●●●● 2.5-second OFF		The rotational frequency feedback signal is not emitted during the indoor fan operation.	• Refer to 9-6. ④ "Check of indoor fan motor".	
4	Indoor control system	POWER lamp flashes. 4-time flash ●●●●●●●●●●●●●● 2.5-second OFF	Indoor unit and outdoor unit do not operate.	It cannot properly read data in the nonvolatile memory of the indoor electronic control P.C. board.	• Replace the indoor electronic control P.C. board.	
5	Outdoor power system	POWER lamp flashes. 5-time flash ●●●●●●●●●●●●●● 2.5-second OFF		It consecutively occurs 3 times that the compressor stops for overcurrent protection or start-up failure protection within 1 minute after start-up.	• Refer to "How to check of inverter/compressor". Refer to outdoor unit service manual • Check the stop valve.	
6	Outdoor thermistors	POWER lamp flashes. 6-time flash ●●●●●●●●●●●●●● 2.5-second OFF		The outdoor thermistors short or open circuit during the compressor operation.	• Refer to "Check of outdoor thermistor". Refer to outdoor unit service manual.	
7	Outdoor control system	POWER lamp flashes. 7-time flash ●●●●●●●●●●●●●● 2.5-second OFF		It cannot properly read data in the nonvolatile memory of the inverter P.C. board or the outdoor electronic control P.C. board.	• Replace the inverter P.C. board or the outdoor electronic control P.C. board. Refer to outdoor unit service manual.	
8	Other abnormality	POWER lamp flashes. 14-time flash ●●●●●●●●●●●●●● 2.5-second OFF		An abnormality other than above mentioned is detected.	• Check the stop valve. • Confirm the abnormality in detail using the failure mode recall function for outdoor unit.	
9	Outdoor control system	POWER lamp lights up ●		Outdoor unit does not operate	It cannot properly read data in the nonvolatile memory of the inverter P.C. board or the outdoor electronic control P.C. board.	• Check the blinking pattern of the LED on the inverter P.C. board or the outdoor electronic control P.C. board.

**L AREA R POWER**



No.	Abnormal point	Operation indicator lamp	Symptom	Condition	Correspondence
1	<b>MXZ type</b> Operation mode setting	POWER lamp is lighted. AREA lamps flash.  2.5-second OFF	Outdoor unit operates but indoor unit does not operate.	The operation mode of the each indoor unit is differently set to COOL (includes DRY) and HEAT at the same time, the operation mode of the indoor unit that has operated at first has the priority.	<ul style="list-style-type: none"> <li>Unify the operation mode. Refer to outdoor unit service manual.</li> </ul>

**9-5. TROUBLE CRITERION OF MAIN PARTS**  
**MSZ-FD09NA MSZ-FD12NA**

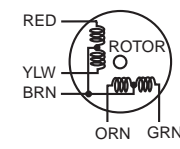
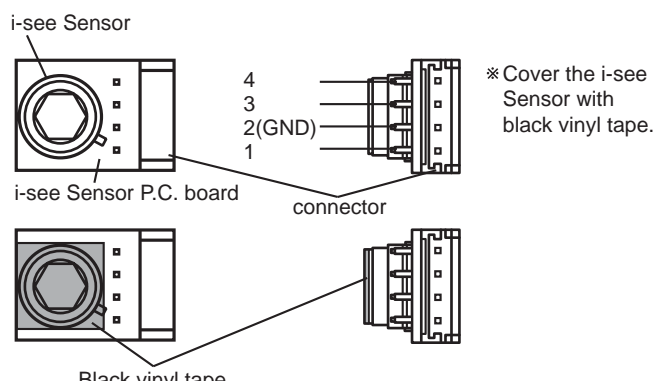
Part name	Check method and criterion	Figure										
Room temperature thermistor (RT11)	Measure the resistance with a tester.											
Indoor coil thermistor (RT12, RT13)	Refer to 9-7. "Test point diagram and voltage", "Indoor electronic control P.C. board", the chart of thermistor.											
Indoor fan motor (MF)	Check 9-6.㉔.											
Horizontal vane motor (MV1) Vertical vane motor (MV2) i-see Sensor motor (MT)	<p>Measure the resistance between the terminals with a tester.                      (Part temperature 50 ~ 86°F (10 ~ 30°C))</p> <table border="1"> <thead> <tr> <th></th> <th>Color of the lead wire</th> <th>Normal</th> </tr> </thead> <tbody> <tr> <td>Horizontal vane motor (MV1)</td> <td rowspan="3">BRN-other one</td> <td>313 ~ 375 Ω</td> </tr> <tr> <td>Vertical vane motor (MV2)</td> <td>268 ~ 322 Ω</td> </tr> <tr> <td>i-see Sensor motor (MT)</td> <td>223 ~ 268 Ω</td> </tr> </tbody> </table>		Color of the lead wire	Normal	Horizontal vane motor (MV1)	BRN-other one	313 ~ 375 Ω	Vertical vane motor (MV2)	268 ~ 322 Ω	i-see Sensor motor (MT)	223 ~ 268 Ω	
	Color of the lead wire	Normal										
Horizontal vane motor (MV1)	BRN-other one	313 ~ 375 Ω										
Vertical vane motor (MV2)		268 ~ 322 Ω										
i-see Sensor motor (MT)		223 ~ 268 Ω										
i-see Sensor (RR)	<p>Cover the i-see Sensor with black vinyl tape. Then, turn ON the power supply. (i-see Sensor is energized.) Measure the voltage between connector terminals of i-see Sensor with a tester.                      (Part temperature 50 ~ 104°F (10 ~ 40°C))</p>  <table border="1"> <thead> <tr> <th>i-see Sensor connector terminals</th> <th>Normal range</th> </tr> </thead> <tbody> <tr> <td>②(GND) - ④(+)</td> <td>1.874 ~ 3.387 VDC</td> </tr> <tr> <td>①(+)- ②(GND)</td> <td>1.010 ~ 1.420 VDC</td> </tr> </tbody> </table> <p><b>NOTE:</b> Pay attention to static electricity.</p>	i-see Sensor connector terminals	Normal range	②(GND) - ④(+)	1.874 ~ 3.387 VDC	①(+)- ②(GND)	1.010 ~ 1.420 VDC					
i-see Sensor connector terminals	Normal range											
②(GND) - ④(+)	1.874 ~ 3.387 VDC											
①(+)- ②(GND)	1.010 ~ 1.420 VDC											

## 9-6. TROUBLESHOOTING FLOW

### A Check of indoor fan motor

The indoor fan motor error has occurred, and the indoor fan does not operate.

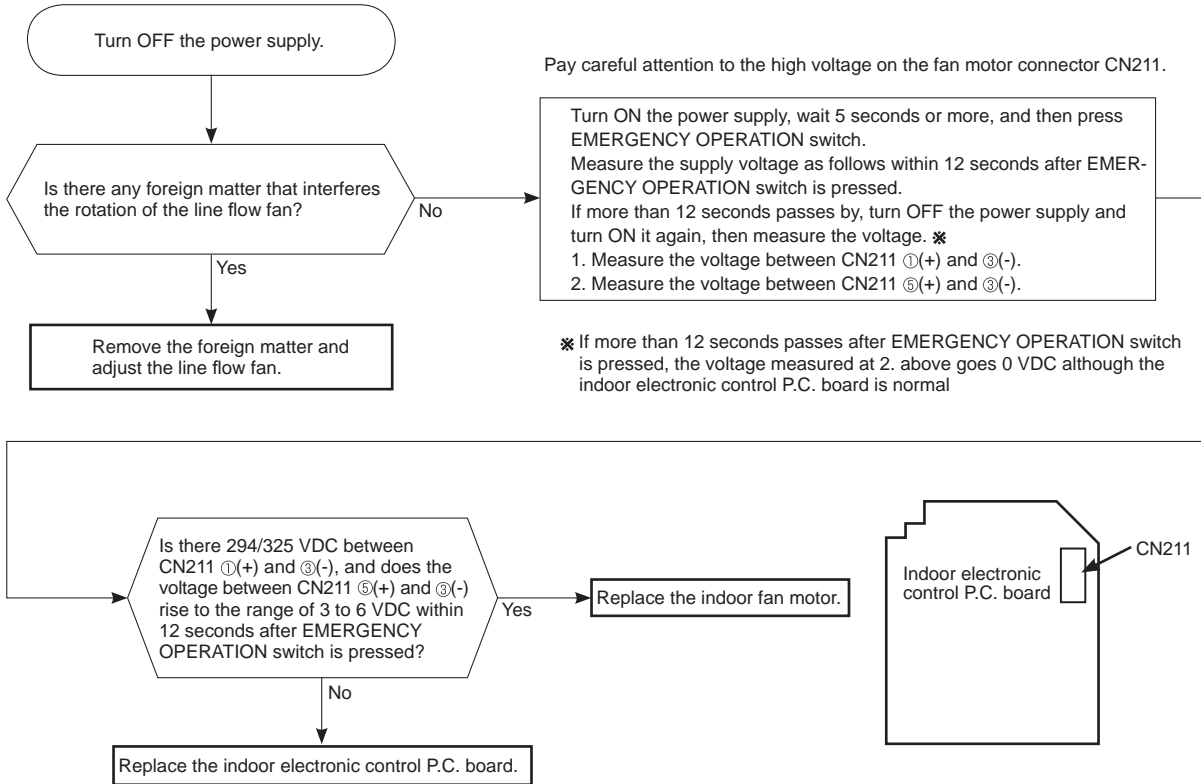

The indoor fan motor error has occurred, and the indoor fan repeats "12-second ON and 30-second OFF" 3 times, and then stops.

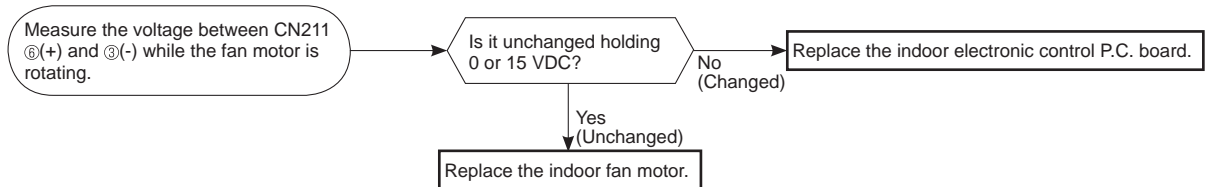

## B Check of remote controller and indoor electronic control P.C. board

※Check if the remote controller is exclusive for this air conditioner.

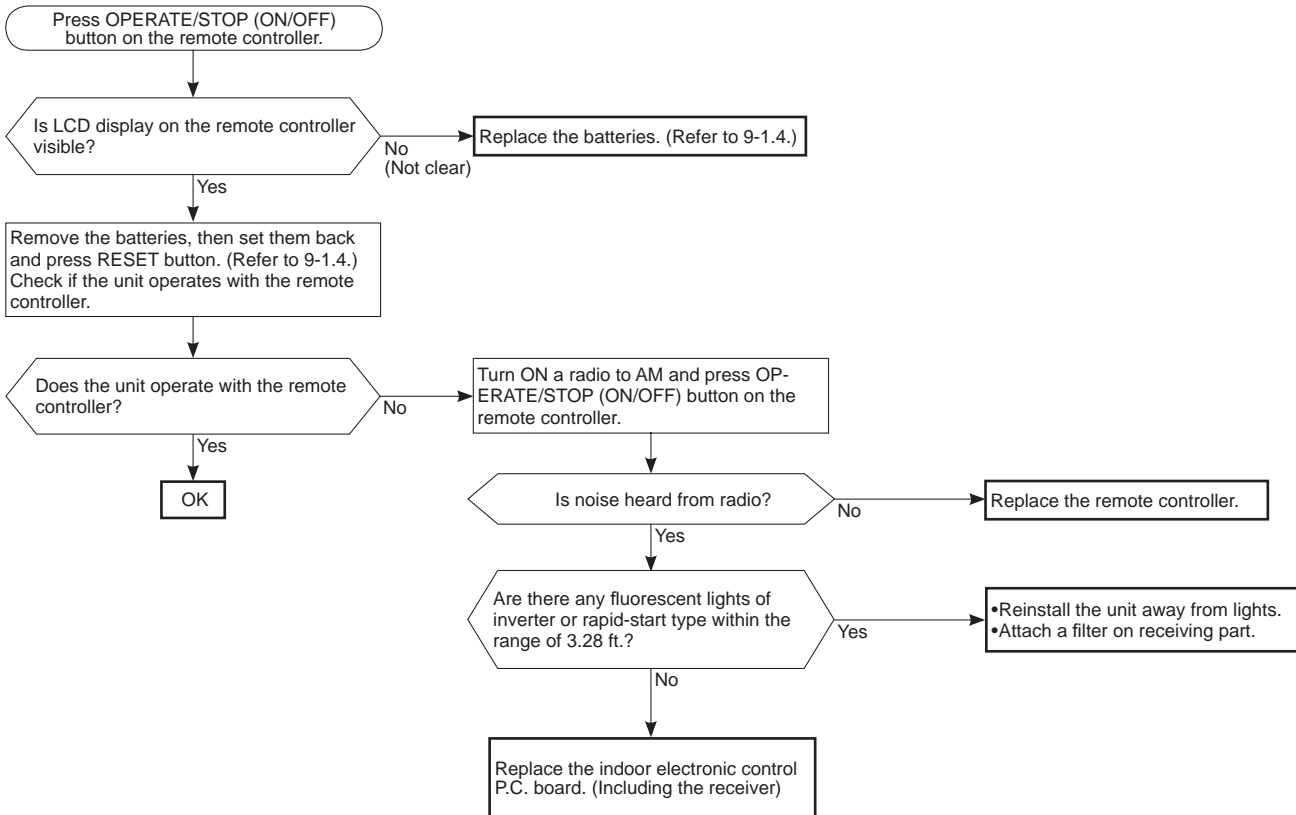

## © Check of indoor electronic control P.C. board and indoor fan motor

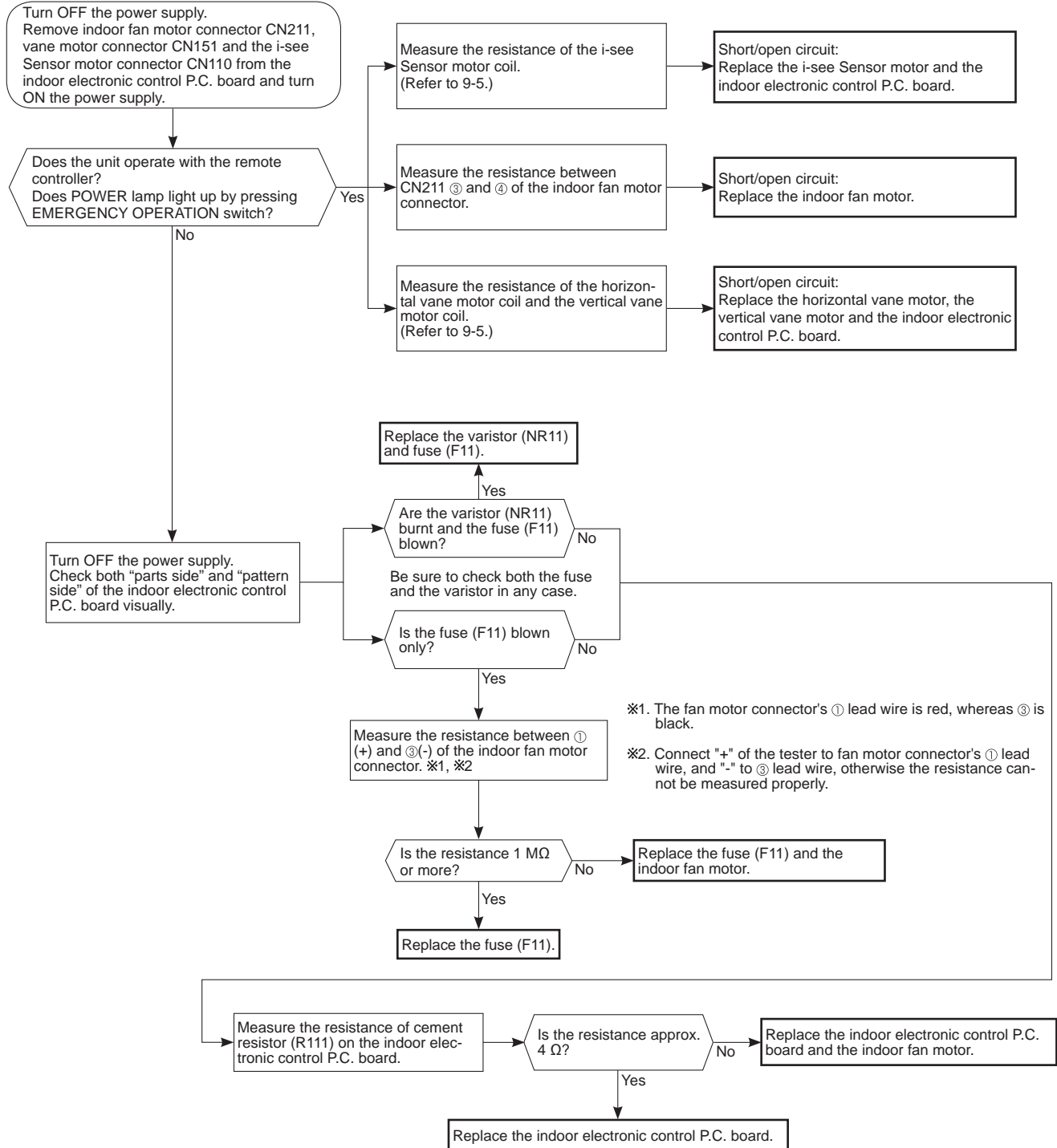

## D How to check miswiring and serial signal error

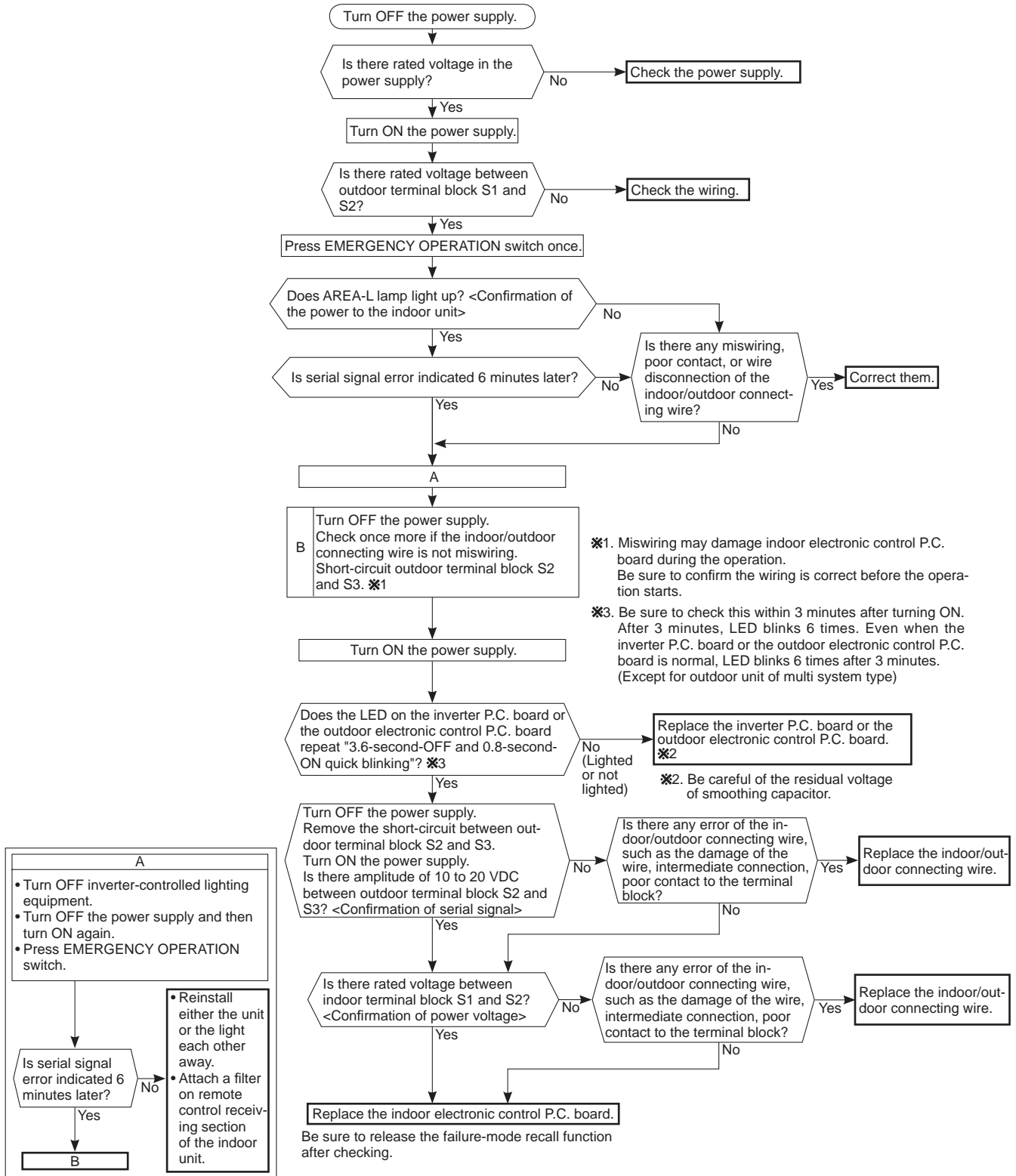



## E Electromagnetic noise enters into TV sets or radios

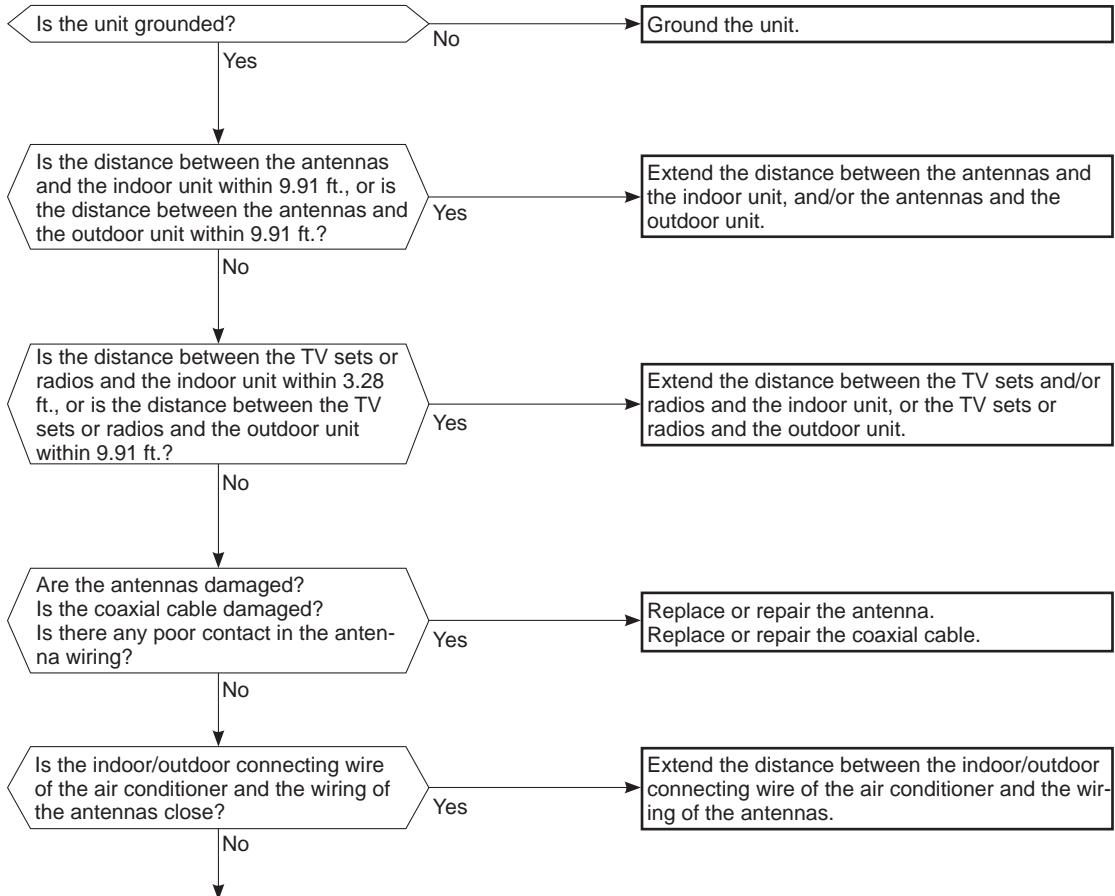

Even if all of the above conditions are fulfilled, the electromagnetic noise may enter, depending on the electric field strength or the installation condition (combination of specific conditions such as antennas or wiring). Check the followings before asking for service.

1. Devices affected by the electromagnetic noise  
TV sets, radios (FM/AM broadcast, shortwave)
2. Channel, frequency, broadcast station affected by the electromagnetic noise
3. Channel, frequency, broadcast station unaffected by the electromagnetic noise
4. Layout of:  
indoor/outdoor unit of the air conditioner, indoor/outdoor wiring, grounding wire, antennas, wiring from antennas, receiver
5. Electric field intensity of the broadcast station affected by the electromagnetic noise
6. Presence or absence of amplifier such as booster
7. Operation condition of air conditioner when the electromagnetic noise enters in
  - 1) Turn OFF the power supply once, and then turn ON the power supply. In this situation, check for the electromagnetic noise.
  - 2) Within 3 minutes after turning ON the power supply, press OPERATE/STOP (ON/OFF) button on the remote controller for power ON, and check for the electromagnetic noise.
  - 3) After a short time (3 minutes later after turning ON), the outdoor unit starts running. During operation, check for the electromagnetic noise.
  - 4) Press OPERATE/STOP (ON/OFF) button on the remote controller for power OFF, when the outdoor unit stops but the indoor/outdoor communication still runs on. In this situation, check for the electromagnetic noise.

**9-7. TEST POINT DIAGRAM AND VOLTAGE**  
**MSZ-FD09NA MSZ-FD12NA**  
 Indoor electronic control P.C. board

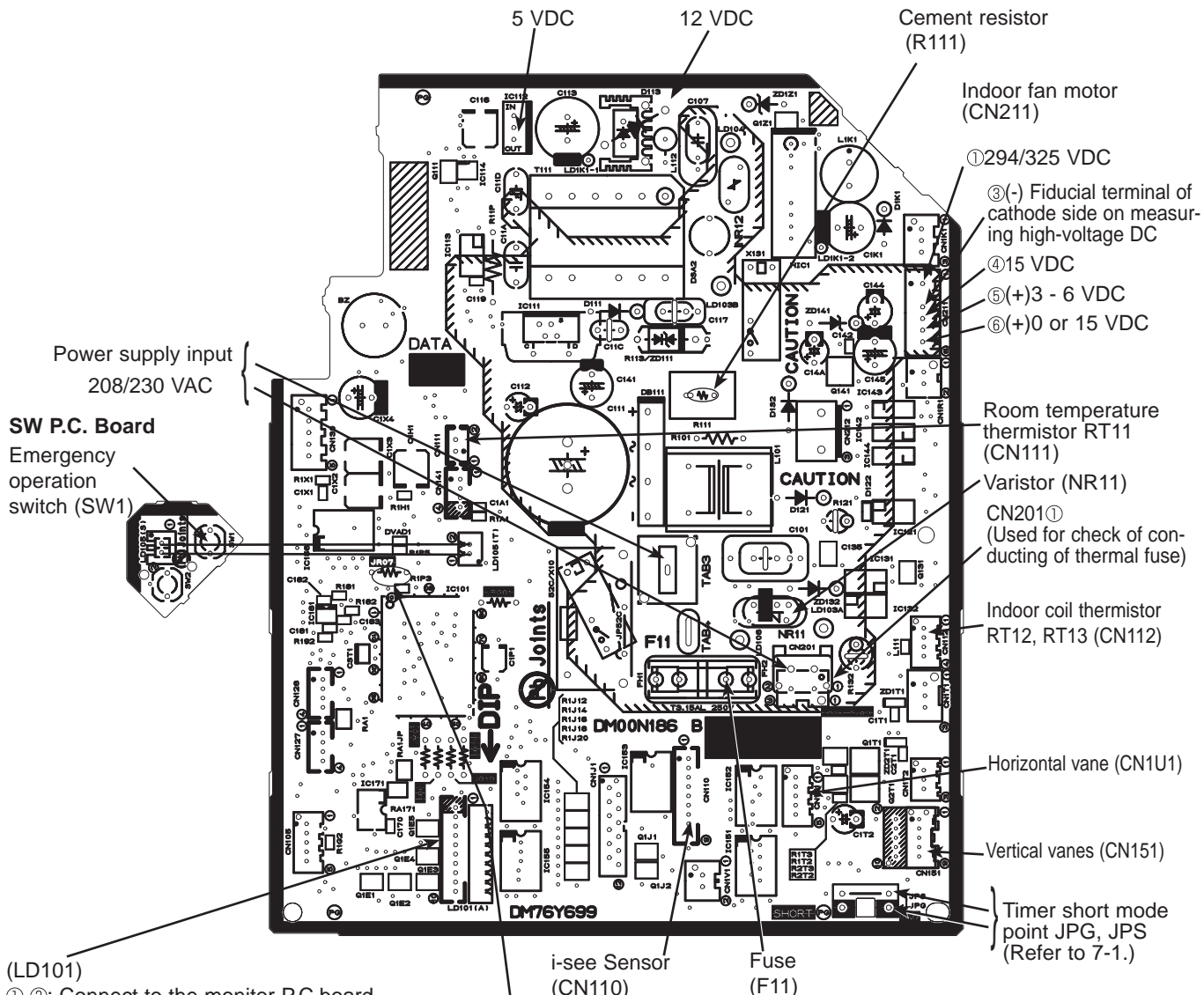

(LD101)  
 ①-③: Connect to the monitor P.C. board  
 ④-⑩: Connect to the power monitor receiver P.C. board

Release of Auto restart function  
 Solder the Jumper wire JR07  
 (Refer to 7-3.)

**Room temperature thermistor (RT11)  
 Indoor coil thermistor (RT12, RT13)**

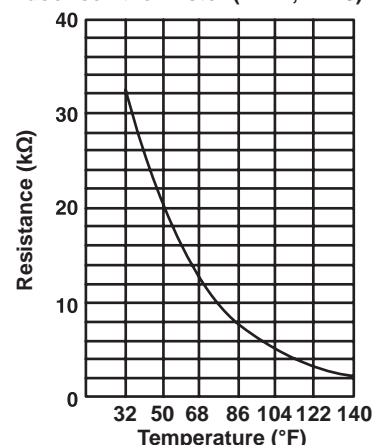

2. Power monitor receiver P.C. board

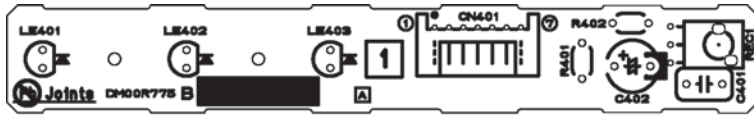

3. Monitor P.C. board

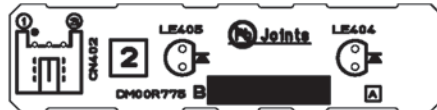

## &lt;"Terminal with locking mechanism" Detaching points&gt;

The terminal which has the locking mechanism can be detached as shown below.

There are two types (refer to (1) and (2)) of the terminal with locking mechanism.

The terminal without locking mechanism can be detached by pulling it out.

Check the shape of the terminal before detaching.

(1) Slide the sleeve and check if there is a locking lever or not.

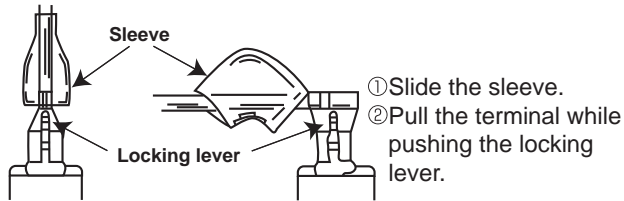

(2) The terminal with this connector has the locking mechanism.

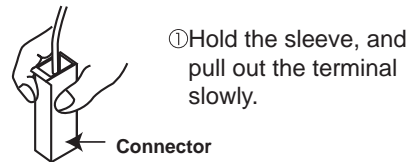

## MSZ-FD09NA MSZ-FD12NA

**NOTE:** Turn OFF power supply before disassembling.

OPERATING PROCEDURE	PHOTOS
<p><b>1. Removing the panel</b></p> <p>(1) Hold both sides of the front panel and lift the front panel until it is level. Pull the hinges forward to remove the front panel.</p> <p>(2) Remove the horizontal vanes.</p> <p>(3) Remove the screw caps of the panel. Remove the screws. (See Photo 1)</p> <p>(4) Unhook the lower part (A) of the panel.</p> <p>(5) Hold the lower part of both ends of the panel and pull it slightly toward you, and then remove the panel by pushing it upward.</p>	<p><b>Photo 1</b></p>

## OPERATING PROCEDURE

### 2. Removing the electronic control P.C. board, the power monitor receiver P.C. board, i-see Sensor, SW P.C. board and the terminal block

- (1) Remove the panel (refer to 1.) and the corner box.
- (2) Remove the screw of the conduit cover. Remove the conduit cover and the indoor/outdoor connecting wire. (See Photo 2)
- (3) Remove the sensor holder from the electrical cover. (See Photo 3)
- (4) Remove the screw of the electrical cover, and then the electrical cover. (See Photo 3)
- (5) Remove the ground wire connected to the indoor electronic control P.C. board from the electrical box. (See Photo 3.)
- (6) Remove the power monitor receiver P.C. board holder. (See Photo 4.)
- (7) Pull out the i-see Sensor from the power monitor receiver P.C. board holder.
- (\*) Install the i-see Sensor in its former position when assembling it. (See to Photo 5)
- (8) Open the rear cover of the power monitor receiver P.C. board holder and pull out the power monitor receiver P.C. board.
- (9) Open the sensor holder and pull out the SW P.C. board.
- (10) Pull the electronic control P.C. board slightly toward you from the electrical box, and disconnect TAB3 and all the connectors on the electronic control P.C. board.
- (11) Pull out the electronic control P.C. board from the electrical box.
- (12) Remove the ground wire connected to the heat exchanger from the electrical box. (See Photo 3)
- (13) Unhook the catches of the electrical box, and pull out the electrical box.
- (14) Remove the screw of the terminal block cover, and then the terminal block cover and the terminal block holder. (See Photo 2)
- (15) Remove the terminal block by sliding it.

Photo 4

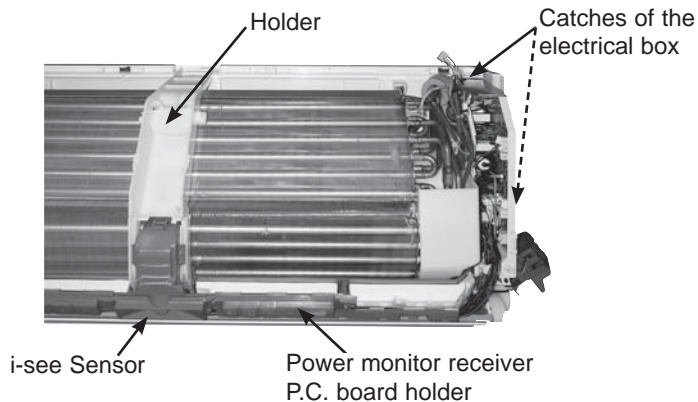

## PHOTOS

Photo 2

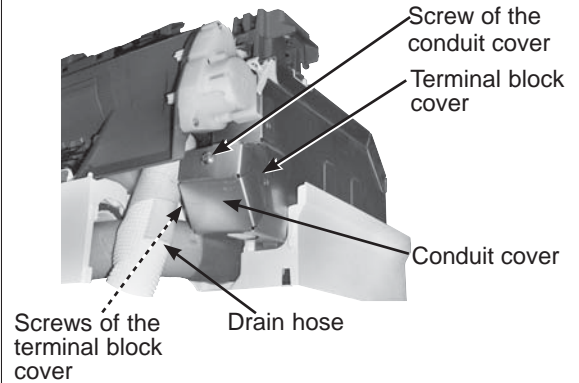
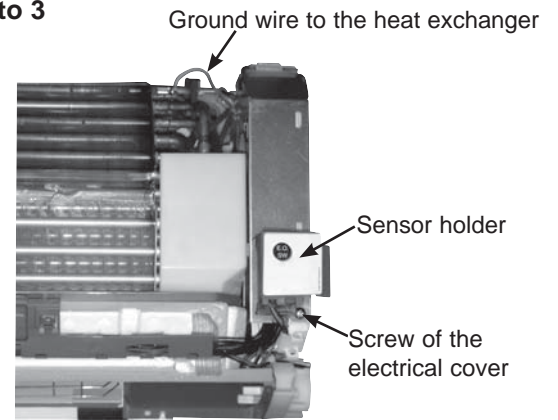
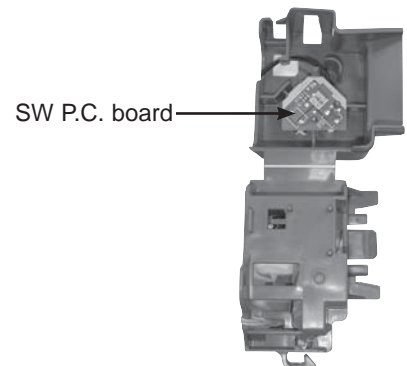

Photo 3



Sensor holder (inside)



## OPERATING PROCEDURE

## PHOTOS

### 3. Removing the electrical box

- (1) Remove the panel (refer to 1.) and the corner box.
- (2) Remove the indoor/outdoor connecting wire, the sensor holder, the electrical cover and the ground wire. (Refer to 2.)
- (3) Disconnect the following connectors on the electronic control P.C. board:
  - CN211 (Fan motor)
  - CN112 (Indoor coil thermistor)
  - CN1U1 (Horizontal vane motor)
  - CN151 (Vertical vane motor)
- (4) Unhook the catches of the electrical box, and pull out the electrical box. (See Photo 4)

Photo 5

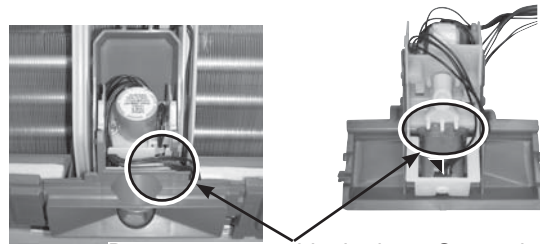

Be sure to assemble the i-see Sensor in the correct position

### 4. Removing the nozzle assembly

- (1) Remove the panel (refer to 1.) and the corner box.
- (2) Remove the conduit cover, and then the indoor/outdoor connecting wire. (See Photo 2)
- (3) Remove the sensor holder and the electrical cover. (See Photo 3.)
- (4) Disconnect the following connectors on the electronic control P.C. board:
  - CN1U1 (Horizontal vane motor)
  - CN151 (Vertical vane motor)
- (5) Remove the power monitor receiver P.C. board holder and the holder. (See Photo 4)
- (6) Pull out the drain hose from the nozzle assembly and remove the nozzle assembly.

Photo 6

Screws of the vertical vane motor unit cover

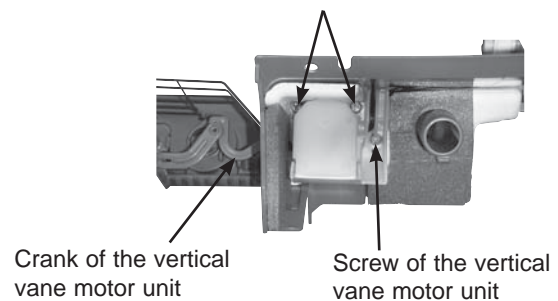

Crank of the vertical vane motor unit

Screw of the vertical vane motor unit

### 5. Removing the vertical vane motor unit

- (1) Remove the nozzle assembly. (Refer to 4.)
- (2) Remove the crank of the vertical vane motor unit from the arm of the vertical vane.
- (3) Remove the screw of the vertical vane motor unit, and pull the vertical vane motor unit.
- (4) Remove the screws of the vertical vane motor unit cover.
- (5) Remove the crank of the vertical vane motor unit from the shaft of the vane motor.
- (※) Only the crank of the left side vertical vane motor unit. (See Photo 6)
- (6) Remove the vertical vane motor from the vertical vane motor unit.
- (7) Disconnect the connector of vertical vane motor from the vertical vane motor.

Photo 7

Screws of the vertical vane motor unit cover

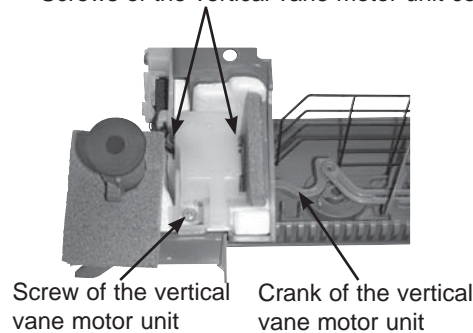

Screw of the vertical vane motor unit

Crank of the vertical vane motor unit



## OPERATING PROCEDURE

### 6. Removing the horizontal vane motor

- (1) Remove the nozzle assembly. (Refer to 4.)
- (2) Remove the screws of the horizontal vane motor unit, and pull out the horizontal vane motor unit.
- (3) Remove the screws of the horizontal vane motor unit cover.
- (4) Remove the horizontal vane motor from the horizontal vane motor unit.
- (5) Disconnect the connector from the horizontal vane motor.

### 7. Removing the indoor fan motor and the line flow fan

- (1) Remove the panel (refer to 1.) and the corner box.
- (2) Remove the sensor holder, the power monitor receiver P.C. board holder, the electrical box (refer to 3.) and the nozzle assembly (Refer to 4.).
- (4) Remove the screws fixing the motor bed. (See Photo 9)
- (5) Loosen the screw fixing the line flow fan. (See Photo 10)
- (6) Remove the motor bed together with fan motor and motor band.
- (7) Release the hooks of the motor band. Remove the motor band. Pull out the indoor fan motor.
- (8) Remove the indoor coil thermistor from the heat exchanger.
- (\*) Install the indoor coil thermistor (RT12) in its former position when assembling it. (See to Photo 12)
- (9) Remove the screws fixing the left side of the heat exchanger. (See Photo 11)
- (10) Lift the heat exchanger, and pull out the line flow fan to the lower-left.

Photo 12

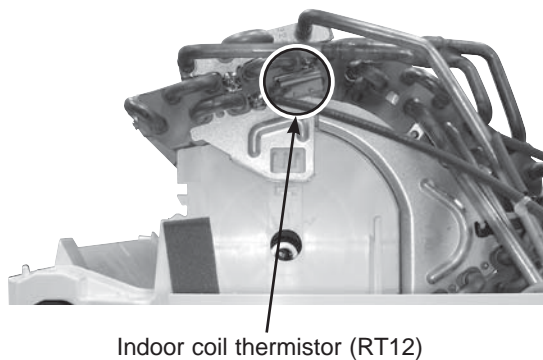

Indoor coil thermistor (RT12)

## PHOTOS

Photo 8

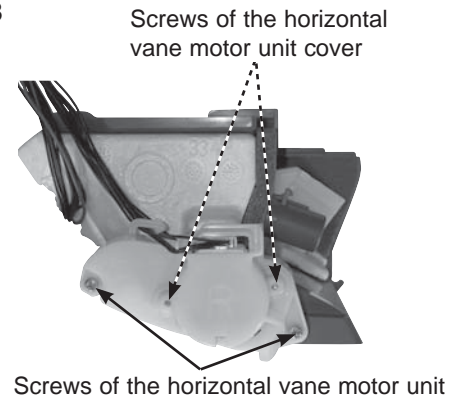

Photo 9

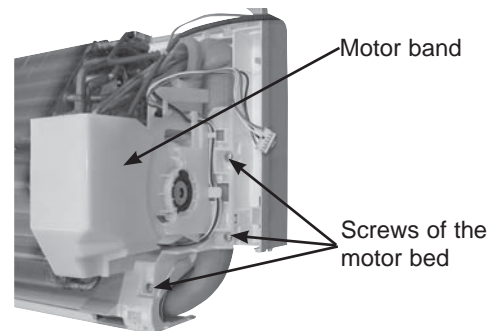

Photo 10

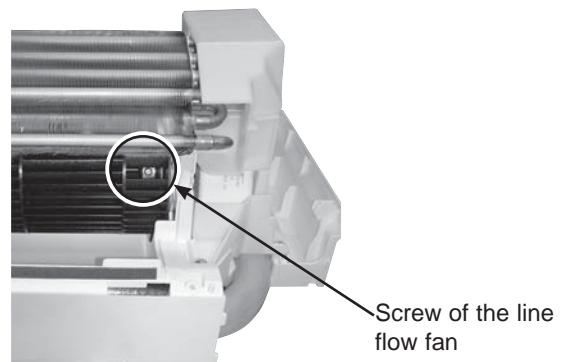
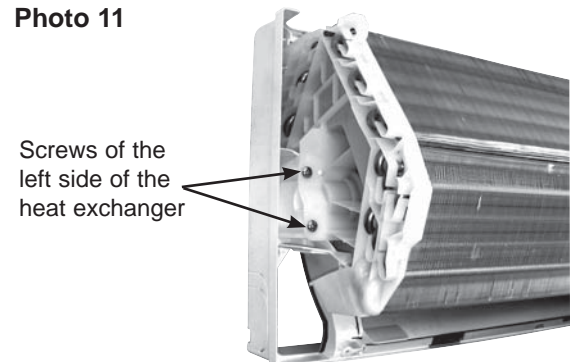

Photo 11



# **MITSUBISHI ELECTRIC CORPORATION**

HEAD OFFICE: TOKYO BLDG., 2-7-3, MARUNOUCHI, CHIYODA-KU, TOKYO 100-8310, JAPAN

© Copyright 2008 MITSUBISHI ELECTRIC CORPORATION  
Distributed in Mar. 2014. No. OBH497 REVISED EDITION-D  
Distributed in Nov. 2008. No. OBH497 REVISED EDITION-C 5  
Distributed in Apr. 2008. No. OBH497 REVISED EDITION-B 7  
Distributed in Mar. 2008. No. OBH497 REVISED EDITION-A 7  
Distributed in Jan. 2008. No. OBH497 7  
Made in Japan

New publication, effective Mar. 2014  
Specifications are subject to change without notice.