

Air Conditioning Control System

**2026**

# Service Handbook

---



## BM ADAPTER

Model name

**BACS-AP50**

# 1. Safety precautions

- ▶ Observe these precautions carefully to ensure safety.
- ▶ After reading this manual, pass the manual on to the end user to retain for future reference.
- ▶ The user should keep this manual for future reference and refer to it as necessary. This manual should be made available to those who repair or relocate the units. Make sure that the manual is passed on to any future air conditioning system user.

 <b>WARNING</b>	: indicates a hazardous situation which, if not avoided, could result in death or serious injury.
 <b>CAUTION</b>	: indicates a hazardous situation which, if not avoided, could result in minor or moderate injury.
<b>CAUTION</b>	: addresses practices not related to personal injury, such as product and/or property damage.

## 1-1. General precautions

### **WARNING**

Do not install the controller in areas where large amounts of oil, steam, organic solvents, or corrosive gases (such as ammonia, sulfuric compounds, or acids), or areas where acidic/alkaline solutions or special chemical sprays are used frequently. These substances may significantly reduce the performance and corrode the internal parts, resulting in electric shock, malfunction, smoke, or fire.

To reduce the risk of short circuits, current leakage, electric shock, malfunction, smoke, or fire, do not wash the controller with water or any other liquid.

To reduce the risk of electric shock, malfunction, smoke, or fire, do not touch the electrical parts, USB memory, or touch panel with wet fingers.

To reduce the risk of injury or electric shock, before spraying a chemical around the controller, stop the operation and cover the controller.

To reduce the risk of injury, keep children away while installing, inspecting, or repairing the controller.

If you notice any abnormality (e.g., burning smell), stop the operation, turn off the controller, and consult your dealer. Continuing the operation may result in electric shock, malfunction, or fire.

Properly install all required covers to keep moisture and dust out of the controller. Dust accumulation and the presence of water may result in electric shock, smoke, or fire.

### **CAUTION**

To reduce the risk of fire or explosion, do not place flammable materials or use flammable sprays around the controller.

To reduce the risk of electric shock or malfunction, do not touch the touch panel, switches, or buttons with a sharp object.

To avoid injury from broken glass, do not apply excessive force to the glass parts.

---

To reduce the risk of injury, electric shock, or malfunction, avoid contact with the sharp edges of certain parts.

---

Consult your dealer for the proper disposal of the controller. Improper disposal will pose a risk of environmental pollution.

---

## 1-2. Precautions for relocating or repairing the unit

### **WARNING**

The controller must be repaired or moved only by qualified personnel. Do not disassemble or modify the controller. Improper installation or repair may result in injury, electric shock, or fire.

---

## 1-3. Additional precautions

### **CAUTION**

To avoid discoloration, do not use benzene, thinner, or chemical rag to clean the controller. When the controller is heavily soiled, wipe the controller with a well-wrung cloth that has been soaked in water with mild detergent, and then wipe off with a dry cloth.

---

This appliance is not intended for use by persons (including children) with reduced physical, sensory or mental capabilities, or lack of experience and knowledge, unless they have been given supervision or instruction concerning use of the appliance by a person responsible for their safety. Children should be supervised to ensure that they do not play with the appliance.

# Contents

---

## I. About this manual

- [1] About the information in this manual ..... 2
- [2] Trademarks and registered trademarks ..... 2

## II. Be sure to read before performing service work

- [1] Safety when performing service work ..... 4
- [2] Equipment and materials required for service work ..... 4

## III. Troubleshooting

- [1] Before performing failure diagnosis ..... 6
- [2] Error judgment flow ..... 7
- [3] Error code list ..... 8
  - 1. List of error codes for errors detected by the AE-C/EW-C ..... 8
- [4] Troubleshooting and solutions depending on the equipment ..... 9
  - 1. How to determine the cause and resolve trouble based on the detected error display of the AE-C/EW-C ..... 9
  - 2. Error judgment based on the STATUS LED display of the AE-C/EW-C ..... 18
  - 3. Troubleshooting depending on the trouble symptoms of the AE-C/EW-C and trouble examples ..... 20
- [5] M-NET transmission waveform and noise check procedure ..... 31
- [6] LAN communication error check procedure ..... 34
  - 1. About the preliminary check items ..... 34
  - 2. About the check method using ping ..... 37
- [7] Peak cut troubleshooting ..... 40
- [8] Energy management troubleshooting ..... 41
- [9] Troubleshooting for apportioned electricity billing function ..... 42
- [10] Troubleshooting (BACnet function) ..... 58
- [11] Troubleshooting for chiller unit connection function ..... 62
- [12] Troubleshooting for HWHP (QAHV) ..... 63
- [13] R32 refrigerant leak buzzer failure ..... 67
- [14] Controller replacement ..... 67
- [15] microSD card replacement - Restore overview ..... 68
  - 1. microSD card write/read error ..... 68
  - 2. microSD card replacement procedure ..... 68
  - 3. STATUS LED indication after replacement of microSD cards ..... 73

## IV. Appendix

- [1] How to Use Wireshark for AE-C/EW-C BACnet ..... 75
  - 1. Repeater hub ..... 75
  - 2. Port Mirroring ..... 76
  - 3. Wireshark Start ..... 76
  - 4. "Filter" on monitoring screen ..... 80
  - 5. Examples ..... 81
  - 6. Wireshark Stop ..... 83
- [2] Electrical Wiring Diagram ..... 84
  - 1. AE-C ..... 84
  - 2. EW-C ..... 84

# I. About this manual

---

[1] About the information in this manual .....	2
[2] Trademarks and registered trademarks .....	2

# I. About this manual

## [1] About the information in this manual

This manual contains information regarding service work for the BM adapter BACS-AP50.

- About BACS-AP50
  - **For BACS-AP50, please refer to EW-C in this manual.**
  - The following are not covered by BACS-AP50.
    - III [7] Peak cut troubleshooting
    - III [8] Energy management troubleshooting
    - III [9] Troubleshooting for apportioned electricity billing function
    - III [12] Troubleshooting for HWHP (QAHV)
    - III [13] R32 refrigerant leak buzzer failure
- Terms used in this manual
  - “Microsoft® Windows 10” is referred to as “Windows 10”, and “Microsoft® Windows 11” is referred to as “Windows 11”.
  - “Centralized Controller AE-C400\* and EW-C50\*” is referred to as “AE-C/EW-C”.
  - “OA Processing unit (LOSSNAY with heater and humidifier)” is referred to as “OA Processing unit”.
  - “e-Series chiller unit (EAHV, EACV)” is referred to as “Chiller unit”.
- About screen display
  - The screens displayed in this manual may differ from those of the latest version.

## [2] Trademarks and registered trademarks



MicroSDHC logo is a trademark of SD-3C, LLC.

Android and Google Chrome are trademarks of Google LLC.

BACnet is a registered trademark of ASHRAE.

IOS is a trademark or registered trademark of Cisco in the U.S. and other countries and is used under license. iOS is the name of the operating system developed by Apple Inc. and is used under license.

iPad, iPad mini, iBooks, Safari, macOS, and Apple are trademarks of Apple Inc. registered in the U.S. and other countries. Microsoft, Windows, Excel, Microsoft Edge, and Windows Server are registered trademarks of Microsoft Corporation in the U.S. and other countries.

Oracle and Java are registered trademarks of Oracle Corporation and/or its affiliates in the U.S. and other countries. Other company names and product names shown in this manual may be trademarks or registered trademarks of their respective companies.

## II. Be sure to read before performing service work

---

[1] Safety when performing service work .....	4
[2] Equipment and materials required for service work .....	4

## II. Be sure to read before performing service work

### [1] Safety when performing service work

**Be sure to carefully read “Safety Precautions” at the beginning of this manual and perform service work while paying attention to safety.**

To ensure inspection and replacement work is performed safely, observe the following precautions when performing the work.

1. Turn off the breakers	Before replacing parts, be sure to turn off the breaker in the control panel and the main breaker outside the control panel to shut off the power supply to the AE-C/EW-C.
2. Take electrical shock precautions	If inspection work must be performed while the equipment is energized, do not touch live parts and take sufficient precautions against electric shock.
3. Use appropriate tools	Use appropriate tools for inspection and replacement work. Using worn out tools may result in an accident due to inadequate tightening, contact failure, etc.
4. Ground	Be sure to ground the equipment. Furthermore, inspect the grounding state and perform the work again if the grounding is inadequate. (When handling circuit boards with electronic components, take measures to remove static electricity.)
5. Clean	After performing the inspection and replacement work, clean the equipment and the area around the equipment and then notify the customer that the inspection and replacement work is complete.

### [2] Equipment and materials required for service work

Prepare the following equipment and materials for the service work. (Note: Prepare the items that will be required for the particular site.)

<Tools>

- Screwdriver

<Measuring instruments>

- Mutimeter: Used to check the wiring and voltage.
- Oscilloscope: Used to check the M-NET transmission waveform.

<Reference materials>

- Diagram of air conditioning control system at the site
- BACS-AP50 Installation Manual
- BACS-AP50 Instruction Book (Detailed operations)
- AE-C/EW-C/BACS-AP50 Instruction Book (BACnet function)  
(For the functional differences between AE-C/EW-C and BACS-AP50, refer to section “Controller functions and BACnet functions” in the manual above.)
- AE-C/EW-C/BACS-AP50 Instruction Book (BACnet Trial Run Tool)
- Service Handbook (this manual)
- Air conditioning Unit Service Handbook
- Air conditioning Unit Service Parts Catalog

<Other items>

- License numbers: License numbers of AE-C/EW-C required for the functions to be used  
(Required when new installation, replacement, etc.)  
(Not required for BACS-AP50)
- USB memory device: Used to back up the initial settings data.  
(Use a USB Type-C 3.2 Gen 1 (FAT32 format, no encryption))
- PC: Used for various tools and Web display.
- LAN cable: 100BASE-TX compatible LAN cable (category 5 or better)
- User name and password settings: User name and password for AE-C/EW-C and Integrated Web browser (when changed from the default setting)

# III. Troubleshooting

---

[1] Before performing failure diagnosis .....	6
[2] Error judgment flow .....	7
[3] Error code list .....	8
1. List of error codes for errors detected by the AE-C/EW-C .....	8
[4] Troubleshooting and solutions depending on the equipment .....	9
1. How to determine the cause and resolve trouble based on the detected error display of the AE-C/EW-C .....	9
2. Error judgment based on the STATUS LED display of the AE-C/EW-C .....	18
3. Troubleshooting depending on the trouble symptoms of the AE-C/EW-C and trouble examples .....	20
[5] M-NET transmission waveform and noise check procedure .....	31
[6] LAN communication error check procedure .....	34
1. About the preliminary check items .....	34
2. About the check method using ping .....	37
[7] Peak cut troubleshooting .....	40
[8] Energy management troubleshooting .....	41
[9] Troubleshooting for apportioned electricity billing function .....	42
[10] Troubleshooting (BACnet function) .....	58
[11] Troubleshooting for chiller unit connection function .....	62
[12] Troubleshooting for HWHP (QAHV) .....	63
[13] R32 refrigerant leak buzzer failure .....	67
[14] Controller replacement .....	67
[15] microSD card replacement - Restore overview .....	68
1. microSD card write/read error .....	68
2. microSD card replacement procedure .....	68
3. STATUS LED indication after replacement of microSD cards .....	73

## III. Troubleshooting

### [1] Before performing failure diagnosis

If the AE-C/EW-C is not operating normally, first check the following items.

(The following items are for the maximum system configuration. Just check the items for the applicable equipment.)

No.	Item	Yes	No
1	Are the AE-C/EW-C, PC, PLC, HUB, power supply unit, and other equipment and air conditioning units powered on?		
2	Is a power cable or transmission line disconnected?		
3	Is 100 to 240 VAC applied on the AC power cable of the AE-C/EW-C?		
4	Is 17 to 32 VDC applied on the M-NET transmission line?		
5	Have the initial settings been configured for the AE-C/EW-C and each equipment?		
6	Are the correct date and time set on the AE-C/EW-C?		
7	Is the required license number registered for each AE-C/EW-C? * Not applicable for BACS-AP50		
8	Is a LAN cable disconnected? (Are the LAN cables compliant with the relevant standards?)		
9	Are the external input/output terminals disconnected? * Not applicable for BACS-AP50		
10	Is the IP address of each equipment set?		
11	Is a terminal screws loose or a connector not inserted properly?		

If you answered "No" for any of the above items, remove the cause for that item.

If there is no problem, refer to the following sections.

## [2] Error judgment flow

If it is suspected that the AE-C/EW-C is not operating properly, follow the flow chart below for diagnosis.

\* For the location of the LEDs, refer to "III [4] 2. Error judgment based on the STATUS LED display of the AE-C/EW-C".

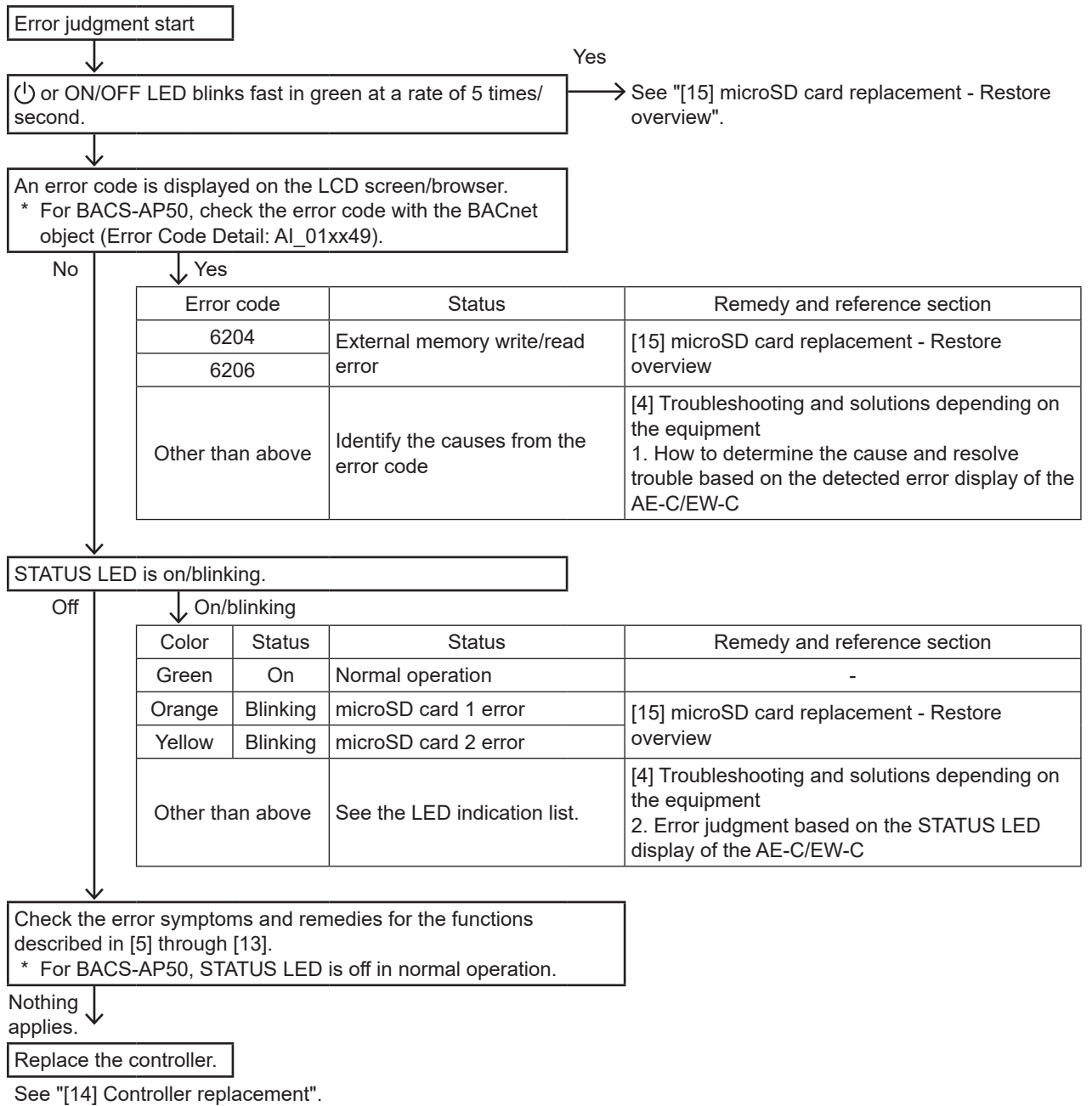

**[3] Error code list**

**1. List of error codes for errors detected by the AE-C/EW-C**

The following shows the error codes of errors detected by the AE-C/EW-C.

Error code	Error description	Unit where error occurred				Remarks
		Outdoor unit	Indoor unit	Remote controller	AE-C/EW-C	
0092	Version combination error				○	
0094	“Charge” license not registered				○	
0095	Warning - possibility of damaged metering device				○	
0097	Apportioned calculation data collection error				○	
0098	Operation data collection error				○	
0099	Meter rewinding error					PI controller
6204/6206	External memory read/write error				○	
6600	Communication error - M-NET Address duplicate	○	○	○	○	
6601	Communication error - M-NET Polarity unsettled				○	
6603	Communication error - Transmission line busy				○	
6607	Communication error - M-NET No ACK return	○	○	○		
6608	Communication error - M-NET No return of response frame	○	○	○		
6920	Communication error - No response				○	
6930	Modbus communication error				○	
7106	System abnormality - M-NET Attribute setting error				○	
7109	System abnormality - M-NET Connection setting error				○	
7130	System abnormality - Combination error				○	
7905	Version error				○	

For details on the error codes, refer to “III [4] Troubleshooting and solutions depending on the equipment.”

[Supplementary explanation] Error codes 0092 to 0095 and 0097 are for error occurrences of the AE-C/EW-C and are stored in the error history.

Error codes 6607 and 6608 are detected only by the AE-C/EW-C and are for error occurrences of the AE-C/EW-C and are stored in the error history.

For the BACS-AP50, the following error codes are not applicable.

Error code	Error description
0092 to 0095, 0097 to 0099	Billing application error
6204/6206	External memory read/write error
6920	Communication error - No response
6930	Modbus communication error
7900 to 7999	System error

## [4] Troubleshooting and solutions depending on the equipment

### 1. How to determine the cause and resolve trouble based on the detected error display of the AE-C/EW-C

The following shows the details, causes, and solutions for the error codes of errors detected at the detection source by the AE-C/EW-C.

First confirm that there is no mistake for each setting.

\* The detection address displayed on the error monitor and in the error history is the address of the controller that detected the error.

Error code	Description and method of detection	Cause	Check procedure and remedy
0092	Version combination error Error detected when the versions of the AE-C/EW-C are not a compatible combination for the apportioned electricity billing function.	1) Although the apportioned electricity billing function of the AE-C/EW-C has been enabled, the software versions of the connected AE-C/EW-C controllers do not match.	The apportioned electricity billing function does not work while this error code is displayed. Update the software of the connected AE-C/EW-C. Note: Data will be absent for up to 30 minutes from the time the AE-C/EW-C recovers from the error.
0094	“Charge” license not registered Error detected when a license is not registered to any of the AE-C/EW-C while the apportioned electricity billing function is enabled for an AE-C/EW-C without an apportioned electricity billing function license.	1) With the apportioned electricity billing function of the AE-C/EW-C, the “Charge” license needs to be registered to all the AE-C/EW-C under the control of the AE-C/EW-C, but there is equipment to which it is not registered.	The apportioned electricity billing function of the AE-C/EW-C does not operate while this error code is displayed. Register the “Charge” license to all the AE-C/EW-C. For details, refer to the AE-C/EW-C Instruction Book (Detailed operations).
0095	Warning - possibility of damaged metering device Error detected when the state of the measurement value of the meter not counting up continues for at least three days even though the operation amount of the air conditioning units is being counted up while the apportioned electricity billing function of the AE-C/EW-C is enabled.	1) There is a wiring connection failure between the electricity meter and PI controller. (When a PI controller is used) 2) There is a wiring connection failure between the electricity meter and CN10 of the AE-C/EW-C. (When meter Modbus interface of the AE-C/EW-C is used) 3) There is an error with communication between the PI controller and AE-C/EW-C. 4) An electricity meter with pulse output of 10 kWh/pulse or higher is being used. 5) The carried-over data was not cleared after the time period of the unit price was deleted.	Causes 1 to 3) Check the wiring connections to ensure there is no connection mistake or broken/disconnected wire. Cause 4) If an electricity meter with a large pulse output such as 10 kWh/pulse is used, three days or longer may be required to add one pulse depending on the operating conditions of the air conditioning units. If changing the pulse output of the electricity meter is possible, change it to a value such as 1 kWh/pulse. Cause 5) Perform the carried-over data clearing process for the deleted unit price. For how to clear the carried-over data, refer to AE-C/EW-C Instruction Book (Detailed operations). Note: The equipment recovers from the error and then data collection resumes after a maximum of 30 minutes elapse.

Error code	Description and method of detection	Cause	Check procedure and remedy
0097	<p>Apportioned calculation data collection error</p> <p>Error detected when an error with communication between the AE-C/EW-C continues for at least three days while the apportioned electricity billing function of the AE-C/EW-C is enabled.</p> <p>* When the communication error is less than three days and the apportioned electricity billing function of the AE-C/EW-C is disabled, the error will be 6920.</p>	<ol style="list-style-type: none"> <li>1) LAN contact failure</li> <li>2) The power of the HUB is not on.</li> <li>3) The IP address has not been set.</li> <li>4) Is the length of the LAN cable 100 m (328 ft) or less?</li> <li>5) Is the transmission delay time 4 seconds or less round trip?</li> </ol>	<p>Cause 1) Check that the LAN cables between the AE-C/EW-C and HUB are connected.</p> <p>Cause 2) Check that the power of the HUB is on.</p> <p>Cause 3) Check the IP address of the AE-C/EW-C.</p> <p>Cause 4) Use LAN cables that are 100 m (328 ft) or less.</p> <p>Cause 5) Check the communication state by pinging. For the ping check method, refer to "III [6] 2. About the check method using ping." If the ping is timed out, check the following.</p> <ul style="list-style-type: none"> <li>• Are LAN cables of category 5 or better being used?</li> <li>• Is there not connections to four or more layers using a gateway, router, etc.?</li> </ul>
0098	<p>Operation data collection error</p> <p>The operation data obtained at the time of apportioned calculation show that data of some indoor units have not been updated.</p>	<ol style="list-style-type: none"> <li>1) This error is detected when there is a discrepancy between the refrigerant system settings held by the AE-C/EW-C and the refrigerant system configuration actually in operation. This error occurs when the AE-C/EW-C is restarted with the power to the outdoor units or indoor units in operation shut off.</li> <li>2) Regardless of the conditions given in 1), this error may be detected at the time of the first apportioned calculation after the AE-C/EW-C is restarted.</li> </ol>	<p>Cause 1) Turn on the power to the outdoor units, indoor units, etc. and check that there is no problem with the communication of the entire system. Then, if necessary, change the settings of "Group Settings" and "Refrigerant System Settings" of the Initial Setting Tool according to the refrigerant system configuration that is actually in operation.</p> <p>Cause 2) When the AE-C/EW-C recovers from the error in 30 minutes from the occurrence of the error, there is no problem with the apportion results. No actions need to be taken.</p>
0099	<p>Meter rewinding error</p> <p>The difference of the measured value data obtained at the time of apportioned calculation is 500000 (half of the limit value) or above.</p>	<ol style="list-style-type: none"> <li>1) The total amount of electric energy of the PI controller has suddenly been reset. (Sudden operation error, etc.)</li> <li>2) The PI controller has failed.</li> <li>3) After the PI controller was replaced, the comparison data of the metering device were not cleared.</li> </ol>	<p>Cause 1) - 2) Inspect and replace the faulty PI controller. After replacing the PI controller, clear the comparison data of the metering device. Since apportionment is not implemented during the period of failure, correct the apportioned data.</p> <p>Cause 3) Clear the comparison data of the metering device.</p>
6204 6206	<p>External memory read/write error</p> <p>Error detected when writing or reading to/from the internal SD card of the AE-C/EW-C could not be performed properly.</p>	<ol style="list-style-type: none"> <li>1) An error occurred because the reading or writing from/to the internal SD card could not be performed due to an unexpected erroneous operation of the AE-C/EW-C on which the error occurred.</li> <li>2) The internal SD card has come out of the slot.</li> <li>3) The AE-C/EW-C has malfunctioned (circuit failure, etc.).</li> </ol>	<p>See "[15] microSD card replacement - Restore overview".</p>

Error code	Description and method of detection	Cause	Check procedure and remedy
6600	<p>Communication error - Address duplicate</p> <p>Error detected when units with the same address are transmitting.</p>	<p>1) There are two more units with the same address among the AE-C/EW-C, outdoor units, indoor units, LOSSNAY, M-NET remote controllers, and other units.</p> <p>2) Two or more AE-C/EW-C with the same address set are installed in the same transmission line system.                      &lt;Example&gt; The part in ( ) indicates the detection source.                      000-6600(000)                      There are two or more controllers with the address "000".</p> <p>3) The transmitted data changed due to noise during transmission.</p> <p>4) TB3 of the AE-C/EW-C is not properly powered.</p>	<p>Causes 1) and 2) Find the unit that has the same address as the unit where the error occurred.</p> <div style="border: 1px solid black; padding: 5px; margin: 5px 0;"> <p>If the same address could be verified, check whether there are any mistakes with the wiring and whether there are any mistakes with the addresses in the system, and fix any mistakes you find. Turn off the power of the air conditioning units, controllers, and other equipment at the same time, leave it off for at least 5 minutes, and then turn it back on.</p> </div> <p>Cause 3) Check the transmission waveform and noise on the transmission line. For the check procedure, refer to "III [5] M-NET transmission waveform and noise check procedure."</p> <p>Cause 4) Check TB3 for proper connection, and check the power supply device for proper connection and operation.</p>

Error code	Description and method of detection	Cause	Check procedure and remedy
6601	Communication error - Polarity unsettled 1. Error detected when the transmission processor which is an M-NET communication component cannot verify the + and - voltage polarity of the M-NET transmission line.	1) There is no voltage between the M-NET transmission line connected to the AE-C/EW-C. 2) The M-NET transmission line connected to the AE-C/EW-C is shorted.	Causes 1) and 2) Check whether there is a voltage to the M-NET transmission line of the AE-C/EW-C and fix any wiring work mistakes. Cause 3) Check whether power is being supplied to the M-NET transmission line from multiple equipment, and fix the power supply configuration if it is incorrect.
	2. Detected invalid signal due to a transmission waveform error or noise on the M-NET transmission line.	1) Contact failure of the transmission line of an outdoor unit or indoor unit. 2) Attenuation of the transmission voltage/signal because the allowable range for the transmission line wiring has been exceeded. • Farthest end: Exceeds 200 m (656 ft) • Remote controller line: Exceeds 10 m (32 ft) However, there is no problem if the portion where the remote controller line exceeds 10 m (32 ft) is 1.25 mm <sup>2</sup> . 3) Attenuation of the transmission voltage/signal because mismatch of transmission line types Wire diameter: Less than 1.25 mm <sup>2</sup> 4) The M-NET power supply is duplex feeding and has a same polarity connection. 5) Failure of control board in the outdoor unit	Causes 1) to 5) → If you find the cause, fix the problem. → If you cannot find the cause, check the transmission waveform and noise on the transmission line. Perform the check procedure in accordance with "III [5] M-NET transmission waveform and noise check procedure" and <Transmission waveform and noise check procedure> in the Service Handbook of the air conditioning unit. The part causing the error may be a different line than the one where the error was detected so check all wiring in the same system.
	3. Polarity not set error	1) Defective AHC ADAPTER	Check the voltage and short circuit. Replace the product.
6603	Communication error - Transmission line busy 1. Collision over error. Error when the state of data not being able to be transmitted continues for a period of 4 to 10 minutes due to a transmission collision. 2. Error when the state of data not being output to the transmission line continues for a period of 4 to 10 minutes due to, for example, noise.	1) The transmission processor is in the state of being unable to transmit due to a voltage of a short period such as noise continuing to be generated and causing an interference on the transmission line. 2) Failure of controller on which error occurred. 3) Defective AHC ADAPTER	Check the transmission waveform and noise on the transmission line. Perform the check in accordance with <Transmission waveform and noise check procedure>. → If there is no noise, the controller at the source of occurrence has failed. If the AE-C/EW-C has failed, replace the AE-C/EW-C. → If there is noise, refer to "III [5] M-NET transmission waveform and noise check procedure." Refer to the CITY MULTI (Outdoor Unit) Service Handbook.

Error code	Description and method of detection	Cause	Check procedure and remedy
6604	<p>M-NET communication error - No ACK return</p> <p>Error detected by AHC ADAPTER when the other party fails to return the ACK signal after a command transmission on M-NET.</p>	<ol style="list-style-type: none"> <li>1) Incorrect initial settings</li> <li>2) The address of the other party on the M-NET transmission line changed during transmission.</li> <li>3) Defective M-NET transmission line</li> <li>4) Transmission line or connector disconnected at the address of the other party in M-NET communications.</li> <li>5) Other party in M-NET communications is effective</li> <li>6) For communications about multiple refrigerants, the transmission line or connector is disconnected from the terminal block for centralized control (TB7).</li> <li>7) For communications about multiple refrigerants, power is cut to an outdoor unit.</li> <li>8) For communications about multiple refrigerants, the power connector (CN40) was not inserted in an outdoor unit.</li> <li>9) For communications about multiple refrigerants, two or more power connectors (CN40) were inserted for centralized control.</li> <li>10) For communications about multiple refrigerants, an outdoor unit power supply system is defective.</li> <li>11) Transmitted data changed due to noise on the M-NET transmission line.</li> </ol>	<p>An AHC ADAPTER No ACK return error was displayed on the remote controller or centralized controller.</p> <p>Follow the procedure below to determine the address of the unit that caused the AHC ADAPTER error.</p> <ol style="list-style-type: none"> <li>(1) Use the centralized controller or Maintenance Tool to check for abnormalities in the I/O data held in Mitsubishi air conditioners set by the initial settings. (No value is displayed when data is abnormal.) → If an abnormality exists, check for problems in the unit at the address where the corresponding data is held and for problems in the M-NET transmission line connected to the unit or in the unit itself. (For communications about multiple refrigerants, also investigate intermediate outdoor units.)</li> <li>(2) Check for incorrect remote controller or centralized controller settings that do not correspond to (1) above.  → If incorrect settings are discovered at steps (1) or (2), use Maintenance Tool to repeat the initial settings.</li> </ol> <p>If the cause does not correspond to steps (1) or (2), check for noise in the M-NET transmission line.</p>
6605	<p>M-NET communication error - No return of response frame</p> <p>Error indicating that the ACK signal was returned to acknowledge receipt but no response was returned when a communication command was sent over M-NET.</p>	<ol style="list-style-type: none"> <li>1) Transmission line work was performed while power is supplied to M-NET.</li> <li>2) Transmitted data changed due to noise on the M-NET transmission line.</li> <li>3) Transmission line voltage/signal attenuation as M-Net transmission line exceeded its permitted length range. Remote end: 200 m max.</li> <li>4) Transmission line voltage/signal attenuation due to mismatch in M-Net transmission line types. Cable cross-sectional area: 1.25 mm<sup>2</sup> min.</li> </ol>	<p>Cut the power supply from the unit (outdoor unit or power supply unit) that supplies power to AHC ADAPTER, or reset the error from the remote controller or centralized controller.</p> <p>→ If the same error recurs, see causes 3) and 4). → If causes 3) and 4) do not apply, check the transmission waveform and noise in the transmission line. For details about the check procedures, refer to the CITY MULTI (Outdoor Unit) Service Handbook.</p>

Error code	Description and method of detection	Cause	Check procedure and remedy
6606	<p>Communication error - Transmission processor communication error</p> <p>Failure with communication between the device processor on the board and the transmission processor.</p>	<p>1) Error that occurs when data was not transmitted normally due to an unexpected erroneous operation of the controller on which the error occurred.</p> <p>2) Failure of the controller on which the error occurred.</p> <p>3) Error due to abnormal data transmission due to a chance malfunction of the AHC ADAPTER.</p> <p>4) Defective AHC ADAPTER</p>	<p>Causes 1) and 2)</p> <p>Shut off the AC power of the AE-C/EW-C and then turn it back on.</p> <p>→ If the same error occurs again, the controller on which error occurred has failed.</p> <p>If the AE-C/EW-C has failed, replace the AE-C/EW-C.</p> <p>Causes 3) and 4)</p> <p>Cut the power supply from the unit (outdoor unit or power supply unit) that supplies power to AHC ADAPTER, or reset the error from the remote controller or centralized controller.</p> <p>→ If the same error recurs, AHC ADAPTER is defective.</p>
6607	<p>Communication error - No ACK return</p> <p>Error detected by the controller on the transmission side when there is no reply (ACK signal) from the other party after transmission.</p> <div data-bbox="280 909 600 1095" style="border: 1px solid black; padding: 5px;"> <p>* If recovery from the error is not possible with this check method and solution, refer to the service manual of the air conditioning unit.</p> </div>	<div data-bbox="624 674 943 741" style="border: 1px solid black; padding: 2px;"> <p>Occurrence source address: Outdoor unit</p> </div> <p>1) The transmission line of the centralized control terminal block (TB7) of the outdoor unit is disconnected or shorted.</p> <p>2) Power of the outdoor unit is shut off.</p> <p>3) The electric system of the outdoor unit has failed.</p> <p>4) When the address of the outdoor unit changes or is changed part way through or when the error occurred after normal operation was performed once, there are the following causes.</p> <ul style="list-style-type: none"> <li>• System abnormality - Total capacity error (7100)</li> <li>• System abnormality - Capacity code error (7101)</li> <li>• System abnormality - Connecting unit number excess (7102)</li> <li>• System abnormality - Address setting over 254 (7105)</li> </ul>	<p>a) Check causes 1) to 4). Fix the problem if you find the cause, and proceed to b) if you do not find the cause.</p> <p>b) Shut off the power of the AE-C/EW-C and then turn it back on. Fix the problem if you find the cause, and proceed to c) if you do not find the cause.</p> <p>c) Check whether or not an error has occurred by checking the remote controller or the LED for failure diagnosis on the outdoor unit. When there is an error → Fix the failed part in accordance with the details on the error code.</p>
		<div data-bbox="624 1413 943 1480" style="border: 1px solid black; padding: 2px;"> <p>Occurrence source address: Indoor unit</p> </div> <p>a) Error for only some indoor units.</p> <p>1) When the address of the indoor unit changes or is changed part way through.</p> <p>2) The transmission line of the indoor unit is defective or disconnected.</p> <p>3) The connector (CN2M) of the indoor unit is disconnected.</p> <p>4) The indoor unit controller has failed.</p>	<p>Turn off the power of the outdoor units and indoor units at the same time, leave it off for at least 5 minutes, and then turn it back on. Shut off the power of the AE-C/EW-C and then turn it back on.</p> <p>The equipment recovers normally if an unexpected error occurred. If it does not recover normally, check causes 1) to 4).</p>

Error code	Description and method of detection	Cause	Check procedure and remedy
6607		<p>b) All indoor units in one refrigerant system are in error</p> <p>5) Outdoor unit detects the error.</p> <ul style="list-style-type: none"> <li>• System abnormality - Total capacity error (7100)</li> <li>• System abnormality - Capacity code error (7101)</li> <li>• System abnormality - Connecting unit number excess (7102)</li> <li>• System abnormality - Address setting over 254 (7105)</li> </ul> <p>6) The transmission line of the centralized control terminal block (TB7) of the outdoor unit is disconnected or shorted.</p> <p>7) Power of the outdoor unit is shut off.</p> <p>8) The electric system of the outdoor unit has failed.</p> <p>9) The address switch of the outdoor unit is mistakenly set to 000 (00).</p>	<p>a) Check the failure diagnosis LED on the outdoor unit.</p> <p>→ When an error is occurring, perform a check in accordance with the details on the error code.</p> <p>→ When an error is not occurring, proceed to b)</p> <p>b) Check the details of causes 6) to 9).</p>
		<p>c) All indoor units are in error</p> <p>10) When a power supply unit for the transmission line is used, the power jumper (CN40) is inserted for supplying power to the centralized control transmission line of the outdoor unit.</p> <p>11) When outdoor units are used, the power jumper (CN40) is inserted for supplying power to the centralized control transmission line of multiple outdoor units.</p> <p>12) The transmission line power supply unit is disconnected or the power is shut off.</p> <p>13) The AE-C/EW-C has failed.</p>	<p>Check the voltage of the centralized control transmission line. (Voltage between A and B of TB3 in the case of the AE-C/EW-C)</p> <ul style="list-style-type: none"> <li>• When 17 V or higher → Check causes 5) to 11)</li> <li>• When less than 17 V → Check cause 12)</li> </ul>
		<div style="border: 1px solid black; padding: 2px;">Occurrence source address: Remote controller</div> <div style="border: 1px solid black; padding: 2px; margin-top: 5px;">Occurrence source address: System remote controller</div> <p>* Same as when the occurrence source is an indoor unit (Read that section and replace the term "indoor unit" with "remote controller" or "system remote controller")</p>	
	<p>Communication error - No ACK return</p> <p>Error detected by the controller on the transmission side when there is no reply (ACK signal) from the other party after transmission.</p>	<div style="border: 1px solid black; padding: 2px;">Address that should not exist</div> <p>An address that does not exist is set in the group registration, interlock LOSSNAY settings, or measurement settings of the AE-C/EW-C.</p>	<p>Check whether the address that does not exist in the system configuration is set in the group registration, interlock LOSSNAY settings, or measurement settings. If it is set, delete it.</p>

Error code	Description and method of detection	Cause	Check procedure and remedy
6608	<p>Communication error - No return of response frame</p> <p>When transmission was performed, there was an acknowledgment (ACK) to notify that the transmission was received from the other party but the response command was not returned.</p> <p>The transmission side detects an error 10 consecutive times at 3-second intervals.</p>	<ol style="list-style-type: none"> <li>1) When work was performed or the polarity was changed for the transmission line while the power was left on, the waveform changed and an error was detected when the transmission data collided.</li> <li>2) Transmission fails repeatedly because of, for example, noise.</li> <li>3) Attenuation of the transmission line voltage/ signal because the allowable range for the transmission line wiring has been exceeded. <ul style="list-style-type: none"> <li>• Farthest end: 200 m (656 ft) or less</li> <li>• Remote controller line: 10 m (32 ft) or less</li> </ul> </li> <li>4) Attenuation of the transmission voltage/ signal because mismatch of transmission line types. <ul style="list-style-type: none"> <li>• Wire diameter: 1.25 mm<sup>2</sup> or more</li> </ul> </li> <li>5) The set temperature range limit is set in a system with a remote controller that does not support the set temperature range limit connected.</li> </ol>	<ol style="list-style-type: none"> <li>a) When occurs during test run Turn off the power of the outdoor units, indoor units, and LOSSNAY at the same time, leave it off for at least 5 minutes, and then turn it back on. → If the equipment recovers from the error normally, the error was detected because transmission work was performed while the power was on. → If the error occurs again, proceed to b).</li> <li>b) Check causes 3) and 4). → If you find the cause, fix the problem. → If you do not find the cause, proceed to c).</li> <li>c) Check the transmission waveform and noise on the transmission line. Perform the check in accordance with &lt;Transmission waveform and noise check procedure&gt;.</li> </ol> <div style="border: 1px solid black; padding: 5px; margin: 5px 0;"> <p>If 6608 is occurring, it is very likely to be due to noise.</p> </div> <ol style="list-style-type: none"> <li>d) If the cause is not any of 1) to 4), check the system operating status and configuration. → If you find the cause, reset the remote controller.</li> </ol>
6920	<p>Communication error - No return of response frame</p>	<ol style="list-style-type: none"> <li>1) LAN contact failure.</li> <li>2) The power of the HUB is not on.</li> <li>3) The IP address has not been set.</li> <li>4) Is the length of the LAN cable 100 m (328 ft) or less?</li> <li>5) Is the transmission delay time 4 seconds or less round trip?</li> <li>6) The cloud service, if used, has detected a communication error.</li> <li>7) The IP addresses of the AE-C/EW-C have been changed.</li> </ol>	<p>Cause 1) Check that the LAN cables between the AE-C/EW-C and HUB are connected.</p> <p>Cause 2) Check that the power of the HUB is on.</p> <p>Cause 3) Check the IP address of the AE-C/EW-C.</p> <p>Cause 5) Check the communication state by pinging. For the ping check method, refer to "III [6] 2. About the check method using ping." If the ping is timed out, check the following.</p> <p>Cause 6) Refer to the instruction manual for the cloud service.</p> <p>Cause 7) Enter the changed IP address on the Initial Setting Tool, and re-send the settings.</p> <ul style="list-style-type: none"> <li>• Are LAN cables of category 5 or better being used?</li> <li>• Is there not connections to four or more layers using a gateway, router, etc.?</li> </ul>

Error code	Description and method of detection	Cause	Check procedure and remedy
6930	Modbus device communication error This error occurs when there is no response from the watt-hour meter connected via Modbus for a certain period of time.	<ol style="list-style-type: none"> <li>1) There is an abnormality in the connected signal cable.</li> <li>2) Terminating resistor is not properly connected.</li> <li>3) Modbus device name is incorrect.</li> <li>4) Communication settings are incorrect.</li> </ol>	<p>Cause 1) Check the connection between CN16 of the AE-C/EW-C and the Modbus watt-hour meter.</p> <p>Cause 2) Check that the terminating resistor is properly connected.</p> <p>Cause 3) Check the Modbus connection settings (Modbus number, address, and device name).</p> <p>Cause 4) Check the Modbus communication settings (transmission rate, stop bit, and parity bit).</p>
7106	System abnormality - Attribute setting error	<ol style="list-style-type: none"> <li>1) An address with a different attribute (air conditioning unit or other unit) is set for the group for which devices such as PI controller, chiller, and HWHP (QAHV) are set.</li> <li>2) The unit address set for the interlock source in the interlock LOSSNAY settings is not a LOSSNAY.</li> <li>3) The attribute (IC/FU) setting of the OA Processing unit is not correct.</li> </ol>	<p>Cause 1) Adjust the group configuration so that all addresses have the same attribute such as PI controller, chiller, and HWHP (QAHV).</p> <p>Cause 2) Change the address set for the interlock source in the interlock LOSSNAY settings to the correct address. Alternatively, delete it.</p> <p>Cause 3) Switch the attribute with the dip switch. For details, refer to the installation manual for OA Processing unit.</p>
7109	System abnormality - Connection setting error	<div style="border: 1px solid black; padding: 2px;">Occurrence source address: Chiller</div> <ol style="list-style-type: none"> <li>1) The group settings on AE-C/EW-C and the configuration and settings on the chiller do not match.</li> </ol>	Check the address registration of the group settings and the device configuration of the air-cooled chiller. If the address registration and the device configuration are different, review the address registration or the device configuration of the chiller.
		<div style="border: 1px solid black; padding: 2px;">Occurrence source address: HWHP(QAHV)</div> <ol style="list-style-type: none"> <li>1) The description of HW Supply on the AE-C/EW-C Initial Settings screen and the configuration and settings for HWHP do not match.</li> </ol>	Check the address registration of HW Supply and the device configuration of HWHP (QAHV). If the address registration and the device configuration are different, review the address registration.
7130	System abnormality - Different unit model error ALPHA2 program version mismatch error	<ol style="list-style-type: none"> <li>1) The ALPHA2 program was created and run without using the base program supplied with AHC ADAPTER.</li> <li>2) Version data has been overwritten in the base program supplied with AHC ADAPTER.</li> <li>3) The ALPHA2 base program used did not correspond to the AHC ADAPTER version.</li> </ol>	<p>Causes 1) and 2) Confirm that the ALPHA2 internal program uses the base program supplied with AHC ADAPTER. Check that the program version number matches the base program version number. =&gt; If not, recreate the ALPHA2 program from scratch using the base program supplied with AHC ADAPTER.</p> <p>Cause 3) (N/A as of April 2013)</p>
7905	Version error	<ol style="list-style-type: none"> <li>1) The software versions of AE-C/EW-C do not match.</li> </ol>	<p>Cause 1) Update all the connected AE-C/EW-C controllers to the version same as the software version.</p>

**NOTE:** When the error code is for a detection source other than AE-C/EW-C, refer to the service handbook or each air conditioning unit and perform the checks and take the corresponding measures.

**2. Error judgment based on the STATUS LED display of the AE-C/EW-C**

The AE-C/EW-C indicates its internal status with the STATUS LED.

The following table shows the LED lighting states, operating status, check methods, and solutions.

\* The LEDs are located on the lower left of the screen of the AE-C and on the left side of the front of the EW-C.

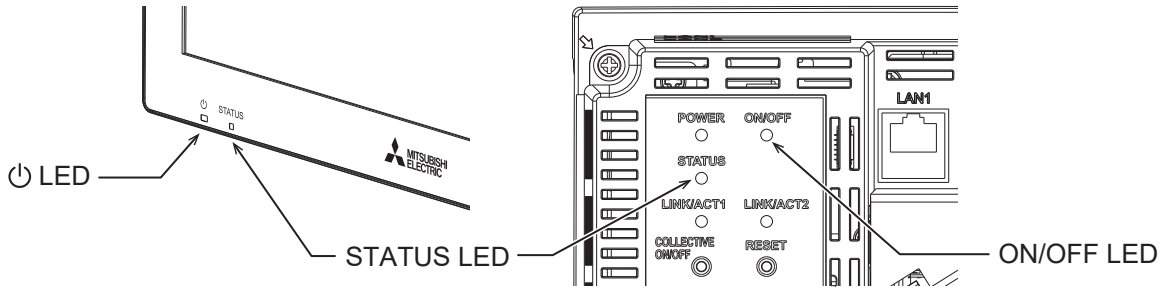

STATUS LED (Lighting color and state)		Operation status	Cause	Check procedure and remedy
Off	Normal	The equipment is operating normally.	-	-
	Error	(If using a cloud system) No communication with the cloud system	-	-
Blinking in blue	Normal	The software of the AE-C/EW-C unit is being updated.	-	The LED will turn off after the update completes. Please wait until the process completes.
Lit in blue	Normal	The update using the USB memory device has been completed successfully.	-	The LED stays lit in blue even after the update is completed. To turn off the LED, restart the controller.
Blinking in green	Normal	(If using a cloud system) Communication with the cloud system has been established, but the electric signal is weak.	-	If this symptom occurs frequently, it is recommended to install an external antenna.
Lit in green	Normal	(If using a cloud system) Communication with the cloud system has been established.	-	-
Blinking in pink	Error	The software update of the AE-C/EW-C unit failed.	<div style="border: 1px solid black; padding: 2px;">When updating the software using a USB memory device</div> <ol style="list-style-type: none"> <li>1) An error occurred because the update process could not be performed normally due to unexpected erroneous operation.</li> <li>2) The USB memory device is not inserted properly.</li> <li>3) The USB memory device is damaged.</li> <li>4) The USB memory device was removed and then reinserted within a short period of time.</li> <li>5) The AE-C/EW-C has failed.</li> </ol>	<ol style="list-style-type: none"> <li>1) Perform the update again.</li> <li>2) Check that the USB memory device is inserted properly.</li> <li>3) Connect the USB memory device to a PC or other device and check that the data inside it can be read correctly.</li> <li>4) Reset the power of the AE-C/EW-C and then perform the update again.</li> <li>5) If the update fails after resetting the power, the product is likely to have failed so replace it.</li> </ol>
			<div style="border: 1px solid black; padding: 2px;">When updating via the Web</div> <ol style="list-style-type: none"> <li>1) An error occurred because the update process could not be performed normally due to unexpected erroneous operation.</li> <li>2) The AE-C/EW-C has failed.</li> </ol>	<ol style="list-style-type: none"> <li>1) Check that the LAN cable is connected properly and then perform the update again.</li> <li>2) If the update fails after resetting the power, the product is likely to have failed so replace it.</li> </ol>

STATUS LED (Lighting color and state)		Operation status	Cause	Check procedure and remedy
Lit in pink	Error	The buzzer of the AE-C/ EW-C is sounding.	<ol style="list-style-type: none"> <li>1) R32 refrigerant leak has been detected.</li> <li>2) R32 refrigerant circuit inspection has been performed.</li> </ol>	<ol style="list-style-type: none"> <li>1) Take actions according to "4-5-1. R32 refrigerant gas leak detection screen" in the AE-C/EW-C. Instruction Book (Detailed operations).</li> <li>2) Take actions according to "4-5-2. Refrigerant gas leak error (during circuit inspection) screen" in the AE-C/EW-C Instruction Book (Detailed operations).</li> </ol>
Blinking in orange	Error	After the controller was started, an error has been detected in the internal microSD card 1.	<p>[microSD card 1 reading error]</p> <ol style="list-style-type: none"> <li>1) An accidental malfunction prevented writing to or reading from the internal microSD card 1.</li> <li>2) The internal microSD card 1 is disconnected.</li> </ol>	See "[15] microSD card replacement - Restore overview".
Blinking in yellow	Error	After the controller was started, an error has been detected in the internal microSD card 2.	<p>[microSD card 2 reading error]</p> <ol style="list-style-type: none"> <li>1) An accidental malfunction prevented writing to or reading from the internal microSD card 2.</li> <li>2) The internal microSD card 2 is disconnected.</li> </ol>	See "[15] microSD card replacement - Restore overview".
Blinking in light blue	Normal	Upon detection of the replacement of the microSD card, the controller is restoring data.	-	<p>Upon completion of the data restoration, the controller automatically restarts and resumes operation.</p> <p>*Data restoration takes up to 90 minutes.</p>
Blinking in red	Error	M-NET transmission line error	<ol style="list-style-type: none"> <li>1) M-NET power supply is redundant and is connected in wrong polarities.</li> <li>2) An abnormal voltage has occurred due to a short circuit in the M-NET transmission line, etc. while the power is being supplied from the AE-C/EW-C.</li> </ol>	<ol style="list-style-type: none"> <li>1) Check that the M-NET transmission line is not receiving power from multiple devices. If the power supply configuration is incorrect, correct it.</li> <li>2) Check the voltage on the M-NET transmission line. If no voltage is present, check the wiring work or transmission cables for any defects or short circuits.</li> </ol>

**3. Troubleshooting depending on the trouble symptoms of the AE-C/EW-C and trouble examples**

(1) AE-C/EW-C unit functions

	Symptom	Cause	Check procedure and remedy
1	The LCD remains off and no operation is possible.	1) AC power is not being supplied. 2) The AE-C has failed. (Internal power supply failure, etc.)	Cause 1) Check the voltage of the AC power supply terminal block of the AE-C. a) When 0 V → Check whether the circuit breaker connected to the AC power supply is ON. b) When 100 to 240 VAC → Proceed to cause 2) Cause 2) Shut off the AC power of the AE-C and then turn it back on. → If the same error occurs again, the AE-C has failed. Replace the AE-C.
2	The LCD screen turns on and off every few seconds and normal startup is not possible.	1) A software update of the AE-C did not end normally. 2) The AE-C has failed. (Internal connector contact failure, etc.)	Cause 1) Check the STATUS LED. → If it is blinking in pink, perform the software update again. Cause 2) If the cause is not cause 1) above, shut off the power and then turn it back on. If the same symptoms occur, the AE-C has failed. Replace the AE-C.
3	The LCD screen becomes red and a restart is performed repeatedly.	The AE-C has failed. (SDRAM failure, etc.)	The AE-C has failed. Replace the AE-C.
4	Prohibiting operation with the local remote controller does not work.	The M-NET remote controller is not registered to the group of the AE-C/EW-C.	Check whether the M-NET remote controller is registered to the group on the AE-C/EW-C, and if it is not, perform group registration for the M-NET remote controller.
5	The time is significantly different from the set time.	1) Incorrect setting from upper level equipment. 2) Incorrect setting from BACnet. 3) The AE-C/EW-C has failed.	Cause 1) Check the upper level equipment to see whether there is equipment for which the time is wrong. [Supplementary explanation] If the cause is not incorrect setting from upper level equipment, disconnect from the LAN and leave the equipment for one hour without a connection to the LAN and then check. Cause 2) Check that the time on the upper level equipment connected via BACnet is correct. → If the time is significantly slow (10 seconds or more per hour), the AE-C/EW-C has failed. Replace the AE-C/EW-C. Cause 3) AE-C/EW-C has failed. Replace the AE-C/EW-C.
6	Error output of the external output always continues to be ON even though an error has not been detected.	1) The power supply of the external circuit is connected with the polarity reversed. 2) AC power is applied to the external input. 3) The AE-C/EW-C has failed.	Cause 1) Check the polarity of the connection of the external power supply of the external circuit. If it is reversed, fix the polarity. If output is not normal even after changing the polarity, replace the AE-C/EW-C. Cause 2) and 3) Replace the AE-C/EW-C.

	Symptom	Cause	Check procedure and remedy
7	The unit icon remains in the starting up state and does not change.	A communication error is occurring.	The startup process will complete approximately five minutes after the power is turned on. After that, check the error code and remove the cause of the communication error. For the error codes detected by the centralized controller, refer to "III [4] 1. How to determine the cause and resolve trouble based on the detected error display of the AE-C/EW-C."
8	The initial settings data cannot be output to a USB memory device.	<ol style="list-style-type: none"> <li>1) The USB memory device is not inserted properly.</li> <li>2) There is no free space in the USB memory device.</li> <li>3) The USB memory device is not supported by the AE-C/EW-C.</li> <li>4) The USB memory device is damaged.</li> <li>5) The USB memory device was removed and then reinserted within a short period of time.</li> <li>6) Type A conversion adapter is used.</li> <li>7) The USB memory device contains data output by the Initial Setting Tool or initial setting data of other models.</li> <li>8) The AE-C/EW-C has failed.</li> </ol>	<p>Check causes 1) to 5). Take the measure corresponding to the cause.</p> <p>Cause 1) Check that the USB memory device is inserted properly.</p> <p>Cause 2) Check that there is free space on the USB memory device and free up space if necessary. (Minimum of 64 MB)</p> <p>Cause 3) Refer to "II [2] Equipment and materials required for service work."</p> <p>Cause 4) Try using another USB memory device.</p> <p>Cause 5) Restart the AE-C/EW-C (power OFF → ON).</p> <p>Cause 6) Use a Type C USB memory device, or replace the conversion adapter.</p> <p>Cause 7) If any of the following messages is displayed on the screen, save the initial setting data that are output from the controller to the USB memory device.</p> <ul style="list-style-type: none"> <li>• "Imported settings data are incorrect."</li> <li>• "The data backed up acquired from a different model cannot be imported."</li> <li>• "Another user is importing the settings data. Try again in a while."</li> </ul> <p>If the cause of the problem was none of causes 1) to 7), the AE-C/EW-C has failed. Replace the AE-C/EW-C.</p>
9	The charge parameters cannot be output to a USB memory device.	<ol style="list-style-type: none"> <li>1) The USB memory device is not inserted properly.</li> <li>2) There is no free space in the USB memory device.</li> <li>3) The USB memory device is not supported by the AE-C/EW-C.</li> <li>4) The USB memory device is damaged.</li> <li>5) The USB memory device was removed and then reinserted within a short period of time.</li> <li>6) The "Charge" license is not registered.</li> <li>7) The AE-C/EW-C has failed.</li> </ol>	<p>Check causes 1) to 6). Take the measure corresponding to the cause.</p> <p>For causes 1) to 5), check causes 1) to 5) for the item above.</p> <p>Cause 6) Check whether the apportioned electricity billing license is valid, and if it is invalid, register a license.</p> <p>If the cause of the problem was none of causes 1) to 6), replace the AE-C/EW-C.</p>

	Symptom	Cause	Check procedure and remedy
10	The date and time of the AE-C/EW-C are a date and time in the past.	1) The date and time were not set after installation. 2) If the power of the AE-C/EW-C is turned off after the power has been off for at least one week, the date and time will not have been retained. 3) An AE-C/EW-C was added to the system but its time was not set.	Cause 1) Set the current date and time on the date and time setting screen. Cause 2) When the power remains off for about one week, the date is returned to January 1st, 2022. (Supplementary explanation) The billing results will be affected in a system with a billing function, so set the current date and time on the date and time setting screen. Cause 3) The date at the initial startup becomes January 1st, 2022. Set the current date and time on the date and time setting screen.
11	Tapping the screen does not respond.	1) The screen was tapped with a gloved hand. 2) Failure of the AE-C.	Cause 1) Since the AE-C's touch panel is capacitive, tap it with bare hands. Cause 2) Failure of the AE-C. Replace the AE-C.
12	A floor plan cannot be read.	1) The USB memory device is not inserted properly. 2) A USB memory device that is supported by the AE-C is not being used. 3) The name of a file you are attempting to read is incorrect. 4) There are no files in the correct location in the USB memory device. 5) An attempt was made to load an image in an unsupported format. 6) The image size is not correct. 7) An attempt was made to load a file of unsupported size. 8) The USB memory device is damaged. 9) The USB memory device was removed and then reinserted within a short period of time. 10) The AE-C/EW-C has failed.	Check causes 1) to 8). Take the measure corresponding to the cause. Cause 1) Check that the USB memory device is inserted properly. Cause 2) Refer to "II [2] Equipment and materials required for service work." Cause 3) Set a correct file name as described in the Instruction Book. E.g.: floor_01.gif If [Hide extensions for known file types] is set in the folder settings of the PC on which the file was created, check the file name in the properties. Cause 4) Place the files in the root directory of the USB memory device. Cause 5) Load images in supported formats (gif, jpeg, jpg, or png). Cause 6) Create a file in gif format that is fixed to 3840 dots wide by 2160 dots high for each floor. Cause 7) For the file size that can be loaded, refer to the AE-C/EW-C Instruction Book (Detailed operations). Cause 8) Try using another USB memory device. Cause 9) Restart the AE-C/EW-C (power OFF → ON). If the cause of the problem was none of causes 1) to 9), the AE-C has failed. Replace the AE-C/EW-C.

	Symptom	Cause	Check procedure and remedy
13	The display of the read floor plan is strange in terms of size, colors, etc.	1) The size of the prepared images is incorrect. 2) The colors used in the prepared images are other than the specified ones. 3) Free software was used to create the gif images.	Cause 1) If the prepared images are enlarged or displayed tilted, the image sizes may be different than the designated 3840 dots wide by 2160 dots high. Check that the prepared images are the correct size. Cause 2) If the colors become different from those of the prepared images, check whether the images have been created using the colors specified in the instruction manual. Images with special effects, such as animated gifs, are not allowed. Cause 3) If free software is used to create the images, the format may differ from the standard gif format. If normal display is not possible, we recommend using the following software to create images. [Recommended software] Adobe® Photoshop®
14	Logged in to the initial setting screen but the setting buttons are in the pressed state and operation is not possible.	You are logged in as the administrator user so you do not have setting privileges.	Log in by entering the login name and password of the maintenance user.
15	The initial settings data cannot be read from a USB memory device.	1) The USB memory device is not inserted properly. 2) The SetupData folder does not exist in the USB memory device. Or the folder is incorrect. 3) A USB memory device that is supported by the AE-C/EW-C is not being used. 4) The USB memory device is damaged. 5) The USB memory device was removed and then reinserted within a short period of time. 6) Type A conversion adapter is used. 7) The AE-C/EW-C has failed.	Check causes 1) to 5). Take the measure corresponding to the cause. Cause 1) Check that the USB memory device is inserted properly. Cause 2) Check that the name of the folder containing the initial settings data is correctly set to SetupData (including uppercase and lowercase). Check that the period (.) in the IP address in the folder name has been replaced with an under-bar (_). Cause 3) Refer to "II [2] Equipment and materials required for service work." Cause 4) Try using another USB memory device. Cause 5) Restart the AE-C/EW-C (power OFF → ON). Cause 6) Use a Type C USB memory device, or replace the conversion adapter. If the cause of the problem was none of causes 1) to 6), the AE-C/EW-C has failed. Replace the AE-C/EW-C.

	Symptom	Cause	Check procedure and remedy
16	The displayed set temperature differs from the set temperature.	1) External temperature interlock control is set. 2) Peak cut control is being performed. 3) A schedule is set. 4) Interlock control is set.	Cause 1) If external interlock control is set, the set temperature is changed automatically according to the outdoor temperature. Check the external interlock control settings. Cause 2) If peak cut control is being performed, the temperature may change. Check the peak cut control settings. Cause 3) Check whether or not changing of the set temperature is registered in the schedule settings. Cause 4) Check whether or not changing of the set temperature is set in the interlock control.
17	Air conditioning units start operating on their own even though they are supposed to be stopped.	The setback function is set.	If the setback function is set to [Use], air conditioning units start performing the cooling or heating operation automatically when a set condition is met while the air conditioning units are stopped.
18	LOSSNAY units start operating on their own even though they are supposed to be stopped.	Night purge is set on the LOSSNAY units.	If the night purge setting is set on the LOSSNAY units, the operation to take in outside air is performed automatically according to the settings that are set on the LOSSNAY units.

	Symptom	Cause	Check procedure and remedy
19	A schedule does not operate.	1) Incorrect settings are set. 2) The period settings of the schedule are incorrect. 3) The [OK] button was pressed while the display area in today's schedule was still blank. 4) The current time is not correct. 5) The "Schedule" on the operation screen is set to <b>[Disabled]</b> . 6) A schedule is duplicated with the settings for a schedule with higher priority such as the yearly schedule. 7) The "Schedule/Season setting" in the advanced settings is set to <b>[Disabled]</b> .	Open the today's schedule screen of the group to be operated and check the set schedule is displayed. If it is not displayed, check causes 1) to 3) below. Cause 1) The schedule settings are retained for each group so check whether or not the schedule settings of the group you wish to operate are incorrect. Cause 2) One of the weekly schedules operates in accordance with the set period so check whether or not there is a mistake in the period settings of the season settings screen. Cause 3) If the [OK] button is pressed while the display in the today's schedule settings screen is left blank, the schedule is handled as having been set not to operate. If the settings of causes 1) and 2) are set correctly and a blank area is displayed when the today's schedule settings screen is opened, the cause is highly likely to be cause 3). Set the schedule to be operated again from the today's schedule settings screen. Cause 4) Check the current time. Cause 5) Change the setting to <b>[Enabled]</b> . Cause 6) The order of priority for schedules from highest to lowest is today's schedule, yearly schedule, weekly schedule 1, ..., weekly schedule 5. Cause 7) Set the "Schedule/Season setting" in the advanced settings to <b>[Enabled]</b> . For details, refer to AE-C/EW-C Instruction Book (Detailed operations).

Symptom		Cause	Check procedure and remedy
20	Error mail is not sent.	1) Incorrect settings are set. 2) Communication is cut off. 3) The mail is blocked by the mail server. 4) The mail is blocked by the incoming mail server.	Check causes 1) to 3) below. Cause 1) Check the mail address setting and SMTP server settings. For the setting procedures, refer to AE-C/EW-C Instruction Book (Detailed operations). Cause 2) Check the following items. <ul style="list-style-type: none"> <li>• Is the power of the HUB turned on?</li> <li>• Is the HUB broken?</li> <li>• Is the LAN cable disconnected?</li> <li>• Is the LAN cable 100 m (328 ft) or less?</li> <li>• Is a straight LAN cable of category 5 or better being used?</li> </ul> Cause 3) Port 25 (SMTP) (factory default setting) is used for sending mail of the AE-C/EW-C. Mail sent using port number 25 may be blocked by the mail server for security enhancement purposes. If it is blocked, sending will not be possible so consult with the information system administrator. Cause 4) The security settings required by the incoming mail server are not supported by AE-C/EW-C. After checking causes 1) to 4), check whether or not error mail is sent. Method: Register an unconnected indoor unit or local remote controller in the group registration screen of the AE-C/EW-C in order to generate an error and then check whether or not error mail is sent.
21	A buzzer sounds (continuous beeping sound) and the screen is not displayed after turning on the power of the unit.	The AE-C/EW-C has failed. (Internal power supply failure, etc.)	The AE-C/EW-C has failed. Replace the AE-C/EW-C.

	Symptom	Cause	Check procedure and remedy
22	<p>The set temperature is not reflected when the operation mode and set temperature are changed at the same time. Or the set temperature is not reflected when the operation mode and set temperature are changed at the same time in the schedule settings.</p>	<p>1) One of the following local remote controllers is connected to the air conditioning unit.</p> <ul style="list-style-type: none"> <li>• ME remote controller (model before PAR-U02MEDA and PAR-U01MEDU)</li> <li>• MA remote controller (model before PAR-31MAA(E))</li> <li>• MA remote controller (model before PAR-21MAA)</li> </ul> <p>2) The air conditioning unit is set to one of the following.</p> <ul style="list-style-type: none"> <li>• The set temperature is 18°C (64°F) or less in the "Heat" operation mode.</li> <li>• The set temperature is 29°C (84°F) or more in the "Cool" or "Dry" operation mode.</li> </ul> <p>3) The operation mode and set temperature change at the same time.</p> <ul style="list-style-type: none"> <li>* The operation mode changes from "Heat" to "Cool" or "Dry," or from "Cool" or "Dry" to "Heat."</li> <li>* The set temperature is set to an arbitrary temperature.</li> </ul>	<p>This symptom is likely when causes 1) to 2) are all met and multiple air conditioning units are operated at the same time from the centralized controller or system remote controller. Perform the check using the method described below.</p> <p>Cause 1) Confirm the model name printed on the local remote controller or from the supplied instruction manual.</p> <p>Cause 1) Display the operation screen and check the settings.</p> <p>Cause 2) Check the settings before the change and settings after the change in the operation screen.</p> <p>If this symptom occurred, the problem can be prevented by taking the following measure. If the operation mode is "Heat" for cause 2), change the setting for the set temperature to 19°C (66°F) or more, and if it is "Cool," change the setting for the set temperature to 28°C (82°F) or less.</p> <p>If schedule settings are used and the symptom occurred, the problem can be prevented by taking the following measure. If the operation mode is "Heat," set the schedule setting for the set temperature to 19°C (66°F) or more, and if it is "Cool," set the schedule setting for the set temperature to 28°C (82°F) or less before the time you wish to set in the schedule (five minutes before is recommended).</p> <p>Example: When wish to set to heating 26°C (79°F) at 8:00.</p> <p>7:55 Cooling 28°C (82°F) (schedule setting)</p> <p style="text-align: center;">↓</p> <p>8:00 Heating 26°C (79°F) (schedule setting)</p>

	Symptom	Cause	Check procedure and remedy
23	The temperature does not return to the original set temperature when control ends for setback control.	1) One of the following local remote controllers is connected to the air conditioning unit. <ul style="list-style-type: none"> <li>• ME remote controller (model before PAR-U02MEDA and PAR-U01MEDU)</li> <li>• MA remote controller (model before PAR-31MAA(E))</li> <li>• MA remote controller (model before PAR-21MAA)</li> </ul> 2) The setting is one of the following before setback control is executed. <ul style="list-style-type: none"> <li>• The lower limit temperature is 18°C (64°F) or less in the "Cool," "Dry," or "Auto" operation mode.</li> <li>• The upper limit temperature is 29°C (84°F) or more in the "Heat" or "Auto" operation mode.</li> </ul> 3) Setback control starts in one of the following states. <ul style="list-style-type: none"> <li>• Heating control that exceeds the lower limit temperature is started in the "Cool," "Dry," or "Auto" operation mode.</li> <li>• Cooling control that exceeds the upper limit temperature is started in the "Auto" or "Heating" operation mode.</li> </ul>	This symptom is likely when causes 1) to 3) are all met and setback controlled is used, perform the check using the method described below. Cause 1) Confirm the model name printed on the local remote controller or the model number from the supplied instruction manual. Cause 2) Display the operation screen and check the settings. Furthermore, check the upper limit temperature and lower limit temperature from the initial settings screen.  If this symptom occurred, the problem can be prevented by taking the following measure. In the winter season, set the operation mode to "Heat" before setback control is executed. In the summer season, set the operation mode to "Cool" or "Dry" before setback control is executed.
24	The set temperatures of all connected devices are 24°C (75°F).	1) The old model compatible mode setting was changed from disabled to enabled.	Cause 1) When the old model compatible mode is enabled, the set temperature for each mode changes to the temperature common to all modes. As a result, the symptom described on the left occurs. Set the temperature again when using the old model compatible mode.
25	The temperature settings for schedules disappeared.	1) The old model compatible mode setting was changed from disabled to enabled, and enabled to disabled.	Cause 1) When the old model compatible mode is enabled, the set temperature for each mode changes to the temperature common to all modes. As a result, the symptom described on the left occurs. Set the schedule settings again when using the old model compatible mode.
26	A tree icon appears.	1) Demand control is operating. 2) High sensible heat control is operating. 3) Contact demand of the outdoor unit is operating. 4) Contact demand of the indoor unit is operating. 5) Energy-saving control is performed with a local remote controller. 6) ET control is operating.	Causes 1) to 5) This icon appears when the energy-saving control is operated. Check the settings for each operation. Cause 6) This icon appears when the ET control is operated. To hide the display, change the setting to [Disabled].

(2) Web browser for AE-C/EW-C

	Symptom	Cause	Check procedure and remedy
1	Display by the Web browser is not possible.	<p>LAN communication error.</p> <p>The LAN cable connector is disconnected or the connection is incorrect.</p> <p>The IP address and subnet mask settings are incorrect.</p> <p>The gateway address setting is incorrect.</p> <p>LAN communication equipment (HUB or router) has failed. LAN cable disconnected or contact failure.</p> <p>IP address of LAN1 and the IP address of LAN2 of the AE-C/EW-C (for exclusive use with BACnet) are the same.</p> <p>Other than the login page is registered in Favorites of the web browser.</p> <p>A Web browser setting is incorrect.</p> <p>The AE-C/EW-C is not registered as an exception in the proxy server settings.</p>	<p>Enter the following in the command prompt on the PC, press the [Enter] key, and check the response.</p> <p><b>Ping</b> [IP address of AE-C/EW-C]                      E.g.: ping 192.168.1.1 (IP address of PC: 192.168.1.101)                      If communication was successful, the reply is as follows.  <b>Reply from 192.168.1.1: bytes=32 time=1 ms TTL=64</b>                      If the LAN cable is not connected or the IP address setting is incorrect, the reply is as follows.  <b>Request timed out.</b>                      If the subnet mask, gateway, or other network setting is incorrect, the reply is as follows.  <b>Reply from 192.168.1.250: Destination host unreachable.</b></p> <p>Insert the connector of the LAN cable properly into the LAN port at the back of the AE-C/EW-C.                      Furthermore, old types of HUBs have two port types, one for a terminal connection and one for a HUB connection, so check whether or not the LAN cables of the AE-C/EW-C and PC for the browser are connected to ports for terminal connections.</p> <p>Unless other specified, set the IP address as follows.                      AE-C/EW-C: <b>192.168.1.1 to 192.168.1.40</b>                      PC for browser: <b>192.168.1.101 to 192.168.1.149</b>                      Set the subnet mask to <b>255.255.255.0</b>.</p> <p>If a router is connected to the network, the gateway address needs to be set on the AE-C/EW-C.                      Set the IP address of the router to which the AE-C/EW-C will be connected as the gateway address.</p> <p>If a connection error reply is returned for the ping command even after checking the various settings above, the cause is probably a failure of the LAN communication equipment (HUB or router) or a defect of the LAN cable itself.                      Replace the HUB or other communication equipment or the LAN cable and then perform a connection check.</p> <p>Using the Initial Setting Tool, change the IP address of LAN2 of the AE-C/EW-C. Alternatively, change the IP address of LAN1.</p> <p>Register the login page to Favorites of the a browser.</p> <p>If a Web browser setting is incorrect, the Web screen of the AE-C/EW-C may not be able to be displayed at all even if a response to the ping command could be received normally.                      If the Web screen is not displayed at all, check the following setting.</p> <p>In the case of a PC with Internet access that is installed in an internal LAN or the like, a proxy server may be set.                      If a proxy server is set, enter the IP address of the AE-C/EW-C in the exception field to enable a connection that is not via the proxy server.</p>
2	Display by the Web browser is not possible using the HTTPS (SSL) protocol.	LAN communication error.	Check the same items as "LAN communication error" and "A Web browser setting is incorrect" of "Display by the Web browser is not possible."

Symptom		Cause	Check procedure and remedy
3	Initial setting data cannot be loaded from the PC.	1) LAN communication error. 2) The USB memory device contains data output by the Initial Setting Tool or initial setting data output by other models. 3) Failure of the AE-C/EW-C.	Cause 1) Check for LAN communication errors between the controller and the PC. Cause 2) If any of the following messages is displayed on the screen, use the initial setting data that are output from the controller. <ul style="list-style-type: none"> <li>• "Imported settings data are incorrect."</li> <li>• "The data backed up acquired from a different model cannot be imported."</li> <li>• "Another user is importing the settings data. Try again in a while."</li> </ul> If neither Cause 1) nor Cause 2) applies, the cause is a failure of the AE-C/EW-C. Replace the AE-C/EW-C.

### [5] M-NET transmission waveform and noise check procedure

The AE-C/EW-C performs control while signals are exchanged between AE-C/EW-C, outdoor units, indoor units, and remote controllers (M-NET remote controllers) through M-NET. The interference of noise or the like on the transmission line will cause normal transmission to no longer be possible and erroneous operation.

(1) Symptoms caused by the interference of noise on the transmission line

Cause	Malfunction	Error code	Error description
Interference of noise on the transmission line	The signal is transformed and is mistaken as a signal from a different address.	6600	Communication error - Address duplicate
	The sent waveform is transformed due to noise and the other party cannot receive the signal normally leading to no acknowledgment (ACK).	6607	Communication error - No ACK return
	The state of being unable to send continues due to small noise interference.	6603	Communication error - Transmission line busy
	Sending is successful but the acknowledgment (ACK) or the response is not returned normally due to noise.	6607 6608	Communication error - No ACK return/No return of response frame

(2) Waveform check procedure

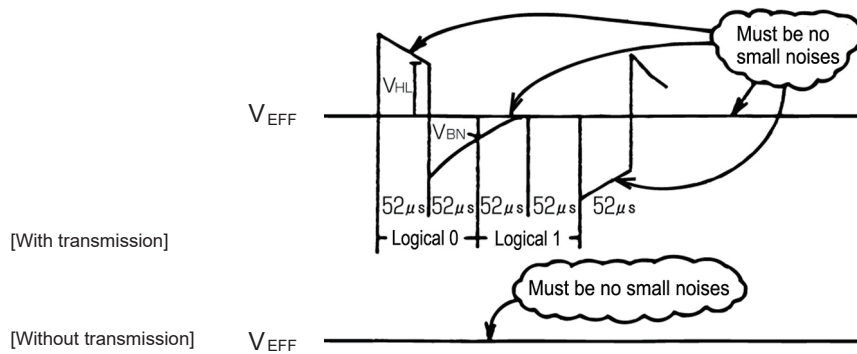

Waveform check procedure

Check the waveform of the transmission line with an oscilloscope. The following conditions must be met.

- There must be no small waveform (noise) in the transmission signal.  
(Small noise of approximately 1 V caused by the operation of a DC-DC converter or inverter may be noticeable but such noise should not be a problem when the unit and transmission line shield are grounded.)
- The voltage level of each portion of the transmission signal must be as follows.

Logic	Transmission line effective voltage level	Transmission line signal voltage level
0	$17\text{ V} \leq V_{\text{EFF}} \leq 32\text{ V}$	VHL = 2.5 V or higher
1		VBN = 1.3 V or lower

[Supplementary explanation] Oscilloscope settings

- Band with 300 MHz or higher
- V/div: 2.0 V/div with AC coupling
- T/div: 20 to 100 μs/div

(3) Check and solution

If noise is confirmed in the waveform or any of the errors of the error codes in (1) occur, perform the following checks.

	Error description	Action
Wiring method check	1. Are the transmission line and power cable (100—240VAC) routed together?	Lay the power cable as far away as possible. When laying the cables over a long distance, provide a space of at least 5 cm between them. In particular, do not insert them in the same conduit.
	2. Is the transmission line bundled together with the transmission line of another system?	Lay the transmission line so that it is separate from other transmission lines. When it is bundled with another transmission line, there is the risk of erroneous operation.
	3. Is the specified cable being used for the transmission line?	Use the specified transmission line. Transmission line type: CVVS/CPEVS/MVVS shielded cable (for M-NET remote controller) Transmission line diameter: At least 1.25 mm <sup>2</sup> (Remote controller wire: 0.3 to 1.25 mm <sup>2</sup> )
	4. When the transmission line is daisy-chained on the indoor unit terminals, is the shield daisy-chained too?	The two wires of the transmission line are daisy-chained. The shield must also be daisy-chained in the same way as the transmission lines. If the shield is not daisy-chained, its effect on reducing noise will be small.
	5. Is the transmission line grounded with the earth?	Prevent parts from being grounded with the earth.
	6. Is the transmission line connected to the junction terminals properly?	If bare wires are twisted together, connect the wires properly by, for example, crimping them together.
Grounding method check	1. When the transmission line is daisy-chained, is the shield daisy-chained too?	Ground one point of the shield at a unit that supplies power. If no grounding is provided, the noise on the transmission line cannot escape so there is the risk that the transmission signal will be transformed.
	2. Check the treatment method of the shield of the transmission line (for centralized control).	The transmission line for centralized control is less susceptible to noise interference if it is grounded from one outdoor unit in the case of group operation between units with different refrigerant or from the system controller in the case of using a system controller. However, the environment against noise varies depending on the distance of the transmission lines, the number of the connected units, the type of the controllers to be connected, and the environment of the installation site, so check that the transmission line work for centralized control has been performed as follows. a) When not grounded <ul style="list-style-type: none"> <li>• Group operation between units with different refrigerant Grounded at one outdoor unit (power supply unit)</li> <li>• Using system controller Grounded at a power supply unit (including a system controller with a built-in power supply)</li> </ul> b) When an error occurs even though grounded at one point Ground the shield at all outdoor units and power supply units (including system controllers with a built in power supply)

If the peak value is low, if a 66xx error occurs, or if the remote controller remains in the initial screen display state

Error description	Action
1. The distance to the farthest end of transmission line exceeds 200 m (656 ft).	Check that the distance from the outdoor unit or power supply unit to the indoor unit and to the remote controller at the farthest end is 200 m (656 ft) or less.
2. The types of transmission lines differ.	Use the specified transmission line. Transmission line type: CVVS/CPEVS/MVVS shielded cable Transmission line diameter: At least 1.25 mm <sup>2</sup> (remote controller wire: 0.3 to 1.25 mm <sup>2</sup> )
3. Outdoor unit board failure	Replace the outdoor unit control board or transmission power supply board.
4. Indoor unit or remote controller failure	Replace the indoor unit control board or remote controller.
5. The MA remote controller is connected to the M-NET transmission line.	Connect the MA remote controller to the MA remote controller terminal block (TB15) on the indoor unit control board.

**NOTE:** For details on the restrictions on wiring length, refer to the AE-C/EW-C Technical Manual.

## [6] LAN communication error check procedure

This section describes how to check and resolve trouble when the equipment does not operate normally and there are symptoms related to a LAN communication error such as when an error code for a LAN communication error is displayed and Web browser display is not possible.

[About the required equipment]

The following lists the equipment required for the check when there are symptoms related to a LAN communication error.

- PC
- LAN cable...Several straight cables (category 5 to 6e)
- Switching HUB...100BASE-TX

### 1. About the preliminary check items

If the equipment is not operating normally and there are symptoms related to LAN communication, first recheck the following items.

- AE-C/EW-C: 6920 or 0097 (when using billing function) is displayed

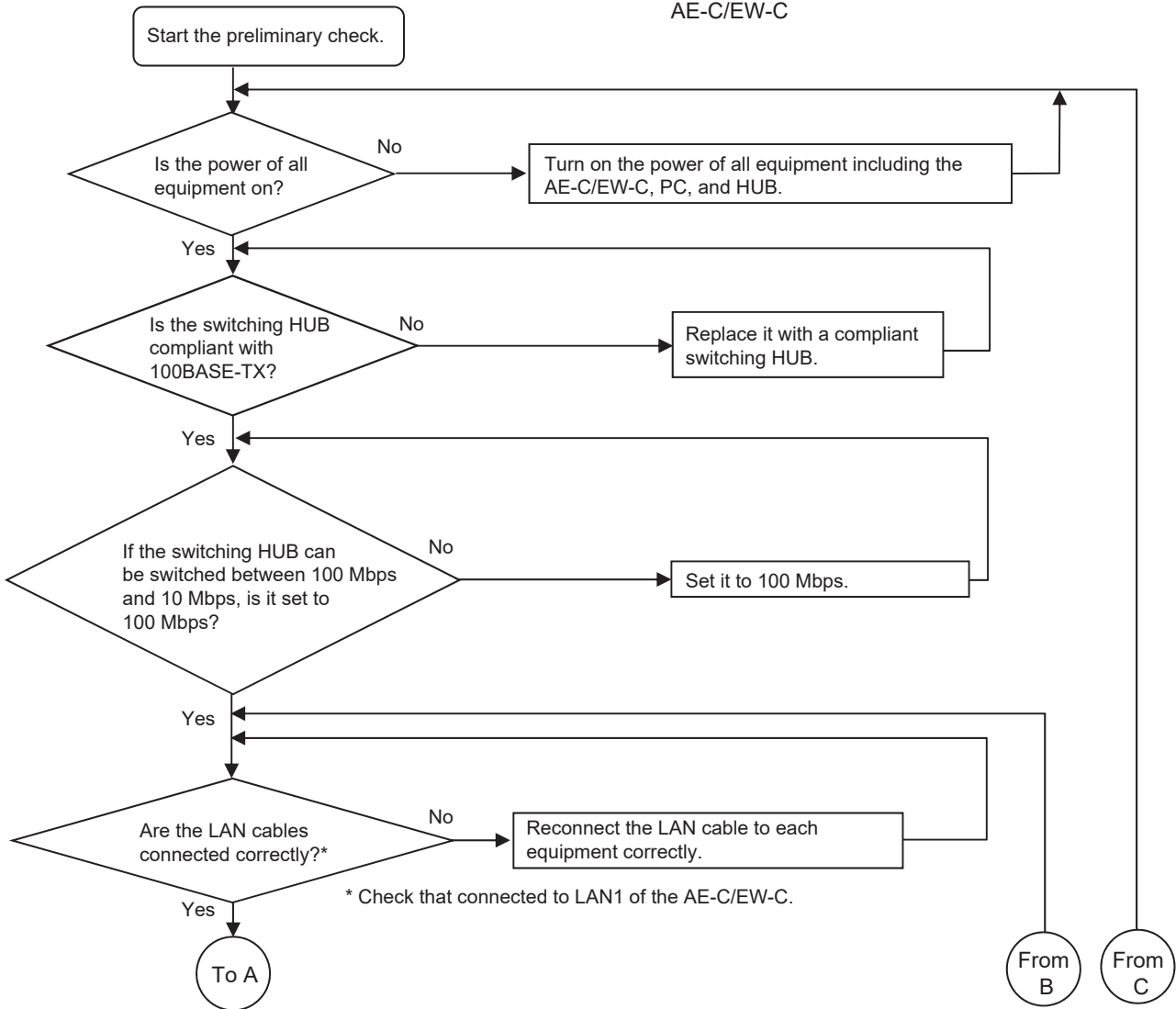
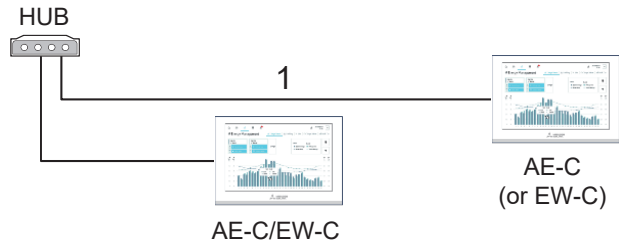

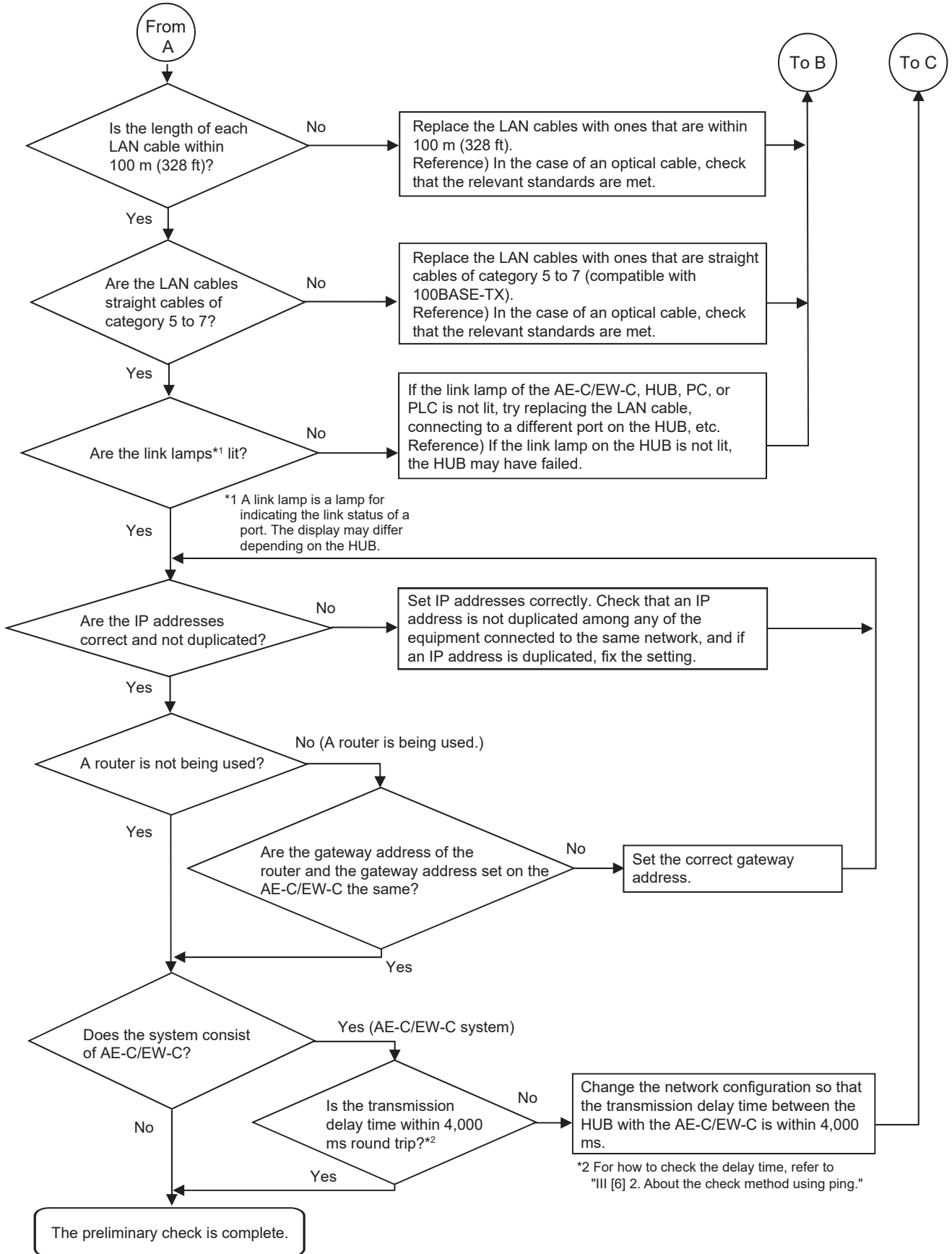

**If you answered "No" for any of the above items, first remove the cause of that item and then check if the symptoms persist.**

However, try your best to not turn on and off the power of the target devices (AE-C/EW-C and PLC) many times. If the symptoms still persist, refer to "III [1] Before performing failure diagnosis" and then perform the checks.

**[How to check the IP address of the AE-C/EW-C]**

Check the IP address setting of each equipment to confirm that there is not a duplicate IP address set for equipment connected to the same network.

\* This procedure is not possible with BACS-AP50.

(1) How to check IP address of the AE-C unit

The IP address of the AE-C can be checked in [Initial Settings] - [Network] screen.

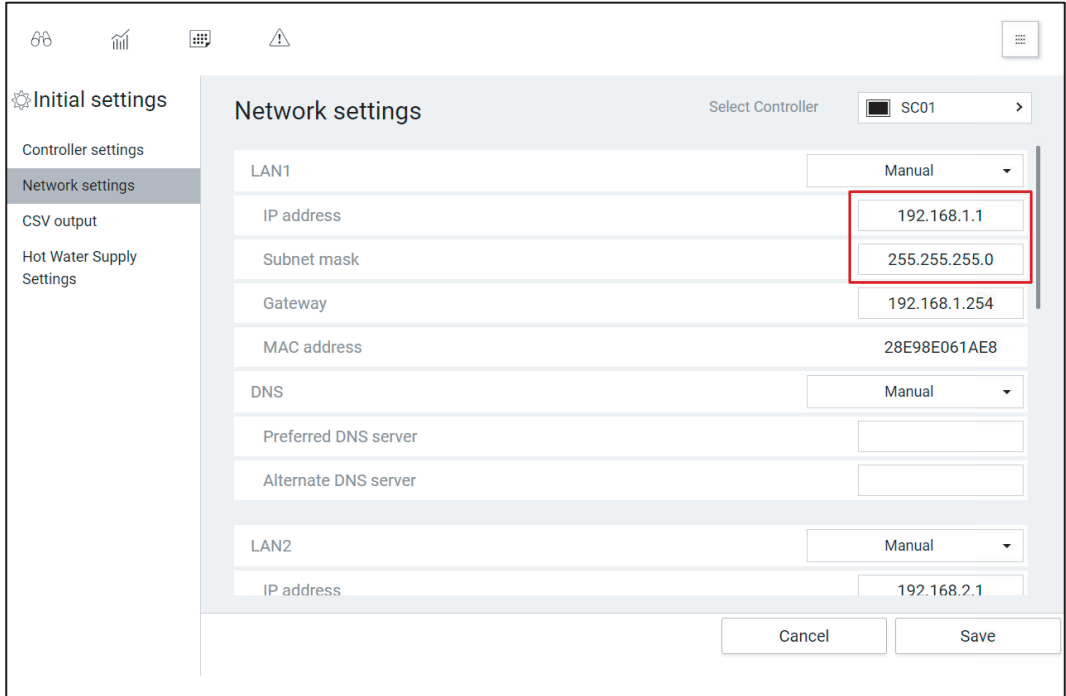

(2) How to check the IP address of the EW-C on the LCD screen of the AE-C

Select [Initial settings] - [Network setting] screen, and then select the AE-C/EW-C connected to the LAN in the Select Controller box to check the IP address.

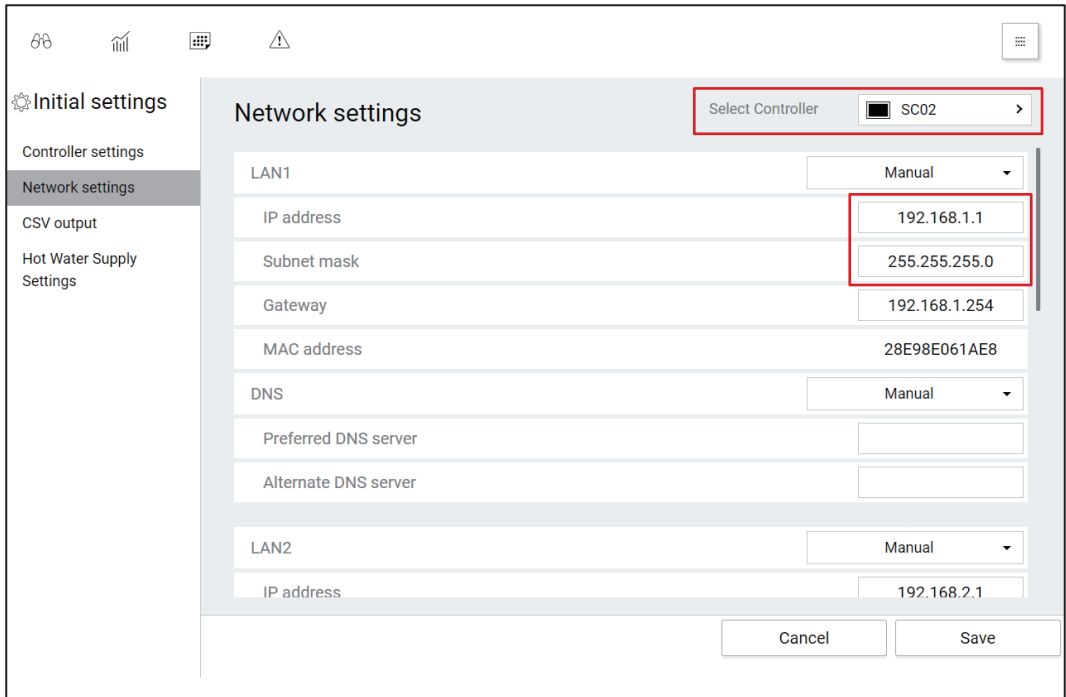

## 2. About the check method using ping

### (1) Notes

**This section contains notes on performing a check. Read them before you perform a check.**

- 1) Be sure to obtain the permission of the network administrator to connect a PC to the network for the check and also check that the IP address is one that it is alright to use.
- 2) Set the IP address of the PC for the check to one that is suitable for the network. (When a router or other equipment is used, also set the gateway address.)
- 3) If you cannot use the PC that you brought with you, ask the network administrator if there is a PC that you can borrow.

### (2) About the check item using ping

Use a PC to check the communication status of equipment for which a communication error is occurring between equipment.

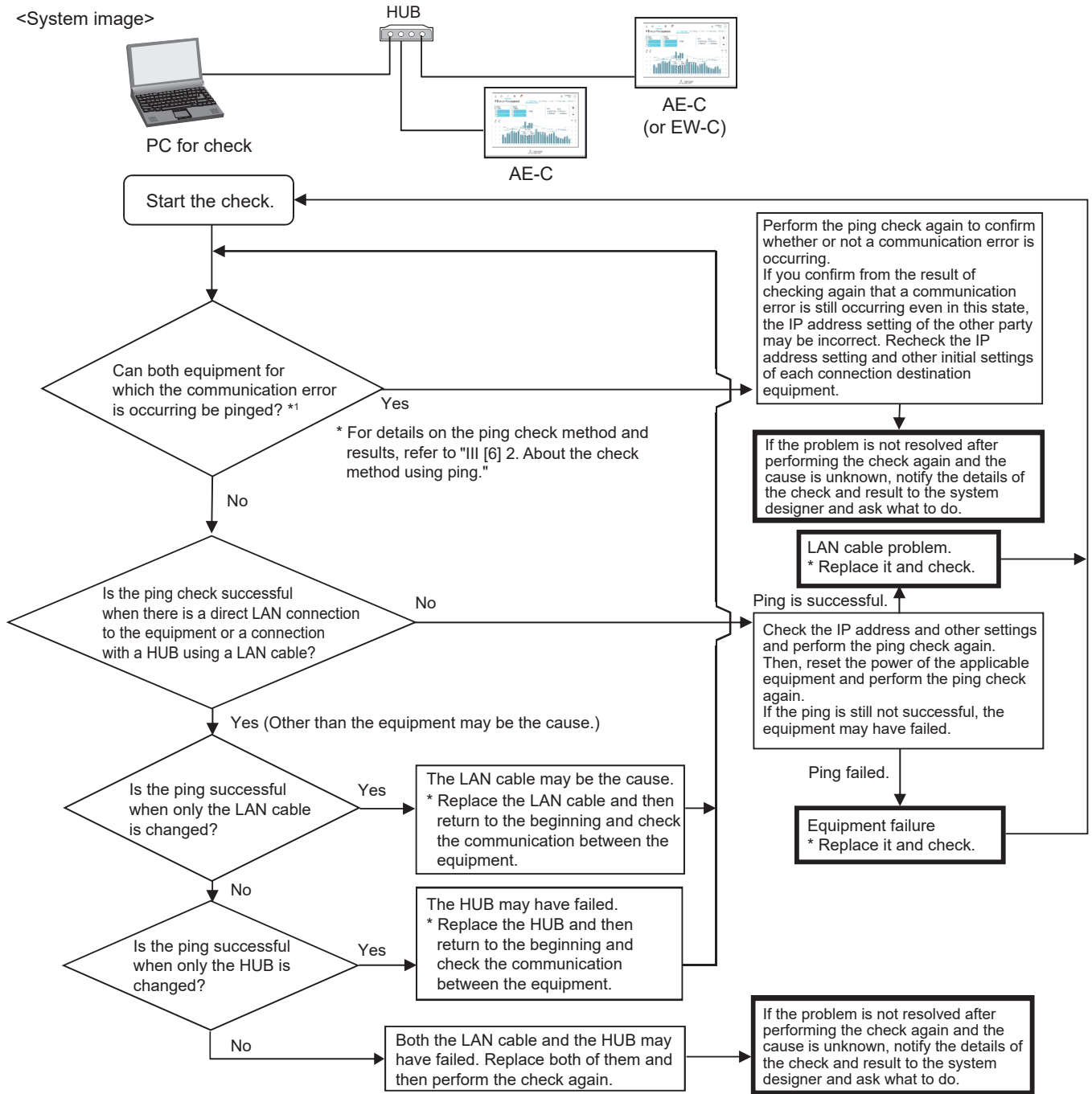

**[Ping check method]**

Ping the AE-C/EW-C, etc. from the command prompt of a PC.

How to display the command prompt (Windows 11)

From the Windows start menu, select "All Apps" to open "Windows Tools," and select "Command Prompt."

Run the following in the command prompt.

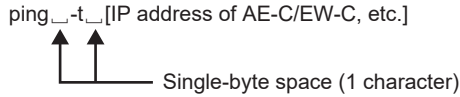

[Example] ping -t 192.168.1.1

Check that the connection was successful from the message displayed when the command was run.

To quit ping, press the Ctrl and C keys on the keyboard at the same time.

<Result when could be pinged (example when successful)>

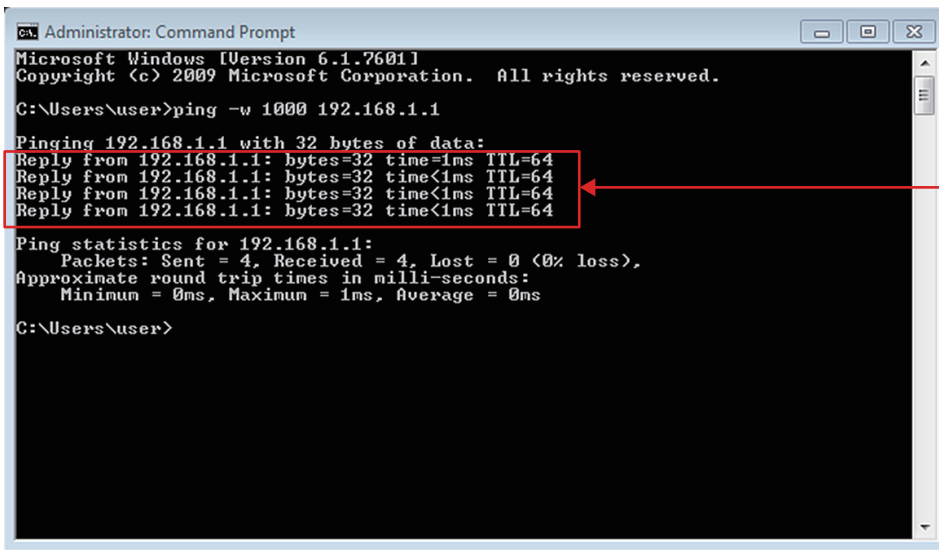

Response if the connection is successful. Included in the response are the following:

- Number of bytes: Received data length
- Time: Delayed time
- TTL: Time To Live (amount of times that data pass through a router)

<Result when could not be pinged (example when failed)>

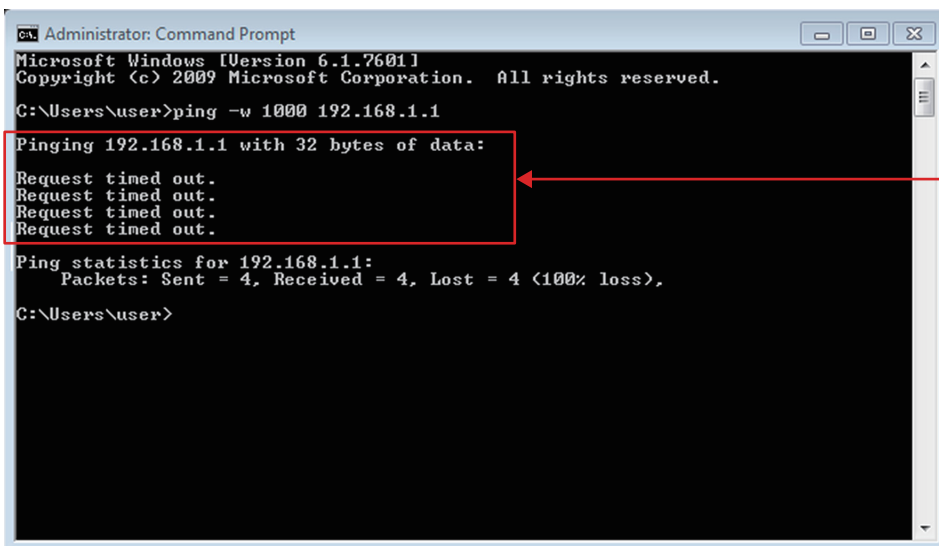

If "Request timed out." is displayed, recheck the LAN connection status, IP address, etc.

(Supplement)  
The response to pings may be irregular depending on the equipment. If there is no response after continuing pinging for a certain time, quit ping by pressing the Ctrl and C keys.

**[How to check when a LAN communication error occurs in a system connected via a router (how to isolate the cause)]**

When LAN communication is not performed properly (pinging is not successful\*1) in a system connected using a router, you can isolate the cause as follows.

\*1 Check whether pinging the AE-C/EW-C from a PC is successful when there is a connection via a router in advance.

Step	Method	Supplement
1	Prepare a PC that is connected to the same network. Use a PC in the same network with no connection via the router.	If there is no PC connected to the network, identify an IP address that it is alright to use and then connect a PC with that IP address set.
2	<p>Ping the AE-C/EW-C or other target equipment from the PC. Run the following in the command prompt.</p> <pre>ping _ _ -t _ [IP address of target equipment]</pre> <p style="margin-left: 40px;">↑    ↑ Single-byte space (1 character)</p> <p>[Example] ping -t 192.168.1.1</p> <p>→ <u>When pinging is successful:</u> There may be a problem with the gateway setting of the target equipment or the router settings. Consult with the equipment administrator. For the gateway address setting, refer to the AE-C/EW-C Instruction Book (Detailed operations) / "9-2. System settings" in BACS-AP50 Instruction Book (Detailed operations). For the router settings, check the Instruction Book of the router.</p> <p>→ <u>When pinging failed:</u> There may be a problem with the IP address setting of the target equipment. Check the setting. If the problem still cannot be resolved, there is likely to be a problem with the network of the router. Consult with the system administrator.</p>	* For the operating procedure, refer to [Ping check method] on the previous page.

**[How to check that an IP address is not duplicated]**

If it is not possible to check the IP addresses of all equipment, there is the following method using a PC to check with the command prompt.

(Supplement) If all connected equipment in a system in an existing network cannot be checked, you can compare the MAC addresses of the equipment of only the air conditioning control system to check if an IP address is duplicated.

Step	Method	Supplement
1	Prepare a PC that is connected to the network.	If there is no PC connected to the network, identify an IP address that it is alright to use and then connect a PC with that IP address set.
2	Ping the IP address of the AE-C/EW-C from the PC while the AE-C/EW-C is disconnected from the LAN. If there is a response, there is equipment with the same IP address as the AE-C/EW-C. Consult with the network administrator.	

## [7] Peak cut troubleshooting

The following shows troubleshooting for the peak cut function.

\* Before carrying out troubleshooting, check whether or not the peak cut settings have been configured.

	Item	Yes	No
1	Are the block settings configured?		
2	Are the peak cut settings configured?		
3	Is the license registered to each AE-C/EW-C?		

→ If “No” was answered for any of the above, the cause is likely to be that item. First remove that cause.

### (1) Troubleshooting based on trouble examples

	Symptom	Cause	Check procedure and remedy
1	The peak cut control status does not match on the actual equipment and the AE-C/EW-C (Web browser) screen. (Display timing offset)	There is a difference in the monitor timing.	- (Normal) → An offset occurs due to the monitor timing.
2	It is hot as cooling has no effect due to peak cut.	1) Control is always at the highest level because the set peak cut power value is low.	Check how low the peak cut level is set (*1) and if it is low, do the following. Cause 1) Consider whether the peak cut level can be changed. *1 The level can be checked in the [Energy Mgmt] - [Peakcut] screen on the AE-C LCD.
3	Peak cut control is not being performed normally.	1) The license is not registered to the AE-C/ EW-C. 2) The power of the AE-C/ EW-C, PI controller, PLC is shut down. 3) The M-NET transmission line or a LAN cable is broken or disconnected. 4) The operation block is not set. 5) The control settings of peak cut control are not set or the settings are incorrect. 6) There is a pulse setting mistake (in the case of a PI controller). The pulse unit is set on the PI controller even though it is connected with the AE-C/EW-C.	Check causes 1) to 7). Take the measure corresponding to the cause. Cause 1) Register the energy management license pack to the AE-C/EW-C. Cause 2) Check the power supply system. Cause 3) Check the connections of the M-NET transmission line and LAN cables. Cause 4) Set the operation block and configure the peak cut control settings. Cause 5) Check and fix the settings. Cause 6) Check that the [kWh/pulse] setting on the electricity meter and PI controller is correct. When the PI controller is connected with the AE-C/EW-C, dip switch SW02 of the PI controller needs to be set to the SC setting (factory default setting). If there is setting mistake, fix it.

## [8] Energy management troubleshooting

The following shows troubleshooting for energy management

\* Before carrying out troubleshooting, check whether or not the energy management settings have been configured.

	Item	Yes	No
1	Are the external temperature sensor settings configured?		
2	Is apportioning mode of the indoor unit set?		
3	Are the settings of the apportioning source electricity meter of the indoor unit configured?		

\* For the setting procedures, refer to the Instruction Book (Detailed operations).

→ If “No” was answered for any of the above, the cause is likely to be that item. First remove that cause.

Symptom	Cause	Check procedure and remedy
1 Bar graphs and line graphs are not displayed.	1) There are required items for display that is not set. 2) There was a power failure so management data does not exist for that period. 3) The data is damaged.	Check method and process <pre>                     graph TD                         Q1{Are setting fields empty in the screen of the pressed display selection button?}                         Q2{Did a power failure occur?}                         R1[Select the button of the empty fields and configure the settings.]                         R2[There is no failure. Energy management data cannot be collected during a power failure.]                         R3[The AE-C/EW-C may be broken.]                          Q1 -- Yes --&gt; R1                         Q1 -- No --&gt; Q2                         Q2 -- Yes --&gt; R2                         Q2 -- No --&gt; R3                     </pre>
2 The target values are not displayed.	1) The display unit is other than "Block." 2) The target values are not set. 3) The settings of the apportioning source electricity meter of the indoor unit are not configured.	Check causes 1) to 3). Take the measure corresponding to the cause. Cause 1) Touch [Display switching] to change the display unit to [Block]. Cause 2) Go to the [Energy Mgmt] - [Target value] screen and set the target values. For details, refer to "III [6] 2. About the check method using ping". Cause 3) Select the electricity meter in [Indoor unit electricity meter] of the Energy Management Settings screen of Initial Setting Tool.
3 [OK] cannot be pressed after setting the target values.	The total of the percentages is not 100%.	Adjust the percentages based on the red indication at the bottom of the setting screen.

## [9] Troubleshooting for apportioned electricity billing function

The following shows troubleshooting for the apportioned electricity billing function.

\* Before performing the troubleshooting, read "[1] Before performing failure diagnosis" and "[4] Troubleshooting and solutions depending on the equipment" in Chapter III.  
 Also, check whether the initial settings related to billing have been configured from the Initial Setting Tool.

Item		Yes	No
1	Initial Setting Tool	Are the refrigerant system settings configured?	
2		Are the operation block and energy management block settings configured?	
3		Are the billing settings configured?	
4	Charge Calculation Tool	Are the advanced settings configured?	

→ If you answered "No" to any of the above, the item may be the cause of the failure.

Check the setting items below to see if there is any error. If there is an error, correct it.

[Legend] ○: Applicable, -: Not applicable

Check item			Check required/not required		Check result	
			Electric energy metering-device (meter) method	Electric energy manual entry (no meter) method	Good	NG
1	Initial Setting Tool	Refrigerant system settings	○	○		
2		Operation block settings	○	○		
3	(Unit settings)	Energy management block settings	○	○		
4		PI controller settings	○	-		
5	Initial Setting Tool	Billing settings	○	○		
6	(Billing settings)	Outdoor unit settings (standby power)	○	-		
7		Indoor unit settings (Cooling capacity, FAN power consumption, standby power)	○	○		
8		Measurement settings (unit to be connected to the meter)	○	-		
9		Charge settings	○	○		
10	Charge Calculation Tool (Advanced settings)	Charge calculation advanced settings	○	○		

(1) Troubleshooting based on trouble examples

Symptom		Cause	Check procedure and remedy
1	The charge calculation results show that the total output values of the energy management block do not match the total values of the electricity meter.	If the difference is small: 1) Normal  If the difference is large: 2) Check the causes of Symptom 4.	The values for electric energy are rounded off to two decimal places, and the digits after the decimal point are rounded down from the values for the charge. This may result in a mismatch between the total values of the block and electricity meter.
2	The charge calculation results show that the values of the electricity meter and the actual electricity meter do not match.	If the difference is small: 1) Normal  If the difference is large: 2) Setting error of pulse unit	Cause 1) An error occurs because the value is rounded off to two decimal places. A difference from the actual electricity meter also occurs due to the pulse input timing.  Cause 2) Check that the pulse unit [kWh/pulse] settings on the electricity meter are correct. If there is a setting error, correct it.
3	The charge calculation results show that the value of the electricity meter is "0."	1) Setting error of the pulse value in the PI controller settings. 2) Setting error of the Dip switch on the PI controller	Cause 1) Correct the settings. Cause 2) Turn on the Dip switch SW01 on the PI controller.  * Charges cannot be apportioned correctly if there is an error in these settings. When changing or adding a meter, be sure to configure the settings before use.
4	The amounts of charge for some energy management blocks are large.	1) Setting error of the refrigerant system 2) Setting error of the energy management block 3) Setting error of the cooling capacity/FAN consumption power in the indoor unit settings 4) Setting error of the connection unit in the measurement settings 5) Setting error of the charge time period 6) Setting error of the unit price (yen/kWh)	Check causes 1) to 6).  Correct the error and resolve the problem according to the causes shown in the analysis results. Causes 1) to 5) After correcting the settings and performing remedial apportionment, recalculate the amounts using the Charge Calculation Tool. Cause 6) Make corrections and perform recalculation using the Charge Calculation Tool.
5	The charge calculation results for all blocks are 0 yen or the display is blank.	1) Setting error of the refrigerant system 2) Setting error of the energy management block 3) Setting error of the cooling capacity/FAN consumption power in the indoor unit settings 4) Setting error of the charge time period 5) Setting error of the unit price (yen/kWh) 6) The license for the apportioned electricity billing function is not registered to the all controllers.	Check causes 1) to 6).  Correct the error and resolve the problem according to the causes shown in the analysis results. Causes 1) to 4) After correcting the settings and performing remedial apportionment, recalculate the amounts using the Charge Calculation Tool. Cause 5) Make corrections and perform recalculation using the Charge Calculation Tool. Cause 6) Register the license to the all controllers.

	Symptom	Cause	Check procedure and remedy
6	The charge calculation results for some blocks are 0 yen.	1) Setting error of the refrigerant system 2) Setting error of the energy management block 3) Setting error of the cooling capacity/FAN consumption power in the indoor unit settings	Check causes 1) to 3). Correct the error and resolve the problem according to the causes shown in the analysis results. Causes 1) to 3) After correcting the settings and performing remedial apportionment, recalculate the change using the Charge Calculation Tool.
7	The display of charge calculation results for some AE-C is blank.	1) The date and time on AE-C are incorrect.	Check the cause and resolve the problem. Cause 1) Configure the time settings. Charges cannot be apportioned correctly if the date and time are incorrect. * When changing or adding AE-C, be sure to configure the time settings before use.
8	The same time period was calculated, but the results differ from the previous charge calculation results.	1) The unit price (\$/kWh etc.) was changed. 2) The energy management block was changed. 3) The apportioned data was edited. 4) The amount carried over became an effective apportioned value by performing remedial apportionment.	Check causes 1) to 4). * In the case of cause 4), any amount carried over to the next settlement period is carried over to the next day and onward. Take a measure suitable for the purpose of calculating the same time period and the billing status. → If the charge has already been settled and billed, sum up the difference on the next day of the settlement-of-accounts day using the Editing Apportioned Data function.
9	Misalignment of printed characters or garbled characters occur.	1) Printer driver is incompatible.	Cause 1) Check the printer driver on the OS. Also, check whether printing can be performed with other applications.
10	By inputting pseudo pulses into the electricity meter during the test run, charges including the pseudo pulses were billed by the tenant.	1) The input of pseudo pulses during the test run was not reported.	* We recommend that you perform a test run using signals such as pseudo pulse with the consent of the owner.
11	Billing results are wrong after making a time change in a period that spans two days.	1) The time was changed to one that spans two days.	* If the apportioned electricity billing function is used, keep the changes of time to a minimum. In particular, do not make time changes in a period that spans two days.
12	The Automatic Output setting of the Charge Calculation Tool is set to [Yes], but the automatic output is not being performed.	1) The following items were enabled on the PC settings (power option): • System standby • System in hibernation 2) Charge Calculation Tool was activated. 3) A LAN communication error occurred between the system and AE-C/EW-C.	Cause 1) Change the PC settings for "System standby," "System in hibernation," and "Turn off hard disk power" to [No] to enable continuous operation. Cause 2) Close the Charge Calculation Tool before the automatic output time. Cause 3) Check the LAN connection between PC and AE-C/EW-C and reconnect them. * Manually calculate the charges for the time periods for which automatic output was not performed.
13	The time period output by the automatic output of the Charge Calculation Tool is wrong.	1) The time on the PC is incorrect.	Cause 1) Correct the time on PC. * Manually calculate the charges for the time periods for which automatic output was not performed.

Symptom		Cause	Check procedure and remedy
14	When the Modbus interface of AE-C/EW-C is used, the billing apportionment results do not match the difference from the actual electricity meter.	1) The power of AE-C/EW-C was shut off due to a power failure. 2) AE-C/EW-C was being updated.	Check the cause and resolve the problem. Causes 1) and 2) Distribute the electric energy during the power failure/update to each connected unit using the Editing Apportioned Data function. This should be done, however, after obtaining consent from the owner.
15	The apportioned charge for a certain day is "0" due to a total power failure.	The power failure lasted all day.	No action is required since the charge is carried over to the next day.
16	Data is defined as Status-2 (with carry-over) even though electric energy is apportioned daily in the daily charge calculation results.	Normal	* With AE-C/EW-C, the electricity is apportioned every 30 minutes. This causes a carry-over to easily occur during the time period in which an air conditioning unit is stopped, such as nighttime. This is not a problem as the charge will be apportioned at the next apportionment time.
17	Electricity apportionment is not calculated correctly.	1) This symptom occurs when all of the conditions from (a) to (c) listed below are met. (a) AT-50A(B) and TC-24A(B) are used as a sub controller. (b) The time on AT-50A(B) and TC-24A(B) set based on the time of the host controller are behind by more than two minutes. (c) The time alarm settings on AT-50A(B) and TC-24A(B) are set to [Use].	Cause 1) Change the time alarm settings on AT-50A(B) and TC-24A(B) to [Do not use].

(2) Assumed cases and restoration method

The air conditioning charge obtained by the apportioned electricity billing function is calculated based on the operation amount data of the indoor unit. If data cannot be collected for some reason, irregular processing is performed. Corrections of apportioned data or remedial apportionment may be required, depending on the contents of this irregular processing. The table below shows assumed cases.

Table: Assumed cases and recovery method (for electric energy metering-device (meter connected) method)

Assumed case	Charge calculation result	Billing data status	Data restoration required or not required/method
PC failure (HDD failure)	(Non-displayable)	Charge calculation result data is destroyed.	Data restoration is not required.* 1
Communication error between AE-C/EW-C	Carry-over	Data is carried over and apportioned at the recovery time. (Data for several hours is collectively apportioned.)	Data restoration is not required.* 2
AE-C/EW-C unit failure	(Non-displayable)	Data is not apportioned. (Period: Error day–Recovery day)	Restore apportioned data (AE-C/EW-C)*2
AE-C/EW-C failure	Carry-over	Data is apportioned, but is incorrect. (Period: Error day–Recovery day)	Restore apportioned data (AE-C/EW-C) + Edit apportioned data
Meter failure	Normal	Data is not apportioned. (Period: Error day–Recovery day)	Edit apportioned data
PI controller failure	Carry-over	Data is not apportioned. (Period: Error day–Recovery day)	Clear comparison data + Edit apportioned data
Carried-over unused unit price	Carry-over	Unused unit price remains carried over. (Period: When settings are changed–Recovery day)	Clear comparison data
Setting error	Black characters (normal)	Data is apportioned based on the set information.	Remedial apportionment

\*1 We recommend that you back up the charge calculation results periodically against a failure.

\*2 If a carry-over for a long period of time that extends over the multiple settlement-of-accounts days occurs, we recommend that you correct the data on the Editing Apportioned Data screen. However, it is unnecessary to perform this procedure when there is an agreement with the tenant that allows the charge to be collected as the next day's portion, even if carry-over settlement occurs.

Table: Assumed cases and recovery method (for electric energy manual entry (meter not connected) method)

Assumed case	Charge calculation result	Billing data status	Data restoration required or not required/method
PC failure (HDD failure)	(Non-displayable)	Charge calculation result data is destroyed.	Data restoration is not required.* 1
Communication error between AE-C/EW-C	Carry-over	Data is carried over and apportioned at the recovery time. (Data for several hours is collectively apportioned.)	Data restoration is not required.* 2
AE-C/EW-C unit failure	(Non-displayable)	Data is not apportioned. (Period: Error day–Recovery day)	Restore apportioned data (AE-C/EW-C)*2
AE-C/EW-C failure	Carry-over	Data is apportioned, but is incorrect. (Period: Error day–Recovery day)	Restore apportioned data (AE-C/EW-C) + Edit apportioned data
Carried-over unused unit price	Carry-over	Unused unit price remains carried over. (Period: When settings are changed–Recovery day)	Clear comparison data
Setting error	Normal	Data is apportioned based on the set information.	Remedial apportionment

\*1 We recommend that you back up the charge calculation results periodically against a failure.

\*2 If a carry-over for a long period of time that extends over the multiple settlement-of-accounts days occurs, we recommend that you correct the data on the Editing Apportioned Data screen. However, it is unnecessary to perform this procedure when there is an agreement with the tenant that allows the charge to be collected as the next day's portion, even if carry-over settlement occurs.

**NOTE:**

- If there are two or more assumed cases, make overall judgment.
- When carry-over of apportionment spans the settlement-of-accounts day, the carried-over portion is added to the next month. If you want to separate this month's portion and the next month's portion, divide the apportionment parameter of carried-over and collected charge on the Editing Apportioned Data screen by the number of days in this month and the next month.

The following describes the outline of the restoration method.

	Overview	Application
Clear comparison data	Reset the carried-over data of the unused unit price.	Use this method when a unit price in use is changed to unused.
Edit apportioned data	Change the apportioned electric energy/ apportionment parameter data you want to correct by indoor units for each day. After all changes are completed, recalculate the air conditioning charge using the Charge Calculation Tool.	Use this method to correct or change the calculated apportionment parameter or apportioned electric energy.
Remedial apportionment	The apportioned electric energy for the remedial period is calculated by recalculating the apportionment from operation amount, electric energy, and other factors of the controller. Then, the air conditioning charge is calculated together with the charge for the normal period.	Use this method for reapportionment for the carry-over period.

(3) Restoration procedure

1) Logging in the Maintenance screen

Log in to the Maintenance screen on the Web browser to display the Maintenance screen.

URL: [http://\[IP address of AE-C/EW-C\]/control/index.html](http://[IP address of AE-C/EW-C]/control/index.html)

User name: maintenance

Password: Mainte + DP

For DP, refer to the back cover of the AE-C/EW-C Instruction Book (supplied with the controller).  
ex.) When DP is 123456, the password will be Mainte123456.

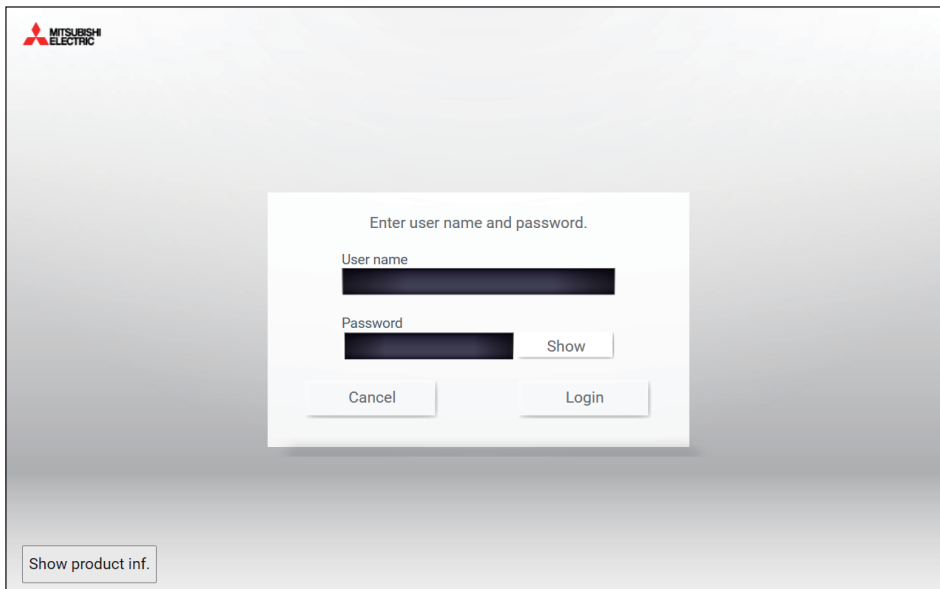

2) Clearing billing comparison data

Billing comparison data are used to obtain the increment through comparison between the latest value held by the AE-C/EW-C and the PI controller and the value obtained from the last apportioned calculation held by the AE-C/EW-C designated as the system manager.

When the AE-C/EW-C or the PI controller is replaced, the billing comparison data need to be cleared.

- 1. On the Maintenance screen on the Web browser, click **[Clearing Billing Comparison Data]**.

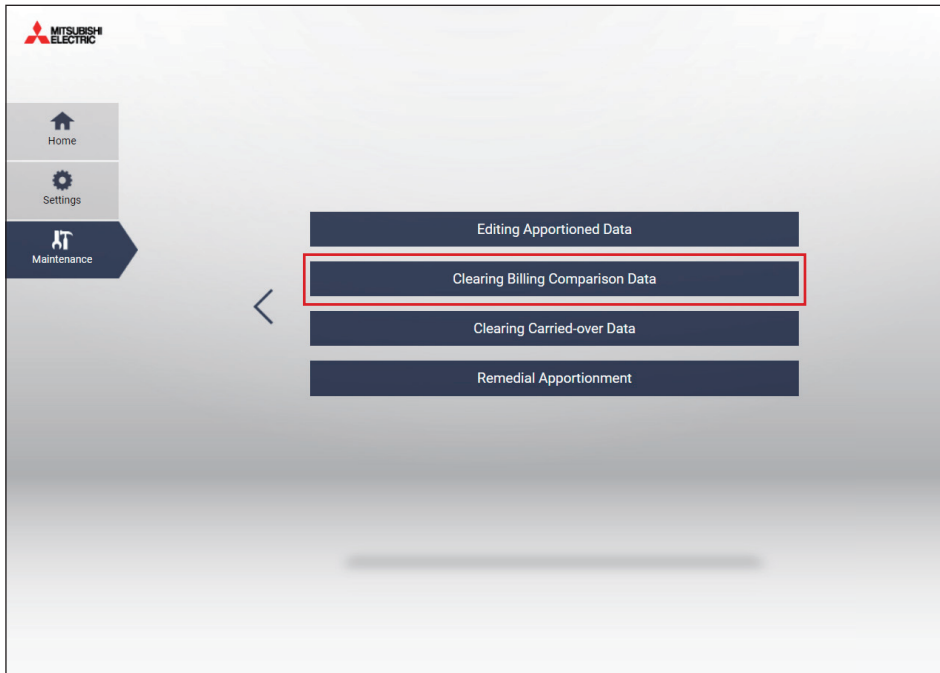

- 2. On the Clearing Billing Comparison Data screen, select **[Type]** and **[Target]**.

Click **[Type]**. To clear the billing comparison data of the AE-C/EW-C, select the target AE-C/EW-C under **[Operation amount]** on the Target Selection screen.

To clear the billing comparison data of the PI controller, select the target PI controller under **[Metering device]**.

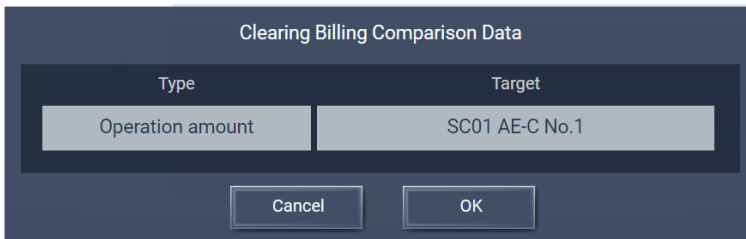

- 3. Click **[OK]**, and the billing comparison data will be cleared.

3) Editing apportioned data

If AE-C/EW-C fails, the operation time of an air conditioning unit or measurement value of the meter cannot be measured until AE-C/EW-C is replaced. Therefore, apportionment calculation cannot be performed for the period during which AE-C/EW-C is broken.

This chapter describes the method of correcting apportioned data for the period during which AE-C/EW-C is broken, after replacing AE-C/EW-C.

**NOTE:**

- If AE-C/EW-C fails, you can correct apportioned data automatically by using the Remedial Apportionment function. For the remedial apportionment method, refer to "4) Remedial apportionment."

**IMPORTANT:**

- Corrections can be made on data from 123 days ago to the previous day. Data earlier than 123 days ago cannot be corrected.
- Do not perform remedial apportionment for the period for which corrections of apportioned data have been made. Doing so will change the data back to one before the correction was made.
- The Editing Apportioned Data function is performed to correct the apportionment calculation results for each day used in the Charge Calculation Tool.
- Please note that the electric energy displayed on the Energy Use Status screen or Ranking screen, or the electric energy displayed in the energy management table cannot be corrected.

1. Click **[Editing Apportioned Data]** on the Maintenance screen of the Integrated Centralized Control Web.

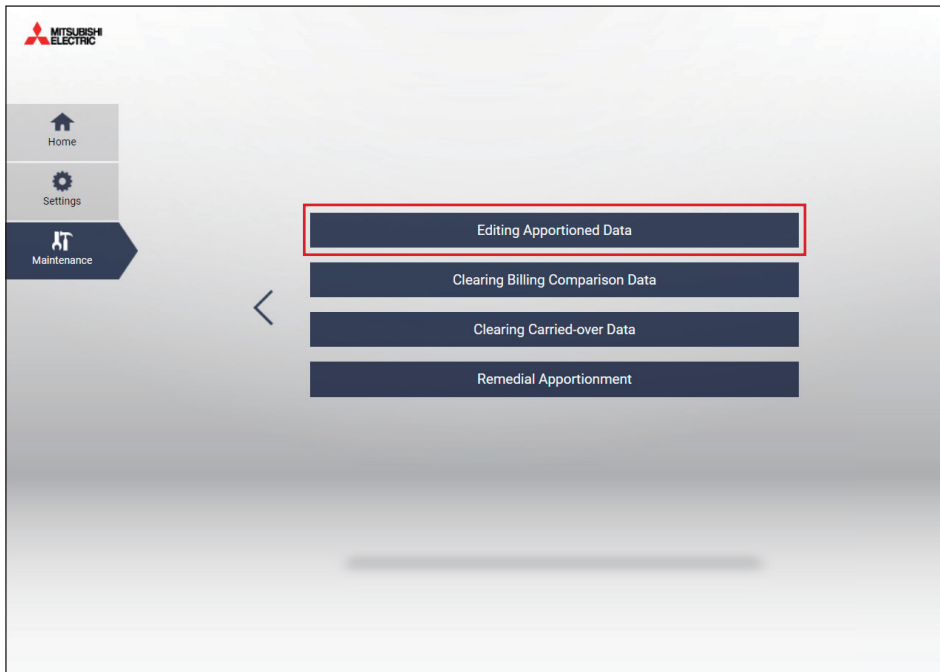

2. Click the AE-C/EW-C to which the replaced AE-C/EW-C belong, and then click **[Next]**.



3. Click the date you want to correct, and then click **[Next]**.  
Corrections can be made on data within the range from 123 days ago to the previous day.

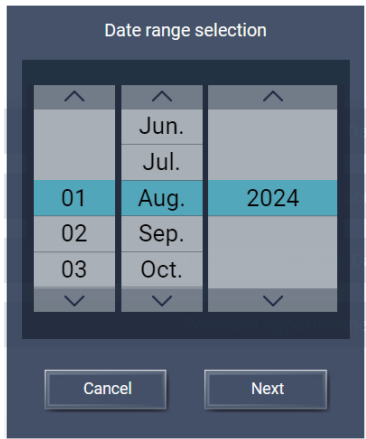

4. Click **[Energy mgmt block]**, and then click **[Next]**.



5. Click the energy management block you want to correct. Then, from the address list, click the **[Edit data]** button of the unit to be corrected.

Editing Apportioned Data

Target date	Target SC	Target object	Energy mgmt block
01/08/2024	SC01 AE-C No.1		

Energy mgmt block

Tenant1

Address01-030	Edit data
Address01-031	Edit data
Address01-032	Edit data
Address01-033	Edit data
Address01-034	Edit data
Address01-037	Edit data
Address01-038	Edit data
Address01-039	Edit data

1 / 1

Cancel OK

6. Correct the apportioned electric energy by unit price.

Correction examples are shown below.

Example 1: Correction using the average value of one week before failure

→ Calculate the average value of the apportioned electric energy for one week before failure, multiply the value by the number of days of the failure period, and input it as the apportioned electric energy for the day prior to the recovery day.

If a failure occurred on a day that overlaps the monthly settlement-of-accounts day, input the apportioned electric energy for the number of days before and after the settlement day within the failure period, on the day prior to the settlement day and the day prior to the recovery day, respectively.

Example 2: Correction using the normal period only

→ With this method, the electric energy is not billed during the failure period. Input "0" for the apportioned electric energy for the number of days of the failure period.

**Editing Apportioned Data**

Target date	01/08/2024	Target SC	SC01 AE-C No.1	Target object	Energy mgmt block
Energy mgmt block			Unit		
Tenant1			Address01-030		
Item	Unit price1	Unit price2	Unit price3	Unit price4	Unit price5
Indoor unit electric energy consumption [kWh]	0.0	0.0	0.0	0.0	0.0
Indoor unit standby electric energy [kWh]	0.0	0.0	0.0	0.0	0.0
Outdoor unit electric energy consumption [kWh]	5.0	6.0	-	-	-
Outdoor unit standby electric energy [kWh]	0.2	0.3	-	-	-
Capacity save amount	49	75	-	-	-
FAN operation time	182	166	-	-	-
Thermo-ON time	97	106	-	-	-
Total electric energy for this block		01/08/2024			
Before editing	-	-	-	-	-
After editing	-	-	-	-	-

Estimation

Cancel
OK

**NOTE:**

- Correctable items vary according to the apportionment mode settings on the Initial Setting Tool.

7. Select the **[OK]** button.

8. Perform Steps 6 and 7 for every unit that needs to be corrected.

9. On the Editing Apportioned Data screen, click the **[OK]** button to complete the correction settings.

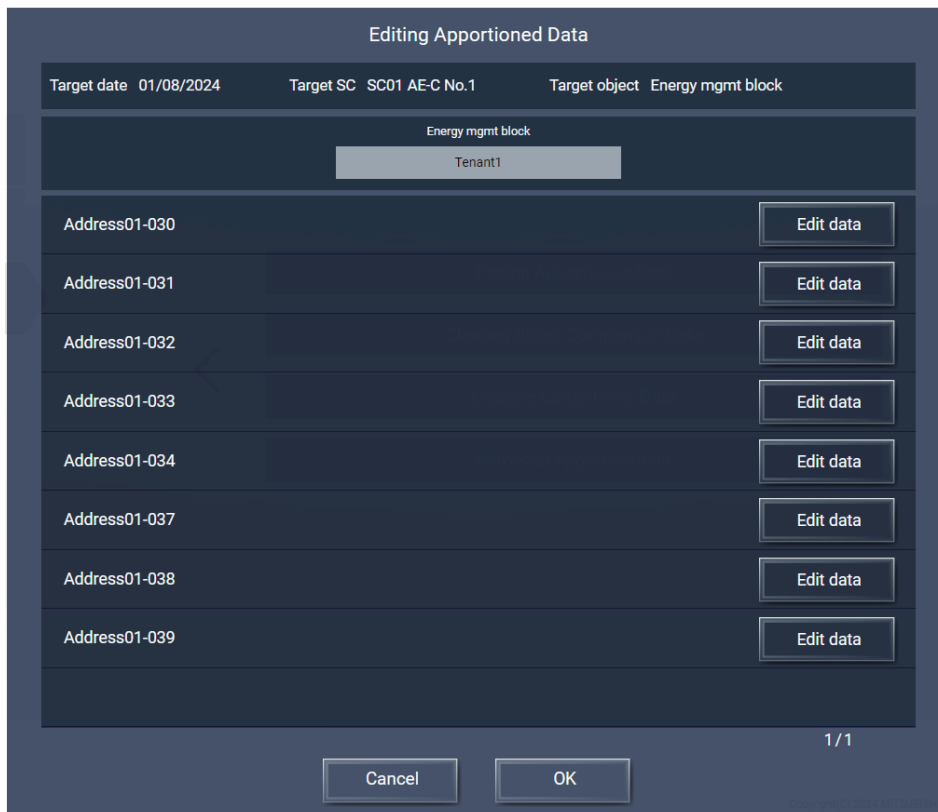

**NOTE:**

- If you close the browser without clicking the **[OK]** button on the Editing Apportioned Data screen, the correction result will not be saved.

10. Calculate the charge using the Charge Calculation Tool, and check that the correction results are reflected.

4) Remedial apportionment

Apportionment calculation is not performed during the failure period of AE-C/EW-C.

This chapter describes the method of recalculating apportionment (performing remedial apportionment) for the failure period after replacing AE-C/EW-C.

**NOTE:**

- Remedial apportionment is not performed when AE-C/EW-C has failed. To make a correction, use the Editing Apportioned Data function.  
For the method of correcting apportioned data, refer to “3) Editing apportioned data.”
- This procedure can be used to recalculate daily apportionment for the period of a communication error even when a long-term communication error between AE-C/EW-C has occurred. In this case, start the procedure from Step 2 after recovering from the communication error.

**IMPORTANT:**

- Remedial apportionment can be performed on data from 61 days ago to the previous day. Data for the current date and the date earlier than 61 days ago cannot be remedied.
- Do not perform remedial apportionment for the period for which corrections of apportioned data have been made. Doing so will change the data back to one before the correction was made.
- The Remedial Apportionment function is performed to correct the apportionment calculation results for each day used in the Charge Calculation Tool.  
Please note that the electric energy displayed on the Energy Use Status screen or Ranking screen, or the electric energy displayed in the energy management table cannot be corrected.
- While regular apportionment is performed by using data for 30 minutes, remedial apportionment is performed using data for one day. Therefore, the calculation results differ between the regular apportionment and remedial apportionment. (30-minute data cannot be retained for a long period of time. Instead, apportionment is performed using data for one day.)  
Perform remedial apportionment only for the period when data has errors.

1. Click **[Remedial Apportionment]** on the Maintenance screen of the Integrated Centralized Control Web.

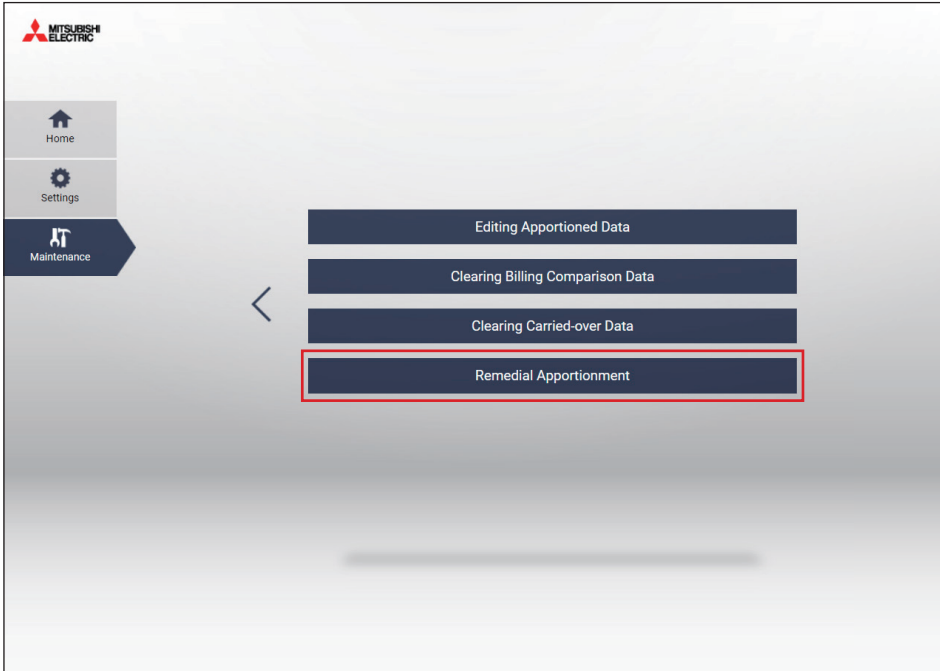

2. To start remedial apportionment, set the period of remedial apportionment, and then click **[OK]**. Set the period from the day prior to the day AE-C/EW-C failed to the previous day.

**NOTE:**

- Remedial apportionment can be performed on data from 122 days ago to the previous day.
  - Remedial apportionment may take several to dozens of minutes.
3. Calculate the charge using the Charge Calculation Tool, and check that the remedial apportionment results are reflected.

(4) Data collection method for troubleshooting of apportioned electricity billing function

Data collection may be required to investigate problems that occur with the apportioned electricity billing function.

■ Data required for investigation

- 1) AE-C/EW-C Setting data
- 2) Billing parameter, Metering Device Data
- 3) Billing apportionment results data
- 4) AE-C/EW-C Setting data of Initial Setting Tool
- 5) Serial numbers of all AE-C/EW-C in the system

■ Data collection method

- 1) AE-C/EW-C Setting data
  - i ) Insert the USB memory device into AE-C/EW-C.
  - ii ) Tap [Maintenance] on the AE-C's LCD screen or the initial setting screen on the Web browser.
  - iii ) Tap [Back up/import settings data], and then tap [Back up settings data].

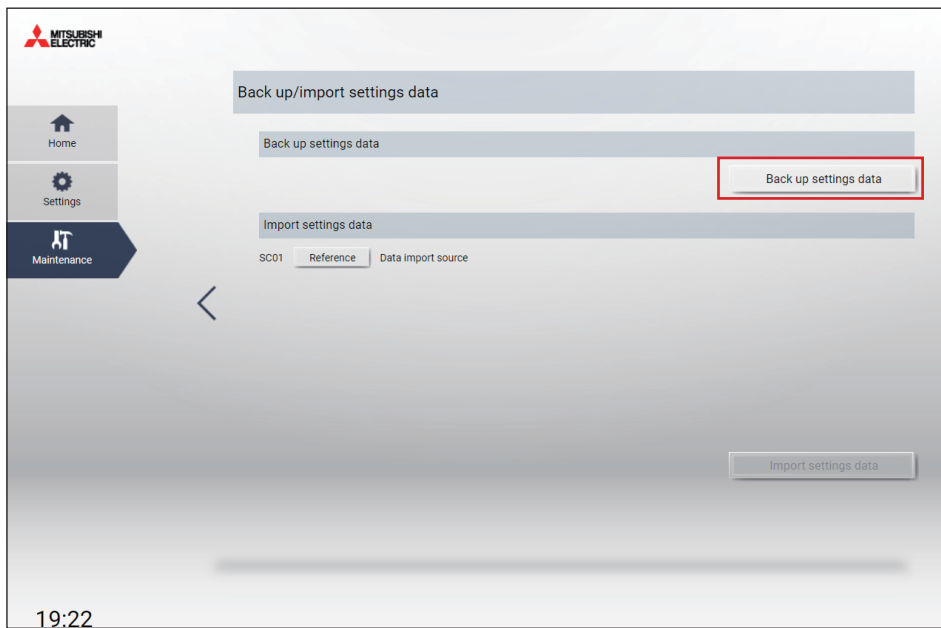

2) Billing parameter

- i ) Insert the USB memory device into AE-C.
- ii ) Go to [Maintenance]→[CSV output] on the Initial Settings screen of AE-C LCD, and select [Charge Parameters], [Metering device data], [Charge Parameters (30-minute intervals)], and [Metering device data (30-minute intervals)]. Then, press [CSV output] to output data to the USB memory device.

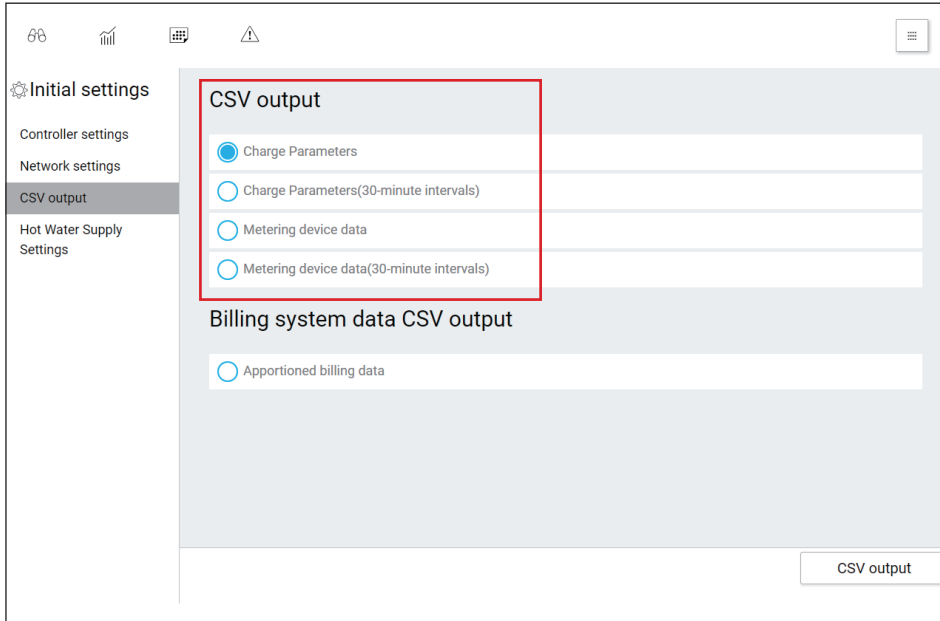

3) Billing apportionment results data

- i ) Insert the USB memory device into AE-C.
- ii ) Go to [Maintenance]→[CSV output] on the Initial Settings screen of AE-C LCD, and select [Apportioned billing data]. Then, press [CSV output] to output data to the USB memory device.

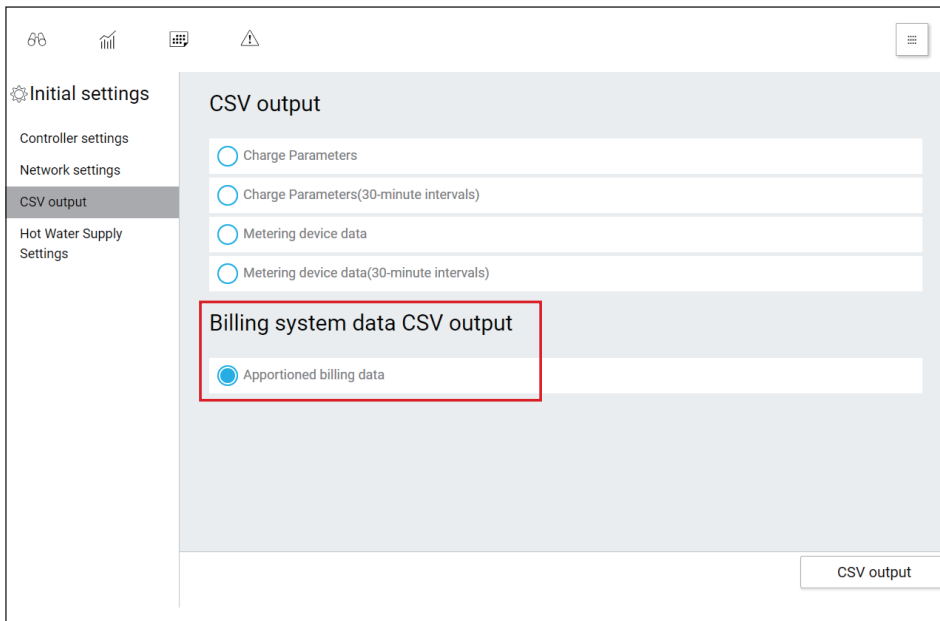

- iii ) Select [EM block], and then select [Data in 30-minute increments]. Then, press [Output] to output data to the USB memory device. Data for one month and one day can also be output to the USB memory device by selecting [Daily data] and [Monthly data]. (Period setting is not required.)

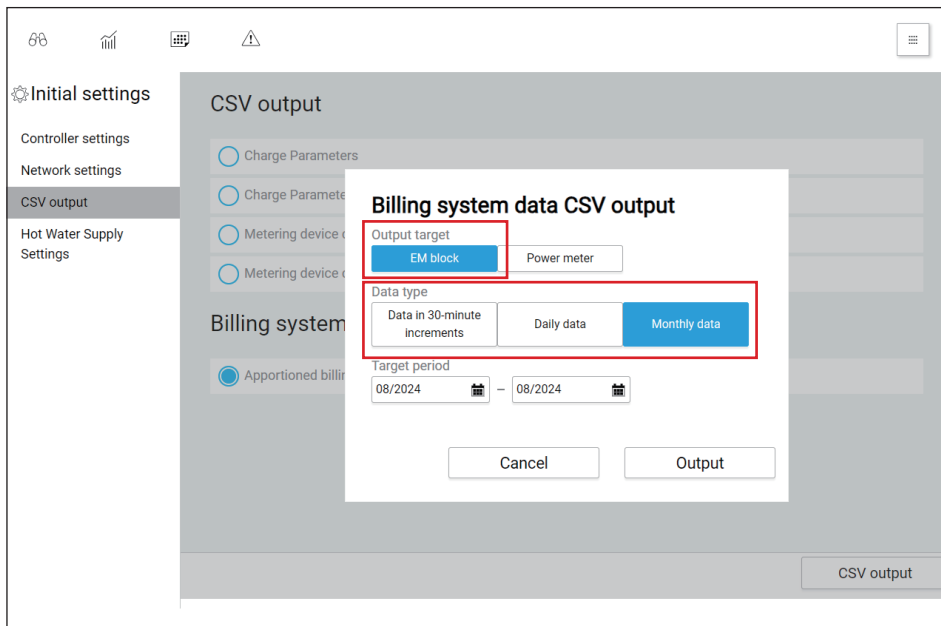

**[10] Troubleshooting (BACnet function)**

The following shows troubleshooting for the BACnet function.

(1) Troubleshooting based on trouble examples

Category	Symptom	Cause	Check method and remedy
1	Building management system (communication) AE-C/EW-C does not respond to the building management system. AE-C/EW-C cannot be found from the building management system.	LAN2 (BACnet) is disconnected or a wire is broken.	<ul style="list-style-type: none"> <li>Check that there is no abnormality with any of the connector connections on the path from the LAN2 (BACnet) to the building management system.</li> <li>If there is a LINK/ACT lamp on the hub connecting the LAN2 (BACnet), check that it is lit.</li> <li>Replace the LAN cables with ones that are working properly.</li> </ul>
		The IP address of the LAN2 (BACnet) of AE-C/EW-C or building management system is incorrect.	<p>Check the following, and change the setting if there is a problem.</p> <ul style="list-style-type: none"> <li>Send pings to the IP addresses of the building management system and LAN2 (BACnet) of AE-C/EW-C from Command Prompt on a PC for performing checks, and confirm that packets arrive.</li> <li>Execute "Acquire settings" from BACnet Setting Tool and then check the BACnet setting information.</li> </ul>
		The IP address of the LAN2 (BACnet) of AE-C/EW-C duplicates that of other equipment.	<ul style="list-style-type: none"> <li>Send a ping from Command Prompt on a PC for performing checks while the LAN2 (BACnet) of AE-C/EW-C is disconnected, and confirm that there is no response. If there is a response, change the IP address of the equipment with the duplicate IP address or the IP address of the AE-C/EW-C.</li> <li>Execute "Acquire settings" from BACnet Setting Tool, and then check whether the network addresses of LAN 1 and LAN 2 (BACnet) of AE-C/EW-C are the same. If they are the same, change the network address of LAN 1 or LAN 2 (BACnet).</li> </ul>
		The AE-C/EW-C BACnet connection mode is not "Online".	<p>Check that "Current Mode" on the Mode Setting screen of BACnet Setting Tool is "Online". If it is not "Online", set it to "Online". (Note that the mode will be "Offline" after "Send settings" is executed from BACnet Setting Tool.)</p>
		<ul style="list-style-type: none"> <li>The request from the building management system was not sent.</li> <li>The response was not sent from the AE-C/EW-C.</li> </ul>	<p>Connect a network analyzer (e.g., Wireshark), capture packets, and confirm that the expected request and response are made over BACnet. If the request is not made, recheck the settings of the building management system. If the response is not made, recheck the settings of the AE-C/EW-C.</p> <p>For the packet capture procedure, refer to "IV [1] How to Use Wireshark for AE-C/EW-C BACnet".</p>
		The object or property that the building management system requests does not exist.	<ul style="list-style-type: none"> <li>Execute "Acquire settings" from BACnet Setting Tool and then check that the object the building management system requests is included in the BACnet setting information. If the object the building management system requests is not included, recheck the settings of the AE-C/EW-C.</li> </ul>

Category	Symptom	Cause	Check method and remedy
7	The response from the AE-C/EW-C is slow or some of the response is missing.	There is a possibility that the request interval from the building management system via BACnet communication exceeds the response performance of the AE-C/EW-C.	Set a request frequency of 5 properties or less per second by checking with the system integrator of BACnet about either increasing the interval for state collection or reducing the number of properties target for collection on the building management system side.
8		The communication speed of LAN2 (BACnet) has decreased.	<ul style="list-style-type: none"> <li>• Check whether or not network equipment (LAN cable, hub, router, etc.) with a communication speed of less than 100 Mbps is connected to the LAN2 (BACnet), and if such equipment is connected, replace it with high-speed equipment or disconnect it.</li> <li>• Check whether or not equipment that performs communication other than BACnet is connected to the LAN2 (BACnet), and if such equipment is connected, disconnect it.</li> </ul>
9	The response from the AE-C/EW-C is slow or communication becomes unstable. The COL lamp of the hub connecting the AE-C/EW-C lights very frequently.	There is a possibility of the state of inconsistencies occurring in Ethernet Auto Negotiation.	Check whether or not any equipment that communicates with the AE-C/EW-C has Auto Negotiation disabled. If it is disabled, enable it. (The AE-C/EW-C supports Auto Negotiation.)
10	Even though COV notification is used, it takes time to be reflected in the building management system.	The COV notification process ID is not set to an appropriate value.	Set the COV notification process ID to an appropriate value (usually 0, but check with the administrator because it is dependent on the building management system).
11	The state indication on the building management system does not change. (Operation from the building management system is possible.) The AE-C/EW-C has detected error code 6600.	The M-NET address is duplicated with that of another system controller connected to the same M-NET as the AE-C/EW-C.	Change the M-NET address of the AE-C/EW-C so that it is not duplicated and then restart the AE-C/EW-C.
12	BACnet communication became no longer possible when a new air conditioning unit or PI controller was registered on the AE-C/EW-C.	When the equipment configuration is changed, the BACnet connection mode may become "Offline".	If there is also a change to the BACnet settings, set the settings again with BACnet Setting Tool. Then, change BACnet connection mode to "Online" from the Mode Setting screen of BACnet Setting Tool.

	Category	Symptom	Cause	Check method and remedy
13	Building management system (error display)	When an air conditioning unit is set to run, an alarm is displayed by the building management system.	The building management system may determine there to be an alarm and display the alarm because the "InAlarm" bit of the "Status_Flags" property is ON, or the "Event_State" property is "Offnormal", or the "Notify Type" parameter of event notification is "Alarm".	When the event notification of "On Off State" (BI_01xx02) is used, set "NotifyType" of event notification of "On Off State" (BI_01xx02) not to "Alarm" but to "Event" from BACnet Setting Tool. Disable (clear the check box for using) event notification of "On Off State" (BI_01xx02). If the process of determining this to be an alarm on the building management system side can be canceled, have it canceled.
14		When the on/off operation is performed from the AE-C/EW-C or a remote controller, an error is detected on the building management system side. When the on/off operation is performed from the building management system, an error is not detected.	A mismatch of the "On Off Setup" object (BO_01xx01) and "On Off State" object (BI_01xx02) is occurring.	This is not a malfunction. Configure the settings so that an error due to a mismatch of both object states is not detected on the building management system side.

Category	Symptom	Cause	Check method and remedy
15	BACnet Setting Tool The settings cannot be configured from BACnet Setting Tool. (The "Response Timeout" message appears.)	<ul style="list-style-type: none"> <li>LAN1 of the AE-C/EW-C is not set correctly.</li> <li>The PC for setting is not set correctly.</li> </ul>	Configure the settings so that Web Browser for Initial Settings or Initial Setting Tool can connect referring to the AE-C/EW-C Instruction Book (Detailed operations) or BACS-AP50 Instruction Book (Detailed operations).
		The network addresses of LAN1 of the AE-C/EW-C and the PC for setting do not match.	Set the correct IP address and subnet mask referring to the AE-C/EW-C Instruction Book (Detailed operations) or BACS-AP50 Instruction Book (Detailed operations).
		The AE-C/EW-C is restarting.	If the AE-C/EW-C is restarting, wait a while (maximum of about 10 minutes) and then connect.
		The IP address (LAN1) of the AE-C/EW-C unit and the setting destination IP address (LAN1) of BACnet Setting Tool do not match.	Set IP address of both so that they match. The setting destination IP address of BACnet Setting Tool can be checked from [AE-C/EW-C] - [Property] on the menu bar. (For BACS-AP50, [BACS-AP50] - [Property]) If the IP address (LAN1) of the AE-C/EW-C unit is unknown, refer to "When forgetting the IP address of LAN1" below.
19	Even if the BACnet connection mode is set to "Online" on the Mode Setting screen of BACnet Setting Tool, the mode does not change to "Online".	The "BACnet connection" license has not been registered.	Register the "BACnet connection" license referring to the AE-C/EW-C Instruction Book (Detailed operations). * Not applicable for BACS-AP50
		"Send settings" has not been executed even once with BACnet Setting Tool or the settings sent with "Send settings" included inconsistencies.	Do not change the settings on the AE-C/EW-C LCD, etc. during the period from executing "Acquire settings" with BACnet Setting Tool to executing "Send settings" after configuring the BACnet information settings. If a setting was changed during the process, execute "Acquire settings" again.
		A metering device has been registered in "Measurement" but the accumulator (PI controller Electric Energy 1-4 or Pulse Input Electric Energy 1-4) supporting the metering device has not been enabled.	When a metering device will be used, select the check box even if the corresponding object will not be used. * Not applicable for BACS-AP50
		The notification destinations of the "Recipient_List" properties of the Notification Class object exceeds 5 devices.	For the notification destinations of the "Recipient_List" properties, the notification destination addresses registered with BACnet Setting Tool and those registered from the building management system are managed separately, so make sure the total of both does not exceed 5 devices.
23	IP address When forgetting the IP address of LAN1.	-	Check it on the LCD of the AE-C. If you have forgotten the LAN1 IP address of EW-C, set it again with SW1 on the unit referring to the AE-C/EW-C Instruction Book (Detailed operations).
		When forgetting the IP address of LAN2 (BACnet).	-
24			

**[11] Troubleshooting for chiller unit connection function**

Symptom		Cause	Check procedure and remedy
1	The monitoring screen of chiller unit does not appear.	1) Chiller unit is not registered to the group. 2) Chiller unit is in a state of communication error.	Cause 1) Register the chiller unit to the group from the Initial Settings screen. Cause 2) Check the error code and remove the cause of the communication error. For the error codes, refer to "III [4] 1. How to determine the cause and resolve trouble based on the detected error display of the AE-C/EW-C."
2	The operation mode was changed, but the unit returns to the mode before the change after a while.	1) The operation mode was changed without setting the unit to a stopped state. 2) The Main Unit setting of the chiller unit (Command Input Source setting) is set to a unit other than "System Controller."	Cause 1) When changing operation modes, first [Stop] the unit, and then change the operation mode to [Cool]/[Heat]. Next, after at least one minute has passed, make sure that the operation mode has been changed on the monitoring screen, and then perform the operation by clicking [Operation]. Cause 2) Set the Main Unit of the chiller unit (Command Input Source setting) to "System Controller." For the setting method, refer to the technical materials for the unit.
3	The operation, set water temperature, or fan mode was changed, but the unit returns to the mode before the change after a while.	The Main Unit setting of the chiller unit (Command Input Source setting) is set to a unit other than "System Controller."	Set the Main Unit of the chiller unit (Command Input Source setting) to "System Controller." For the setting method, refer to the technical materials for the unit.
4	The units are not aligned by system for display on the monitoring screen.	On the Initial Settings screen, the smallest group number is not assigned as the group number of the system representative group.	When performing group registration, assign the smallest group number in the system to the system representative group.

**[12] Troubleshooting for HWHP (QAHV)**

Symptom		Cause	Check procedure and remedy
1	The monitoring screen of the HWHP unit does not appear.	1) The HWHP unit is not registered.	Cause 1) Register the HWHP unit from the Initial Settings screen.
2	It takes a long time for the amount of hot water in tank to reach the target value, or it does not reach the target value.	1) The effective temperature of hot water in tank is higher than the boiling temperature set in the schedule. 2) An error was detected on the unit.	Cause 1) An error occurs when the effective temperature of hot water in tank is set on the Initial Settings screen after configuring the schedule settings. Set the effective temperature of hot water in tank lower than the boiling temperature in the schedule. Cause 2) Check the error code. For details on the error codes, refer to the technical materials for the unit.
3	It takes a long time for the water temperature to reach the set temperature, or it does not reach the set temperature.	1) The boiling temperature is lower than the temperature set in the schedule. 2) An error was detected on the unit.	Cause 1) An error occurs when the boiling temperature is set on the Initial Settings screen after configuring the schedule settings. Set the boiling temperature higher than the set temperature in the schedule. Cause 2) Check the error code. For details on the error codes, refer to the technical materials for the unit.
4	The schedule settings on the HWHP unit do not operate.	1) Incorrect schedule settings are configured. 2) The time on AE-C/EW-C or the time on the unit is different from the current time. 3) A schedule is duplicated with the settings for a schedule with higher priority such as the yearly schedule.	Cause 1) The schedule settings are retained for each system. Check whether the schedule settings for the system you want to operate are correct. Cause 2) Check the time settings on AE-C/EW-C or the unit. Cause 3) The order of priority for schedules from higher to lower is yearly schedule and weekly schedule.

	Symptom	Cause	Check procedure and remedy
5	The schedule settings on the HWHP unit do not operate.	1) Incorrect schedule settings are configured. 2) The period settings for schedules are incorrect. 3) The [OK] button was pressed while the display area in today's schedule was still blank. 4) The time on AE-C/EW-C or the time on the unit is different from the current time. 5) The "Schedule" on the operation screen is set to [Disabled]. 6) A schedule is duplicated with the settings for a schedule with higher priority such as the yearly schedule. 7) The "Schedule/Season setting" in the advanced settings is set to [Disabled]. 8) On the weekly schedule settings screen, the period settings are set to [Disabled].	Check causes 1) to 3). Take the measure corresponding to the cause. For causes 1) and 2), check causes 1) and 2) described for symptom 6. Cause 3) The order of priority for schedules from highest to lowest is today's schedule, yearly schedule, weekly schedule 1, ... weekly schedule 5. Cause 4) One of the weekly schedules operates according to the set period. Check the period settings on the season settings screen to see if there is any error. Cause 5) If the [OK] button is pressed while the display on today's schedule settings screen is left blank, the schedule is handled as having been set not to operate. Set the schedule to be operated again from today's schedule settings screen. Cause 6) Change the setting to [Enabled]. Cause 7) Set the "Schedule/Season setting" in the advanced settings to [Enabled]. For details, refer to the AE-C/EW-C Instruction Book (Detailed operations). Cause 8) The season settings for the weekly schedule are the same as those for air conditioning unit and other units. Enable the season settings that have been set to [Disabled]. Ensure that the schedule settings for weekly schedule 5 cover the entire period and are set to [Enabled]. For details, refer to the AE-C/EW-C Instruction Book (Detailed operations).

	Symptom	Cause	Check procedure and remedy
6	A message saying, "System is not connected to the HWHP unit properly, or advanced settings are not complete. Check the settings or connection with the HWHP unit and complete the detail settings." appears.	1) A device other than HWHP unit is connected to the address set on the HW Supply screen of AE-C/EW-C. 2) The description of HW Supply of AE-C/EW-C and the configuration and settings for the HWHP unit do not match. 3) The board digital settings for the HWHP unit are incorrect. 4) The advanced settings for HW Supply are not complete.	Check causes 1) to 4). Take the measure corresponding to the cause. Cause 1) Check the connected device and reconfigure the settings on the HW Supply screen. Cause 2) Check the address registration of HW Supply and the device configuration of the HWHP unit. If the address registration and the device configuration are different, review the address registration. Cause 3) After setting the set value to 2 for item code 107 in the board digital settings on the HWHP unit, perform one of the following operations with AE-C/EW-C. (a) With AE-C/EW-C, delete the address settings and save the settings, and then reset the address. (b) Restart AE-C/EW-C. For details on digital settings for the unit, refer to QAHV Installation Manual. If the problem persists after implementing the check methods and solutions for causes 1) to 3), check cause 4) and resolve the problem. Cause 4) Open the advanced settings screen of the HWHP unit system displayed in [HWHP unit system name] and complete the settings. Press the [OK] button, and then [Save Settings] on the settings screen of the HWHP unit. For details on the settings for AE-C/EW-C, refer to the AE-C/EW-C Instruction Book (Detailed operations).
7	Trend data related to time and integration are not output with the correct values.	1) This symptom occurs when all of the conditions from (a) to (c) listed below are met. (a) AT-50A(B) and TC-24A(B) are used as a sub controller. (b) The time on AT-50A(B) and TC-24A(B) set based on the time of the host controller are behind by more than two minutes. (c) The time alarm settings on AT-50A(B) and TC-24A(B) are set to [Use].	Cause 1) Change the time alarm settings on AT-50A(B) and TC-24A(B) to [Do not use].
8	The execution of a schedule is delayed.	1) This symptom occurs when all of the conditions from (a) to (c) listed below are met. (a) AT-50A(B) and TC-24A(B) are used as a sub controller. (b) The time on AT-50A(B) and TC-24A(B) set based on the time of the host controller are behind. (c) The time alarm settings on AT-50A(B) and TC-24A(B) are set to [Use].	Cause 1) Change the time alarm settings on AT-50A(B) and TC-24A(B) to [Do not use].

[III. Troubleshooting ]

	Symptom	Cause	Check procedure and remedy
9	The yearly schedule is not executed.	1) This symptom occurs when all of the conditions from (a) to (c) listed below are met. (a) AT-50A(B) and TC-24A(B) are used as a sub controller. (b) The time on AT-50A(B) and TC-24A(B) set based on the time of the host controller are behind by more than one week. (c) The time alarm settings on AT-50A(B) and TC-24A(B) are set to [Use].	Cause 1) Change the time alarm settings on AT-50A(B) and TC-24A(B) to [Do not use].

### [13] R32 refrigerant leak buzzer failure

For BACS-AP50, the R32 refrigerant leak buzzer function is not available.

	Symptom	Cause	Check procedure and remedy
1	The buzzer on the controller does not sound during circuit inspection for refrigerant leak.	1) The refrigerant leak buzzer setting is disabled. 2) The controller is faulty.	Cause 1) On the Initial Setting Tool, select [Basic System Settings] - [System Configuration Settings] and enable [Refrigerant leak buzzer settings]. Cause 2) On the Controller settings screen, set [Sound volume] to "3 (max)," and operate the touch panel to see if the buzzer sounds or not. If the buzzer does not sound, the controller is faulty. Replace the controller.
2	The external alarm buzzer connected to CN6 does not sound during circuit inspection for refrigerant leak.	1) The external alarm buzzer is disconnected. 2) External output (CN6) setting is set to [Not in use]. 3) The alarm buzzer is faulty.	Cause 1) Check the connection between CN6 and the external alarm buzzer. Cause 2) On the Initial Setting Tool, select [Basic System Settings] - [System Configuration Settings] and set [External output (CN6) setting] to [Refrigerant leak error output]. Cause 3) Check the buzzer operation, referring to the instruction manual for the external alarm buzzer.

### [14] Controller replacement

After replacing the controller, follow the steps below to restore the settings.

- (1) Turn off the breaker, and disconnect the power cord from the controller before replacement.
- (2) Disconnect the M-NET cable and other cables from the controller. (Protect the disconnected cables from shorts.)
- (3) Replace the controller with a new one.
- (4) Re-connect the disconnected cables, turn on the breaker, and turn on the controller.
- (5) Set the IP address, referring to "4-1. Quick IP address (LAN1) setting" in the BACS-AP50 Instruction Book (Detailed operations).
- (6) Load the saved setting file to the controller.
  - To restore the setting data, refer to "10-3. Backing up/importing settings data" in the BACS-AP50 Instruction Book (Detailed operations).
  - To restore the setting data of the BACnet Setting Tool, refer to "7. Saving settings data" in the BACS-AP50 Instruction Book (Detailed operations).
- (7) Set the date and time, referring to "8-2-5. Date and Time" in the BACS-AP50 Instruction Book (Detailed operations).

## [15] microSD card replacement - Restore overview

Replacement or restoration of the microSD card requires a replacement microSD card. For information on how to obtain a replacement microSD card, contact the sales office.

### 1. microSD card write/read error

Error patterns, states of microSD cards, and affected data are as follows.

Error pattern	Error pattern details	Error location	Data affected by card error	Summary of card replacement and restoration
[A]	Any of the following occurs. (a-1) Error code [6204] appears on the Notice screen. (a-2) The LEDs on the front blink while the startup screen (initializing) is displayed. (a-3) The STATUS LED blinks in orange.	microSD card 1	None	i ) Remove and discard microSD card 1. ii ) Insert microSD card 2 into the card 1 slot (CN13). iii ) Insert a replacement card (service part) into the card 2 slot (CN14). iv ) Restore data.
[B]	Any of the following occurs. (b-1) Error code [6206] appears on the Notice screen. (b-2) The STATUS LED blinks in yellow.	microSD card 2	Graphs and CSV output data for the following functions are lost. • Energy management (including data of hot water supply) • Peak cut	i ) Remove and discard microSD card 2. ii ) Insert a replacement card (service part) into the card 2 slot (CN14). iii ) Restore data.

**NOTE:**

- Back up the configuration data before replacing the microSD card.  
For the method of backup or restoration, refer to the AE-C/EW-C Instruction Book (Detailed operations) or BACS-AP50 Instruction Book (Detailed operations).

### 2. microSD card replacement procedure

(1) Procedure for microSD card replacement on AE-C

When replacing the microSD cards due to malfunction or other reasons, follow the procedure below.

Note that two microSD cards (microSD card 1 and microSD card 2) are installed in the AE-C. The replacement procedure differs depending on the error location (shown in item 1 above).

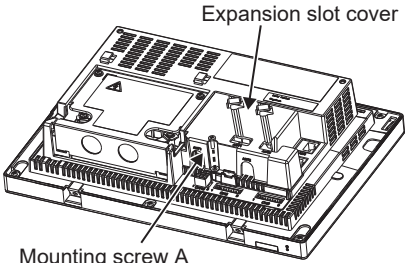
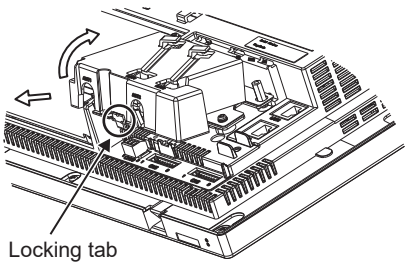
Step		
1	Shut off the power to the AE-C, and check that ① on the bottom is off.	
2	Disconnect all the cables (AC power cable, M-NET transmission cable, CN5, CN6, CN10). Remove the controller from the control box or bracket, and place it with the LCD facing down.	
3	Remove the mounting screw A (one screw) from the expansion slot cover.	
4	Lift and remove the expansion slot cover while pushing the locking tab. • If the communication antenna is protruding from inside the cover, be careful not to apply any force or impact to the antenna. • If no communication antenna is installed, go to step 7.	

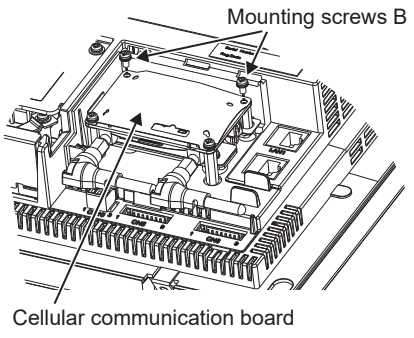
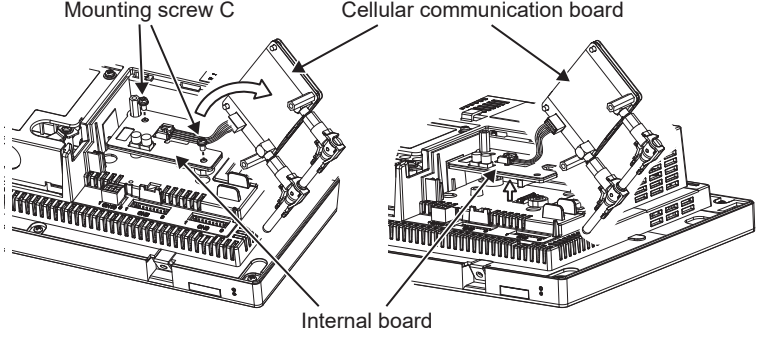
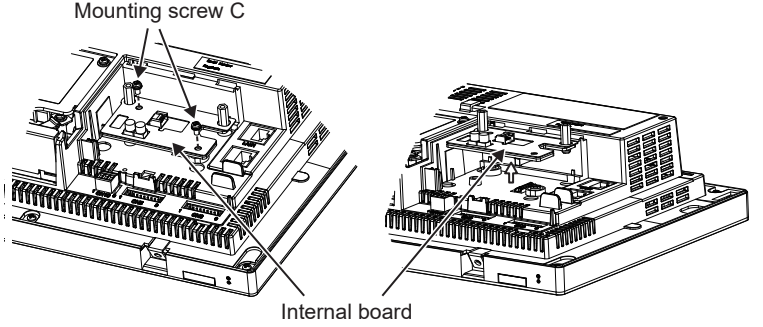
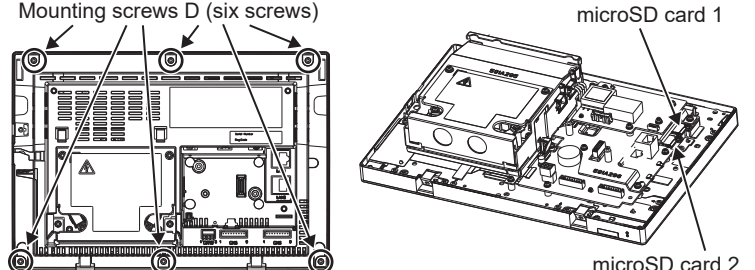
Step	
<p>5 Remove the mounting screws B (two screws) from the board (cellular communication board) to which the communication antenna is connected.</p>	
<p>6 (Perform the step below if a cellular communication board is mounted.) Turn the cellular communication board over as shown in the figure, remove the mounting screws C (two screws) from the internal board, and lift and remove the internal board. Go to step 8.</p>	
<p>7 Remove the mounting screws C (two screws) from the internal board, and lift and remove the internal board.</p>	
<p>8 Remove the mounting screws D (six screws) from the rear panel, and remove the black cover. The SD card slots on the side of the controller will be visible.</p>	

Step	
9	<p>■ For error pattern [A] (For error pattern [B], go to step 10.)</p> <p>1) Slide the stopper of the microSD card 1 to the right to remove the card. → Mark the removed microSD card as unusable.</p> <p>2) Slide the stopper of the microSD card 2 to the right to remove the card.</p> <p>3) Insert the removed microSD card 2 into the card 1 slot.</p> <p>4) Insert a replacement microSD card (service part) into the card 2 slot. * Align the microSD card with the underside of the card slot, gently insert the microSD card until the stopper is put back in place.</p> <p>5) Go to step 11.</p>
10	<p>■ For error pattern [B]</p> <p>1) Slide the stopper of the microSD card 2 to the right to remove the card. → Mark the removed microSD card as unusable.</p> <p>2) Insert a replacement microSD card (service part) into the card 2 slot. * Align the microSD card with the underside of the card slot, gently insert the microSD card until the stopper is put back in place.</p>
11	Install the cover and the board in the order of steps 8, 7, (6, 5), 4, and 3.
12	<p>Install the AE-C back in its original location, reconnect the M-NET cables and other cables, and turn on the power. Check that the restoration process has started, referring to "3. STATUS LED indication after replacement of microSD cards." Wait for 90 minutes, and verify that the restoration process has completed and the controller is operating properly.</p> <p>*90 minutes = restoration process + startup time</p>

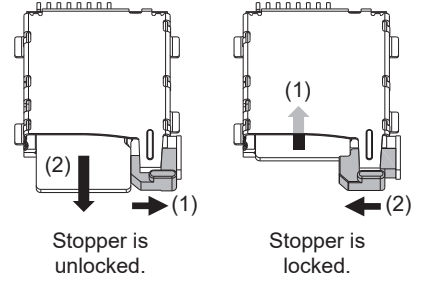
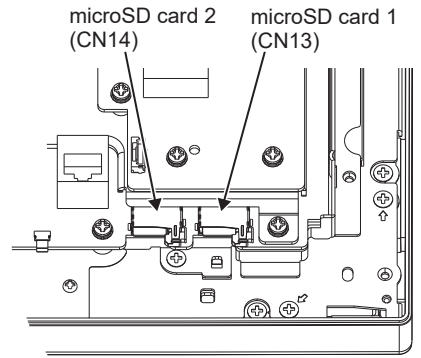

**NOTE:**

- For the method to check if the controller is operating properly after installed back in its original location, refer to the AE-C/EW-C Instruction Book (Detailed operations) or the BACS-AP50 Instruction Book (Detailed operations).
- Removed microSD cards cannot be reused.
- During restoration, all functions such as monitoring of air conditioning units, schedule, and billing are stopped.
- For tightening torques, refer to the AE-C/EW-C installation manual or the BACS-AP50 installation manual.

(2) Procedure for microSD card replacement on EW-C

When replacing the microSD cards due to malfunction or other reasons, follow the procedure below.

Note that two microSD cards (microSD card 1 and microSD card 2) are installed in the EW-C. The replacement procedure differs depending on the error location (shown in item 1 above).

Step	
1	Shut off the power to the EW-C, and check that the POWER LED on the front is off.
2	Disconnect all the cables (AC power cable, M-NET transmission cable, CN5, CN6, CN10). Remove the controller from the control box or bracket, and place it with the metal sheet side facing down.
3	Remove the mounting screw A (one screw) from the expansion slot cover.

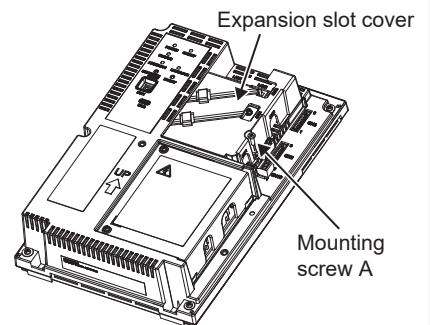

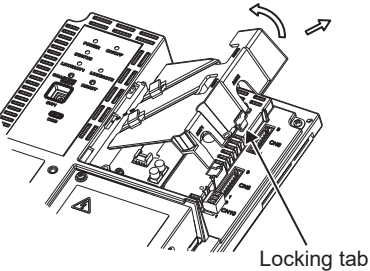
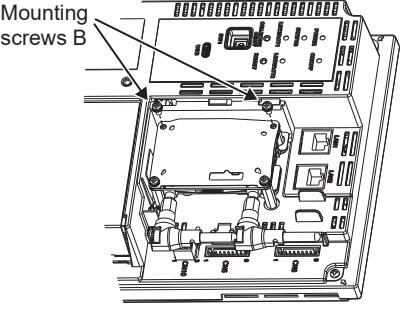
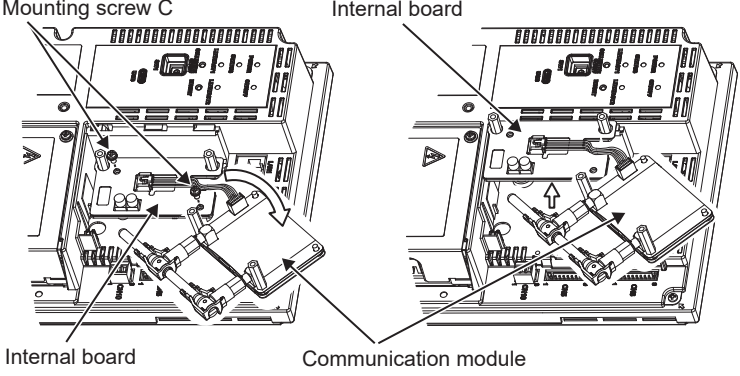
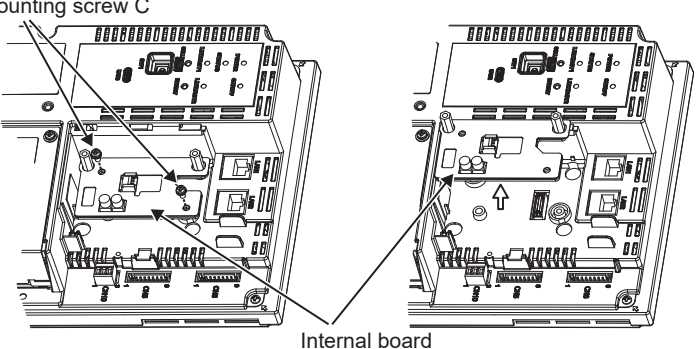
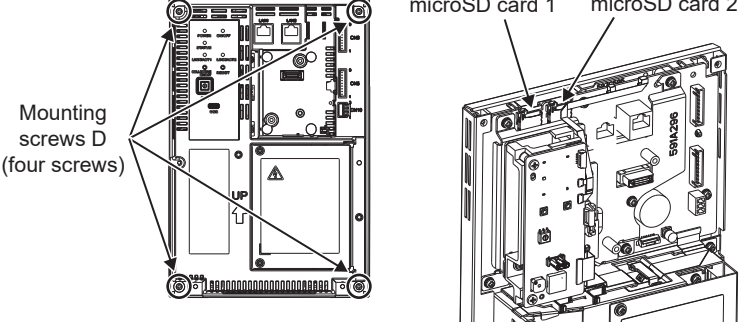
Step	
<p>4 Lift and remove the expansion slot cover while pushing the locking tab.</p> <ul style="list-style-type: none"> <li>• If the communication antenna is protruding from inside the cover, be careful not to apply any force or impact to the antenna.</li> <li>• If no communication antenna is installed, go to step 7.</li> </ul>	 <p>Locking tab</p>
<p>5 Remove the mounting screws B (two screws) from the board (communication module) to which the communication antenna is connected.</p>	 <p>Mounting screws B</p>
<p>6 (Perform the step below if a cellular communication board is mounted.) Turn the cellular communication board over as shown in the figure, remove the mounting screws C (two screws) from the internal board, and lift and remove the internal board. Go to step 8.</p>	 <p>Mounting screw C</p> <p>Internal board</p> <p>Internal board</p> <p>Communication module</p>
<p>7 Remove the mounting screws C (two screws) from the internal board, and lift and remove the internal board.</p>	 <p>Mounting screw C</p> <p>Internal board</p>
<p>8 Remove the mounting screws D (four screws) from the front panel, and remove the black cover. The SD card slots on the side of the controller will be visible.</p>	 <p>Mounting screws D (four screws)</p> <p>microSD card 1</p> <p>microSD card 2</p>

Step		
9	<p>■ For error pattern [A] (For error pattern [B], go to step 10.)</p> <ol style="list-style-type: none"> <li>1) Slide the stopper of the microSD card 1 to the right to remove the card. → Mark the removed microSD card as unusable.</li> <li>2) Slide the stopper of the microSD card 2 to the right to remove the card.</li> <li>3) Insert the removed microSD card 2 into the card 1 slot.</li> <li>4) Insert a replacement microSD card (service part) into the card 2 slot. * Align the microSD card with the underside of the card slot, gently insert the microSD card until the stopper is put back in place.</li> <li>5) Go to step 11.</li> </ol>	<p>microSD card 2 (CN14)      microSD card 1 (CN13)</p>
10	<p>■ For error pattern [B] (For error pattern [A], go to step 11.)</p> <ol style="list-style-type: none"> <li>1) Slide the stopper of the microSD card 2 to the right to remove the card. → Mark the removed microSD card as unusable.</li> <li>2) Insert a replacement microSD card (service part) into the card 2 slot. * Align the microSD card with the underside of the card slot, gently insert the microSD card until the stopper is put back in place.</li> </ol>	<p>Stopper is unlocked.      Stopper is locked.</p>
11	<p>Install the cover and the board in the order of steps 8, 7, (6, 5), 4, and 3.</p>	
12	<p>Install the EW-C back in its original location, reconnect the M-NET cables and other cables, and turn on the power. Check that the restoration process has started, referring to "3. STATUS LED indication after replacement of microSD cards." Wait for 90 minutes, and verify that the restoration process has completed and the controller is operating properly. *90 minutes = restoration process + startup time</p>	

**NOTE:**

- For the method to check if the controller is operating properly after installed back in its original location, refer to the AE-C/EW-C Instruction Book (Detailed operations) or the BACS-AP50 Instruction Book (Detailed operations).
- Removed microSD cards cannot be reused.
- During restoration, all functions such as monitoring of air conditioning units, schedule, and billing are stopped.
- For tightening torques, refer to the AE-C/EW-C installation manual or the BACS-AP50 installation manual.

**3. STATUS LED indication after replacement of microSD cards**

STATUS LED (Lighting color and state)		Operation status	Cause	Check procedure and remedy
Blinking in light blue	Normal	Upon detection of the replacement of the microSD card, the controller is restoring data.	–	Upon completion of the data restoration, the controller automatically restarts and resumes operation. *Data restoration takes up to 90 minutes.
Blinking in green	Error	After replacing the microSD card, an error has been detected in the insertion slot.	The replacement microSD card has not been inserted into the correct slot.	1) Check that the correct slot is used. 2) Check that the replacement microSD card is in the slot. 3) Insert the replacement card in the correct slot before turning on the power.
Blinking in orange	Error	After the controller was started, an error has been detected in the internal microSD card 1.	[microSD card 1 reading error] 1) An accidental malfunction prevented writing to or reading from the internal microSD card 1. 2) The internal microSD card 1 is disconnected.	See "[15] microSD card replacement - Restore overview".
Blinking in yellow	Error	After the controller was started, an error has been detected in the internal microSD card 2.	[microSD card 2 reading error] 1) An accidental malfunction prevented writing to or reading from the internal microSD card 2. 2) The internal microSD card 2 is disconnected.	See "[15] microSD card replacement - Restore overview".

# IV. Appendix

---

[1] How to Use Wireshark for AE-C/EW-C BACnet.....	75
1. Repeater hub.....	75
2. Port Mirroring.....	76
3. Wireshark Start.....	76
4. "Filter" on monitoring screen.....	80
5. Examples.....	81
6. Wireshark Stop.....	83
[2] Electrical Wiring Diagram.....	84
1. AE-C.....	84
2. EW-C.....	84

# IV. Appendix

## [1] How to Use Wireshark for AE-C/EW-C BACnet

Wireshark can capture BACnet® communication between the building management system and AE-C/EW-C. Download Wireshark: <http://www.wireshark.org/download.html>

### 1. Repeater hub

- It is required to use a repeater hub, or switching hub that features port mirroring (“Port Mirroring” setting is required to duplicate the communication data to other port) to intercept the communication between AE-C/EW-C and the building management system.
- Normal commercially available hubs are all switching hubs, but capturing the required packets is not possible because the packets sent to the AE-C/EW-C address or building management system address do not arrive at the PC for packet capture.
- Do not install Wireshark on the same PC as the building management system.

Connection example for repeater hub

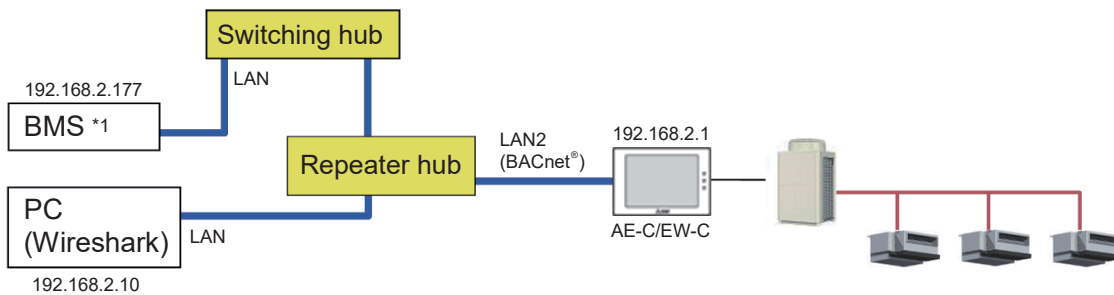

\*1 BMS: Building Management System

Connection example for switching hub with port mirroring feature

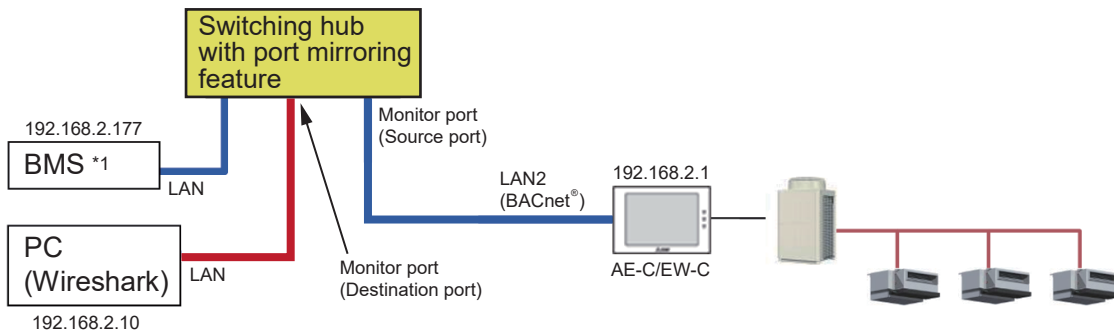

\*1 BMS: Building Management System

## 2. Port Mirroring

When using a switching hub that features port mirroring, configure the “Port Mirroring” setting. The setting example for Planex communication’s switching hub is shown below.



Configure the “Destination Port” setting for connecting the PC (Wireshark), and the “Source Port” setting for the monitoring target port. Multiple source ports can be selected.

If “Tx & Rx” is selected for “Monitored Packets”, both sending and receiving packets can be captured.

## 3. Wireshark Start

The images in this document may differ from the actual screens depending on the version of Wireshark used.

### (1) Menu: Capture -> Options

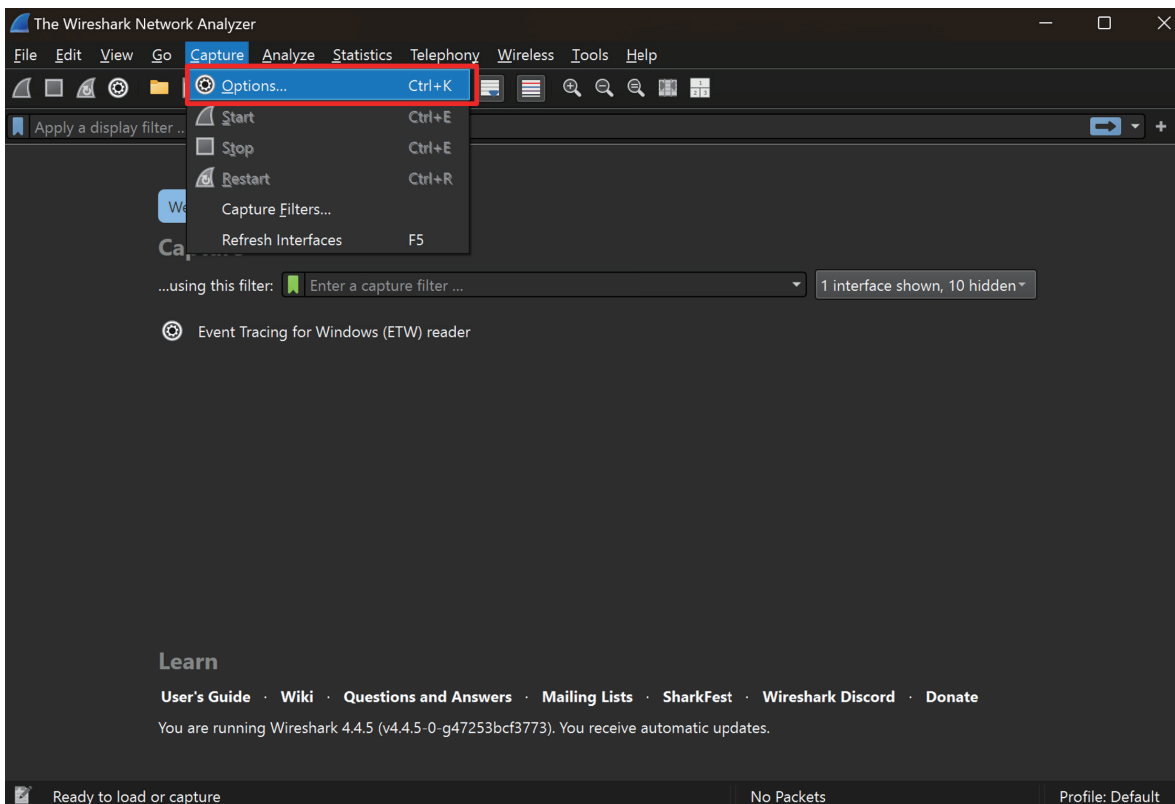

(2) Select the network interface and confirm the IP address.

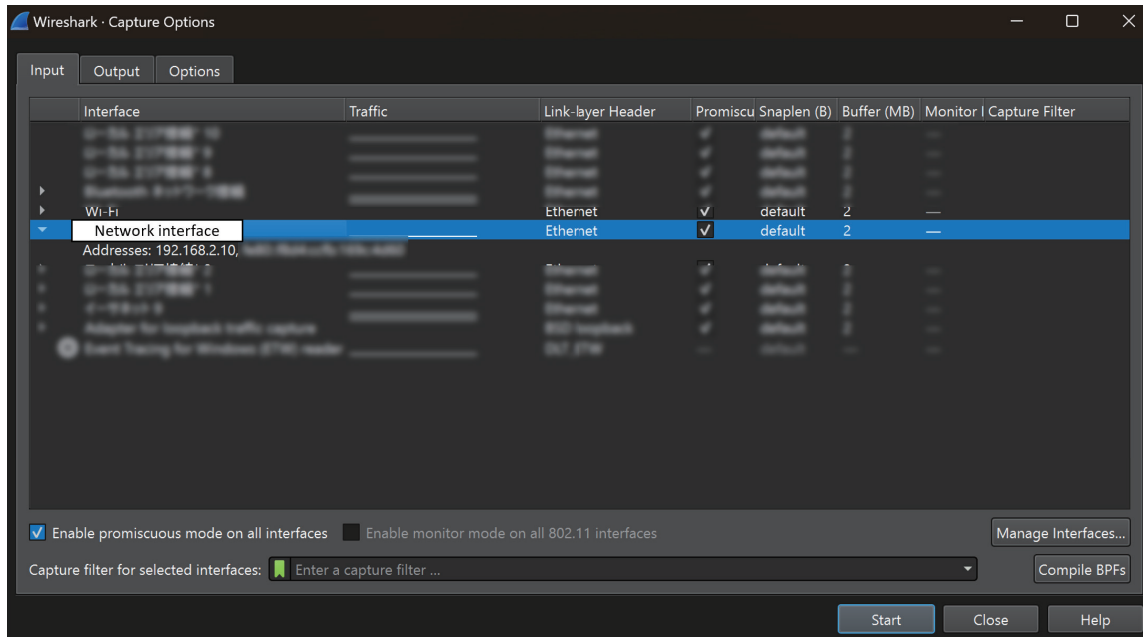

(3) "Capture Filter" setting (for limiting the recording data size)

- 1) Click  icon.
- 2) Click "Manage Capture Filters".

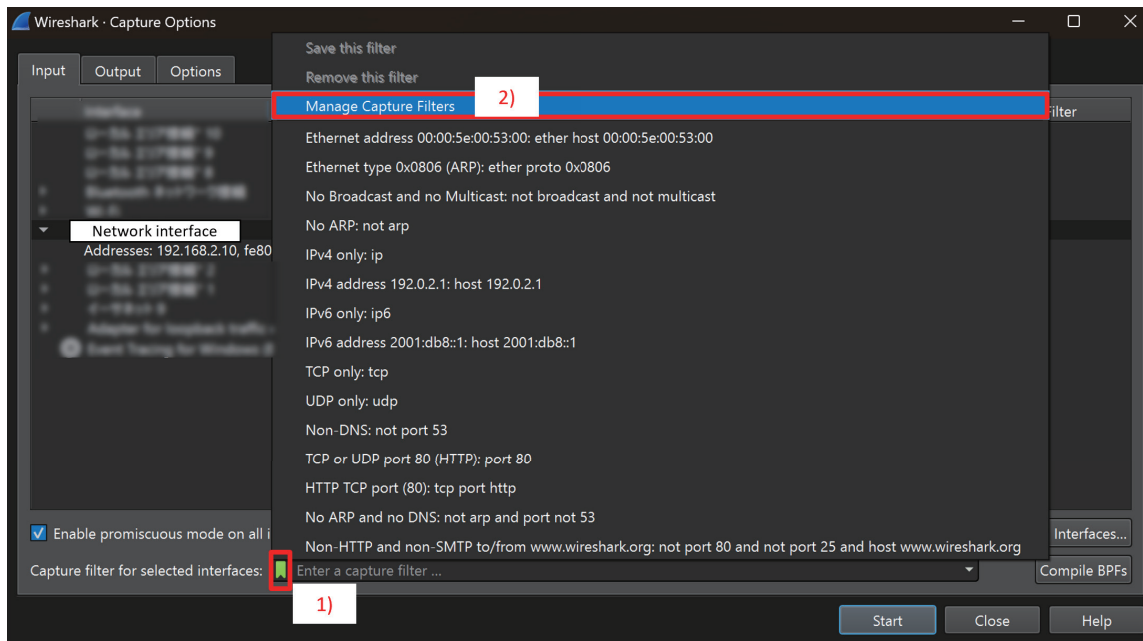

3) Click "+".

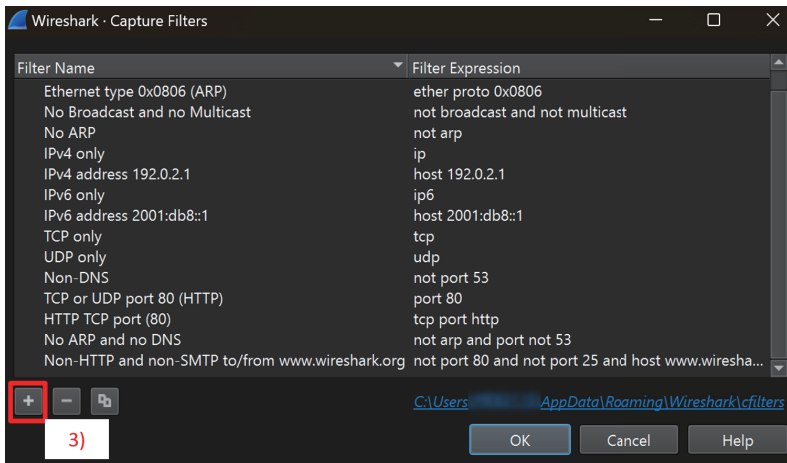

- 4) Input: "BACnet"  
"port 47808"  
\* "p" is lowercase.
- 5) Click "OK".

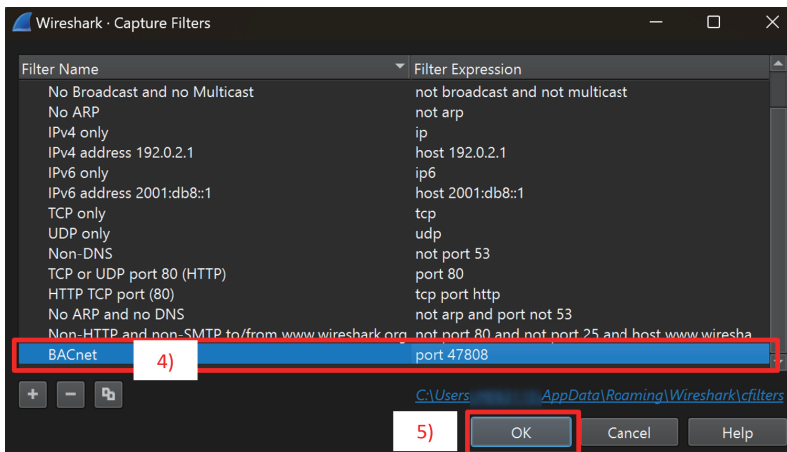

(4) "Capture Files" setting

- 1) Click "Output" tab.
- 2) Click "Browse...".  
Select the folder and input the file name. Adding ".pcapng" is recommended.  
Example) C:\tmp\test.pcapng
- 3) Check "Create a new file automatically.." is recommended.
- 4) Selecting "1 megabyte" is recommended.

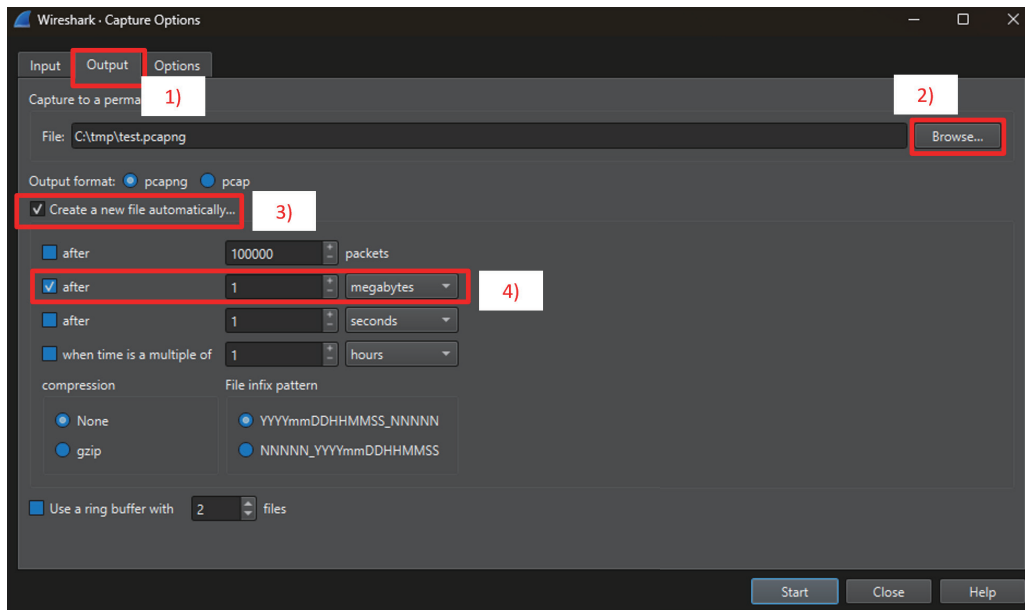

(5) Start capture

- 1) Click "Input" tab. Make sure the network interface is selected.
- 2) Click [green icon] and select "BACnet: port 47808".
- 3) Click "Start".

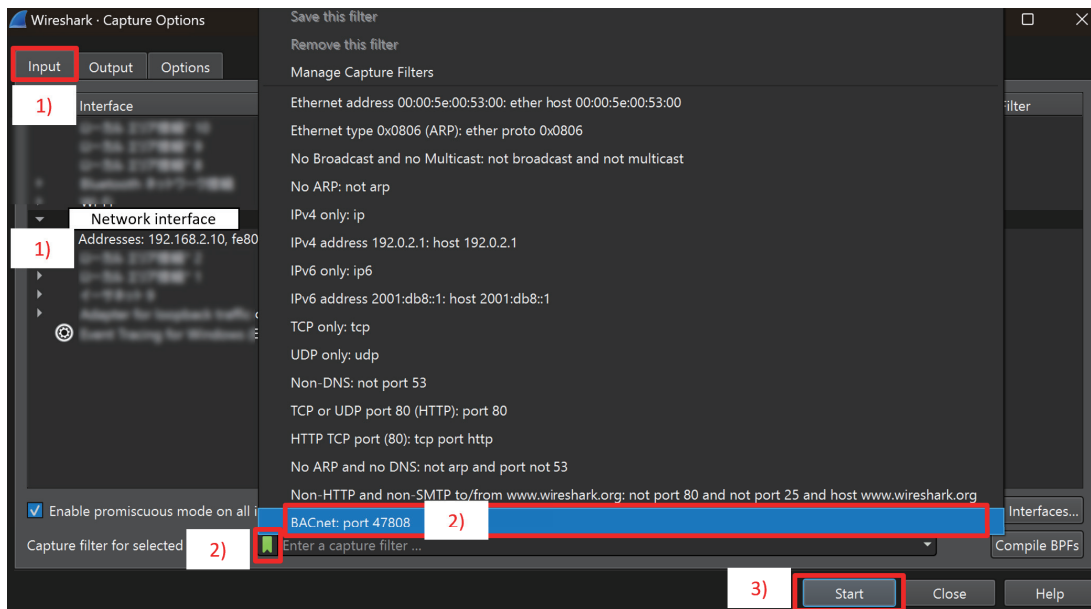

#### 4. “Filter” on monitoring screen

“Filter” on monitoring screen is for just limiting the display. (It does not affect to the recording data.)

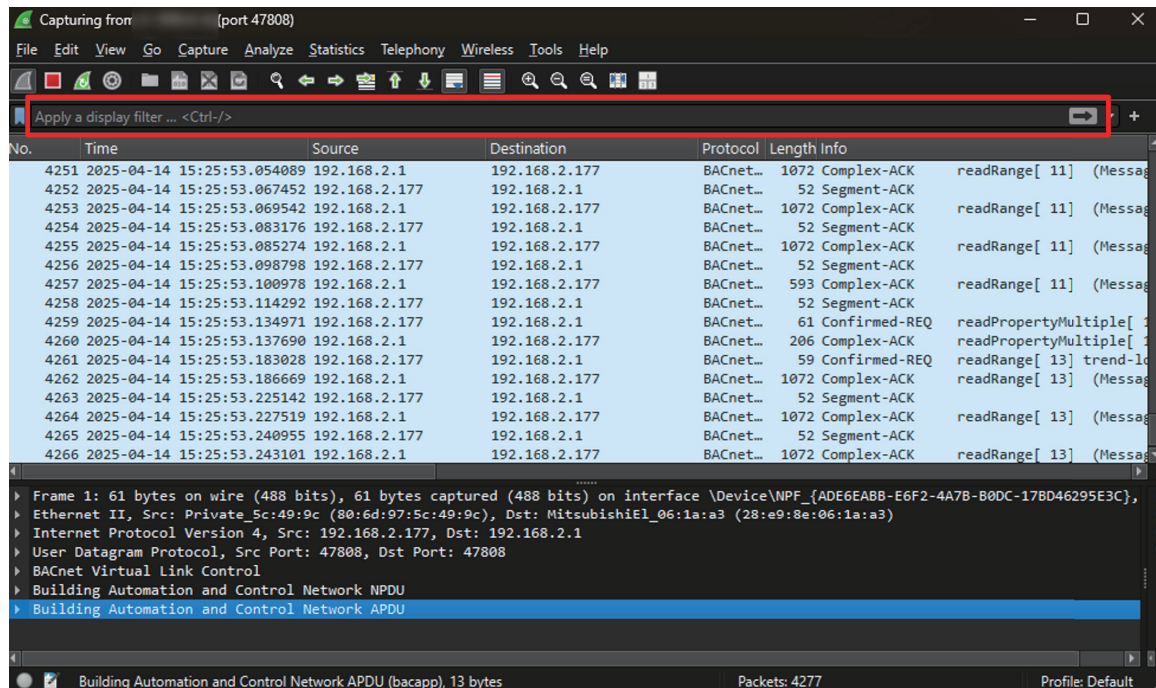

##### Filter examples

- Show only fixed device  
ip.addr == 192.168.2.1
- Show only fixed direction of communication  
ip.src == 192.168.2.1 and ip.dst == 192.168.2.2
- Show both direction of communication  
ip.src == 192.168.2.1 or ip.dst == 192.168.2.1
- Show only BACnet packet  
bvlc
- Show only the packet for a specific BACnet instance number  
bacapp.instance\_number == 10106
- Show only the packet for a specific BACnet object type  
bacapp.objectType == 0  
(For object type values, refer to section “Objects” in the AE-C/EW-C/BACS-AP50 Instruction Book (BACnet function).)

## 5. Examples

Example (1): When the “Operational Mode State” object is read out by the “ReadProperty” service

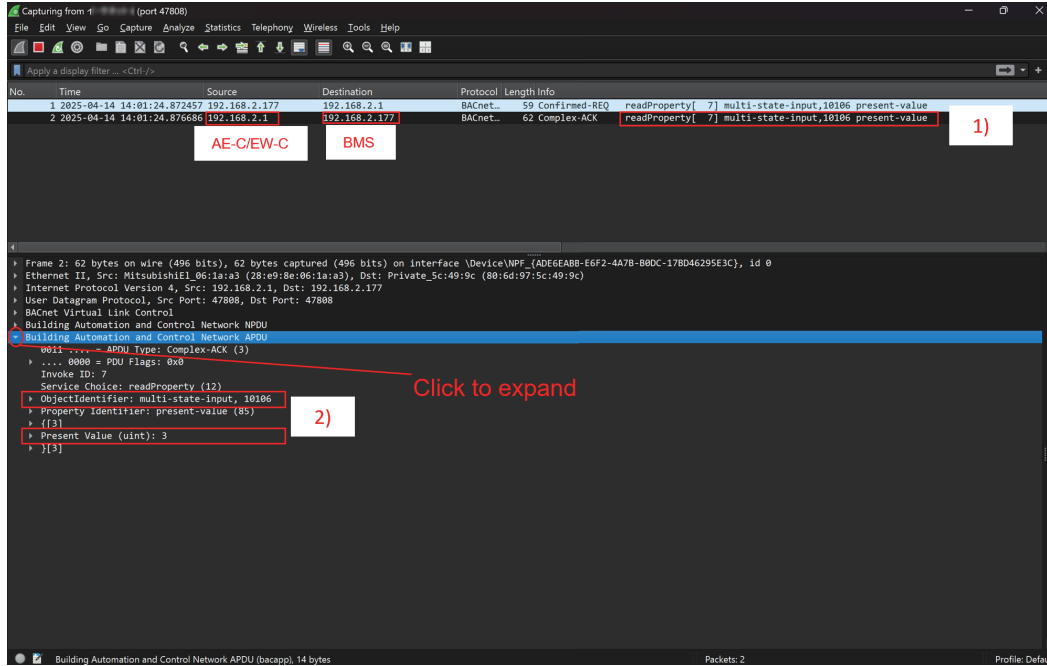

- 1) Confirm the response from AE-C/EW-C (192.168.2.1) to BMS (192.168.2.177).
- 2) Operation mode state (01xx06) of Group No.1:  
 Present value is 3 (= Fan).  
 (For the BACnet objects supported by AE-C/EW-C and the meanings of their instance numbers and present values, refer to section “Instance number for basic functions” in the AE-C/EW-C/BACS-AP50 Instruction Book (BACnet function).)

Example (2): When the “Room Temp” object is read out by the “ReadPropertyMultiple” service

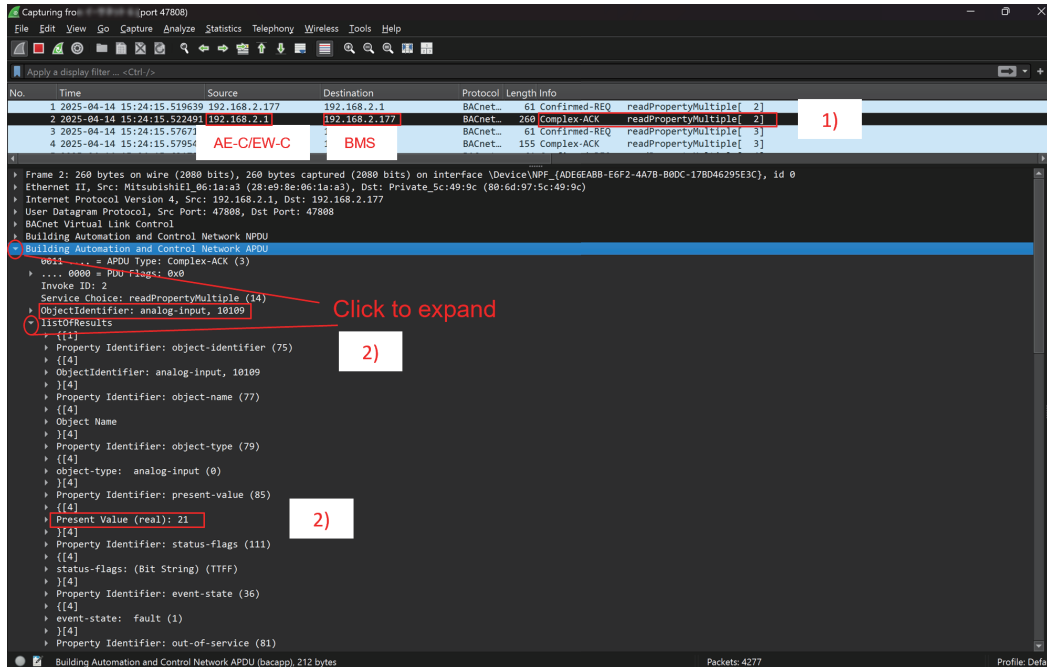

- 1) Confirm the response from AE-C/EW-C to BMS.
- 2) Room Temp (01xx09) of Group No.1:  
 Present value is 21.  
 (For the BACnet objects supported by AE-C/EW-C and the meanings of their instance numbers and present values, refer to section “Instance number for basic functions” in the AE-C/EW-C/BACS-AP50 Instruction Book (BACnet function).)

BACnet® display example (when no response from AE-C/EW-C)

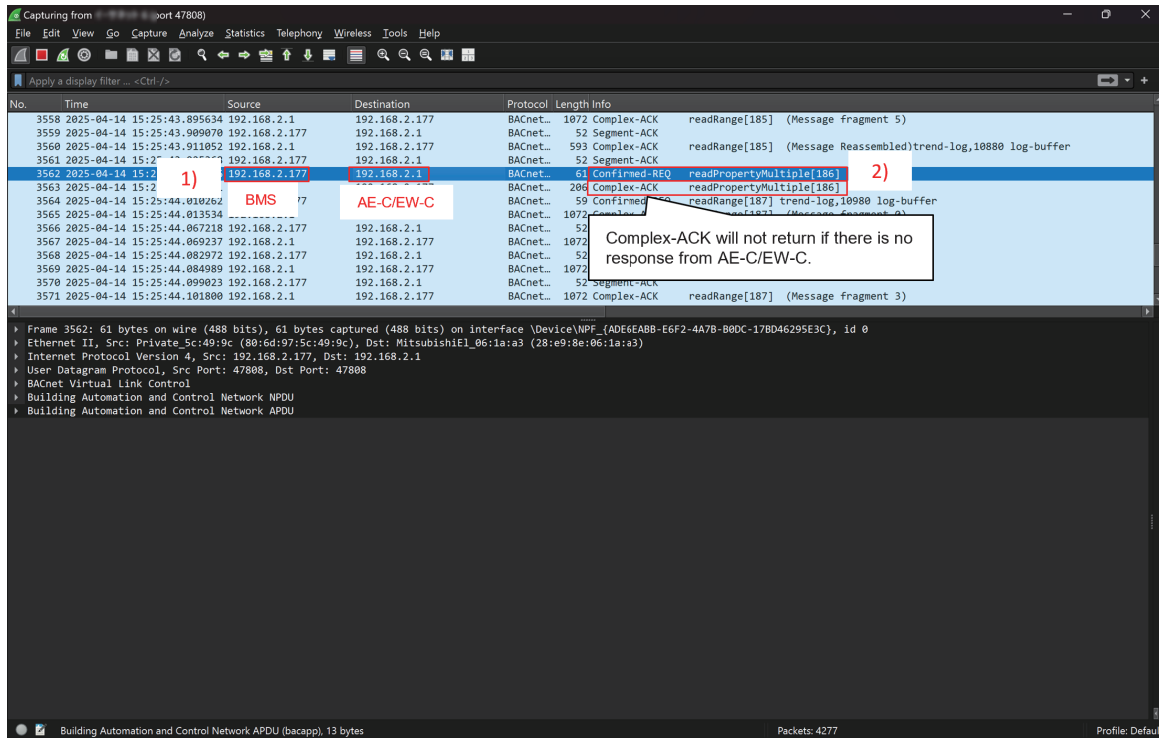

1) You can determine that the communication is from the BMS (192.168.2.177) to the AE-C/EW-C (192.168.2.1).

2) You can determine that this is a “ReadPropertyMultiple” service request.

(For BACnet service that AE-C/EW-C supports, refer to section “Services for each object” in the AE-C/EW-C/BACS-AP50 Instruction Book (BACnet function))

Since there are no response packets that have the same Invoke ID (value in the square bracket after the service name) as for the service request after the “ReadPropertyMultiple” service request indicated by 1) and 2), you can determine that a request was made from the BMS (Confirmed-REQ) but that there was no response from the AE-C/EW-C (Complex-ACK).

## 6. Wireshark Stop

### (1) Menu: Capture -> Stop

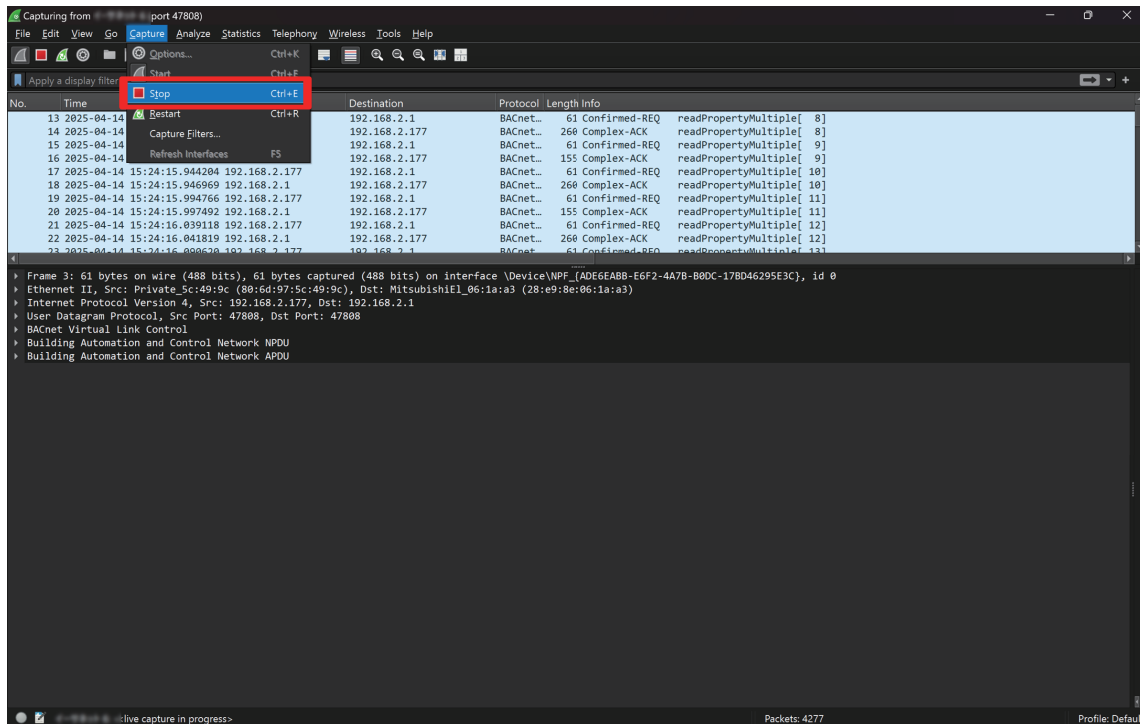

### (2) Save the captured result.

Menu: File -> Save As

## [2] Electrical Wiring Diagram

### 1. AE-C

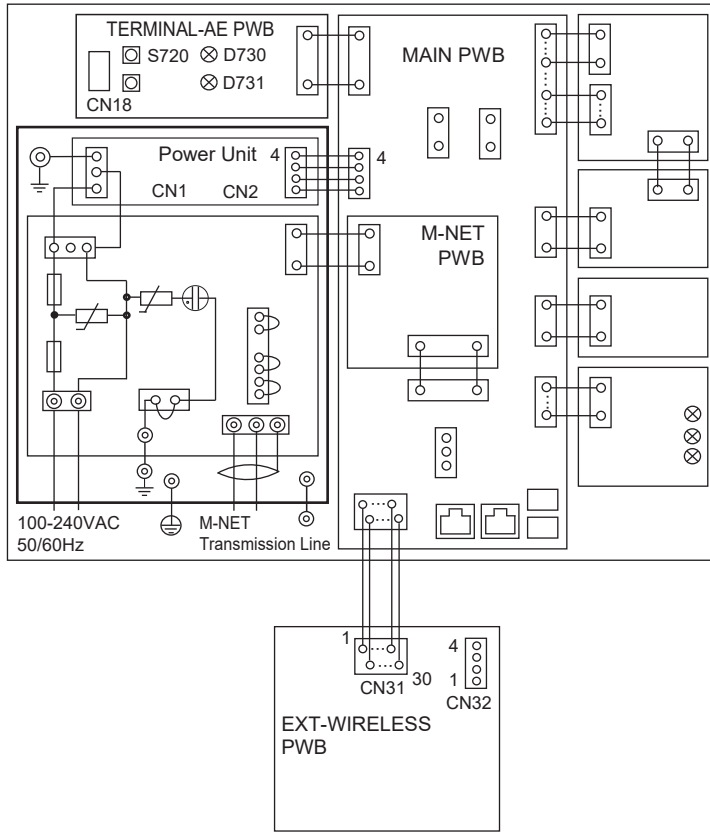

Symbol	Explanation
TB1	Terminal Block(Power Source)
TB3	Terminal Block (M-NET Transmission Line)
F900	Fuse(250VAC T6.3AH)
F901	Fuse(250VAC T2A)
D750	LED(POWER)
D751	LED(ON/OFF)
D752	LED(STATUS)
D730	LED (LINK/ACT1)
D731	LED (LINK/ACT2)
LAN1	Connector(LAN1)
LAN2	Connector(LAN2)
CN10	Connector(RS-485)
CN5	Connector( External I/O1)
CN6	Connector( External I/O2)
CN18	Connector(USB-C)
CN13	Connector(microSDcard1)
CN14	Connector(microSDcard2)
CN21	Connector(Power jumper)
S720	Switch (COLLECTIVE ON/OFF)
S721	Switch(RESET)

IV. Appendix

### 2. EW-C

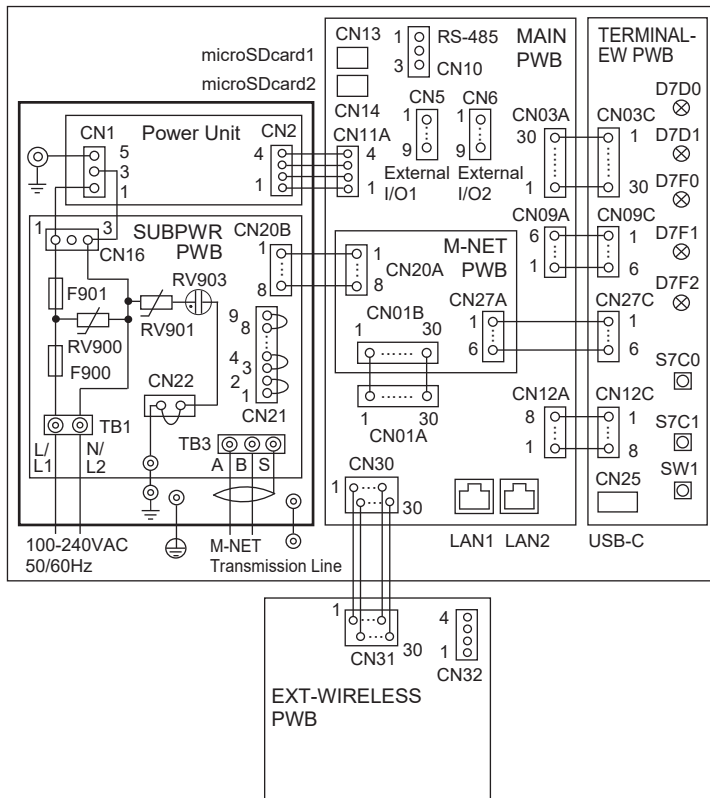

Symbol	Explanation
TB1	Terminal Block(Power Source)
TB3	Terminal Block (M-NET Transmission Line)
F900	Fuse(250VAC T6.3AH)
F901	Fuse(250VAC T2A)
D7F0	LED(POWER)
D7F1	LED(ON/OFF)
D7F2	LED(STATUS)
D7D0	LED(LINK/ACT1)
D7D1	LED(LINK/ACT2)
LAN1	Connector(LAN1)
LAN2	Connector(LAN2)
CN10	Connector(RS-485)
CN5	Connector( External I/O1)
CN6	Connector( External I/O2)
CN25	Connector(USB-C)
CN13	Connector(microSDcard1)
CN14	Connector(microSDcard2)
CN21	Connector(Power jumper)
SW1	Switch (IP Address Setting LAN1)
S7C0	Switch (COLLECTIVE ON/OFF)
S7C1	Switch(RESET)







# **mitsubishi electric corporation**

[www.MitsubishiElectric.com](http://www.MitsubishiElectric.com)

---